

# Cardio

Thorax-Herz-Gefäß-Chirurgie  
Thoracic and Cardiovascular Surgery  
Cirugía torácica y cardiovascular  
Chirurgie thoracique et cardiovasculaire  
Chirurgia toracica e cardio-vascolare

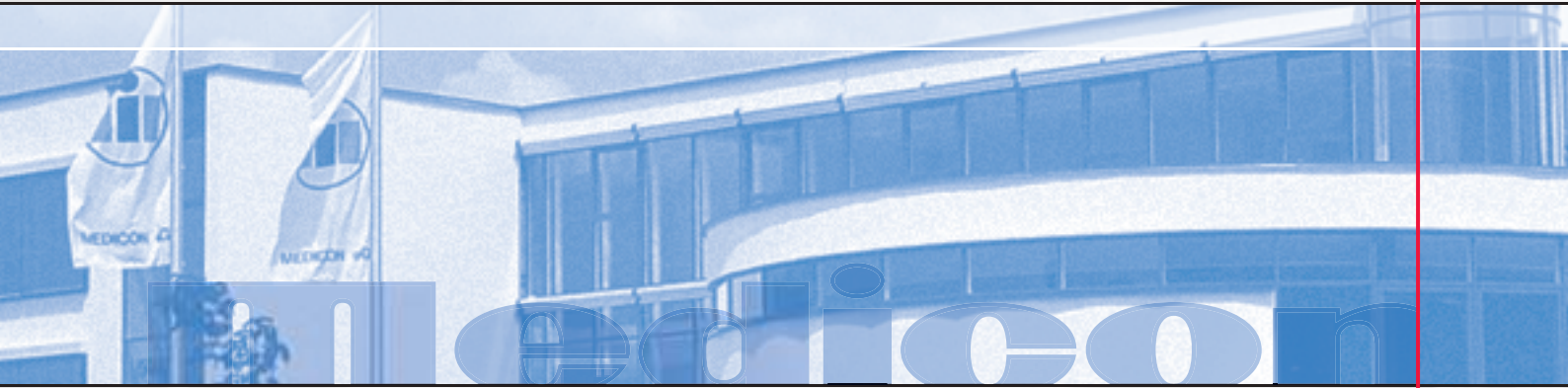

**Cardio**  
**Thorax-Herz-Gefäß-Chirurgie**  
**Thoracic and Cardiovascular Surgery**  
**Cirugía torácica y cardiovascular**  
**Chirurgie thoracique et cardiovasculaire**  
**Chirurgia toracica e cardio-vascolare**

<b>1</b>	Scheren Scissors Tijeras Ciseaux Forbici	1 - 40
<b>2</b>	Pinzetten Forceps Pinzas Pinces Pinze	41 - 64
<b>3</b>	Sauginstrumente Suction Instruments Instrumentos de aspiración Instruments à aspiration Strumenti d'aspirazione	65 - 70
<b>4</b>	Instrumente für Krampfadern, Venen und Endarterektomie Instruments for Varicose Veins, Vein and Endarterectomy Instrumentos para varices, venas y endarterectomía Instruments pour varices, veines et endartérectomie Strumenti per varici, vene ed endarterectomia	71 - 76
<b>5</b>	Gefäßspatel Vascular Spatulas Espátulas vasculares Spatules vasculaires Spatole vascolare	77 - 80
<b>6</b>	Nadelhalter Needle Holders Porta-agujas Porte-aiguilles Port'aghi	81 - 98
<b>7</b>	Drahtinstrumente · Knochendrähte Wire Instruments · Bone Suturing Wires Instrumentos para alambre · Alambres para huesos Instruments pour fils métalliques · Fils d'acier à os Strumenti per fili d'acciaio · Filo d'acciaio per ossa	99 - 104
<b>8</b>	Gefäßclips Vessel Clips Clips vasculares Clips vasculaires Clip vascolari	105 - 118
<b>9</b>	Klemmen · Atraumatische Klemmen Forceps · Atraumatic Clamps Pinzas · Pinzas atraumáticas Pinces · Pinces atraumatiques Pinze · Pinze atraumatiche	119 - 198
<b>10</b>	Gewebefasszangen Tissue Grasping Forceps Pinzas para agarrar tejidos Pinces pour saisir le tissu Pinze per afferrare tessuto	199 - 204
<b>11</b>	Gefäßhäkchen · Wundhaken Vessel Hooks · Retractors Ganchos para vasos · Separadores Crochets pour vaisseaux · Ecarteurs Uncinetti vascolari · Divaricatori	205 - 234

<b>12</b>	<b>Wundspreizer</b> <b>Self-retaining Retractors</b> <b>Separadores autoestáticos</b> <b>Ecarteurs autostatiques</b> <b>Divaricatori autostatici</b>	<b>235 - 240</b>
<b>13</b>	<b>Raspatorien</b> <b>Raspatories</b> <b>Legras</b> <b>Rugines</b> <b>Periostotomi</b>	<b>241 - 246</b>
<b>14</b>	<b>Hohlmeißelzangen · Knochensplitterzangen</b> <b>Bone Rongeurs · Bone Cutting Forceps</b> <b>Pinzas-gubias · Pinzas cortantes para huesos</b> <b>Pinces-gouges · Pinces coupantes à os</b> <b>Pinze-sgorbie · Pinze ossivore</b>	<b>247 - 254</b>
<b>15</b>	<b>Knochenhalte­zangen · Rippenscheren</b> <b>Bone Holding Forceps · Rib Shears</b> <b>Pinzas prensoras de huesos · Costótomos</b> <b>Daviers à os · Costotomes</b> <b>Pinze affera ossa · Costotomi</b>	<b>255 - 262</b>
<b>16</b>	<b>Rippenspreizer · Sternumspreizer</b> <b>Rib Spreaders · Sternal Retractors</b> <b>Separadores para costillas · Separadores para esternón</b> <b>Ecarteurs costaux · Ecarteurs pour sternum</b> <b>Divaricatori costali · Divaricatori sternali</b>	<b>263 - 296</b>
<b>17</b>	<b>Dilatatoren · Tourniquets</b> <b>Dilators · Tourniquets</b> <b>Dilatadores · Torniquetes</b> <b>Dilatateurs · Tourniquets</b> <b>Dilatatori · Tourniquets</b>	<b>297 - 300</b>
<b>18</b>	<b>Tunnelierbesteck · Aortastanzen · Valvulotome</b> <b>Tunneling Set · Aorta Punches · Valvulotomes</b> <b>Juego de instrumentos para tunelización · Perforadores para aorta · Valvulotomos</b> <b>Jeu pour tunnelisation · Perforateurs pour l'aorte · Valvulotomes</b> <b>Set per tunnelizzazione · Perforatori per aorta · Valvulòtomi</b>	<b>301 - 306</b>
<b>19</b>	<b>Sieb­vor­schlä­ge</b> <b>Set Suggestions</b> <b>Proposición de juegos</b> <b>Propositions de boîtes</b> <b>Proposte di set</b>	<b>307 - 318</b>
<b>20</b>	<b>Zubehör</b> <b>Accessories</b> <b>Accesorios</b> <b>Accessoires</b> <b>Accessori</b>	<b>319 - 322</b>
<b>21</b>	<b>Numerischer Index</b> <b>Numerical Index</b> <b>Indice numérico</b> <b>Index numérique</b> <b>Indice numérico</b>	<b>323 - 336</b>
<b>22</b>	<b>Alphabetischer Index</b> <b>Alphabetical Index</b> <b>Indice alfabético</b> <b>Index alphabétique</b> <b>Indice alfabético</b>	<b>337 - 365</b>



the art of





s u r g e r y



[www.medicon.de](http://www.medicon.de)

*made in Germany*

Der Ihnen vorliegende MEDICON-Katalog „Cardio“ bleibt unser Eigentum, auch wenn eine Leih- oder Schutzgebühr bezahlt wurde. Er darf nur zum Einkauf und Vertrieb der darin beschriebenen MEDICON-Produkte durch den dazu autorisierten Fachhandel und für die Bedarfsbeschaffung durch den jeweiligen Anwender verwendet werden. Seine Verwendung gegen unsere Interessen berechtigt uns zur sofortigen Rückforderung und möglichen weitergehenden Maßnahmen. Ohne unsere ausdrückliche, schriftliche Genehmigung darf dieser Katalog weder im Gesamten noch auszugsweise nachgedruckt oder kopiert werden.

This present MEDICON “Cardio” catalogue remains exclusively our property even if a lending fee or charge has been paid for it. It shall be used only by specialized dealers to buy and sell MEDICON products or by individual users to meet their own requirements. In case of misuse we are entitled to recall the catalogue immediately and to take further steps if necessary. It is not allowed to reprint or copy this catalogue in whole or partially without our written permission.

El presente catálogo MEDICON “Cardio” queda de nuestra propiedad aunque si han pagados ciertos derechos de préstamo de custodia. A los revendedores autorizados del ramo debe servir exclusivamente para la compra y la distribución de los productos MEDICON que describe y a los especialistas y usuarios particulares para escoger los instrumentos necesarios para su abastecimiento. Su empleo abusivo en perjuicio de nuestros intereses, nos da derecho a exigir su restitución inmediata y a tomar todas las medidas ulteriores que juzguemos necesarias. Salvo nuestro permiso expreso por escrito, quedan prohibidas la reproducción tipográfica o por calgador, tanto en total como en extractos.

Le présent catalogue “Cardio” de MEDICON demeure notre propriété, même après le paiement d’une taxe autorisée ou taxe de prêt. Il ne peut être utilisé que pour l’achat ou la vente des produits qui y sont décrits, par des spécialistes y étant autorisés et par l’utilisateur correspondant pour l’approvisionnement de ses besoins. Son utilisation contre nos intérêts nous autorise à une demande en restitution immédiate et à la prise éventuelle de mesures allant plus loin. Sans autorisation formelle écrite, ce catalogue ne peut être ni réimprimé, ni copié, que ce soit complètement ou partiellement.

Il presente catalogo MEDICON “Cardio” rimane di nostra proprietà anche se é stato pagato un diritto di noleggio o di proprietà riservata. Esso può essere adoperato soltanto per l’acquisto e la vendita dei prodotti MEDICON ivi descritti attraverso il commercio specializzato e autorizzato o per l’approvvigionamento tramite chi, di volta in volta, l’impiega. L’uso del catalogo contro i nostri interessi ci autorizza al suo immediato ritiro e possibili ulteriori provvedimenti. Senza la nostra esplicita autorizzazione scritta questo catalogo non può essere ristampato o copiato nè integralmente nè parzialmente.

Modelländerungen vorbehalten  
Patterns are subject to change  
Salvo modificaciones  
Tous droits réservés des changements de modèle  
Ci riserviamo la facoltà dei cambiamenti dei modelli

Gedruckt in der Bundesrepublik Deutschland  
Printed in Germany  
Impreso en la República Federal de Alemania  
Imprimé en Allemagne  
Stampato in R.F.G.  
Trykt i Tyskland  
© Copyright 11/2003, MEDICON eG, Tuttlingen, Germany

medicon

Scheren  
Scissors  
Tijeras  
Ciseaux  
Forbici





# standard

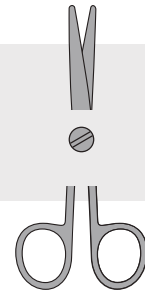

1

Jede Schere von Medicon trägt ihre individuelle Handschrift. Von **“standard”** bis **“magic cut”** - alle Scheren werden von fachkundigen Chirurgiemechanikern hergestellt, für dauerhafte Leistung sorgfältig gehärtet und qualitätsgerecht geprüft. Die besonderen Eigenschaften unserer Sondermodelle sind auf den Folgeseiten dargestellt.

All Medicon scissor have their own personal trademark. Starting with **“standard”** up to **“magic cut”** - all scissors are manufactured by experienced professionals, they are thoroughly hardened to ensure a long-lasting performance and quality-checked. The specific characteristics of our special models are explained on the following pages.

Cada tijera de Medicon lleva su propia escritura. Desde tijeras **“standard”** hasta **“magic cut”** - todas las tijeras son fabricadas por expertos competentes. Las tijeras son templadas e investigadas respecto a la calidad para un durable rendimiento. Las características de los modelos especiales son mencionadas en las páginas siguientes.

Tous les ciseaux de Medicon portent leurs caractéristiques individuelles. De **“standard”** à **“magic cut”** - tous les ciseaux sont fabriqués par des mécaniciens de chirurgie compétents, sont trempés soigneusement afin d’obtenir une performance durable et passent un contrôle de qualité d’un niveau très élevé. Les caractéristiques particulières de nos modèles spéciaux sont décrites sur les pages suivantes.

Ogni forbice marcata Medicon ha il suo carattere particolare. Dalla **“standard”** alla **“magic cut”** - tutte le forbici vengono prodotte da meccanici chirurgici specializzati. Per una lunga durata vengono temprate accuratamente e devono passare il controllo di qualità. Sulle prossime pagine vengono illustrate le particolarità dei nostri modelli esclusivi.

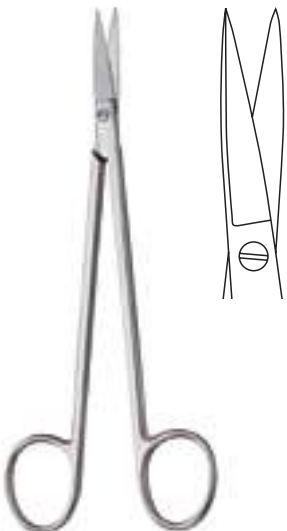

16 cm - 6¼"  
**Kelly**

standard <b>04.54.16</b>
supercut <b>204.54.16</b>
black line <b>214.54.16</b>
"HM" <b>04.54.66</b>
supercut plus <b>204.54.66</b>
magic cut <b>224.54.66</b>

Darstellungsbeispiel einer 16 cm Kelly-Schere, lieferbar in 6 Modellvarianten.

Example of a pair of Kelly Scissors 16 cm, which is available in 6 different models.

Ejemplo de una tijera Kelly 16 cm, disponible en 6 modelos diferentes.

Exemple d'une paire de ciseaux Kelly 16 cm, dont 6 modèles différents sont livrables.

Esempio di una forbice Kelly 16 cm, fornibile in 6 differenti modelli.



# supercut

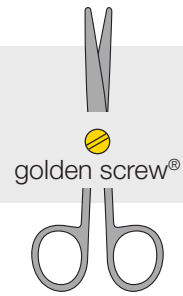

Kennzeichen: goldene Schraube  
Characteristic: golden screw  
Característica: tornillo dorado  
Caractéristique: vis dorée  
Caratteristica: vite dorata

Messerschliiff und Mikroverzahnung  
Knife edges and micro serration  
Hoja de bisturí y dentadura micro  
Aiguisement tranchant et dents micro  
Affilatura a scalpello e dentellatura micro

Feiner, minimal traumatisierender Schnitt  
Fine, minimally traumatizing cut  
Corte fino, mínimo traumático  
Coupe fine, minimalement traumatisante  
Taglio fine, minimo traumatizzante



1



**black line**

Kennzeichen: goldene Schraube, schwarze Ringgriffe  
Characteristics: golden screw, black rings  
Característica: tornillo dorado, anillos negros  
Caractéristiques: vis dorée, anneaux noirs  
Caratteristica: vite dorata, anelli neri



Messerschliff und Mikroverzahnung  
Knife edges and micro serration  
Hoja de bisturí y dentadura micro  
Aiguisement tranchant à dents micro  
Affilatura a scalpello e dentellatura micro

Feiner, minimal traumatisierender Schnitt  
Fine, minimally traumatizing cut  
Corte fino, mínimo traumático  
Coupe fine, minimalement traumatisante  
Taglio fine, minimo traumatizzante

Zusätzlicher Anschliff einer Blattrückseite  
Additional ground section of one blade's backside  
Afilado adicional de la parte posterior de una hoja  
Aiguisement supplémentaire transversal  
Riduzione del taglio trasversale

Bessere Sicht  
Better visibility  
Mejor visión  
Vue améliorée  
Migliore visione

Präzise Präparation  
Precise preparation  
Preparación precisa  
Préparation précise  
Preparazione precisa



## "HM"

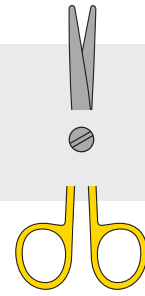

Kennzeichen: goldene Ringgriffe  
Characteristic: golden rings  
Característica: anillos dorados  
Caractéristique: anneaux dorés  
Caratteristica: anelli dorati

1



Eingeschweißte Hartmetallschneiden  
Welded cutting edges  
Hojas soldadas de tungsteno  
Lames soudées d'un alliage de chrome-tungstène  
Lame saldate al tungsteno

Nahtlose, homogene Verbindung von Hartmetall und Scherenstahl  
Seamless, homogenous junction of tungsten carbide and scissors steel  
Unión homogénea del tungsteno con el acero  
Jointure sans traces et homogène du tungstène avec l'acier des ciseaux  
Congiunzione omogenea con l'acciaio delle forbici senza cordolo del tungsteno

Keine zur Rostbildung neigende Lötnaht  
Corrosion-free welding seam  
Sin soldadura que podría tender a corrosión  
Pas de soudure qui pourrait rouiller  
Senza saldatura che possa tendere ad arrugginire

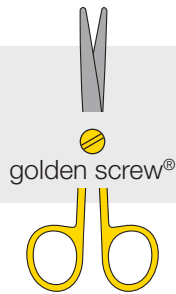

**supercut plus**



Kennzeichen: goldene Schraube, goldene Ringgriffe  
 Characteristics: golden screw, golden rings  
 Característica: tornillo dorado, anillos dorados  
 Caractéristiques: vis dorée, anneaux dorés  
 Caratteristiche: vite dorata, anelli dorati

Messerschleif und Mikroverzahnung  
 Knife edges and micro serration  
 Hoja de bisturí y dentadura micro  
 Aiguisement tranchant à dents micro  
 Affilatura a scalpello e dentellatura micro

Feiner, minimal traumatisierender Schnitt  
 Fine, minimally traumatizing cut  
 Corte fino, mínimo traumático  
 Coupe fine, minimalement traumatisante  
 Taglio fine, minimo traumatizzante

Eingeschweißte Hartmetallschneiden  
 Welded cutting edges  
 Hojas soldadas de tungsteno  
 Lames soudées d'un alliage de chrome-tungstène  
 Lame saldate al tungsteno

Nahtlose, homogene Verbindung von Hartmetall und Scherenstahl  
 Seamless, homogenous junction of tungsten carbide and scissors steel  
 Unión homogénea del tungsteno con el acero  
 Jointure sans traces et homogène du tungstène avec l'acier des ciseaux  
 Congiunzione omogenea con l'acciaio delle forbici senza cordolo del tungsteno

Keine zur Rostbildung neigende Lötnaht  
 Corrosion-free welding seam  
 Sin soldadura que podría tender a corrosión  
 Pas de soudure qui pourrait rouiller  
 Senza saldatura che possa tendere ad arrugginire

Zusätzlicher Anschliff einer Blattrückseite  
 Additional ground section of one blade's backside  
 Afilado adicional de la parte posterior de una hoja  
 Aiguisement supplémentaire transversal  
 Riduzione del taglio trasversale

Bessere Sicht  
 Better visibility  
 Mejor visión  
 Vue améliorée  
 Migliore visione

Präzise Präparation  
 Precise preparation  
 Preparación precisa  
 Préparation précise  
 Preparazione precisa



1



# magic cut



Kennzeichen: schwarzes Finish, goldene Schraube  
 Characteristics: black finish, golden screw  
 Característica: superficie negra, tornillo dorado  
 Caractéristiques: finition noire, vis dorée  
 Caratteristica: finitura nera, vite dorata

1

Messerschleif und Mikroverzahnung  
 Knife edges and micro serration  
 Hoja de bisturí y dentadura micro  
 Aiguisement tranchant à dents micro  
 Affilatura a scalpello e dentellatura micro

Feiner, minimal traumatisierender Schnitt  
 Fine, minimally traumatizing cut  
 Corte fino, mínimo traumático  
 Coupe fine, minimalement traumatisante  
 Taglio fine, minimo traumatizzante

Eingeschweißte Hartmetallschneiden  
 Welded cutting edges  
 Hojas soldadas de tungsteno  
 Lames soudées d'un alliage de chrome-tungstène  
 Lame saldate al tungsteno

Nahtlose, homogene Verbindung von Hartmetall und Scherenstahl  
 Seamless, homogenous junction of tungsten carbide and scissors steel  
 Unión homogénea del tungsteno con el acero  
 Jointure sans traces et homogène du tungstène avec l'acier des ciseaux  
 Congiunzione omogenea con l'acciaio delle forbici senza cordolo del tungsteno

Keine zur Rostbildung neigende Lötnaht  
 Corrosion-free welding seam  
 Sin soldadura que podría tender a corrosión  
 Pas de soudure qui pourrait rouiller  
 Senza saldatura che possa tendere ad arrugginire

Zusätzlicher Anschliff einer Blattrückseite  
 Additional ground section of one blade's backside  
 Afilado adicional de la parte posterior de una hoja  
 Aiguisement supplémentaire transversal  
 Riduzione del taglio trasversale

Bessere Sicht  
 Better visibility  
 Mejor visión  
 Vue améliorée  
 Migliore visione

Präzise Präparation  
 Precise preparation  
 Preparación precisa  
 Préparation précise  
 Preparazione precisa



Keramikbeschichtung  
 Ceramic coating  
 Recubrimiento de cerámica  
 Couche céramique  
 Rivestimento di ceramica

Hohe Oberflächenhärte  
 High surface hardness  
 Alta dureza de la superficie  
 Grande dureté de la surface  
 Alta durezza della superficie

Lange Standzeit  
 Long lasting cutting ability  
 Alta permanencia del corte  
 Longue durée de vie  
 Lunga durata

Hervorragende Gleitfähigkeit  
 Excellent sliding capacity  
 Deslizamiento destacado  
 Glissement excellent  
 Eccellente scorrimento

Blendfreie Oberfläche  
 Non-dazzling surface  
 Superficie antideslumbrante  
 Surface non-éblouissante  
 Superficie antiriflesso

**Feine Scheren**  
**Delicate Scissors**  
**Tijeras finas**  
**Ciseaux délicats**  
**Forbici delicate**



11,5 cm - 4½"

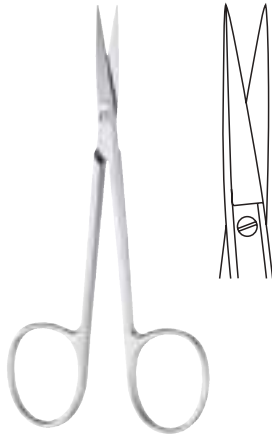

- standard  
**02.20.11**
- supercut  
**202.20.11**
- black line  
**212.20.11**
- "HM"  
**02.20.61**
- supercut plus  
**202.20.61**
- magic cut  
**222.20.61**

11,5 cm - 4½"



- standard  
**02.21.11**
- supercut  
**202.21.11**
- black line  
**212.21.11**
- "HM"  
**02.21.61**
- supercut plus  
**202.21.61**
- magic cut  
**222.21.61**

1

11,5 cm - 4½"



- standard  
**02.50.12**
- supercut  
**202.50.12**
- black line  
**212.50.12**
- magic cut  
**222.50.62**

**Stevens**

11,5 cm - 4½"



- standard  
**02.50.13**
- supercut  
**202.50.13**
- black line  
**212.50.13**
- magic cut  
**222.50.63**

**Stevens**





**Feine Scheren**  
**Delicate Scissors**  
**Tijeras finas**  
**Ciseaux délicats**  
**Forbici delicate**

1



11,5 cm – 4½"

supercut  
**204.10.11**

"HM"  
**04.10.61**

magic cut  
**224.10.61**

Unterminierscheren  
 Undermining scissors  
 Tijeras para tunelización  
 Ciseaux à tunnelisation  
 Forbici per tunnelizzare

**Siegert**



11,5 cm – 4½"

supercut  
**204.11.11**

"HM"  
**04.11.61**

magic cut  
**224.11.61**

**Siegert**



16 cm – 6¼"

standard  
**04.54.16**

supercut  
**204.54.16**

black line  
**214.54.16**

"HM"  
**04.54.66**

supercut plus  
**204.54.66**

magic cut  
**224.54.66**

**Kelly**



16 cm – 6¼"

standard  
**04.55.16**

supercut  
**204.55.16**

black line  
**214.55.16**

"HM"  
**04.55.66**

supercut plus  
**204.55.66**

magic cut  
**224.55.66**

**Kelly**



**03.02.84**  
14,5 cm – 5¾"

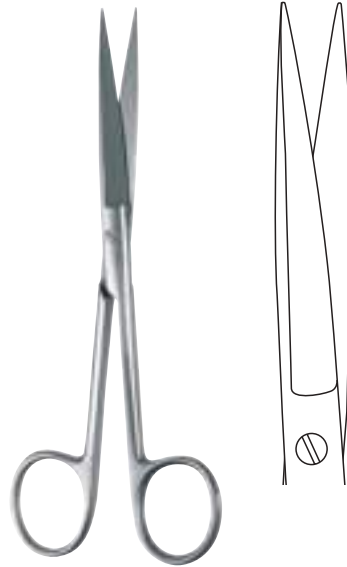

**03.04.84**  
14,5 cm – 5¾"

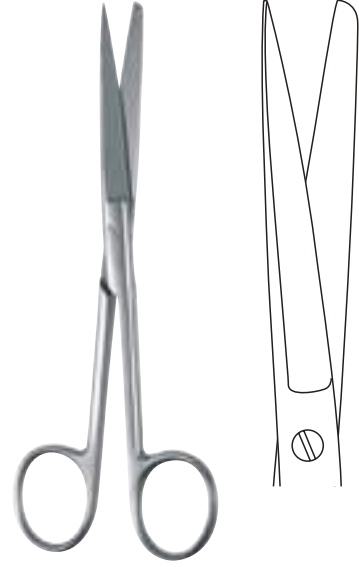

**03.06.84**  
14,5 cm – 5¾"



**03.03.84**  
14,5 cm – 5¾"



**03.05.84**  
14,5 cm – 5¾"



**03.07.84**  
14,5 cm – 5¾"



**Präparierscheren**  
**Dissecting Scissors**  
**Tijeras para preparación**  
**Ciseaux à préparation**  
**Forbici per preparazione**

1

12 cm – 4¾"



standard  
**02.40.12**

supercut  
**202.40.12**

black line  
**212.40.12**

"HM"  
**02.40.62**

supercut plus  
**202.40.62**

magic cut  
**222.40.62**

12 cm – 4¾"

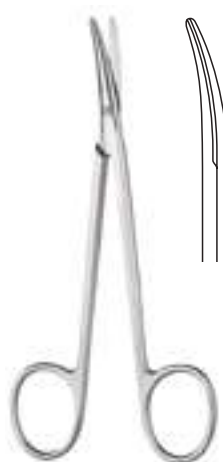

standard  
**02.41.12**

supercut  
**202.41.12**

black line  
**212.41.12**

"HM"  
**02.41.62**

supercut plus  
**202.41.62**

magic cut  
**222.41.62**



**04.13.12**  
 12 cm – 4¾"  
**Shea**

11,5 cm – 4½"



supercut  
**204.13.12**

black line  
**214.13.12**

supercut plus  
**204.13.62**

magic cut  
**224.13.62**

**Greenberg PAR**



**Ragnell (Kilner)**

13 cm – 5 1/8"

standard  
**04.13.13**

supercut  
**204.13.13**

black line  
**214.13.13**

"HM"  
**04.13.63**

supercut plus  
**204.13.63**

15 cm – 6"

standard  
**04.13.15**

supercut  
**204.13.15**

black line  
**214.13.15**

"HM"  
**04.13.65**

supercut plus  
**204.13.65**

1

18 cm – 7 1/8"

standard  
**04.13.18**

supercut  
**204.13.18**

black line  
**214.13.18**

"HM"  
**04.13.68**

supercut plus  
**204.13.68**

20 cm – 8"

standard  
**04.13.20**



**Präparierscheren**  
**Dissecting Scissors**  
**Tijeras para preparación**  
**Ciseaux à préparation**  
**Forbici per preparazione**

1



**"slim"**



14 cm – 5½"

- standard  
**04.24.14**
- supercut  
**204.24.14**
- "HM"  
**04.24.64**
- supercut plus  
**204.24.64**



**"slim"**



14 cm – 5½"

- standard  
**04.25.14**
- supercut  
**204.25.14**
- "HM"  
**04.25.64**
- supercut plus  
**204.25.64**



**Baby-Metzenbaum**



11,5 cm – 4½"

- standard  
**04.32.11**
- supercut  
**204.32.11**
- black line  
**214.32.11**
- "HM"  
**04.32.61**
- supercut plus  
**204.32.61**
- magic cut  
**224.32.61**



**Baby-Metzenbaum**



11,5 cm – 4½"

- standard  
**04.33.11**
- supercut  
**204.33.11**
- black line  
**214.33.11**
- "HM"  
**04.33.61**
- supercut plus  
**204.33.61**
- magic cut  
**224.33.61**



**Metzenbaum**



14 cm – 5½"

standard  
**04.32.14**

supercut  
**204.32.14**

black line  
**214.32.14**

"HM"  
**04.32.64**

supercut plus  
**204.32.64**

magic cut  
**224.32.64**



18 cm – 7¼"

standard  
**04.32.18**

supercut  
**204.32.18**

black line  
**214.32.18**

"HM"  
**04.32.68**

supercut plus  
**204.32.68**

magic cut  
**224.32.68**

1



20 cm – 8"

standard  
**04.32.20**

supercut  
**204.32.20**

black line  
**214.32.20**

"HM"  
**04.32.70**

supercut plus  
**204.32.70**

magic cut  
**224.32.70**



**Präparierscheren**  
**Dissecting Scissors**  
**Tijeras para preparación**  
**Ciseaux à préparation**  
**Forbici per preparazione**



**Metzenbaum**

1

14 cm – 5½"

standard  
**04.33.14**

supercut  
**204.33.14**

black line  
**214.33.14**

"HM"  
**04.33.64**

supercut plus  
**204.33.64**

magic cut  
**224.33.64**



15 cm – 6"

standard  
**04.33.15**

supercut  
**204.33.15**

black line  
**214.33.15**



18 cm – 7⅛"

standard  
**04.33.18**

supercut  
**204.33.18**

black line  
**214.33.18**

"HM"  
**04.33.68**

supercut plus  
**204.33.68**

magic cut  
**224.33.68**

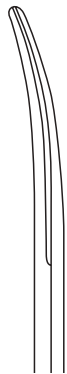

20 cm – 8"

standard  
**04.33.20**

supercut  
**204.33.20**

black line  
**214.33.20**

"HM"  
**04.33.70**

supercut plus  
**204.33.70**

magic cut  
**224.33.70**



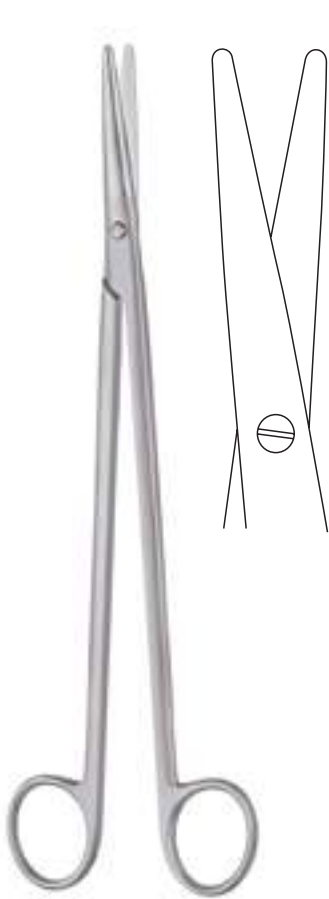

**Nelson**  
**(Metzenbaum)**

23 cm – 9"

- standard **04.32.23**
- supercut **204.32.23**
- black line **214.32.23**
- "HM" **04.32.73**
- supercut plus **204.32.73**
- magic cut **224.32.73**



26 cm – 10¼"

- standard **04.32.26**
- supercut **204.32.26**
- black line **214.32.26**

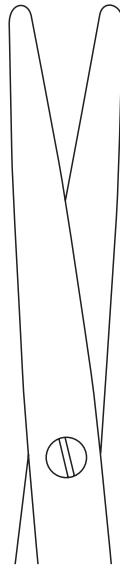

30 cm – 11¾"

- standard **04.32.30**
- supercut **204.32.30**
- black line **214.32.30**

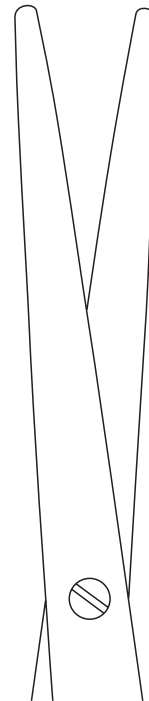





**Präparierscheren**  
**Dissecting Scissors**  
**Tijeras para preparación**  
**Ciseaux à préparation**  
**Forbici per preparazione**

1



**Nelson**  
**(Metzenbaum)**

23 cm – 9"

standard	04.33.23
supercut	204.33.23
black line	214.33.23
"HM"	04.33.73
supercut plus	204.33.73
magic cut	224.33.73

26 cm – 10<sup>1</sup>/<sub>4</sub>"

standard	04.33.26
supercut	204.33.26
black line	214.33.26
"HM"	04.33.76
supercut plus	204.33.76

30 cm – 11<sup>3</sup>/<sub>4</sub>"

standard	04.33.30
supercut	204.33.30
black line	214.33.30
"HM"	04.33.80
supercut plus	204.33.80
magic cut	224.33.80

**Präparierscheren**  
**Dissecting Scissors**  
**Tijeras para preparación**  
**Ciseaux à préparation**  
**Forbici per preparazione**



1



**Metzenbaum-slim**

14 cm – 5½"

standard	04.34.14
supercut	204.34.14
black line	214.34.14
"HM"	04.34.64
supercut plus	204.34.64

18 cm – 7½"

standard	04.34.18
supercut	204.34.18
black line	214.34.18
"HM"	04.34.68
supercut plus	204.34.68

20 cm – 8"

standard	04.34.20
supercut	204.34.20
black line	214.34.20
"HM"	04.34.70
supercut plus	204.34.70

23 cm – 9"

standard	04.34.23
supercut	204.34.23
black line	214.34.23
"HM"	04.34.73
supercut plus	204.34.73



**Präparierscheren**  
**Dissecting Scissors**  
**Tijeras para preparación**  
**Ciseaux à préparation**  
**Forbici per preparazione**

1



**Metzenbaum-slim**



14 cm – 5½"

standard  
**04.35.14**

supercut  
**204.35.14**

black line  
**214.35.14**

"HM"  
**04.35.64**

supercut plus  
**204.35.64**

magic cut  
**224.35.64**



18 cm – 7½"

standard  
**04.35.18**

supercut  
**204.35.18**

black line  
**214.35.18**

"HM"  
**04.35.68**

supercut plus  
**204.35.68**

magic cut  
**224.35.68**



20 cm – 8"

standard  
**04.35.20**

supercut  
**204.35.20**

black line  
**214.35.20**

"HM"  
**04.35.70**

supercut plus  
**204.35.70**

magic cut  
**224.35.70**



23 cm – 9"

standard  
**04.35.23**

supercut  
**204.35.23**

black line  
**214.35.23**

"HM"  
**04.35.73**

supercut plus  
**204.35.73**

magic cut  
**224.35.73**

**Präparierscheren**  
**Dissecting Scissors**  
**Tijeras para preparación**  
**Ciseaux à préparation**  
**Forbici per preparazione**



1

26 cm – 10¼"

28,5 cm – 11¼"

supercut  
**204.35.26**

supercut  
**204.35.28**



12 cm – 4¾"

14 cm – 5½"

standard  
**04.67.12**

standard  
**04.67.14**

supercut  
**204.67.12**

black line  
**214.67.12**



16 cm – 6¼"

18 cm – 7⅞"

standard  
**04.67.16**

standard  
**04.67.18**

supercut  
**204.67.16**

supercut  
**204.67.18**

black line  
**214.67.16**

black line  
**214.67.18**

magic cut  
**224.67.66**

magic cut  
**224.67.68**



**Metzenbaum-slim**



**Reynolds (Jameson)**



**Lungenscheren**  
**Lobectomy Scissors**  
**Tijeras pulmonares**  
**Ciseaux pulmonaires**  
**Forbici polmonari**

1



**54.40.27**  
28,5 cm – 11¼"  
**Willauer**



**54.40.30**  
30 cm – 11¾"  
**Craford**

**Lungenschere, Gewebeschere**  
**Lobectomy Scissors, Tissue Scissors**  
**Tijera pulmonar, Tijera para tejidos**  
**Ciseaux pulmonaires, Ciseaux à tissu**  
**Forbice polmonari, Forbice per tessuto**



1



**54.41.27**  
27 cm – 10<sup>3</sup>/<sub>4</sub>"  
**Finochietto**



**04.83.16**  
16 cm – 6<sup>1</sup>/<sub>4</sub>"  
**Locklin**

Gewebeschere  
Tissue scissors  
Tijera para tejidos  
Ciseaux à tissu  
Forbice per tessuto



**Gefäßscheren**  
**Vascular Scissors**  
**Tijeras vasculares**  
**Ciseaux vasculaires**  
**Forbici vascolari**

1



**02.50.52**  
11,5 cm – 4½”  
**Perwitschky**

geknöpft  
ball tip  
abotonada  
boutonnées  
bottonuta



**02.51.52**  
10 cm – 4”  
**Perwitschky**

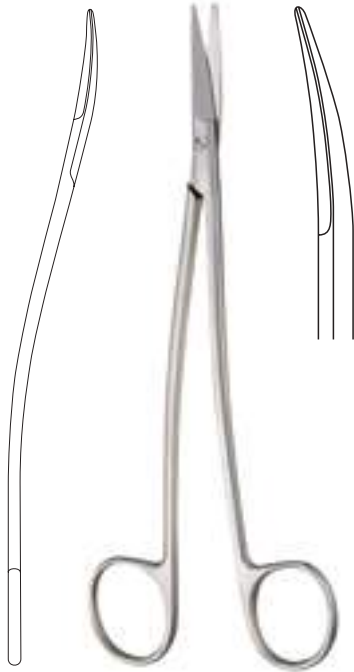

**04.65.18**  
18 cm – 7½”  
**Satinsky**

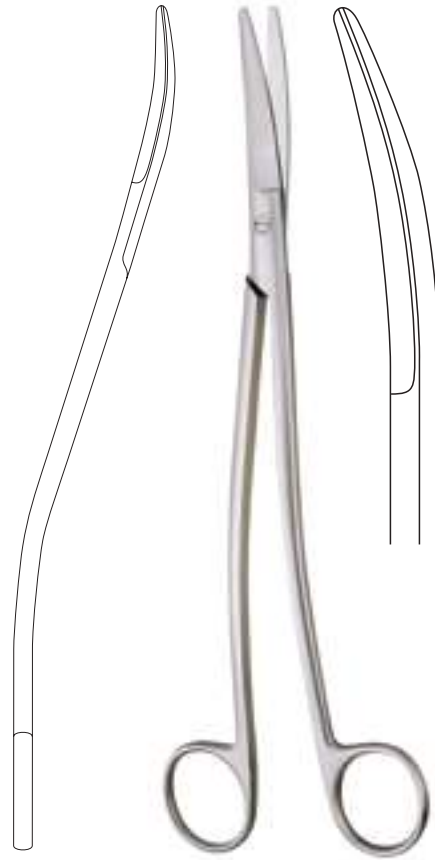

**04.65.23**  
23 cm – 9”  
**Klinkenbergh**

**Gefäßscheren  
Vascular Scissors  
Tijeras vasculares  
Ciseaux vasculaires  
Forbici vascolari**



1







**Gefäßscheren**  
**Vascular Scissors**  
**Tijeras vasculares**  
**Ciseaux vasculaires**  
**Forbici vascolari**

1

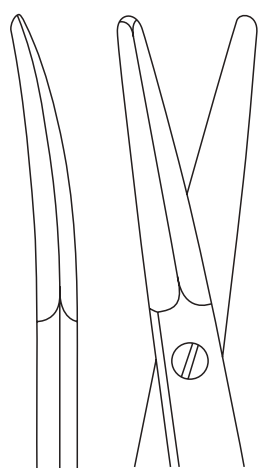

**55.13.18**  
18 cm – 7 1/8"

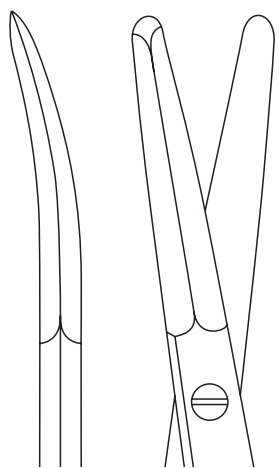

**55.13.19**  
19 cm – 7 1/2"

**Potts-Smith**

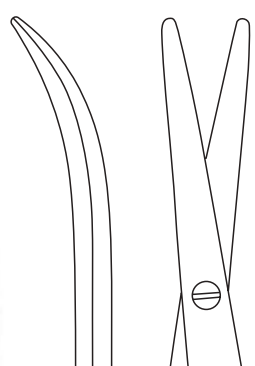
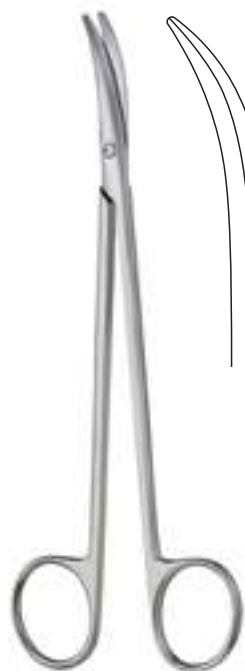

**55.13.75**  
18 cm – 7 1/8"  
**DeBakey**

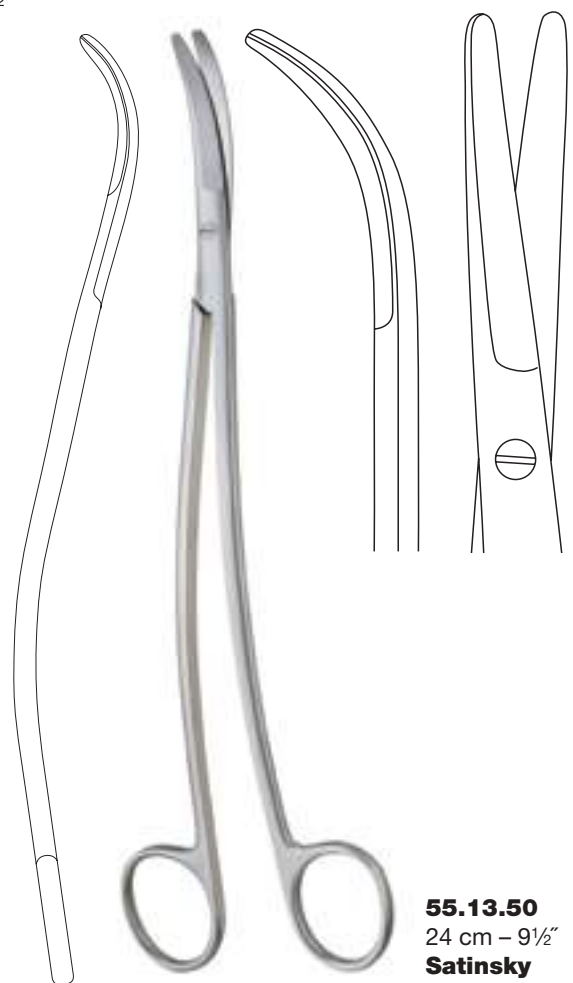

**55.13.50**  
24 cm – 9 1/2"  
**Satinsky**



1

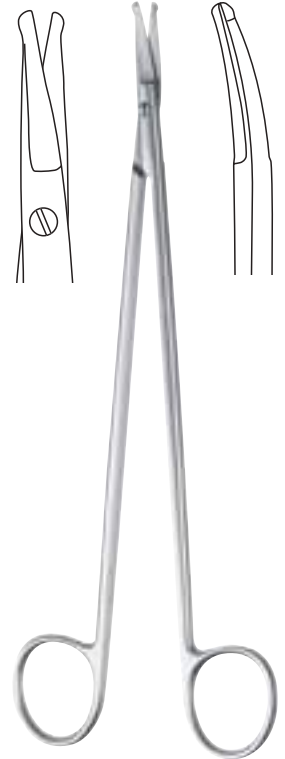
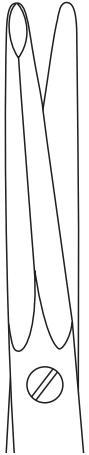

**57.25.20**  
 20 cm – 8"  
**Strully**



17 cm – 6¾"

supercut  
**204.73.17**

black line  
**214.73.17**

"HM"  
**04.73.67**

magic cut  
**224.73.67**



19 cm – 7½"

supercut  
**204.73.19**

black line  
**214.73.19**

"HM"  
**04.73.69**

magic cut  
**224.73.69**



23 cm – 9"

supercut  
**204.73.23**

black line  
**214.73.23**

"HM"  
**04.73.73**

magic cut  
**224.73.73**



**Gorney**



**Gefäßscheren**  
**Vascular Scissors**  
**Tijeras vasculares**  
**Ciseaux vasculaires**  
**Forbici vascolari**

1

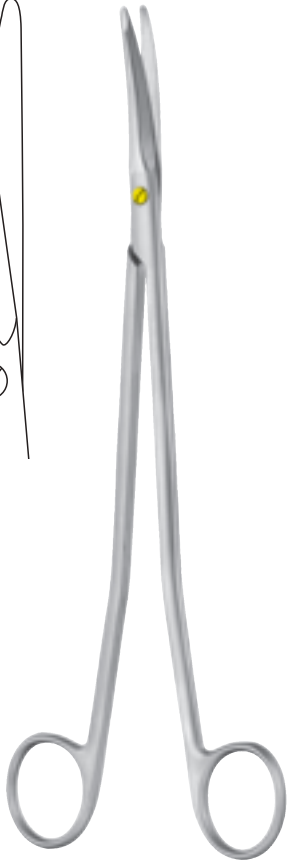
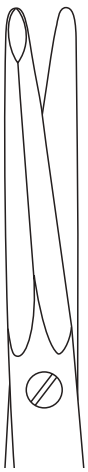

**Gorney-Freeman**



17 cm – 6<sup>3</sup>/<sub>4</sub>"

supercut  
**204.75.17**

black line  
**214.75.17**

"HM"  
**04.75.67**

magic cut  
**224.75.67**



19 cm – 7<sup>1</sup>/<sub>2</sub>"

supercut  
**204.75.19**

black line  
**214.75.19**

"HM"  
**04.75.69**

magic cut  
**224.75.69**



23 cm – 9"

supercut  
**204.75.23**

black line  
**214.75.23**

"HM"  
**04.75.73**

magic cut  
**224.75.73**

**Gefäßscheren**  
**Vascular Scissors**  
**Tijeras vasculares**  
**Ciseaux vasculaires**  
**Forbici vascolari**



1



**DeBakey**

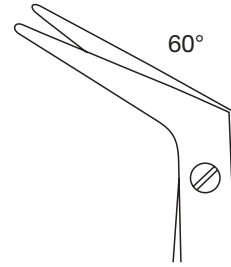
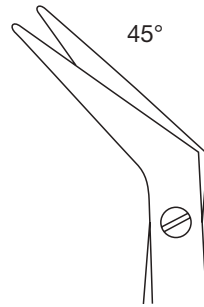

16 cm – 6¼"	<b>55.15.02</b>	<b>55.15.04</b>	<b>55.15.06</b>
23 cm – 9"	<b>55.15.12</b>	<b>55.15.14</b>	<b>55.15.16</b>
28 cm – 11"	<b>55.15.22</b>	<b>55.15.24</b>	<b>55.15.26</b>



**55.15.15**  
 23 cm – 9"  
**DeBakey "HM"**



**Gefäßscheren**  
**Vascular Scissors**  
**Tijeras vasculares**  
**Ciseaux vasculaires**  
**Forbici vascolari**

1



standard  
**55.15.42**

supercut  
**255.15.42**

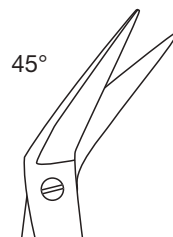

standard  
**55.15.44**

supercut  
**255.15.44**

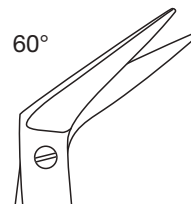

standard  
**55.15.46**

supercut  
**255.15.46**

19 cm – 7½"  
**Potts-Smith**

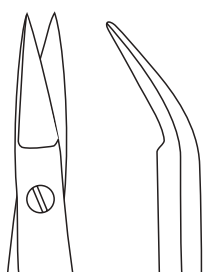

**55.15.50**

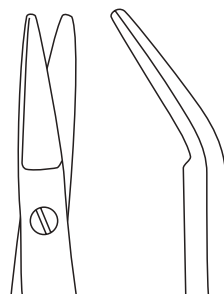

**55.15.51**

19 cm – 7½"  
**Potts-Smith**

**Gefäßscheren**  
**Vascular Scissors**  
**Tijeras vasculares**  
**Ciseaux vasculaires**  
**Forbici vascolari**



18 cm – 7 1/8"  
**Hegemann-Diethrich**

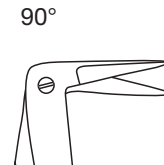
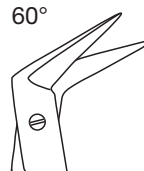
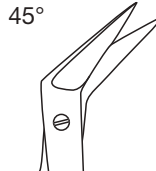

standard <b>55.15.32</b>	standard <b>55.15.34</b>	standard <b>55.15.36</b>	standard <b>55.15.39</b>	standard <b>55.15.40</b>
supercut <b>255.15.32</b>	supercut <b>255.15.34</b>	supercut <b>255.15.36</b>	supercut <b>255.15.39</b>	
magic cut <b>225.15.32</b>	magic cut <b>225.15.34</b>	magic cut <b>225.15.36</b>	magic cut <b>225.15.39</b>	



**55.15.41**  
 18 cm – 7 1/8"  
**Hegemann-Diethrich**



**Gefäßscheren**  
**Vascular Scissors**  
**Tijeras vasculares**  
**Ciseaux vasculaires**  
**Forbici vascolari**

1



**55.15.55**  
16 cm – 6¼"  
**DeBakey**



**55.15.63**  
13 cm – 5⅛"  
**Diethrich Gregory**



**55.15.58**  
16 cm – 6¼"  
**Favaloro**



**55.15.59**  
**Potts DeMartel**

**55.15.60**  
**Mills**

geknöpft  
ball tip  
abotonada  
boutonnées  
bottonuta

22,5 cm – 9"

**Mikro-Scheren**  
**Micro Scissors**  
**Tijeras micro**  
**Ciseaux micro**  
**Forbici micro**



1



18 cm – 7 1/8"

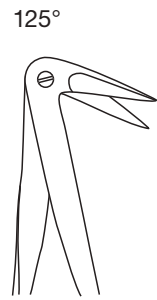
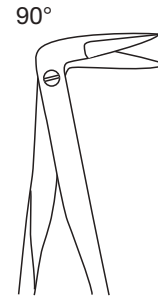
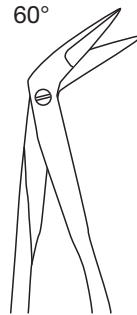
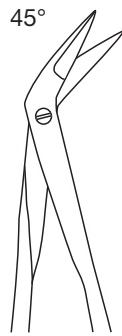

"HM"  
**05.19.25**

"HM"  
**05.19.45**

"HM"  
**05.19.60**

"HM"  
**05.19.90**

"HM"  
**05.19.95**

magic cut  
**225.19.25**

magic cut  
**225.19.45**

magic cut  
**225.19.60**

magic cut  
**225.19.90**

magic cut  
**225.19.95**



18 cm – 7 1/8"

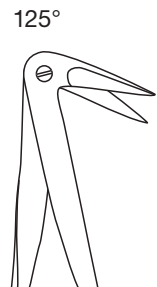
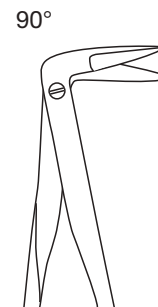
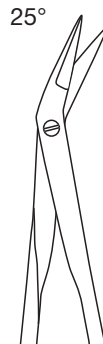

"HM"  
**05.21.25**

"HM"  
**05.21.45**

"HM"  
**05.21.60**

"HM"  
**05.21.90**

"HM"  
**05.21.95**





**Mikro-Scheren  
Micro Scissors  
Tijeras micro  
Ciseaux micro  
Forbici micro**

micro 2000

1



19,5 cm – 7¾"  
**Yasargil**



**58.19.20**



**58.19.21**



**58.19.25**



**58.19.26**

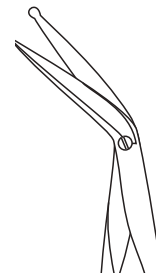

**58.19.27**

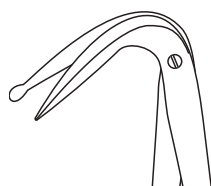

**58.19.28**  
Circumflex 124°

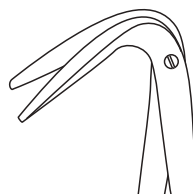

**58.19.29**  
Circumflex 124°



**58.19.30**



**58.19.31**



20 cm – 8"  
**micro 2000**



**58.20.70**



**58.20.71**



micro 2000



18 cm – 7 1/8"  
**Jacobson  
micro 2000**



**05.18.20**



**05.18.21**



**05.18.25**



**05.18.26**

1



**05.12.34**  
15 cm – 6"  
**Koshima**



Vannas Schneiden  
Vannas-type cutting edges  
Hojas según Vannas  
Lames selon Vannas  
Lame secondo Vannas



**05.12.32**  
15 cm – 6"  
**Koshima**



Mikroscheren für extrem kleine und  
feine Blutgefäße

Micro scissors for extremely small and  
fine blood vessels

Tijeras micro para vasos sanguíneos  
extremadamente pequeños y finos

Ciseaux micro pour des vaisseaux  
sanguins extrêmement petits et fins

Forbici chirurgiche per vasi sanguigni  
molto piccoli e fini



**Mikro-Scheren  
Micro Scissors  
Tijeras micro  
Ciseaux micro  
Forbici micro**

**micro 2000**



**micro 2000**

1



15 cm – 6"

standard  
**05.15.70**

18 cm – 7 1/8"

standard  
**05.18.70**

supercut  
**205.18.70**



standard  
**05.15.71**

standard  
**05.18.71**

supercut  
**205.18.71**



standard  
**05.15.72**

standard  
**05.18.72**

gezahnte Schneiden  
serrated cutting edges  
hojas dentadas  
lames dentelées  
lame dentellate



standard  
**05.15.73**

standard  
**05.18.73**

gezahnte Schneiden  
serrated cutting edges  
hojas dentadas  
lames dentelées  
lame dentellate



standard  
**05.15.81**

standard  
**05.18.81**



standard  
**05.15.83**

standard  
**05.18.83**

Leichtmetall-Instrumente  
mit blau eloxierten Rundgriffen

- | geringes Gewicht
- | gut ausbalanciert
- | sehr handlich
- | ermüdungsfreies Arbeiten
- | leicht zu pflegen
- | korrosionsbeständig

Light-weight instruments  
with blue-colored anodized round  
handles

- | extremely light weight
- | well balanced
- | easy to handle
- | fatigueless handling
- | easy to maintain
- | corrosion-resistant

Instrumentos de metal ligero  
con mangos redondos  
anodizados en azul

- | peso muy reducido
- | bien equilibrados
- | operar sin fatigarse
- | fácil manejo
- | fácil mantenimiento
- | resistente a la corrosión

Instruments en métal léger,  
avec manches ronds  
anodisés en bleu

- | poids réduit
- | bien équilibrés
- | très maniables
- | travail sans fatigue
- | entretien facile
- | résistants à la corrosion

Strumenti di metallo leggero  
con manici rotondi,  
anodizzati azzurri

- | peso minimo
- | equilibrio perfetto
- | maneggevoli
- | lavoro non affaticoso
- | manutenzione minima
- | resistenti alla corrosione



15 cm – 6"

Rundgriff 8 mm x  
 Round handle 8 mm x  
 Mango redondo 8 mm x  
 Manche rond 8 mm x  
 Manico rotondo x mm 8



standard  
**05.15.74**



standard  
**05.15.75**



standard  
**05.15.76**



standard  
**05.15.77**

supercut  
**205.15.74**

Vannas Schneiden  
 Vannas-type cutting edges  
 Hojas según Vannas  
 Lames selon Vannas  
 Lame secondo Vannas



**05.19.02**  
 23 cm – 9"



Mikro-Scheren, **TITAN**  
 Micro Scissors, **TITANIUM**  
 Tijeras micro, **TITANIO**  
 Ciseaux micro, **TITANE**  
 Forbici micro, **TITANIO**

Ti

1

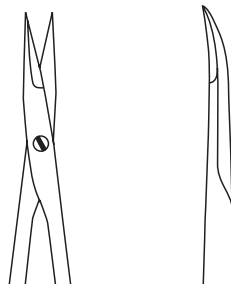

15 cm – 6"	<b>05.16.74</b>	<b>05.16.75</b>
18 cm – 7 <sup>1</sup> / <sub>8</sub> "	<b>05.18.74</b>	<b>05.18.75</b>
21 cm – 8 <sup>1</sup> / <sub>4</sub> "	<b>05.21.74</b>	<b>05.21.75</b>

Rundgriff x 8 mm  
 Round handle x 8 mm  
 Mango redondo x 8 mm  
 Manche rond x 8 mm  
 Manico rotondo x 8 mm

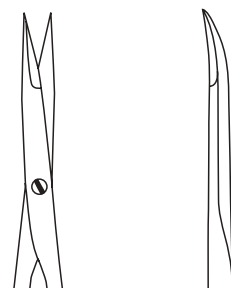

15 cm – 6"	<b>05.16.68</b>	<b>05.16.69</b>
18 cm – 7 <sup>1</sup> / <sub>8</sub> "	<b>05.18.68</b>	<b>05.18.69</b>
21 cm – 8 <sup>1</sup> / <sub>4</sub> "	<b>05.21.68</b>	<b>05.21.69</b>

**Mikro-Scheren**  
**Micro Scissors**  
**Tijeras micro**  
**Ciseaux micro**  
**Forbici micro**



16 cm – 6¼"

**05.18.92**



**05.18.93**



**05.18.94**



**05.18.95**



**05.18.96**



**05.18.97**



**Millesi**

Vannas Schneiden  
 Vannas-type cutting edges  
 Hojas según Vannas  
 Lames selon Vannas  
 Lame secondo Vannas

Gezahnte Schneiden  
 Serrated cutting edges  
 Hojas dentadas  
 Lames dentelées  
 Lame dentellate

1



18,5 cm – 7¼"

**05.18.98**  
**Yasargil**



**05.18.99**  
**Jacobson**



**05.19.01**  
**Potts-Yasargil**

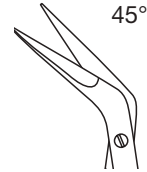

45°



**05.19.10**  
 18,5 cm – 7¼"



**05.18.90**  
 13 cm – 5½"  
**Biemer**



Venenschere  
 Vein scissors  
 Tijera para venas  
 Ciseaux pour veines  
 Forbice per vene



**Ligaturscheren**  
**Ligature Scissors**  
**Tijeras para ligaduras**  
**Ciseaux à ligature**  
**Forbici per legatura**

1



**“HM”**

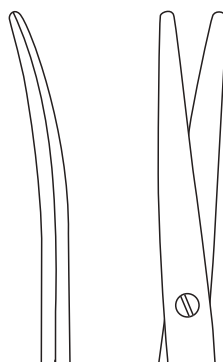

**14.06.84**  
14,5 cm – 5¾”



**14.06.88**  
18 cm – 7¼”

Ligaturscheren mit Mikro-Zahnung  
und Hartmetallschneiden

Ligature scissors with micro serration  
and tungsten carbide edges

Tijeras para ligaduras con dentado micro  
y de carburo tungsteno

Ciseaux à ligature avec denture micro  
et lames en tungstène

Forbici per legatura con micro dentatura  
e lame in carburo tungsteno



**14.06.93**  
23 cm – 9”

medicon

Pinzetten  
Forceps  
Pinzas  
Pinces  
Pinze





**Anatomische Pinzetten**  
**Dressing Forceps**  
**Pinzas anatómicas**  
**Pinces anatomiques**  
**Pinze anatomiche**

2



**06.00.64**  
 14,5 cm – 5¾"

**06.00.68**  
 18 cm – 7¼"



**06.00.70**  
 20 cm – 8"

**06.00.75**  
 25 cm – 10"



**06.02.65** 15 cm – 6"  
**06.02.68** 18 cm – 7¼"  
**06.02.70** 20 cm – 8"  
**06.02.73** 23 cm – 9"  
**06.02.75** 25 cm – 10"

**Potts-Smith "HM"**

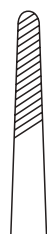

**06.04.33**  
 13 cm – 5¼"



**06.04.34**  
 14,5 cm – 5¾"



**06.04.36**  
 16 cm – 6¼"

**Blank**

**Feine Pinzetten, anatomisch/chirurgisch**  
**Delicate Forceps, Dressing/Tissue**  
**Pinzas finas, anatómicas/quirúrgicas**  
**Pinces fines, anatómicas/chirurgicales**  
**Pinze delicate, anatomiche/chirurgiche**



2



**06.20.65**  
 15 cm – 6"  
**Adson "HM"**



**06.21.65**  
 15 cm – 6"  
**Adson "HM"**



**06.22.15**  
 15 cm – 6"  
**Micro-Adson**



**06.23.15**  
 15 cm – 6"  
**Micro-Adson**



12 cm – 4¾"  
**Adson-Brown**

**06.25.12**

7 x 7 Zähne  
 7 x 7 teeth  
 7 x 7 dientes  
 7 x 7 dents  
 7 x 7 denti



**06.25.15**

9 x 9 Zähne  
 9 x 9 teeth  
 9 x 9 dientes  
 9 x 9 dents  
 9 x 9 denti



**06.25.72**  
 12 cm – 4¾"  
**Adson-Brown**

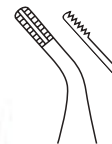

**06.25.82**  
 12 cm – 4¾"  
**Adson-Graefe**





**Pinzetten, anatomisch/chirurgisch**  
**Forceps, Dressing/Tissue**  
**Pinzas, anatómicas/quirúrgicas**  
**Pinces, anatómicas/quirúrgicas**  
**Pinze, anatomiche/chirurgiche**

2



**Semken**



**06.31.12**  
12,5 cm – 5"



**06.31.15**  
15 cm – 6"



**06.31.22**  
12,5 cm – 5"



**06.31.25**  
15 cm – 6"



**06.31.32**  
12,5 cm – 5"  
**Semken**



**"Select"**



**06.34.51**  
11 cm – 4 3/8"



**06.34.53**  
13 cm – 5 1/8"



**06.34.55**  
15 cm – 6"



**06.34.58**  
18 cm – 7 1/8"



**06.34.60**  
20 cm – 8"

sehr fein  
delicate  
muy fina  
très fin  
molto fine



**06.35.51**  
11 cm – 4 3/8"



**06.35.53**  
13 cm – 5 1/8"



**06.35.55**  
15 cm – 6"



**06.35.58**  
18 cm – 7 1/8"



**06.35.60**  
20 cm – 8"

**Pinzette, anatomisch/chirurgisch**  
**Forceps, Dressing/Tissue**  
**Pinzas, anatómicas/quirúrgicas**  
**Pinces, anatómicas/quirúrgicas**  
**Pinze, anatomiche/chirurgiche**

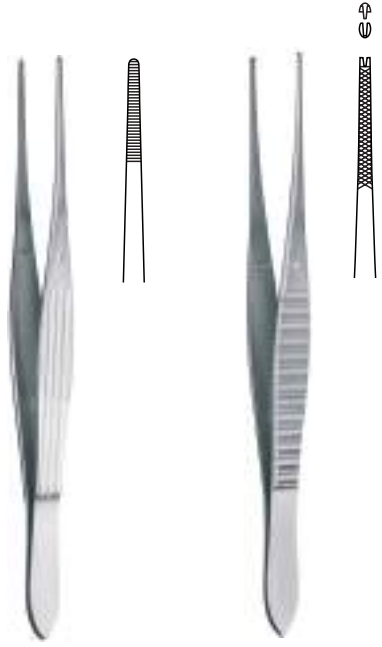

**06.40.15**  
15 cm – 6"  
**McIndoe**

**06.40.85**  
15 cm – 6"  
**Gillies**

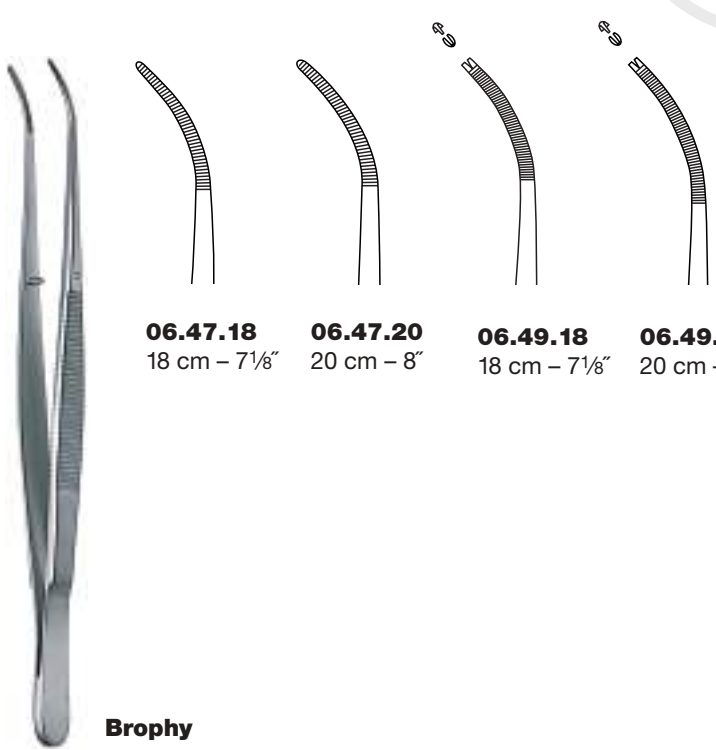

**Brophy**

**06.47.18**  
18 cm – 7 1/8"

**06.47.20**  
20 cm – 8"

**06.49.18**  
18 cm – 7 1/8"

**06.49.20**  
20 cm – 8"



**Potts-Smith**

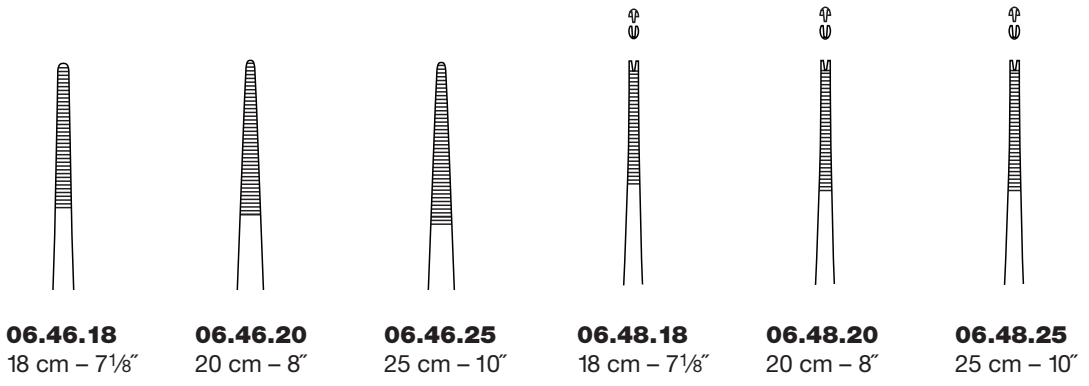

**06.46.18**  
18 cm – 7 1/8"

**06.46.20**  
20 cm – 8"

**06.46.25**  
25 cm – 10"

**06.48.18**  
18 cm – 7 1/8"

**06.48.20**  
20 cm – 8"

**06.48.25**  
25 cm – 10"



**Pinzetas, anatómico/cirúrgico**  
**Forceps, Dressing/Tissue**  
**Pinzas, anatómicas/quirúrgicas**  
**Pinces, anatómicos/cirúrgicos**  
**Pinze, anatómiche/cirúrgiche**

2



**06.45.20**  
20 cm – 8"



**06.45.90**  
20 cm – 8"



**06.60.17**



**06.60.87**

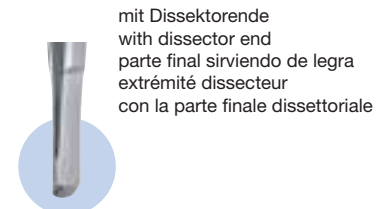

mit Dissektorende  
with dissector end  
parte final sirviendo de legra  
extrémité dissecteur  
con la parte finale dissettoriale

18 cm – 7 1/8"  
**Cushing**



**06.60.68**



**06.60.69**

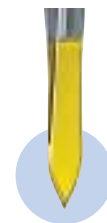

mit Dissektorende  
with dissector end  
parte final sirviendo de legra  
extrémité dissecteur  
con la parte finale dissettoriale

18 cm – 7 1/8"  
**Cushing "HM"**

**Atraumatische Pinzetten**  
**Atraumatic Forceps**  
**Pinzas atraumáticas**  
**Pinces atraumatiques**  
**Pinze atraumatiche**



2

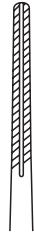

**06.56.15**  
15 cm – 6"



**06.56.24**  
24 cm – 9½"

**“AT”**



**06.58.15**  
15 cm – 6"



**06.58.24**  
24 cm – 9½"



**“AT”**



**Atraumatische Pinzetten**  
**Atraumatic Forceps**  
**Pinzas atraumáticas**  
**Pinces atraumatiques**  
**Pinze atraumatiche**

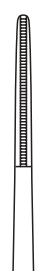
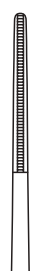
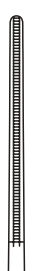

“AT” =  
  
 atraumatische Riefung  
 atraumatic serration  
 estrías atraumáticas  
 striure atraumatique  
 striatura atraumatica

2

	1,5 mm	1,5 mm	1,5 mm	1,5 mm
				
	<b>06.50.15</b> 15 cm – 6"	<b>06.50.19</b> 20 cm – 8"	<b>06.50.24</b> 24 cm – 9½"	<b>06.50.30</b> 30 cm – 11¼"

Gefäßpinzetten  
 Vascular forceps  
 Pinzas vasculares  
 Pinces vasculaires  
 Pinze vascolari

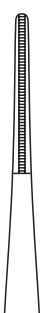
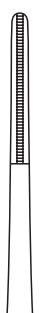
**DeBakey “AT”**

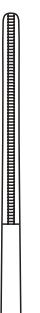
	2 mm	2 mm	2 mm	2 mm
				
	<b>06.52.15</b> 15 cm – 6"	<b>06.52.19</b> 20 cm – 8"	<b>06.52.24</b> 24 cm – 9½"	<b>06.52.30</b> 30 cm – 11¼"

**DeBakey “AT”**



**Atraumatische Pinzetten**  
**Atraumatic Forceps**  
**Pinzas atraumáticas**  
**Pinces atraumatiques**  
**Pinze atraumatiche**

“AT” =  
 atraumatische Riefung  
 atraumatic serration  
 estriás atraumáticas  
 striure atraumatique  
 striatura atraumatica

2

	2,8 mm	2,8 mm	2,8 mm	2,8 mm
	<b>06.54.15</b>	<b>06.54.19</b>	<b>06.54.24</b>	<b>06.54.30</b>
	15 cm – 6"	20 cm – 8"	24 cm – 9½"	30 cm – 11¼"
	Gefäßpinzetten Vascular forceps Pinzas vasculares Pinces vasculaires Pinze vascolari			

**DeBakey “AT”**

	3,5 mm	3,5 mm	3,5 mm	3,5 mm
	<b>06.55.15</b>	<b>06.55.19</b>	<b>06.55.24</b>	<b>06.55.30</b>
	15 cm – 6"	20 cm – 8"	24 cm – 9½"	30 cm – 11¼"
	Gefäßpinzetten Vascular forceps Pinzas vasculares Pinces vasculaires Pinze vascolari			

**DeBakey “AT”**





**Atraumatische Pinzetten**  
**Atraumatic Forceps**  
**Pinzas atraumáticas**  
**Pinces atraumatiques**  
**Pinze atraumatiche**

“AT” =  
  
 atraumatische Riefung  
 atraumatic serration  
 estrías atraumáticas  
 striure atraumatique  
 striatura atraumatica

2



**DeBakey “AT”**

1,5 mm

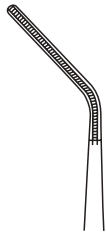

**06.57.15**  
15 cm – 6”

1,5 mm



**06.57.19**  
20 cm – 8”

1,5 mm

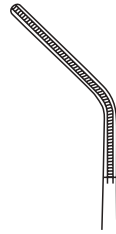

**06.57.24**  
24 cm – 9½”

1,5 mm

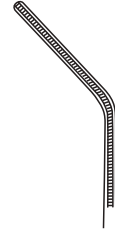

**06.57.30**  
30 cm – 11¼”

Gefäßpinzetten  
 Vascular forceps  
 Pinzas vasculares  
 Pinces vasculaires  
 Pinze vascolari



**DeBakey “AT”**

2 mm



**06.59.15**  
15 cm – 6”

2 mm



**06.59.19**  
20 cm – 8”

2 mm



**06.59.24**  
24 cm – 9½”

2 mm



**06.59.30**  
30 cm – 11¼”

“AT” =  
 atraumatische Riefung  
 atraumatic serration  
 estriás atraumáticas  
 striure atraumatique  
 striatura atraumatica



**Atraumatische Pinzetten**  
**Atraumatic Forceps**  
**Pinzas atraumáticas**  
**Pinces atraumatiques**  
**Pinze atraumatiche**



2



**DeBakey “AT”**

2,4 mm

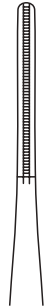

**06.62.15**  
 15 cm – 6”

2,4 mm

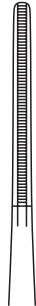

**06.62.19**  
 20 cm – 8”

2,4 mm



**06.62.24**  
 24 cm – 9½”

2,4 mm

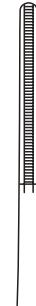

**06.62.30**  
 30 cm – 11¼”

Gefäßpinzetten  
 Vascular forceps  
 Pinzas vasculares  
 Pinces vasculaires  
 Pinze vascolari

2,8 mm



**DeBakey “AT”**



**06.64.15**  
 15 cm – 6”

2,8 mm



**06.64.19**  
 20 cm – 8”

2,8 mm



**06.64.24**  
 24 cm – 9½”

2,8 mm



**06.64.30**  
 30 cm – 11¼”





**Atraumatische Pinzetten**  
**Atraumatic Forceps**  
**Pinzas atraumáticas**  
**Pinces atraumatiques**  
**Pinze atraumatiche**

“AT” =  
 atraumatische Riefung  
 atraumatic serration  
 estrías atraumáticas  
 striure atraumatique  
 striatura atraumatica

2

3,5 mm      3,5 mm      3,5 mm      3,5 mm

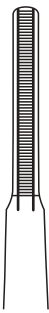
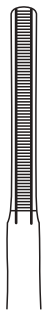
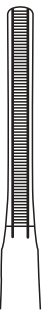
**06.66.15** 15 cm – 6”  
**06.66.19** 20 cm – 8”  
**06.66.24** 24 cm – 9½”  
**06.66.30** 30 cm – 11¾”

**DeBakey “AT”**

Gefäßpinzetten  
 Vascular forceps  
 Pinzas vasculares  
 Pinces vasculaires  
 Pinze vascolari

1,5 mm



**06.89.15** 15 cm – 6”  
**06.89.18** 18 cm – 7”  
**06.89.21** 21 cm – 8¼”

1,5 mm







**DeBakey “AT”**

mit Gewicht  
 with weight  
 con peso  
 avec poids  
 con peso

**06.89.25** 15 cm – 6”  
**06.89.28** 18 cm – 7”  
**06.89.31** 21 cm – 8¼”

1,2 mm      1,5 mm      1,5 mm      1,5 mm

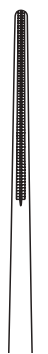
**06.51.15** 15 cm – 6”  
**06.51.20** 20 cm – 8”  
**06.51.24** 24 cm – 9½”  
**06.51.30** 30 cm – 11¾”

**DeBakey “AT”**

extrem leicht  
 extremely light  
 especialmente ligera  
 extrêmement légère  
 estremamente leggera

“AT” =  
 atraumatische Riefung  
 atraumatic serration  
 estriás atraumáticas  
 striure atraumatique  
 striatura atraumatica



Atraumatische Pinzetten, **TITAN**  
 Atraumatic Forceps, **TITANIUM**  
 Pinzas atraumáticas, **TITANIO**  
 Pincas atraumatiques, **TITANE**  
 Pinze atraumatiche, **TITANIO**

Ti



2

1,0 mm

1,0 mm

1,0 mm

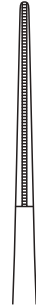

**06.70.15**  
 15 cm – 6"

**06.70.20**  
 20 cm – 8"

**06.70.24**  
 24 cm – 9½"

Gefäßpinzetten  
 Vascular forceps  
 Pinzas vasculares  
 Pincas vasculaires  
 Pinze vascolari

**DeBakey "AT"**

1,5 mm

1,5 mm

1,5 mm

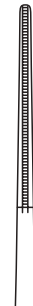
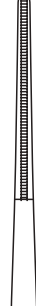

**06.72.15**  
 15 cm – 6"

**06.72.20**  
 20 cm – 8"

**06.72.24**  
 24 cm – 9½"

**DeBakey "AT"**



Atraumatische Pinzetten, **TITAN**  
 Atraumatic Forceps, **TITANIUM**  
 Pinzas atraumáticas, **TITANIO**  
 Pincas atraumáticas, **TITANE**  
 Pinze atraumatiche, **TITANIO**

Ti

“AT” =  
 atraumatische Riefung  
 atraumatic serration  
 estrías atraumáticas  
 striure atraumatique  
 striatura atraumatica

2

2,0 mm



**06.74.15**  
 15 cm – 6"

2,0 mm

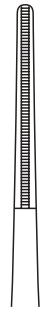

**06.74.20**  
 20 cm – 8"

2,0 mm

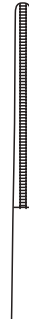

**06.74.24**  
 24 cm – 9½"

Gefäßpinzetten  
 Vascular forceps  
 Pinzas vasculares  
 Pincas vasculaires  
 Pinze vascolari

**DeBakey "AT"**

2,8 mm

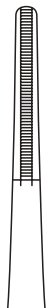

**06.76.15**  
 15 cm – 6"

2,8 mm

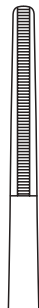

**06.76.20**  
 20 cm – 8"

2,8 mm

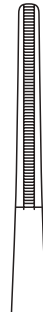

**06.76.24**  
 24 cm – 9½"

**DeBakey "AT"**



Atraumatische Pinzetten, **TITAN**  
 Atraumatic Forceps, **TITANIUM**  
 Pinzas atraumáticas, **TITANIO**  
 Pincas atraumatiques, **TITANE**  
 Pinze atraumatiche, **TITANIO**

“AT” =  
 atraumatische Riefung  
 atraumatic serration  
 estriás atraumáticas  
 striure atraumatique  
 striatura atraumatica

Ti

2

1,2 mm

1,2 mm

1,2 mm

1,2 mm

1,2 mm

1,2 mm



**06.90.15**  
15 cm – 6”

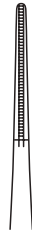

**06.90.18**  
18 cm – 7 1/8”



**06.90.21**  
21 cm – 8 1/4”



**06.91.15**  
15 cm – 6”



**06.91.18**  
18 cm – 7 1/8”



**06.91.21**  
21 cm – 8 1/4”

Gefäßpinzetten  
 Vascular forceps  
 Pinzas vasculares  
 Pincas vasculaires  
 Pinze vascolari

DeBakey “AT”

1,8 mm

1,8 mm

1,8 mm

1,8 mm

1,8 mm

1,8 mm



**06.92.15**  
15 cm – 6”



**06.92.18**  
18 cm – 7 1/8”



**06.92.21**  
21 cm – 8 1/4”

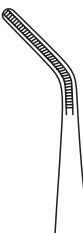

**06.93.15**  
15 cm – 6”



**06.93.18**  
18 cm – 7 1/8”



**06.93.21**  
21 cm – 8 1/4”

DeBakey “AT”



**Gewebefasspinzetten**  
**Tissue Grasping Forceps**  
**Pinzas para agarrar tejidos**  
**Pinces pour saisir le tissu**  
**Pinze per afferrare tessuti**

2



14,5 cm – 5 3/4"  
**Duval**

8 mm



**06.88.07**  
 # 1

10 mm



**06.88.10**  
 # 2



20 cm – 8"  
**Collin-Duval**

14 mm

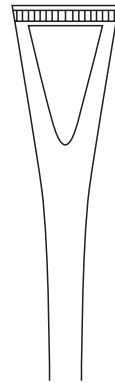

**06.88.14**  
 # 1

18 mm

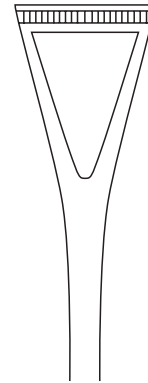

**06.88.18**  
 # 2

27 mm

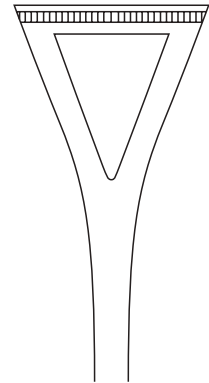

**06.88.27**  
 # 3



**07.17.18** 18 cm – 7 1/8"  
**07.17.23** 23 cm – 9"  
**Tuttle**



**07.19.15** 15 cm – 6"  
**07.19.23** 23 cm – 9"  
**Nelson**



**Gewebefasspinzetten**  
**Tissue Grasping Forceps**  
**Pinzas para agarrar tejidos**  
**Pinces pour saisir le tissu**  
**Pinze per afferrare tessuti**



2



**Brown**

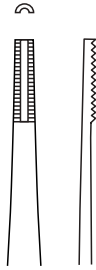

**07.10.15**  
15 cm – 6"

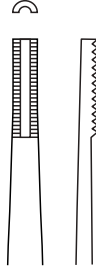

**07.10.20**  
20 cm – 8"

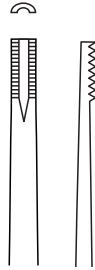

**07.10.25**  
25 cm – 10"



**07.15.93**  
23 cm – 9"  
**Mayo**



**07.16.15** 15 cm – 6"  
**07.16.23** 23 cm – 9"  
**Wangensteen**



**07.16.65** 15 cm – 6"  
**07.16.73** 23 cm – 9"  
**07.16.74** 25 cm – 10"  
**Wangensteen "HM"**





Mikro Pinzetten, **TITAN**  
 Micro Forceps, **TITANIUM**  
 Micro Pinzas, **TITANIO**  
 Micro Pincers, **TITANE**  
 Micro Pinze, **TITANIO**

**Ti**

2



0,4 mm



0,4 mm



0,8 mm



0,8 mm



15 cm – 6"	<b>07.74.15</b>	<b>07.75.15</b>	<b>07.76.15</b>	<b>07.77.15</b>
18 cm – 7 1/8"	<b>07.74.18</b>	<b>07.75.18</b>	<b>07.76.18</b>	<b>07.77.18</b>
21 cm – 8 1/4"	<b>07.74.21</b>	<b>07.75.21</b>	<b>07.76.21</b>	<b>07.77.21</b>



x 1 mm



x 2 mm



x 1 mm



x 2 mm



15 cm – 6"	<b>59.45.15</b>	<b>59.46.15</b>	<b>59.47.15</b>	<b>59.48.15</b>
18 cm – 7 1/8"	<b>59.45.18</b>	<b>59.46.18</b>	<b>59.47.18</b>	<b>59.48.18</b>
21 cm – 8 1/4"	<b>59.45.21</b>	<b>59.46.21</b>	<b>59.47.21</b>	<b>59.48.21</b>

Ringe gerieft  
 Tips serrated  
 Anillos estriados  
 Anneaux striés  
 Anelli striati

Ringe diamantbeschichtet  
 Tips diamond dust coated  
 Anillos diamantados  
 Anneaux à couche diamantée  
 Anelli diamantati



0,3 mm



spitz  
 sharp  
 aguda  
 pointue  
 acuta

**07.66.15**  
 15 cm – 6"  
**Jacobson-Adson**

x 1,0 u 0,5 mm



3:1

**59.49.15**  
 15 cm – 6"

**59.49.18**  
 18 cm – 7"

**59.49.21**  
 21 cm – 8¼"

x 0,8 u 0,4 mm



3:1

**59.49.25**  
 15 cm – 6"

**59.49.28**  
 18 cm – 7"

**59.49.31**  
 21 cm – 8¼"

mit Gewicht  
 with weight  
 con peso  
 avec poids  
 con peso

0,4 mm

0,4 mm

0,5 mm



**07.70.11**  
 11 cm – 4¾"

**07.70.15**  
 15 cm – 6"

**07.70.18**  
 18 cm – 7½"

spitz  
 sharp  
 aguda  
 pointue  
 acuta

**Jacobson**



**Mikro Pinzetten**  
**Micro Forceps**  
**Micro Pinzas**  
**Micro Pincers**  
**Micro Pinze**

2

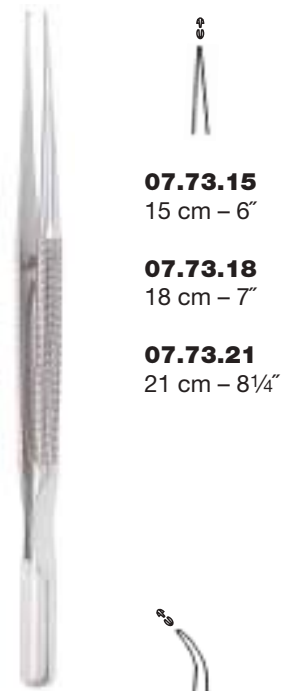
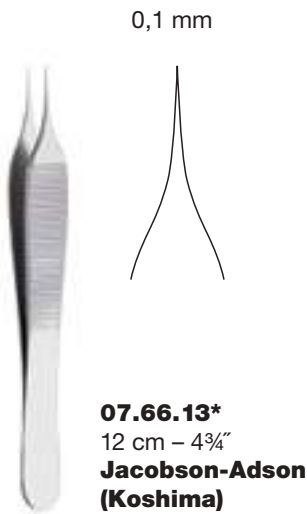
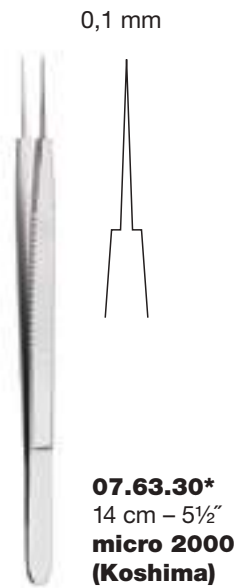
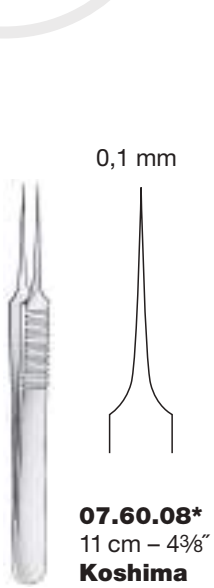

\* = Ultra fein  
 Ultra fine  
 Ultra fina  
 Ultra delicate  
 Molto delicata

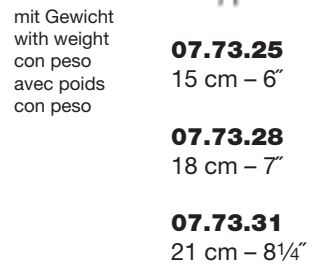
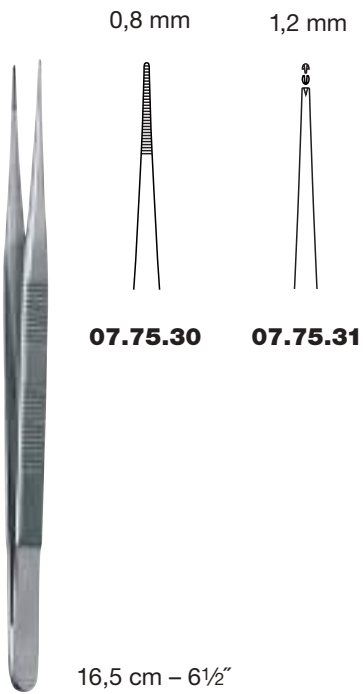



**micro 2000**

0,2 mm



**07.63.31**  
 14 cm – 5½"  
**micro 2000**

0,3 mm



**07.63.32**  
 14 cm – 5½"  
**micro 2000**

0,5 mm



**13.70.72**  
 14 cm – 5½"  
**micro 2000**

0,8 mm

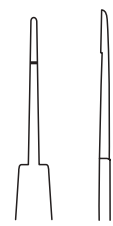

**13.70.74**

Nahtpinzetten  
 Suture forceps  
 Pinzas para sutura  
 Pincers à suture  
 Pinze per sutura

2

0,4 mm



**07.72.19**  
 19,5 cm – 7¾"  
**micro 2000**

1,0 mm



**07.72.40**  
 19,5 cm – 7¾"  
**micro 2000**



**Mikro Pinzetten**  
**Micro Forceps**  
**Micro Pinzas**  
**Micro Pincés**  
**Micro Pinze**

**micro 2000**

2



15 cm – 6"  
**micro 2000**

0,2 mm



**07.64.63**

spitz  
 sharp  
 aguda  
 pointue  
 acuta

0,3 mm



**07.64.64**

stumpf  
 blunt  
 roma  
 mousse  
 smussa

0,2 mm



**07.64.73**

spitz  
 sharp  
 aguda  
 pointue  
 acuta

0,3 mm



**07.64.74**

stumpf  
 blunt  
 roma  
 mousse  
 smussa

Leichtmetall-Instrumente mit  
 blau eloxierten Rundgriffen  
 | geringes Gewicht  
 | gut ausbalanciert  
 | sehr handlich  
 | ermüdungsfreies Arbeiten  
 | leicht zu pflegen  
 | korrosionsbeständig

Light-weight instruments with  
 blue-colored anodized  
 round handles  
 | extremely light weight  
 | well balanced  
 | easy to handle  
 | fatigueless working  
 | easy to maintain  
 | corrosion-resistant

Instrumentos de metal ligero  
 con mangos redondos  
 anodizados en azul  
 | peso muy reducido  
 | bien equilibrados  
 | operar sin fatigarse  
 | fácil manejo  
 | fácil mantenimiento  
 | resistente a la corrosión

Instruments en métal léger,  
 avec manches ronds  
 anodisés en bleu  
 | poids réduit  
 | bien équilibrés  
 | très maniables  
 | travail sans fatigue  
 | entretien facile  
 | résistants à la corrosion

Strumenti di metallo leggero  
 con manici rotondi,  
 anodizzati azzurri  
 | peso minimo  
 | equilibrio perfetto  
 | maneggevoli  
 | lavoro non affaticoso  
 | manutenzione minima  
 | resistenti alla corrosione



18 cm - 7 1/8"  
**micro 2000**

0,3 mm



**07.64.83**

spitz  
 sharp  
 aguda  
 pointue  
 acuta

0,4 mm



**07.64.84**

stumpf  
 blunt  
 roma  
 mousse  
 smussa

0,3 mm



**07.64.93**

spitz  
 sharp  
 aguda  
 pointue  
 acuta

0,4 mm



**07.64.94**

stumpf  
 blunt  
 roma  
 mousse  
 smussa



**micro 2000**

0,3 mm

0,3 mm

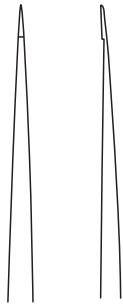

**13.71.42**



**13.71.43**

15 cm – 6"  
**micro 2000**

Nahtpinzetten  
 Suture forceps  
 Pinzas para sutura  
 Pincers à suture  
 Pinze per sutura

0,6 mm

0,6 mm

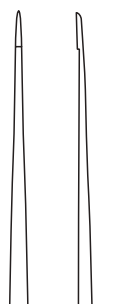

**13.71.82**



**13.71.83**

18 cm – 7 1/8"  
**micro 2000**

0,3 mm

0,5 mm

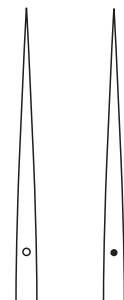

**58.20.60**

spitz  
 sharp  
 aguda  
 pointue  
 acuta

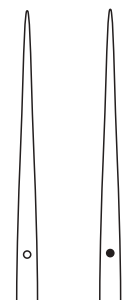

**58.20.64**

stumpf  
 blunt  
 roma  
 mousse  
 smussa

20 cm – 8"  
**micro 2000**



**Mikro-Knüpfpinzetten**  
**Micro Suture Tying Forceps**  
**Micro Pinza para enlazar**  
**Micro-Pinces pour nouer les fils**  
**Micro-Pinze per annodare fili**

2

0,3 mm

0,3 mm

0,3 mm

0,3 mm



12 cm – 4¾"

**13.71.50**

**13.71.51**

**13.71.52**

**13.71.53**

15 cm – 6"

**13.71.60**

**13.71.61**

**13.71.62**

**13.71.63**

18 cm – 7⅛"

**13.71.70**

**13.71.71**

**13.71.72**

**13.71.73**

1x2 Zähne  
 1x2 teeth  
 1x2 dientes  
 1x2 dents  
 1x2 denti

0,6 mm



**13.71.84**  
 23 cm – 9"

0,8 mm



**13.71.86**  
 18 cm – 7⅛"  
**Austin**



**13.71.05**  
 15 cm – 6"

**13.71.08**  
 18 cm – 7"

**13.71.11**  
 21 cm – 8¼"



**13.71.15**  
 15 cm – 6"

**13.71.18**  
 18 cm – 7"

**13.71.21**  
 21 cm – 8¼"

mit Gewicht  
 with weight  
 con peso  
 avec poids  
 con peso

medicon

**Sauginstrumente**  
**Suction Instruments**  
**Instrumentos de aspiración**  
**Instruments à aspiration**  
**Strumenti d'aspirazione**





**Sauginstrumente**  
**Suction Instruments**  
**Instrumentos de aspiración**  
**Instrumenti à aspiration**  
**Strumenti d'aspirazione**

3



**09.85.12**

Saugkopf allein  
Suction tip only  
Cabeza aspiradora suelta  
Tête aspiratrice seule  
Testa aspiratrice sola

**09.85.00**  
28 cm – 11"  
**Yankauer**



**09.85.01**  
31 cm – 12¼"  
**Yankauer**



**09.85.15**

Saugkopf allein  
Suction tip only  
Cabeza aspiradora suelta  
Tête aspiratrice seule  
Testa aspiratrice sola



**09.85.17**

Saugkopf allein  
Suction tip only  
Cabeza aspiradora suelta  
Tête aspiratrice seule  
Testa aspiratrice sola



mit Absperrventil  
with thumb control valve  
con válvula de cierre  
avec valve d'arrêt  
con valvola d'arresto

**09.85.05**  
29 cm – 11 $\frac{3}{8}$ "  
**Yankauer**



**09.85.07**  
28 cm – 11"  
**DeBakey**



**09.85.08**  
24 cm – 9 $\frac{1}{2}$ "  
**Andrews-Pynchon**



**Sauginstrumente**  
**Suction Instruments**  
**Instrumentos de aspiración**  
**Instrumenti à aspiration**  
**Strumenti d'aspirazione**

x 8 mm



**09.86.10**  
36 cm – 14 $\frac{1}{8}$ "  
**Cooley**

x 8 mm



**09.86.15**  
30 cm – 11 $\frac{3}{4}$ "  
**Cooley**

x 9 mm



**09.86.16**  
30 cm – 11 $\frac{3}{4}$ "  
**Cooley**

Ø 8 mm



**09.86.20**  
32 cm – 12 $\frac{1}{2}$ "  
**Cooley**

13 cm – 5 $\frac{1}{8}$ "

x 9 mm



**09.86.25**  
25 cm – 10"  
**Cooley**

3

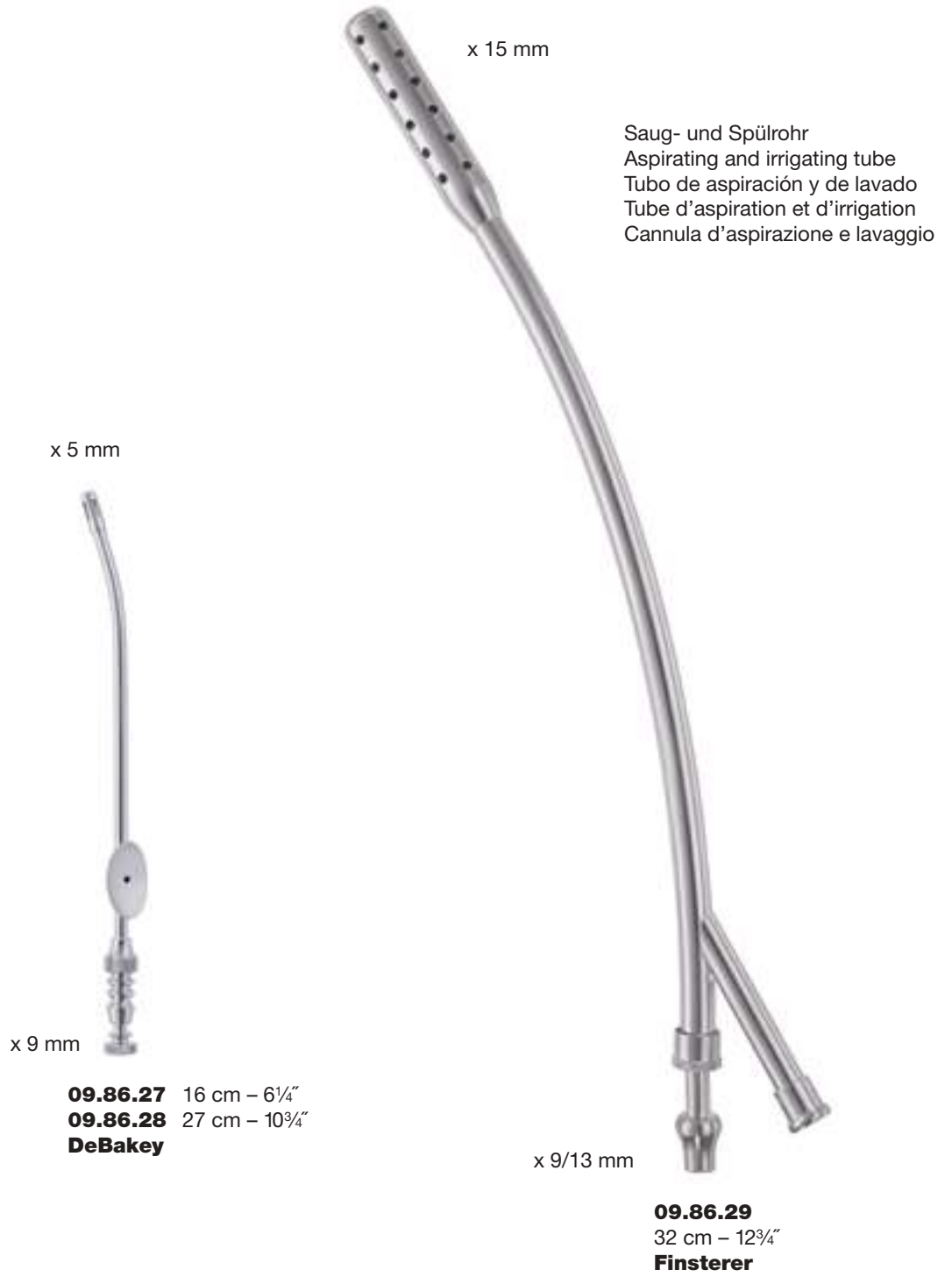

**Instrumente für Krampfadern,  
Venen und Endarterektomie**

**Instruments for Varicose Veins,  
Veins and Endarterectomy**

**Instrumentos para varices,  
Venas y endarterectomía**

**Instruments pour varices,  
Veines et endartérectomie**

**Strumenti per varici,  
Vene ed endarterectomia**



**Krampfaderinstrumente**  
**Varicose Vein Instruments**  
**Instrumentos para varices**  
**Instrumentos pour varices**  
**Strumenti per varici**

4



Krampfaderbesteck komplett in Metalletui  
 Varicose vein probe set complete in metal case  
 Juego para varices completo en caja metálica  
 Trousse pour varices complète en boîte métallique  
 Set di sonde per varici completo in astuccio metallico

**09.95.00**  
**Nabatoff**

<b>09.95.11</b>	Zugseil	Traction cable	Cable de tracción	Cable de traction	Fune di trazione
<b>09.95.12</b>	Handgriff	Handle	Mango	Manche	Manico
<b>09.95.16</b>	Kunststoffspitze	Plastic probe tip	Punta plástica	Pointe en plastique	Punta di plastica
<b>09.95.18</b>	Metallspitze	Metal probe tip	Punta metálica	Pointe en métal	Punta d'acciaio
<b>09.95.26</b>	Olive x 6 mm	Olive x 6 mm	Oliva x 6 mm	Olive x 6 mm	Oliva x 6 mm
<b>09.95.29</b>	Olive x 9 mm	Olive x 9 mm	Oliva x 9 mm	Olive x 9 mm	Oliva x 9 mm
<b>09.95.32</b>	Olive x 12 mm	Olive x 12 mm	Oliva x 12 mm	Olive x 12 mm	Oliva x 12 mm



**09.95.11**  
 90 cm – 35<sup>3</sup>/<sub>8</sub>"

Zugseil  
 Traction cable  
 Cable de tracción  
 Cable de traction  
 Fune di trazione

**09.95.39**

Metalletui allein  
 Metal case only  
 Estuche de metal suelto  
 Boîte métallique seule  
 Astuccio metallico solo



**09.95.12**

Handgriff  
 Handle  
 Mango  
 Manche  
 Manico

**09.95.16**

Kunststoffspitze  
 Plastic probe tip  
 Punta plástica  
 Pointe en plastique  
 Punta di plastica

**09.95.18**  
 x 3 mm

Metallspitze  
 Metal probe tip  
 Punta metálica  
 Pointe en métal  
 Punta d'acciaio

**09.95.26**  
 x 6 mm

**09.95.29**  
 x 9 mm

**09.95.32**  
 x 12 mm

**09.95.35**  
 x 15 mm

Oliven  
 Olives  
 Olivas  
 Olives  
 Olive

**Krampfaderinstrumente, Veneninstrumente  
Varicose Vein Instruments, Vein Instruments  
Instrumentos para varices, Instrumentos para venas  
Instruments pour varices, Instruments pour les veines  
Strumenti per varici, Strumenti per vene**



Krampfaderbesteck komplett in Metalletui  
Varicose vein probe set complete in metal case  
Juego para varices completo en caja metálica  
Trousse pour varices complète en boîte métallique  
Set di sonde per varici completo in astuccio metallico

4

**09.95.40**

<b>09.95.41</b>	Zugseil	Traction cable	Cable de tracción	Cable de traction	Fune di trazione
<b>09.95.43</b>	Olive x 3 mm	Olive x 3 mm	Oliva x 3 mm	Olive x 3 mm	Oliva x 3 mm
<b>09.95.44</b>	Olive x 4 mm	Olive x 4 mm	Oliva x 4 mm	Olive x 4 mm	Oliva x 4 mm
<b>09.95.45</b>	Olive x 5 mm	Olive x 5 mm	Oliva x 5 mm	Olive x 5 mm	Oliva x 5 mm

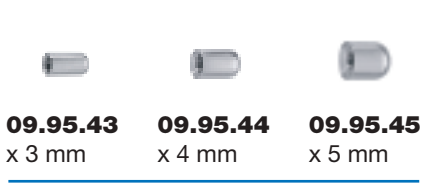

Oliven  
Olives  
Olivas  
Olives  
Olive



**09.95.39**

Metalletui allein  
Metal case only  
Estuche de metal suelto  
Boîte métallique seule  
Astuccio metallico solo

**09.95.41**  
45 cm – 17½"

Zugseil  
Traction cable  
Cable de tracción  
Cable de traction  
Fune di trazione

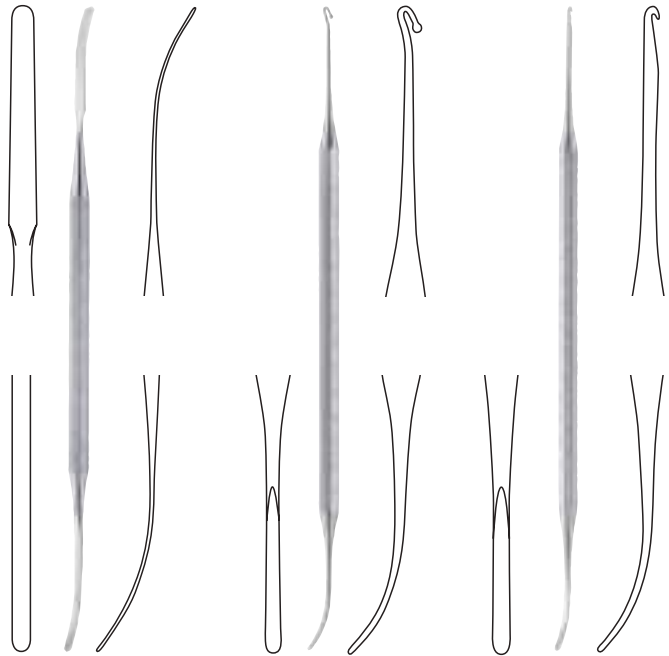

**09.95.91**  
18 cm – 7"  
**Varady**

Phlebo dissektor  
Phlebo dissector  
Disector de flebo  
Dissecteur phlébite  
Dissettore flebo

**09.95.92**  
18 cm – 7"  
**Varady**

Phleboextraktor  
Phleboextractor  
Extractor de flebo  
Extracteur phlébite  
Estrattore flebo

**09.95.93**  
18 cm – 7"  
**Varady**

Phleboextraktor  
Phleboextractor  
Extractor de flebo  
Extracteur phlébite  
Estrattore flebo



**Krampfaderinstrumente  
 Varicose Vein Instruments  
 Instrumentos para varices  
 Instruments pour varices  
 Strumenti per varici**

4



**09.95.81**  
4,8 mm



**09.95.82**  
7,2 mm



**09.95.83**  
9,6 mm

**Mayo**

Innen-x  
 Inner x  
 x interior  
 x intérieur  
 x interno

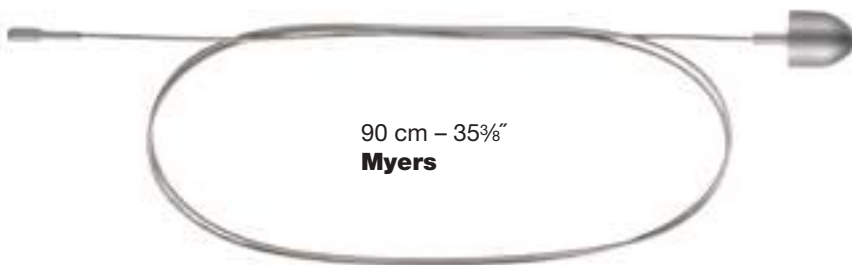

90 cm – 35<sup>3</sup>/<sub>8</sub>"  
**Myers**



**09.95.56**  
x 6 mm



**09.95.59**  
x 9 mm



**09.95.62**  
x 12 mm



**09.95.65**  
x 15 mm

**Myers**











39 cm – 15<sup>3</sup>/<sub>8</sub>"  
**Mayo**



**Endarterektomieinstrumente**  
**Endarterectomy Instruments**  
**Instrumentos para endarterectomía**  
**Instruments pour endartérectomie**  
**Strumenti per endarterectomia**



55 cm – 21 $\frac{3}{4}$ "

				
<b>09.96.02</b>	<b>09.96.03</b>	<b>09.96.04</b>	<b>09.96.06</b>	<b>09.96.07</b>
x 2 mm	x 3 mm	x 4 mm	x 6 mm	x 7 mm
				
<b>09.96.08</b>	<b>09.96.10</b>	<b>09.96.12</b>	<b>09.96.14</b>	
x 8,5 mm	x 10 mm	x 12 mm	x 14 mm	



**09.96.19**  
 12 cm – 4 $\frac{3}{8}$ "

Griff für Endarterektomie-Stripper  
 Handle for endarterectomy strippers  
 Mango para disectores para endoarteriotomia  
 Manche pour désoblitérateurs pour endarterectomía  
 Manico per disobliteratori per endarterectomia

4



**Gefäßspülkanülen**  
**Vascular Irrigation Cannulas**  
**Cánulas para lavado vascular**  
**Canules pour lavage des vaisseaux**  
**Cannule di lavaggio per vasi**

4

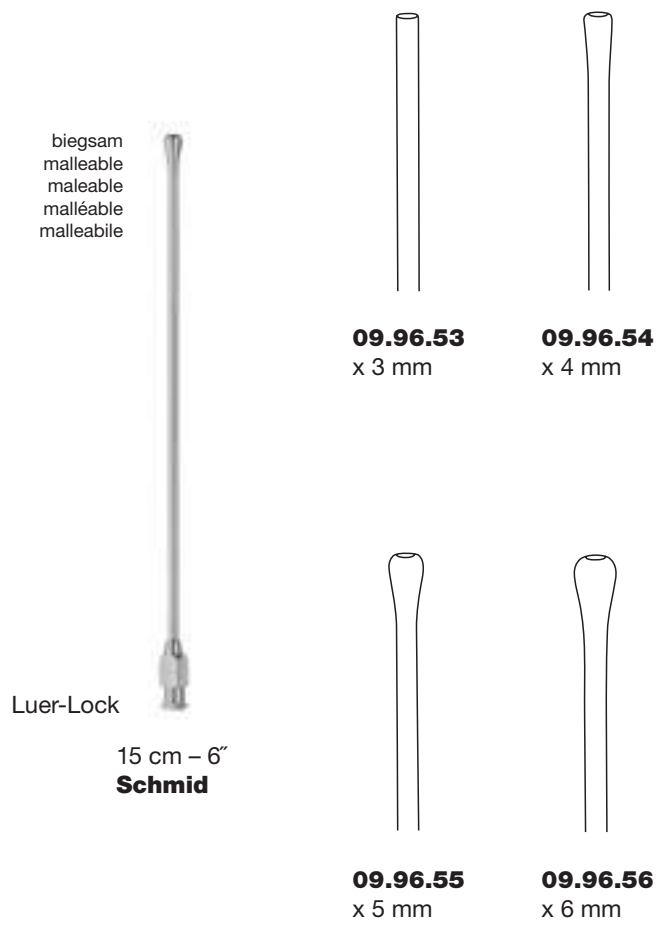

**Gefäßspatel**  
**Vascular Spatulas**  
**Espátulas vasculares**  
**Spatules vasculaires**  
**Spatole vascolari**



**Gefäßspatel**  
**Vascular Spatulas**  
**Espátulas vasculares**  
**Spatules vasculaires**  
**Spatole vascolari**

5



3 mm

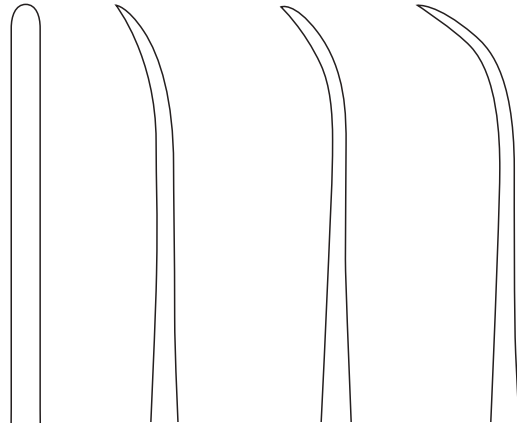

**09.96.71**

**09.96.72**

**09.96.73**

17 cm – 6¾"  
**Lemmon**



5 mm



**09.96.75**  
 14 cm – 5½"

4 mm



stumpf  
 blunt  
 roma  
 mousse  
 smusso

**57.35.19**  
 19 cm – 7½"  
**Davis**

3 mm



stumpf  
 blunt  
 roma  
 mousse  
 smusso

**57.35.20**  
 21 cm – 8¼"  
**Sachs**

7 mm



**Schmid** **09.96.77**  
 24 cm – 9½"

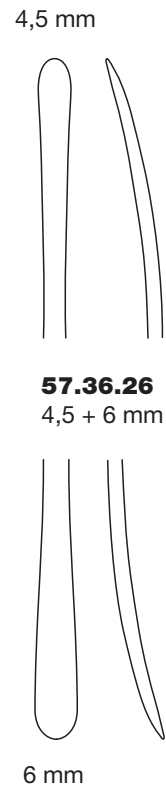
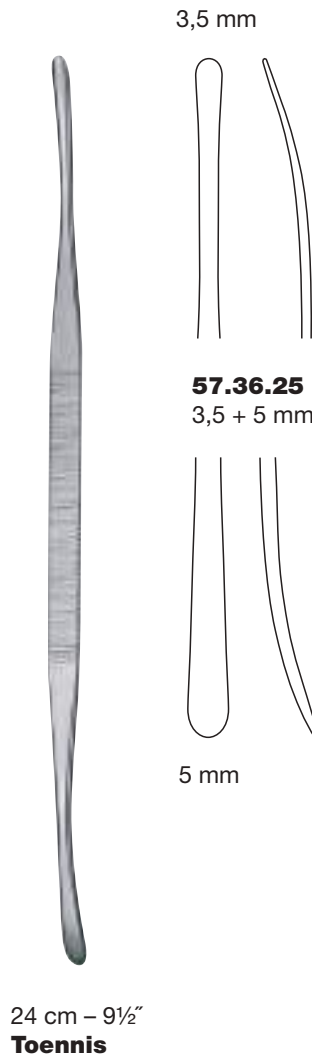
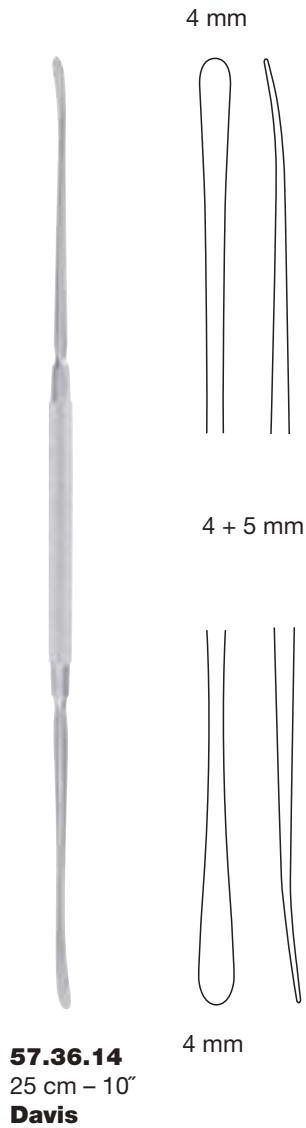



**Gefäßspatel**  
**Vascular Spatulas**  
**Espátulas vasculares**  
**Spatules vasculaires**  
**Spatole vascolari**

5

3 mm

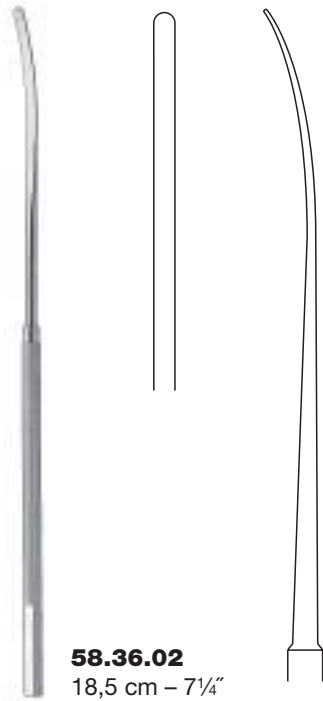

**58.36.02**  
18,5 cm – 7¼"

3 mm

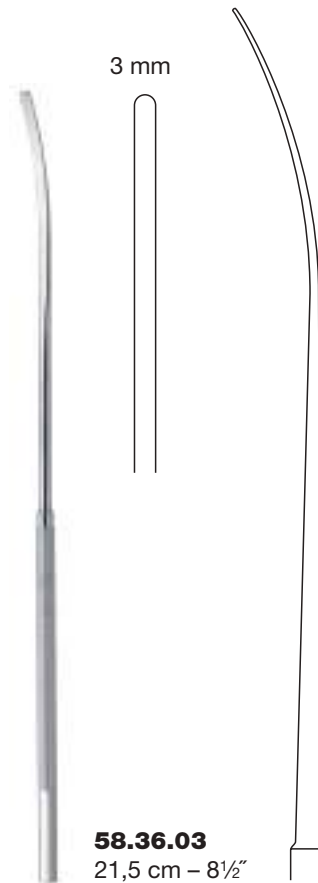

**58.36.03**  
21,5 cm – 8½"

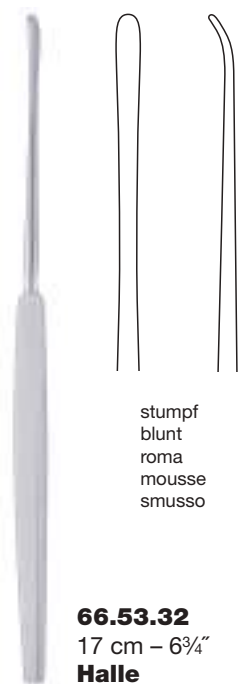

stumpf  
blunt  
roma  
mousse  
smusso

**66.53.32**  
17 cm – 6¾"  
**Halle**

medicoon

**Nadelhalter**  
**Needle Holders**  
**Porta-agujas**  
**Porte-aiguilles**  
**Port'aghi**



**Nadelhalter**  
**Needle Holders**  
**Porta-agujas**  
**Porte-aiguilles**  
**Port'aghi**

**“HM”**

**Nadelhalter mit Hartmetalleinlagen**  
**Needle Holders with Tungsten Carbide Inserts**  
**Porta-agujas con bocas revestidas de plaquitas de tungsteno**  
**Porte-aiguilles avec mors en tungstène**  
**Port'aghi con inserti di tungsteno**

6

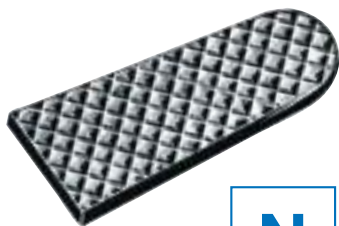

**NORMAL** 0,5 mm für Nadeln und Nahtmaterial bis Stärke 4-0  
**REGULAR** 0,5 mm for use with sutures up to size 4-0  
**NORMAL** 0,5 mm para agujas y material de sutura hasta el espesor de 4-0  
**NORMALE** 0,5 mm pour aiguilles et matériel à suture jusqu'à l'épaisseur de 4-0  
**NORMALE** 0,5 mm per aghi e materiale di sutura fino ad uno spessore di 4-0

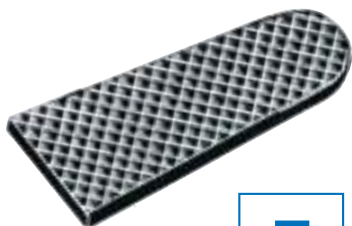

**FEIN** 0,4 mm für feine Nadeln und Nahtmaterial Stärke 5-0 und 6-0  
**FINE** 0,4 mm for delicate needles and sutures sizes 5-0 and 6-0  
**FINO** 0,4 mm para agujas finas y material de sutura de espesores 5-0 y 6-0  
**FINE** 0,4 mm pour aiguilles fines et matériel à suture d'épaisseurs 5-0 à 6-0  
**FINE** 0,4 mm per aghi fini e materiale di sutura di uno spessore di 5-0 e 6-0

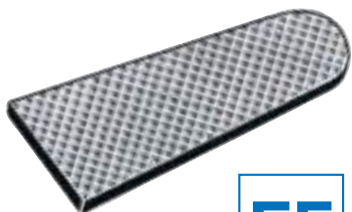

**EXTRA-FEIN** 0,3 mm für Mikro-Nadeln und Nahtmaterial bis Stärke 10-0  
**EXTRA-FINE** 0,3 mm for use with micro-needles and sutures up to size 10-0  
**EXTRA-FINO** 0,3 mm para micro-agujas y material de sutura hasta el espesor de 10-0  
**EXTRA-FINE** 0,3 mm pour micro-aiguilles et matériel à suture jusqu'à l'épaisseur de 10-0  
**EXTRA-FINE** 0,3 mm per micro-aghi e materiale di sutura fino ad uno spessore di 10-0

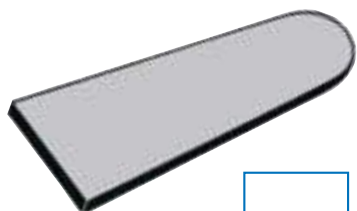

**GLATT** für feine Nadeln und Nahtmaterial Stärke 7-0 bis 10-0  
**SMOOTH** for delicate needles and sutures sizes 7-0 and 10-0  
**LISO** para agujas finas y material de sutura de espesores 7-0 y 10-0  
**LISSE** pour aiguilles fines et matériel à suture d'épaisseurs 7-0 à 10-0  
**LISCIA** per aghi fini e materiale di sutura di uno spessore di 7-0 e 10-0





F

**10.12.63**  
 13,5 cm – 5<sup>3</sup>/<sub>8</sub>"  
**Halsey "HM"**

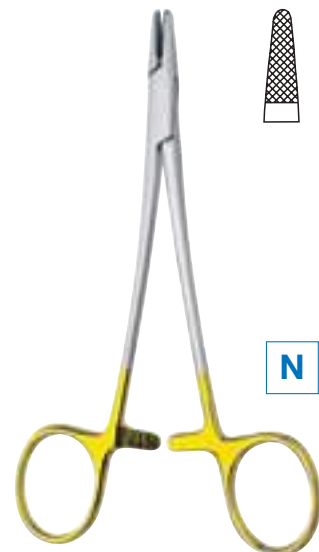

N

**10.14.64**  
 14 cm – 5<sup>1</sup>/<sub>2</sub>"  
**Baumgartner "HM"**

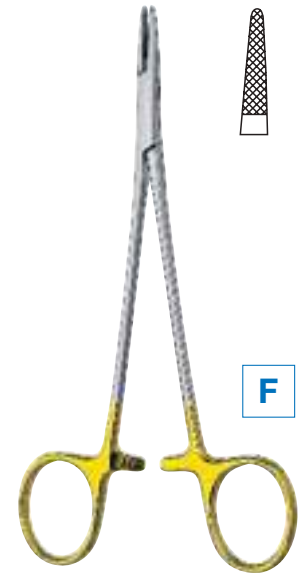

F

**10.20.64**  
 15 cm – 6"  
**Baby Crile-Wood "HM"**



N

**Mayo-Hegar "HM"**



**10.18.65**  
**10.18.85\***  
 15 cm – 6"



**10.18.68**  
**10.18.88\***  
 18 cm – 7<sup>1</sup>/<sub>8</sub>"



**10.18.70**  
**10.18.90\***  
 20 cm – 8"



**10.18.73**  
**10.18.93\***  
 23 cm – 9"



**10.18.74**  
 24 cm – 9<sup>1</sup>/<sub>2</sub>"

\* Titan  
 Titanium  
 Titanio  
 Titane  
 Titanio



**10.18.76**  
 26 cm – 10<sup>1</sup>/<sub>4</sub>"



**10.18.80**  
 30 cm – 11<sup>3</sup>/<sub>4</sub>"



**Nadelhalter  
Needle Holders  
Porta-agujas  
Porte-aiguilles  
Port'aghi**

6



F

- |                               |                                   |                               |                               |                                    |                                    |
|-------------------------------|-----------------------------------|-------------------------------|-------------------------------|------------------------------------|------------------------------------|
|                               |                                   |                               |                               |                                    |                                    |
| <b>10.20.65</b><br>15 cm – 6" | <b>10.20.68</b><br>18 cm – 7 1/8" | <b>10.20.70</b><br>20 cm – 8" | <b>10.20.73</b><br>23 cm – 9" | <b>10.20.75</b><br>25 cm – 10 1/4" | <b>10.20.80</b><br>30 cm – 11 3/4" |

**Crile-Wood "HM"  
(DeBakey "HM")**



F

- |                               |                               |
|-------------------------------|-------------------------------|
|                               |                               |
| <b>10.21.70</b><br>20 cm – 8" | <b>10.21.73</b><br>23 cm – 9" |

**Julian "HM"**



F

- |                                   |                                     |                                    |
|-----------------------------------|-------------------------------------|------------------------------------|
|                                   |                                     |                                    |
| <b>10.22.68</b><br>18 cm – 7 1/8" | <b>10.22.72</b><br>23,5 cm – 9 1/4" | <b>10.22.77</b><br>27 cm – 10 3/4" |

**Sarot "HM"**



- |                               |                                   |                               |                               |
|-------------------------------|-----------------------------------|-------------------------------|-------------------------------|
|                               |                                   |                               |                               |
| <b>10.24.65</b><br>15 cm – 6" | <b>10.24.68</b><br>18 cm – 7 1/8" | <b>10.24.70</b><br>20 cm – 8" | <b>10.24.73</b><br>23 cm – 9" |

**micro-slim "HM"**



14 cm – 5 1/2"  
**Intracardiac "HM"**



- |                                   |                               |                                   |
|-----------------------------------|-------------------------------|-----------------------------------|
|                                   |                               |                                   |
| <b>10.26.63</b><br>13 cm – 5 1/8" | <b>10.26.65</b><br>15 cm – 6" | <b>10.26.68</b><br>18 cm – 7 1/8" |
|                                   |                               |                                   |
| <b>10.26.70</b><br>20 cm – 8"     | <b>10.26.73</b><br>23 cm – 9" |                                   |

**Ryder (French Eye) "HM"**



- |                                   |                               |                                   |
|-----------------------------------|-------------------------------|-----------------------------------|
|                                   |                               |                                   |
| <b>10.28.63</b><br>13 cm – 5 1/8" | <b>10.28.65</b><br>15 cm – 6" | <b>10.28.68</b><br>18 cm – 7 1/8" |
|                                   |                               |                                   |
| <b>10.28.70</b><br>20 cm – 8"     | <b>10.28.73</b><br>23 cm – 9" |                                   |

**Mini-Ryder "HM"**



**Nadelhalter  
Needle Holders  
Porta-agujas  
Porte-aiguilles  
Port'aghi**

6



**10.29.63**    **10.29.65**  
13 cm – 5 1/8"    15 cm – 6"

**10.29.68**    **10.29.70**  
18 cm – 7 1/8"    20 cm – 8"

**10.29.73**  
23 cm – 9"



**10.29.64**    **10.29.66**  
13 cm – 5 1/8"    15 cm – 6"

**10.29.69**    **10.29.71**  
18 cm – 7 1/8"    20 cm – 8"

**10.29.74**  
23 cm – 9"



**Ryder slim "HM"**



**10.30.65**    **10.30.69**    **10.30.71**  
14 cm – 5 1/2"    18 cm – 7 1/8"    20 cm – 8"



**10.30.74**  
23 cm – 9"

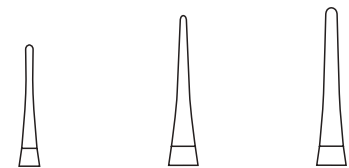

**10.30.64**    **10.30.68**    **10.30.70**  
14 cm – 5 1/2"    18 cm – 7 1/8"    20 cm – 8"



**10.30.73**  
23 cm – 9"

extrem fein  
extremely delicate  
muy fino  
très fin  
molto fino

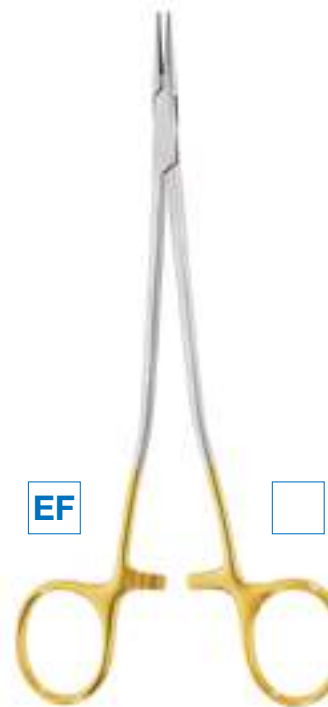

**Microvascular "HM"  
Eufrate Pasqué**



**N**

**10.31.71**  
 21 cm – 8¼”  
**Heaney “HM”**



**F**

**10.35.70** 20 cm – 8”  
**10.35.74** 24 cm – 9½”  
**Stratte “HM”**



**N**



**10.37.70**  
 20 cm – 8”



**10.37.74**  
 24 cm – 9½”



**10.37.76**  
 26 cm – 10¼”



**10.37.80**  
 30 cm – 11¾”

**Bozemann**  
**(Wertheim) “HM”**



**Nadelhalter  
Needle Holders  
Porta-agujas  
Porte-aiguilles  
Port'aghi**



**10.39.17**  
17 cm - 6 $\frac{3}{4}$ "  
**Senning**



**10.40.77**  
27 cm - 10 $\frac{3}{4}$ "  
**Masson "HM"**



**10.39.64**  
15 cm - 6"

**10.39.66**  
17 cm - 6 $\frac{3}{4}$ "



**10.39.65**  
15 cm - 6"

**10.39.67**  
17 cm - 6 $\frac{3}{4}$ "

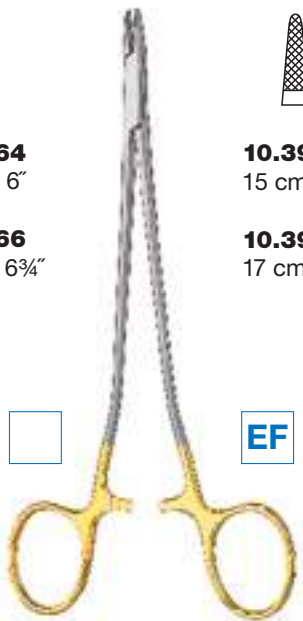

**Senning "HM"**



**10.40.78**  
28 cm – 11"  
**Wangensteen "HM"**



**10.43.77**  
27 cm – 10¾"  
**Finochietto "HM"**



**Nadelhalter**  
**Needle Holders**  
**Porta-agujas**  
**Porte-aiguilles**  
**Port'aghi**

6



**N**

**Mathieu "HM"**



**11.20.64**  
14 cm – 5½"



**11.20.67**  
17 cm – 6¾"



**11.20.70**  
20 cm – 8"



**11.20.74**  
24 cm – 9½"



**EF**

**Mathieu-Ryder Micro "HM"**

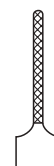

**11.23.67**  
17 cm – 6¾"

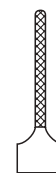

**11.23.70**  
20 cm – 8"

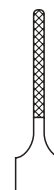

**11.23.74**  
24 cm – 9½"



**F**

**Lichtenberg "HM"**



**11.26.70**  
20 cm – 8"



**11.26.75**  
25 cm – 10"



**N**

**Toennis "HM"**



**11.34.66**  
16 cm – 6¼"



**11.34.68**  
18 cm – 7⅛"



**11.34.70**  
20 cm – 8"



**N**

**Langenbeck "HM"**



**11.36.66**  
16 cm – 6¼"



**11.36.68**  
18 cm – 7⅛"



**11.36.70**  
20 cm – 8"



**Mikro Nadelhalter**  
**Micro Needle Holders**  
**Micro Porta-agujas**  
**Micro Porte-aiguilles**  
**Micro Port'aghi**



6



**Castroviejo**



**11.62.14**  
14 cm – 5½"



**11.62.15**  
14 cm – 5½"

**11.62.17**  
17 cm – 6¾"

**11.62.18**  
17 cm – 6¾"

mit Sperre  
with catch  
con cremallera  
avec crémaillère  
con cremagliera



**11.62.64**  
14 cm – 5½"

**11.62.67**  
17 cm – 6¾"



**Castroviejo "HM"**



**11.62.84**  
14 cm – 5½"

**11.62.87**  
17 cm – 6¾"



**11.62.63**  
13 cm – 5⅛"  
**Castroviejo "HM"**



mit Sperre  
with catch  
con cremallera  
avec crémaillère  
con cremagliera



14,5 cm – 5¾"  
**Castroviejo-micro**



**11.70.22**



**11.70.23**



14,5 cm – 5¾"  
**Castroviejo-micro**



**11.70.24**



**11.70.25**

mit Sperre  
with catch  
con cremallera  
avec crémaillère  
con cremagliera



14,5 cm – 5¾"  
**Castroviejo (Koshima)**



**11.70.26**



**11.70.27**

mit Sperre  
with catch  
con cremallera  
avec crémaillère  
con cremagliera



14,5 cm – 5¾"  
**Castroviejo (Koshima)**



**11.70.28**



**11.70.29**

Ultra fein  
Ultra fine  
Ultra fino  
Ultra delicate  
Molto delicato



**Mikro Nadelhalter**  
**Micro Needle Holders**  
**Micro Porta-agujas**  
**Micro Porte-aiguilles**  
**Micro Port'aghi**

6



**11.74.13**  
 11,5 cm – 4½"

**11.74.23**  
 14 cm – 5½"



**11.74.15**  
 11,5 cm – 4½"

**11.74.25**  
 14 cm – 5½"

mit Sperre  
 with catch  
 con cremallera  
 avec crémaillère  
 con cremagliera

**Barraquer**

**Barraquer**



**11.80.68**  
 18,5 cm – 7¼"

**11.80.71**  
 21 cm – 8¼"



**11.82.68**  
 18,5 cm – 7¼"

**11.82.71**  
 21 cm – 8¼"

mit Sperre  
 with catch  
 con cremallera  
 avec crémaillère  
 con cremagliera



**Jacobson "HM"**

**Jacobson "HM"**



**11.82.18**  
 18,5 cm – 7¼"

**11.82.21**  
 21 cm – 8¼"

mit Sperre  
 with catch  
 con cremallera  
 avec crémaillère  
 con cremagliera

**Jacobson**



**11.84.68** **11.85.68**



18 cm – 7⅛"  
**Jacobson "HM"**



**11.86.68** **11.87.68**

mit Sperre  
 with catch  
 con cremallera  
 avec crémaillère  
 con cremagliera



18 cm – 7⅛"  
**Jacobson "HM"**

**Mikro Nadelhalter  
Micro Needle Holders  
Micro Porta-agujas  
Micro Porte-aiguilles  
Micro Port'aghi**



6



	0,4 mm	0,4 mm	0,5 mm	0,5 mm
13 cm – 5 1/8"	<b>12.12.54</b>	<b>12.12.55</b>		<b>12.12.59</b>
15 cm – 6"	<b>12.15.56*</b>	<b>12.15.57*</b>		
	<b>12.15.76</b>	<b>12.15.77</b>		
18 cm – 7 1/8"	<b>12.18.56*</b>	<b>12.18.57*</b>		
	<b>12.18.76</b>	<b>12.18.77</b>	<b>12.18.80</b>	<b>12.18.81</b>
21 cm – 9"	<b>12.21.56*</b>	<b>12.21.57*</b>	<b>12.21.60*</b>	<b>12.21.61*</b>
	<b>12.21.76</b>	<b>12.21.77</b>	<b>12.21.80</b>	<b>12.21.81</b>

\* Diamantbeschichtung  
diamond dusted  
con recubrimiento de diamante  
avec couche diamantée  
con rivestimento di diamante



mit Sperre  
with catch  
con cremallera  
avec crémaillère  
con cremagliera

	0,4 mm	0,4 mm	0,5 mm	0,5 mm
13 cm – 5 1/8"	<b>12.12.56</b>	<b>12.12.57</b>		<b>12.12.61</b>
15 cm – 6"	<b>12.15.66*</b>	<b>12.15.67*</b>		
	<b>12.15.78</b>	<b>12.15.79</b>		
18 cm – 7 1/8"	<b>12.18.66*</b>	<b>12.18.67*</b>		
	<b>12.18.78</b>	<b>12.18.79</b>	<b>12.18.82</b>	<b>12.18.83</b>
21 cm – 9"	<b>12.21.66*</b>	<b>12.21.67*</b>	<b>12.21.70*</b>	<b>12.21.71*</b>
	<b>12.21.78</b>	<b>12.21.79</b>	<b>12.21.82</b>	<b>12.21.83</b>

\* Diamantbeschichtung  
diamond dusted  
con recubrimiento de diamante  
avec couche diamantée  
con rivestimento di diamante



**Mikro Nadelhalter, TITAN**  
**Micro Needle Holders, TITANIUM**  
**Micro Porta-agujas, TITANIO**  
**Micro Porte-aiguilles, TITANE**  
**Micro Port'aghi, TITANIO**

Ti

6



15 cm – 6"	<b>12.16.75</b>	<b>12.16.77</b>
18 cm – 7 1/8"	<b>12.18.85</b>	<b>12.18.87</b>
21 cm – 9"	<b>12.21.95</b>	<b>12.21.97</b>



15 cm – 6"	<b>12.16.76</b>	<b>12.16.78</b>
18 cm – 7 1/8"	<b>12.18.86</b>	<b>12.18.88</b>
21 cm – 9"	<b>12.21.96</b>	<b>12.21.98</b>

mit Sperre  
with catch  
con cremallera  
avec crémaillère  
con cremagliera

**Mikro Nadelhalter**  
**Micro Needle Holders**  
**Micro Porta-agujas**  
**Micro Porte-aiguilles**  
**Micro Port'aghi**



6



**12.15.30**



**12.15.31**

15 cm – 6"  
**micro 2000**



**12.15.32**



**12.15.33**

15 cm – 6"  
**micro 2000**

mit Sperre  
 with catch  
 con cremallera  
 avec crémaillère  
 con cremagliera



**12.15.50**



**12.15.51**

16 cm – 6¼"  
**Yasargil**



**Mikro Nadelhalter**  
**Micro Needle Holders**  
**Micro Porta-agujas**  
**Micro Porte-aiguilles**  
**Micro Port'aghi**

micro 2000

6



micro 2000

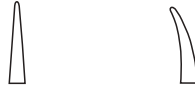

15 cm – 6"	<b>12.15.70</b>	<b>12.15.71</b>
18 cm – 7 1/8"	<b>12.18.70</b>	<b>12.18.71</b>

Leichtmetall-Instrumente mit  
 blau eloxierten Rundgriffen  
 | geringes Gewicht  
 | gut ausbalanciert  
 | sehr handlich  
 | ermüdungsfreies Arbeiten  
 | leicht zu pflegen  
 | korrosionsbeständig

Light-weight instruments with  
 blue-colored anodized round handles  
 | extremely light weight  
 | well balanced  
 | easy to handle  
 | fatigueless working  
 | easy to maintain  
 | corrosion-resistant

Instrumentos de metal ligero  
 con mangos redondos  
 anodizados en azul  
 | peso muy reducido  
 | bien equilibrados  
 | operar sin fatigarse  
 | fácil manejo  
 | fácil mantenimiento  
 | resistente a la corrosión



micro 2000

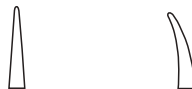

15 cm – 6"	<b>12.15.72</b>	<b>12.15.73</b>
18 cm – 7 1/8"	<b>12.18.72</b>	<b>12.18.73</b>
	<b>12.18.74*</b>	<b>12.18.75*</b>

\* Diamantbeschichtung  
 diamond dusted  
 con recubrimiento de diamante  
 avec couche diamantée  
 con rivestimento di diamante

Instrumente en métal léger,  
 avec manches ronds anodisés en bleu  
 | poids réduit  
 | bien équilibrés  
 | très maniables  
 | travail sans fatigue  
 | entretien facile  
 | résistants à la corrosion

Strumenti di metallo leggero  
 con manici rotondi, anodizzati azzurri  
 | peso minimo  
 | equilibrio perfetto  
 | maneggevoli  
 | lavoro non affaticoso  
 | manutenzione minima

mit Sperre  
 with catch  
 con cremallera  
 avec crémaillère  
 con cremagliera



**Mikro Nadelhalter  
 Micro Needle Holders  
 Micro Porta-agujas  
 Micro Porte-aiguilles  
 Micro Port'aghi**



6

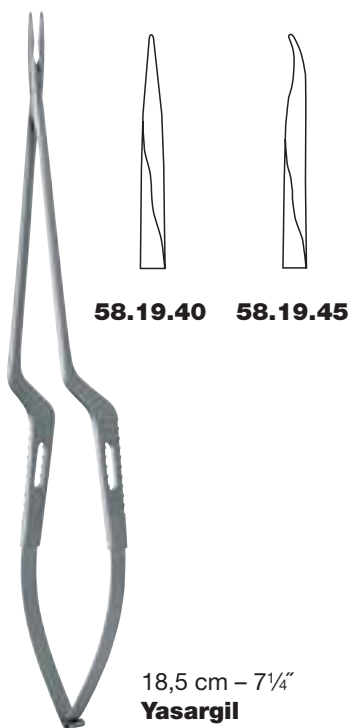
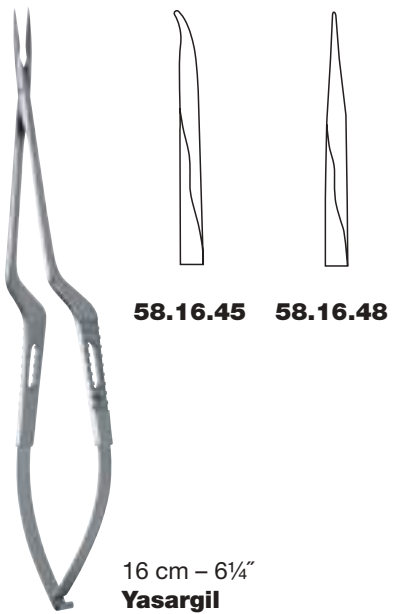

**Drahtinstrumente  
Knochendrähte**

**Wire Instruments  
Bone Suturing Wires**

**Instrumentos para alambre  
Alambres para huesos**

**Instruments pour fils métalliques  
Fils d'acier à os**

**Strumenti per fili d'acciaio  
Filo d'acciaio per ossa**





**Drahtscheren, Drahtkneifzangen**  
**Wire Cutters, Wire Cutting Pliers**  
**Tijeras para cortar hilo de acero, Alicates**  
**Ciseaux coupe-fil, Pinces coupe-fil**  
**Forbici per fili d'acciaio, Tenaglie tagliafili**

7

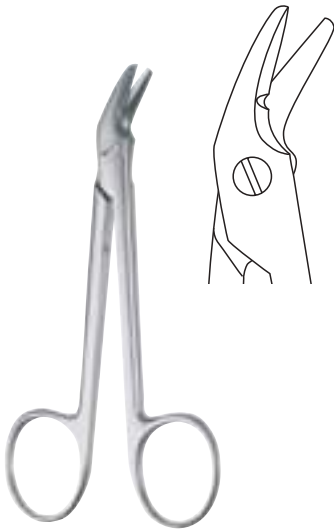

**14.23.12**  
 12 cm – 4¾"  
**Universal**

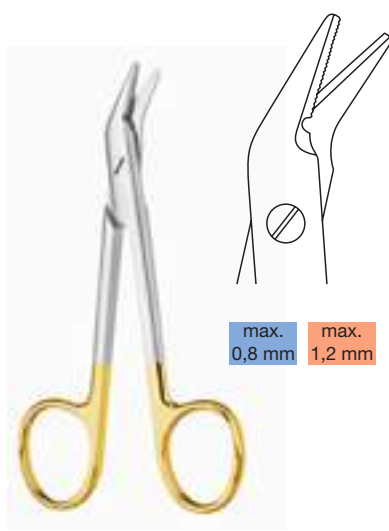

max. 0,8 mm max. 1,2 mm

**14.23.62**  
 12 cm – 4¾"  
**Universal "HM"**

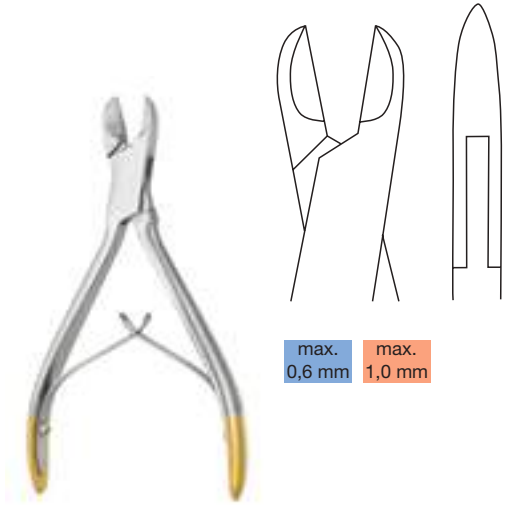

max. 0,6 mm max. 1,0 mm

**14.30.11**  
 12 cm – 4¾"  
**"HM"**

max. x  
 harte Drähte  
 hard wires  
 alambres duros  
 fils durs  
 fili duri

max. x  
 weiche Drähte  
 soft wires  
 alambres blandos  
 fils mous  
 fili molli

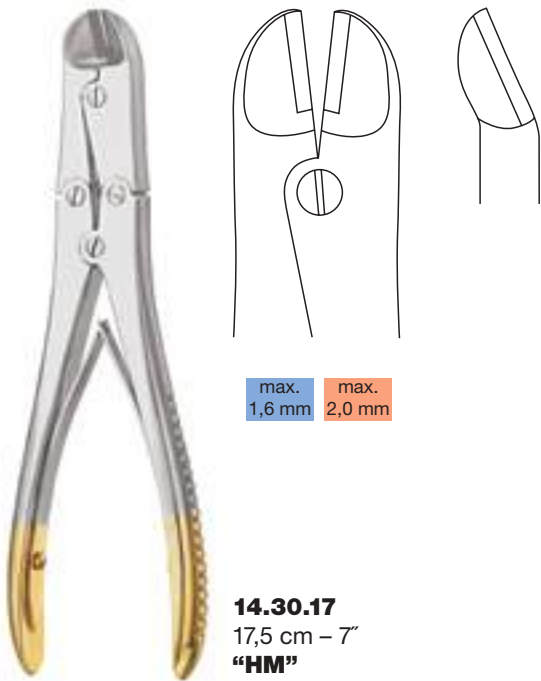

max. 1,6 mm max. 2,0 mm

**14.30.17**  
 17,5 cm – 7"  
**"HM"**



max. 1,5 mm max. 2,0 mm

**14.30.28**  
 19 cm – 7½"



Kunststoffbacken halten den Draht nach dem Durchtrennen in der Zange fest.

Plastic inserts hold wire piece after being cut.

Mordazas de plástico retienen el alambre después del corte.

Mors en plastique tiennent le fil après couper.

Le guance di plastica sostengono il filo nel morso della pinza dopo il taglio



### 76.45.85

Drahtkneifzange mit auswechselbaren Hartmetallschneiden, inkl. Service-Set (76.45.86).

Inhalt Service-Set: Ersatzschneiden "HM" (Paar) 76.45.87; Kunststoffbacken (Paar) 76.45.88; Schrauben (Paar) 76.45.89; Schraubendreher 76.45.90.

Wire cutting pliers with exchangeable TC edges, incl. service set (76.45.86).

Contents of service set:  
 Replacement TC edges (pair) 76.45.87  
 Plastic inserts (pair) 76.45.88  
 Screws (pair) 76.45.89  
 Screwdriver 76.45.90

Pinza para cortar alambre con hojas intercambiables de tungsteno, incl. set de servicio (76.45.86).

Contenido del set de servicio: Hojas de tungsteno de repuesto (par) 76.45.87  
 Hojas de plástico (par) 76.45.88  
 Tornillos (par) 76.45.89  
 Destornillador 76.45.90

Pince coupe-fils avec lames en tungstène interchangeables, set de service inclut (76.45.86).

Contenu du set de service: Lames de rechange en tungstène (paire) 76.45.87  
 mors en plastique (paire) 76.45.88  
 vis (paire) 76.45.89  
 tournevis 76.45.90

Tenaglie tagliafili, intercambiabile, completo con set di servizio (76.45.86).

Contenuto del set di servizio:  
 Lama TC (paio) 76.45.87;  
 Guance di plastica (paio) 76.45.88;  
 Viti (paio) 76.45.89;  
 Cacciavite 76.45.90

max. x  
 harte Drähte  
 hard wires  
 alambres duros  
 fils durs  
 fili duri



max.  
 2,5 mm

**76.45.73**  
 23 cm – 9"  
 "HM"



max. x 1,8 mm

**76.45.85**  
 20 cm – 8"  
 Easy Cut "HM"



**Drahtspannzangen**  
**Wire Twisting Forceps**  
**Pinzas-tensoras de alambre**  
**Pinces serre-fil**  
**Pinze tenda fili d'acciaio**



**14.40.15**  
15 cm - 6"  
**Niro**



**14.40.65**  
15 cm - 6"  
**Niro "HM"**



**14.41.65**  
15 cm - 6"  
**"HM"**



**14.44.17**  
17 cm - 6 $\frac{3}{4}$ "  
**Medicon**



**14.44.67**  
17 cm - 6 $\frac{3}{4}$ "  
**Medicon "HM"**

7

**Drahtspannzangen, Flachzangen**  
**Wire Twisting Forceps, Flat Nose Pliers**  
**Pinzas-tensoras de alambre, Alicates de pico plano**  
**Pinces serre-fil, Pinces plates**  
**Pinze tenda fili d'acciaio, Tenaglie piatte**



7



**14.46.14**  
14 cm – 5½"



**14.46.15**  
15 cm – 6"  
**Universal**



**68.04.86**  
14 cm – 5½"  
**Obwegeser**



**390.10.10**  
14 cm – 5½"



18 cm – 7⅛"

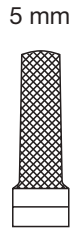

**14.48.05**

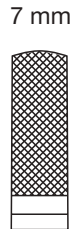

**14.48.07**

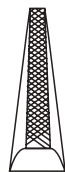

**14.48.04**



17 cm – 6¾"



**76.45.10**



**76.45.15**



**76.45.19**  
19 cm – 7½"



**Drahtspannzangen, Knochendrähte**  
**Wire Twisting Forceps, Bone Suturing Wires**  
**Pinzas-tensoras de alambre, Alambres para huesos**  
**Pinces serre-fil, Fils d'acier à os**  
**Pinze tenda fili d'acciaio, Filo d'acciaio per ossa**

7



**14.48.03**  
 16 cm – 6¼"  
**Corwin-Hegar "HM"**



Maulteile gerieft  
 serrated jaws  
 boca estriada  
 mors striés  
 morsi striati

**14.48.01**  
 17 cm – 6¾"  
**"HM"**

aus nichtrostendem Implantatstahl nach:  
 certified stainless steel for implants according to:  
 de acero inoxidable especial para implantes según:  
 en acier inoxydable spécial pour implants selon:  
 in acciaio inossidabile speciale per impianti secondo:

DIN 17443 (ISO 5832/1)



Rolle zu 10 m, weich  
 Coil 10 m (33.3 ft.), soft  
 Rollo de 10 m, dulce  
 Rouleau de 10 m, souple  
 Rotolo da 10 m, dolce

<b>76.01.02</b>	x 0,25 mm – 31 G
<b>76.01.03</b>	x 0,30 mm – 29 G
<b>76.01.04</b>	x 0,40 mm – 27 G
<b>76.01.05</b>	x 0,50 mm – 25 G
<b>76.01.06</b>	x 0,60 mm – 23 G
<b>76.01.07</b>	x 0,70 mm – 22 G
<b>76.01.08</b>	x 0,80 mm – 21 G
<b>76.01.09</b>	x 0,90 mm – 20 G
<b>76.01.10</b>	x 1,0 mm – 19 G
<b>76.01.12</b>	x 1,2 mm – 18 G
<b>76.01.15</b>	x 1,5 mm – 17 G
<b>76.01.18</b>	x 1,8 mm – 15 G
<b>76.01.20</b>	x 2,0 mm – 14 G

medicoon

**Gefäßclips**  
**Vessel Clips**  
**Clips vasculares**  
**Clips vasculaires**  
**Clip vascolari**



**Titan-Clips, Anlegezangen**  
**Titanium Clips, Applying Forceps**  
**Clips de titanio, Pinzas para aplicar clips**  
**Clips en titane, Pincès à appliquer les clips**  
**Clip in titanio, Pinza per applicare clip**



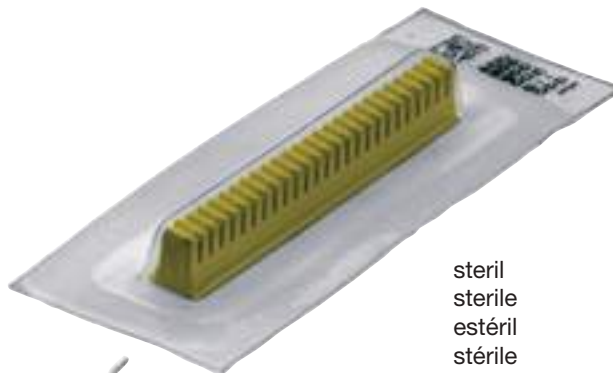

8



steril  
sterile  
estéril  
stérile  
sterili









Clipmagazine und Anlegezangen mit gleicher Farbcodierung  
 Clip Rack and Applying Forceps with matching color code  
 Dispositivo de clips y pinzas para aplicar clips con la misma codificación de color  
 Magasins de clips et pincès à appliquer les clips avec le même code de couleur  
 Caricatore per clip e pinze per applicare clip con codificazione di colore uguale





				
<b>Titan-Clips</b> <b>Titanium clips</b> <b>Clips de titanio</b> <b>Clips en titane</b> <b>Clip in titanio</b>	klein small pequeño petit piccolo	mittel medium mediano moyen medio	mittel groß medium large medio grande moyen-large medio grande	groß large grande large grande
<b>Packungsgrößen</b> <b>Packing unit</b> <b>Contenido de la caja</b> <b>Unités d'emballage</b> <b>Unità di confezione</b>	<b>56.50.01</b> 12 T 25	<b>56.50.02</b> 10 T 25	<b>56.50.03</b> 16 T 10	<b>56.50.04</b> 10 T 15
<b>Anlegezangen</b> <b>Applying forceps</b> <b>Pinzas para aplicación</b> <b>Pincès pour poser les clips</b> <b>Pinza per applicare clip</b>	<b>56.50.15</b> 15 cm – 6"	<b>56.50.25</b> 15 cm – 6"	<b>56.50.30</b> 20,5 cm – 8 1/8"	<b>56.50.40</b> 20,5 cm – 8 1/8"
<b>Farbe Ringgriffe</b> <b>Color of ring handles</b> <b>Color de los anillos de la pinza</b> <b>Couleur des manches à anneaux</b> <b>Colore dei manici ad anelli</b>				



**Acland**

8

							
		8 mm	11 mm	14 mm	17 mm	25 mm	36 mm
Arterie • Artery Arteria • Artère Arteria	<b>A</b>	<b>56.85.07</b>	<b>56.85.10</b>	<b>56.85.13</b>	<b>56.85.16</b>	<b>56.85.18</b>	<b>56.86.36</b>
Vene • Vein Vena • Veine Vena	<b>V</b>	<b>56.85.08</b>	<b>56.85.11</b>	<b>56.85.14</b>	<b>56.85.17</b>	<b>56.85.19</b>	<b>56.86.37</b>
Gefäß • Vessel Vaso • Vaisseau Vaso	<b>X</b>	0,4 – 1,0 mm	0,6 – 1,5 mm	1,0 – 2,25 mm	1,0 – 2,25 mm	1,5 – 3,5 mm	2,0 – 5,0 mm

				
		8 mm	11 mm	17 mm
Arterie • Artery Arteria • Artère Arteria	<b>A</b>	<b>56.85.87</b>	<b>56.85.80</b>	<b>56.85.96</b>
Vene • Vein Vena • Veine Vena	<b>V</b>	<b>56.85.88</b>	<b>56.85.81</b>	<b>56.85.97</b>
Gefäß • Vessel Vaso • Vaisseau Vaso	<b>X</b>	0,4 – 1,0 mm	0,6 – 1,5 mm	1,0 – 2,25 mm

Verpackungseinheit 2 Stück  
 Packing unit 2 pieces  
 Cajas con 2 piezas  
 Boîtes de 2 pièces  
 Unità di 2 pezzi

















**Mikro-Gefäßclips**  
**Micro Vessel Clips**  
**Micro clips vasculares**  
**Micro clips vasculaires**  
**Micro clip vascolari**

**Acland**

Approximatoren · Approximators · Aproximadores · Approximateurs · Approssimatori

8





							
Arterie • Artery Arteria • Artère Arteria	<b>A</b>	<b>56.85.47</b>	<b>56.85.50</b>	<b>56.85.53</b>	<b>56.85.56</b>	<b>56.85.58</b>	<b>56.86.58</b>
Vene • Vein Vena • Veine Vena	<b>V</b>	<b>56.85.48</b>	<b>56.85.51</b>	<b>56.85.54</b>	<b>56.85.57</b>	<b>56.85.59</b>	<b>56.86.59</b>
Gefäß • Vessel Vaso • Vaisseau Vaso	<b>X</b>	0,4 – 1,0 mm	0,6 – 1,5 mm	1,0 – 2,25 mm	1,0 – 2,25 mm	1,5 – 3,5 mm	2,0 – 5,0 mm

					
Arterie • Artery Arteria • Artère Arteria	<b>A</b>	<b>56.85.27</b>	<b>56.85.30</b>	<b>56.85.33</b>	<b>56.85.36</b>
Vene • Vein Vena • Veine Vena	<b>V</b>	<b>56.85.28</b>	<b>56.85.31</b>	<b>56.85.34</b>	<b>56.85.37</b>
Gefäß • Vessel Vaso • Vaisseau Vaso	<b>X</b>	0,4 – 1,0 mm	0,6 – 1,5 mm	1,0 – 2,25 mm	1,0 – 2,25 mm



**Acland**

Approximatoren · Approximators · Aproximadores · Approximateurs · Approssimatori

					
		8 mm	11 mm	14 mm	17 mm
Arterie • Artery Arteria • Artère Arteria	<b>A</b>	<b>56.85.67</b>	<b>56.85.70</b>	<b>56.85.73</b>	<b>56.85.76</b>
Vene • Vein Vena • Veine Vena	<b>V</b>	<b>56.85.68</b>	<b>56.85.71</b>	<b>56.85.74</b>	<b>56.85.77</b>
Gefäß • Vessel Vaso • Vaisseau Vaso	<b>X</b>	0,4 – 1,0 mm	0,6 – 1,5 mm	1,0 – 2,25 mm	1,0 – 2,25 mm

8



**Clip-Anlegepinzetten**  
**Clip Applying Forceps**  
**Pinzas para aplicar clips**  
**Pinces à appliquer les clips**  
**Pinze per applicare clip**

**Acland**

für Acland-Clips  
 for Acland clips  
 para clips Acland  
 pour clips Acland  
 per clip Acland

8

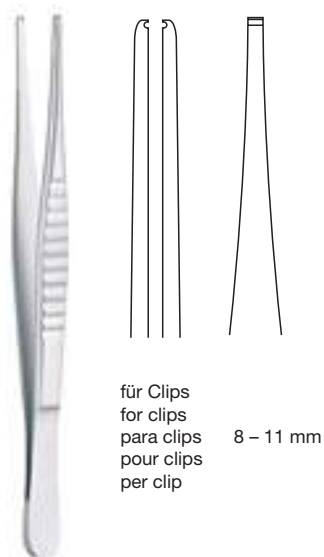

für Clips  
 for clips  
 para clips  
 pour clips  
 per clip  
 8 – 11 mm

**56.85.91**  
 14,5 cm – 5¾"  
**Acland**

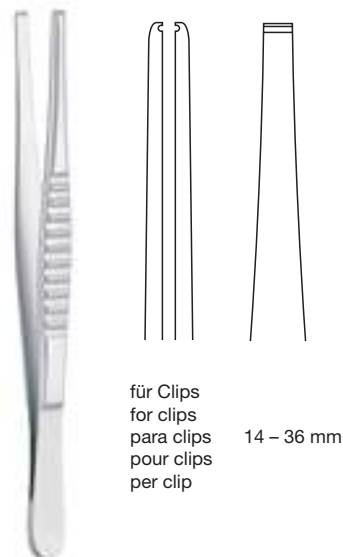

für Clips  
 for clips  
 para clips  
 pour clips  
 per clip  
 14 – 36 mm

**56.85.93**  
 14,5 cm – 5¾"  
**Acland**



für Clips  
 for clips  
 para clips  
 pour clips  
 per clip  
 8 – 36 mm

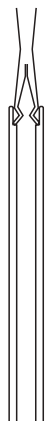

**56.85.98**  
 11 cm – 4½"  
**Acland**



**Mikro-Gefäßclips, Clip-Anlegepinzetten**  
**Micro Vessel Clips, Clip Applying Forceps**  
**Micro clips vasculares, Pinzas para aplicar clips**  
**Micro clips vasculaires, Pincès à appliquer les clips**  
**Micro clip vascolari, Pinze per applicare clip**

**Biemer**

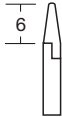
Einzelclips · Single clip · clip singular · clips seuls · clip singolari

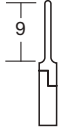
			
	<b>56.87.05</b>	<b>56.87.08</b>	<b>56.87.18</b>
Maullänge Jaw length Longitud de la boca Longueur des mors Lunghezza del morso	6,0 mm	9,0 mm	9,0 mm
Öffnungsweite Opening Apertura Largeur d'ouverture Apertura	4,0 mm	5,0 mm	5,0 mm
Schließkraft Closing pressure Fuerza de cierre Force de fermeture Forza di chiusura	30 – 40 g	30 – 40 g	20 – 25 g

Anlegepinzetten für Biemer Clips und Approximator 56.87.35

Applying forceps for Biemer clips and approximator 56.87.35

Pinzas aplicadoras para clips de Biemer y aproximador 56.87.35

Pincès à appliquer les clips de Biemer et approximateur 56.87.35

Pinze per applicare le clip di Biemer ed approssimatore 56.87.35



**56.87.35**  
 13 g/mm<sup>2</sup>  
**Biemer**

Approximator mit einstellbarem Clip-Abstand  
 Approximator with adjustable clip distance  
 Aproximador, distancia de clip ajustable  
 Approximateur, distance entre les clips ajustable  
 Approssimatore con distanza regolabile della clip

**56.87.30**

Set bestehend aus Approximator 56.87.35 und Anlegepinzette 56.87.46  
 Set consisting of approximator 56.87.35 and applying forceps 56.87.46  
 Set compuesto por aproximador 56.87.35 y pinza aplicadora 56.87.46  
 Jeu comprenant d'approximateur 56.87.35 et de pince à appliquer 56.87.46  
 Set composto da approssimatore 56.87.35 e pinza per applicare 56.87.46



**56.87.45**  
 14,5 cm – 5¾"  
**Biemer**

mit Sperre  
 with catch  
 con cremallera  
 avec crémaillère  
 con cremagliera



**56.87.46**  
 14,5 cm – 5¾"  
**Biemer**

ohne Sperre  
 without catch  
 sin cremallera  
 sans crémaillère  
 senza cremagliera



**Mikro-Gefäßclips**  
**Micro Vessel Clips**  
**Micro clips vasculares**  
**Micro clips vasculaires**  
**Micro clip vascolari**

**Biemer**

Approximatoren  
Approximators  
Aproximadores  
Approximateurs  
Approssimatori



**56.79.00**  
**Biemer**

**56.79.01**  
Nadeln allein (Paar)  
Needle only (pair)  
Agujas sueltas (par)  
Aiguilles seules (paire)  
Aghi soli (paio)

Nerv-Approximator komplett mit Schlüssel 56.87.49  
Approximator for nerves complete with key 56.87.49  
Aproximador para nervios, completo con llave 56.87.49  
Approximateur pour nerfs complet avec clé 56.87.49  
Approssimatore per nervi completo con chiave 56.87.49



**56.87.38**  
**Biemer**

Approximator mit einstellbarem Clip-Abstand und Druck,  
komplett mit Schlüssel 56.87.49

Approximator with adjustable clip  
distance and pressure, complete with key  
56.87.49

Aproximador, distancia de clip  
y presión ajustable, completo con llave  
56.87.49

Approximateur, distance entre les clips  
et pression ajustables, complet avec clé  
56.87.49

Approssimatore con distanza e pressione  
regolabile della clip, completo con chiave  
56.87.49



**56.87.49**

Ersatzschlüssel für  
Approximator 56.79.00 + 56.87.38

Replacement key for  
approximator 56.79.00 + 56.87.38

Llave de repuesto para el  
aproximador 56.79.00 + 56.87.38



Clé de rechange pour  
approximateur 56.79.00 + 56.87.38

Chiave di ricambio per  
approssimatore 56.79.00 + 56.87.38

**Mikro-Gefäßclips, Clip-Anlegepinzetten**  
**Micro Vessel Clips, Clip Applying Forceps**  
**Micro clips vasculares, Pinzas para aplicar clips**  
**Micro clips vasculaires, Pincès à appliquer les clips**  
**Micro clip vascolari, Pinze per applicare clip**

**Biemer-Müller**

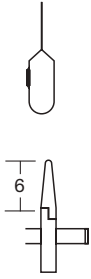
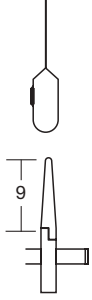
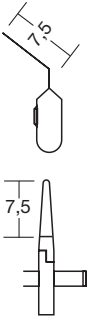
Approximatoren, doppelbeweglich  
 Approximators, double-action  
 Aproximadores, con doble acción  
 Approximateurs, deux clips mobiles  
 Approssimatori, con doppio movimento

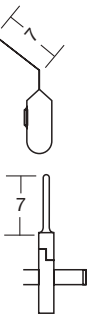
					
	<b>56.74.06</b>	<b>56.74.09</b>	<b>56.75.09</b>	<b>56.76.09</b>	<b>56.77.09</b>
Maullänge Jaw length Longitud de la boca Longueur des mors Lunghezza del morso	6,0 mm	9,0 mm	7,5 mm	7,0 mm	7,0 mm
Öffnungsweite Opening Apertura Largeur d'ouverture Apertura	3,0 mm	5,0 mm	5,0 mm	5,0 mm	5,0 mm
Schließkraft Closing pressure Fuerza de cierre Force de fermeture Forza di chiusura	25 – 30 g	25 – 30 g	25 – 30 g	25 – 30 g	25 – 30 g

Anlegepinzetten  
 Applying forceps  
 Pinzas aplicadoras  
 Pincès à appliquer  
 Pinze per applicare

für Biemer-Müller Approximatoren  
 for Biemer-Müller approximators  
 para aproximadores Biemer-Müller  
 pour approximateurs Biemer-Müller  
 per approssimatori Biemer-Müller

mit Sperre  
 with catch  
 con cremallera  
 avec crémaillère  
 con cremagliera

**56.87.45**  
 14,5 cm – 5¾"  
**Biemer**



ohne Sperre  
 without catch  
 sin cremallera  
 sans crémaillère  
 senza cremagliera

**56.87.46**  
 14,5 cm – 5¾"  
**Biemer**





**Mikro-Gefäßclips, Clip-Anlegepinzetten**  
**Micro Vessel Clips, Clip Applying Forceps**  
**Micro clips vasculaires, Pinzas para aplicar clips**  
**Micro clips vasculaires, Pincers à appliquer les clips**  
**Micro clips vascolari, Pinze per applicare clips**

Müller

8

	<b>56.78.01</b>	<b>56.78.02</b>	<b>56.78.03</b>	<b>56.78.04</b>
Maullänge Jaw length Longitud de la boca Longueur des mors Lunghezza del morso	9,0 mm	9,0 mm	9,0 mm	9,0 mm
Öffnungsweite Opening Apertura Largeur d'ouverture Apertura	5,0 mm	5,0 mm	5,0 mm	5,0 mm
Schließkraft Closing pressure Fuerza de cierre Force de fermeture Forza di chiusura	25 – 30 g	25 – 30 g	25 – 30 g	25 – 30 g

Approximatoren, doppelbeweglich  
 Approximators, double-action  
 Aproximadores, con doble acción  
 Approximateurs, deux clips mobiles  
 Approssimatori, con doppio movimento

Anlegepinzetten  
 Applying forceps  
 Pinzas aplicadoras  
 Pincers à appliquer  
 Pinze per applicare

mit Sperre  
 with catch  
 con cremallera  
 avec crémaillère  
 con cremagliera

**56.87.45**  
 14,5 cm – 5¾"  
**Biemer**



für Biemer-Müller Approximatoren  
 for Biemer-Müller approximators  
 para aproximadores Biemer-Müller  
 pour approximateurs Biemer-Müller  
 per approssimatori Biemer-Müller

ohne Sperre  
 without catch  
 sin cremallera  
 sans crémaillère  
 senza cremagliera









**56.87.46**  
 14,5 cm – 5¾"  
**Biemer**



**Mikro-Gefäßclips, Clip-Anlegepinzetten**  
**Micro Vessel Clips, Clip Applying Forceps**  
**Micro clips vasculares, Pinzas para aplicar clips**  
**Micro clips vasculaires, Pince à appliquer les clips**  
**Micro clips vascolari, Pinze per applicare clips**



**Mehdorn**

	 	 	 	 
	<b>56.80.04</b>	<b>56.81.04</b>	<b>56.80.06</b>	<b>56.81.06</b>
Maullänge Jaw length Longitud de la boca Longueur des mors Lunghezza del morso	4 T 1,0 mm	4 T 1,4 mm	6 T 1,0 mm	6 T 1,4 mm
Öffnungsweite Opening Apertura Largeur d'ouverture Apertura	2,5 mm	5,0 mm	3,0 mm	3,0 mm
Schließkraft Closing pressure Fuerza de cierre Force de fermeture Forza di chiusura	10 – 15 g	15 – 20 g	10 – 15 g	15 – 20 g

Einzelclips  
 Single Clips  
 Clips singular  
 Climps seuls  
 Clis singolari

8

Anlegepinzetten für Mehdom Clips  
 Applying forceps for Mehdom clips  
 Pinza aplicadora para clips de Mehdom  
 Pince à appliquer les clips de Mehdom  
 Pinza per applicare le clip di Mehdom

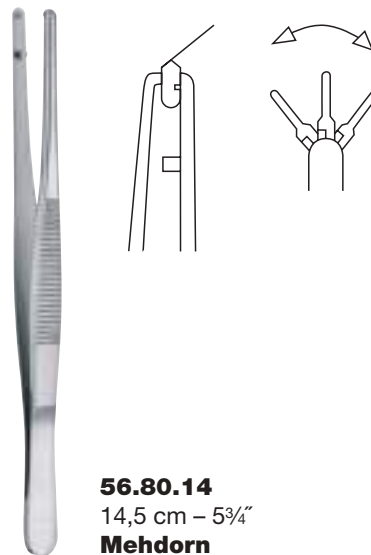

**56.80.14**  
 14,5 cm – 5¾"  
**Mehdorn**





**Gefäßclips  
Vessel Clips  
Clips vasculares  
Clips vasculaires  
Clip vascolari**

**Müller**

Gefäßclips  
Vessel clips  
Clips vasculares  
Clips vasculaires  
Clip vascolari

8

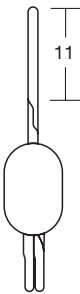
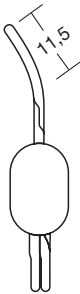
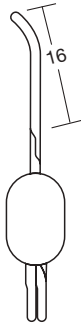
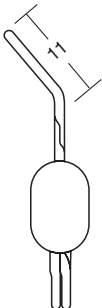
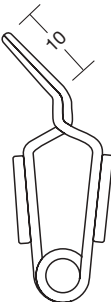
						
Schließkraft Closing pressure Fuerza de cierre Force de fermeture Forza di chiusura	<b>50 g</b>	<b>56.82.10</b>	<b>56.82.11</b>	<b>56.82.12</b>	<b>56.82.13</b>	<b>56.82.14</b>
	<b>80 g</b>	<b>56.82.20</b>	<b>56.82.21</b>	<b>56.82.22</b>	<b>56.82.23</b>	<b>56.82.24</b>

Fadenklemme, feine Kreuzriefung  
Ligature clip, fine cross-serration  
Pinza para ligadura, finas estrías en cruz  
Pince à ligature, striure cruciforme fine  
Clip per legatura, striatura a croce sottile

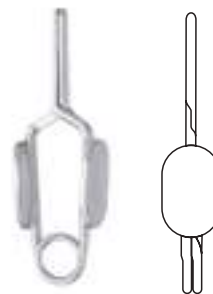





38 mm  
**56.82.25**

**Gefäßclips, Clip-Anlegezange**  
**Vessel Clips, Clip Applying Forceps**  
**Clips vasculares, Pinza aplicadora de clips**  
**Clips vasculaires, Pince à appliquer les clips**  
**Clip vascolari, Pinza per applicare le clip**



**Schwartz**

Gefäßclips  
 Vessel clips  
 Clips vasculares  
 Clips vasculaires  
 Clip vascolari

			
	<b>58.52.09</b>	<b>58.52.19</b>	<b>58.52.29</b>
Maullänge Jaw length Longitud de la boca Longueur des mors Lunghezza del morso	10 mm	10 mm	10 mm

Gefäßspreizer  
 Vessel spreader  
 Separador para vasos  
 Ecarteur pour vaisseaux  
 Divaricatore per vasi

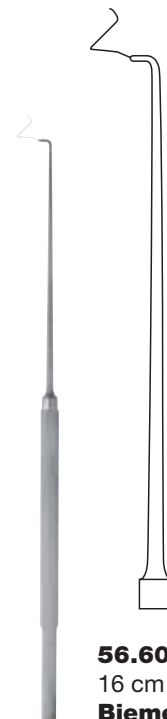

**56.60.16**  
 16 cm – 6¼"  
**Biemer**

Anlegezangen für Schwartz Gefäßclips  
 Applying forceps for Schwartz vessel clips  
 Pinza aplicadora para clips vasculares de Schwartz  
 Pince à appliquer les clips vasculaires de Schwartz  
 Pinze per applicare le clip vascolari di Schwartz



**58.52.02**  
 20 cm – 8"  
**Schwartz**

**Klemmen · Atraumatische Klemmen  
Forceps · Atraumatic Clamps  
Pinzas · Pinzas atraumáticas  
Pinces · Pinces atraumatiques  
Pinze · Pinze atraumatiche**



**Atraumatische Bulldog-Klemmen, TITAN**  
**Atraumatic Bulldog Clamps, TITANIUM**  
**Pinzas Bulldog atraumáticas, TITANIO**  
**Clamps Bulldog atraumatiques, TITANE**  
**Pinze atraumatiche Bulldog, TITANIO**

Ti

M geringes Gewicht  
 M korrosionsbeständig  
 M atraumatisch  
 M delikate Modelle  
 M differenzierte Schließkraft  
 für Vene und Arterie

M peso muy reducido  
 M resistente a la corrosión  
 M atraumáticas  
 M modelos delicados  
 M fuerza de cierre diferenciada  
 para venas y arterias

M peso minimo  
 M resistenti alla corrosione  
 M atraumatiche  
 M modelli delicati  
 M forza di chiusura differenziata  
 per vene ed arterie

M extremely light weight  
 M corrosion-resistant  
 M atraumatic  
 M delicate types  
 M different closing pressure  
 for veins and arteries

M poids réduit  
 M résistants à la corrosion  
 M atraumatiques  
 M modèles délicats  
 M forces différentes de fermeture  
 pour veines et pour artères

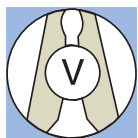

schwache Schließkraft, **für Venen**  
 soft closing pressure, **for veins**  
 fuerza de cierre baja, **para venas**  
 force de fermeture faible, **pour veines**  
 forza di chiusura débole, **per vene**

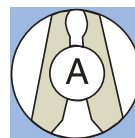

starke Schließkraft, **für Arterien**  
 strong closing pressure, **for arteries**  
 fuerza de cierre alta, **para arterias**  
 force de fermeture forte, **pour artères**  
 forza di chiusura forte, **per arterie**



3 cm – 1 1/8"

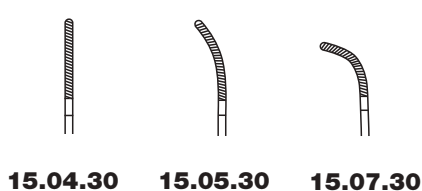

3 cm – 1 1/8"

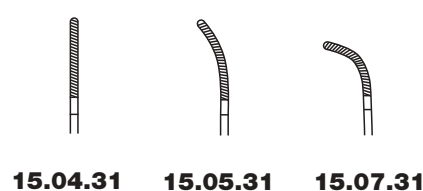

Atraumatische Bulldog-Klemmen, **TITAN**  
 Atraumatic Bulldog Clamps, **TITANIUM**  
 Pinzas Bulldog atraumáticas, **TITANIO**  
 Clamps Bulldog atraumatiques, **TITANE**  
 Pinze atraumatiche Bulldog, **TITANIO**



Ti



15.04.35



15.05.35



15.07.35

3,5 cm – 1<sup>3</sup>/<sub>8</sub>"



15.04.36



15.05.36



15.07.36

3,5 cm – 1<sup>3</sup>/<sub>8</sub>"



15.04.40



15.05.40



15.07.40

4 cm – 1<sup>1</sup>/<sub>2</sub>"



15.04.41



15.05.41



15.07.41

4 cm – 1<sup>1</sup>/<sub>2</sub>"



15.04.50



15.05.50

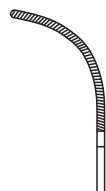

15.07.50

5 cm – 2"



15.04.51



15.05.51



15.07.51

5 cm – 2"



**Bulldog-Klemmen**  
**Bulldog Clamps**  
**Pinzas Bulldog**  
**Clamps Bulldog**  
**Pinze Bulldog**

9



**Diethrich**



**15.10.08**  
 4,5 cm – 1<sup>3</sup>/<sub>4</sub>"

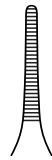

**15.10.12**  
 5 cm – 2"

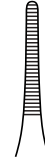

**15.10.16**  
 5,5 cm – 2<sup>1</sup>/<sub>8</sub>"

Gewicht: 3 g  
 Weight: 3 g  
 Peso: 3 g  
 Poids: 3 g  
 Peso: 3 g

Schließdruck: 50 g  
 Closing pressure: 50 g  
 Presión de cierre: 50 g  
 Force de fermeture: 50 g  
 Pressione di chiusura: 50 g



**Diethrich**



**15.11.08**  
 4,5 cm – 1<sup>3</sup>/<sub>4</sub>"

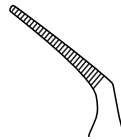

**15.11.12**  
 5 cm – 2"

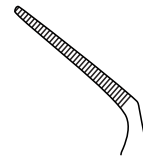

**15.11.16**  
 5,5 cm – 2<sup>1</sup>/<sub>8</sub>"



**15.10.38**  
 3,8 cm – 1½"

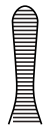

**15.10.51**  
 5,1 cm – 2"

**Dieffenbach**



**15.11.38**  
 3,8 cm – 1½"



**15.11.51**  
 5,1 cm – 2"

**Dieffenbach**



**15.12.35**  
 3,5 cm – 1¾"



**15.12.55**  
 5,5 cm – 2¼"

**Dieffenbach**



**15.13.35**  
 3,5 cm – 1¾"



**15.13.55**  
 5,5 cm – 2¼"

**Dieffenbach**



**Bulldog-Klemmen**  
**Bulldog Clamps**  
**Pinzas Bulldog**  
**Clamps Bulldog**  
**Pinze Bulldog**

9



**15.15.38**  
3,8 cm – 1½"

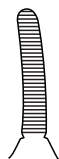

**15.15.51**  
5,1 cm – 2"



**15.15.57**  
5,7 cm – 2¼"



**15.15.63**  
6,3 cm – 2½"

**Johns-Hopkins**

**Johns-Hopkins**



**15.15.70**  
7 cm – 2¾"



**15.15.76**  
7,6 cm – 3"



**15.15.89**  
8,9 cm – 3½"  
**Johns-Hopkins**



**Johns-Hopkins**



**Atraumatische Bulldog-Klemmen**  
**Atraumatic Bulldog Clamps**  
**Pinzas Bulldog atraumáticas**  
**Clamps Bulldog atraumatiques**  
**Pinze atraumatiche Bulldog**



“AT” =  
 atraumatische Riefung  
 atraumatic serration  
 estriás atraumáticas  
 striure atraumatique  
 striatura atraumatica

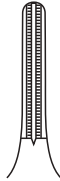

- 15.16.07** 7,5 cm – 3"
- 15.16.08** 8,5 cm – 3<sup>3</sup>/<sub>8</sub>"
- 15.16.10** 10,5 cm – 4<sup>1</sup>/<sub>8</sub>"
- 15.16.12** 12,0 cm – 4<sup>3</sup>/<sub>4</sub>"

**DeBakey “AT”**

Anlegezange für Johns-Hopkins und DeBakey Bulldogklemmen

Applying forceps for Johns-Hopkins and DeBakey Bulldog clamps

Pinza para poner los clamps Bulldog según Johns-Hopkins y DeBakey

Pince à appliquer les clamps Bulldog de Johns-Hopkins et de DeBakey

Pinza per applicare le pinze Bulldog di Johns-Hopkins e di DeBakey

9

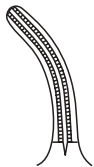
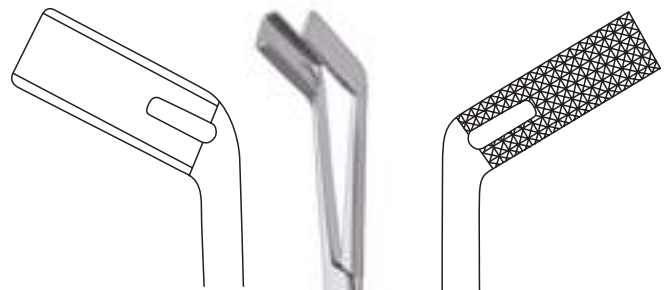

- 15.17.07** 7,0 cm – 2<sup>3</sup>/<sub>4</sub>"
- 15.17.08** 8,0 cm – 3<sup>1</sup>/<sub>8</sub>"
- 15.17.10** 10,0 cm – 4"
- 15.17.12** 11,5 cm – 4<sup>1</sup>/<sub>2</sub>"

**DeBakey “AT”**



**15.19.93**  
 24,5 cm – 9<sup>3</sup>/<sub>4</sub>"  
**Johns-Hopkins**



**Atraumatic Bulldog-Klemmen**  
**Atraumatic Bulldog Clamps**  
**Pinzas Bulldog atraumáticas**  
**Clamps Bulldog atraumatiques**  
**Pinze atraumatiche Bulldog**

"AT" =  
 atraumatiche Riefung  
 atraumatic serration  
 estrías atraumáticas  
 striure atraumatique  
 striatura atraumatica

9

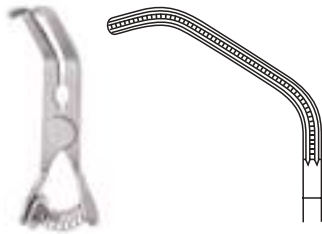

**15.19.58**  
 6 cm – 2<sup>3</sup>/<sub>8</sub>"  
**DeBakey**



**15.19.59**  
 11,5 cm – 4<sup>1</sup>/<sub>2</sub>"  
**DeBakey**

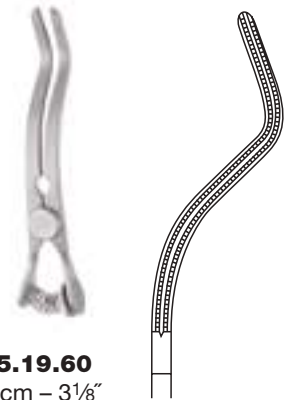

**15.19.60**  
 8 cm – 3<sup>1</sup>/<sub>8</sub>"  
**DeBakey**



**15.18.07** 7 cm – 2<sup>3</sup>/<sub>4</sub>"  
**15.18.08** 8 cm – 3<sup>1</sup>/<sub>8</sub>"  
**15.18.09** 9 cm – 3<sup>1</sup>/<sub>2</sub>"  
**15.18.11** 11 cm – 4<sup>3</sup>/<sub>8</sub>"  
**Glover "AT"**



**15.19.07** 6,5 cm – 2<sup>1</sup>/<sub>2</sub>"  
**15.19.08** 7,5 cm – 3"  
**15.19.09** 8,5 cm – 3<sup>3</sup>/<sub>8</sub>"  
**15.19.11** 10,5 cm – 4<sup>1</sup>/<sub>8</sub>"  
**Glover "AT"**



**15.19.55**  
 5 cm – 2"  
**Glover "AT"**



**Atraumatische Bulldog-Klemmen**  
**Atraumatic Bulldog Clamps**  
**Pinzas Bulldog atraumáticas**  
**Clamps Bulldog atraumatiques**  
**Pinze atraumatiche Bulldog**

"AT" =  
 atraumatische Riefung  
 atraumatic serration  
 estrías atraumáticas  
 striure atraumatique  
 striatura atraumatica

9



**Gregory**

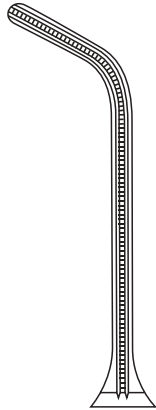

**15.15.91**  
 11 cm – 4<sup>3</sup>/<sub>8</sub>"

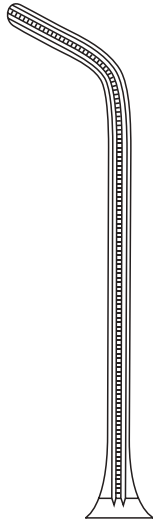

**15.15.92**  
 12 cm – 4<sup>3</sup>/<sub>4</sub>"



11 cm – 4<sup>3</sup>/<sub>8</sub>"  
**Gregory**

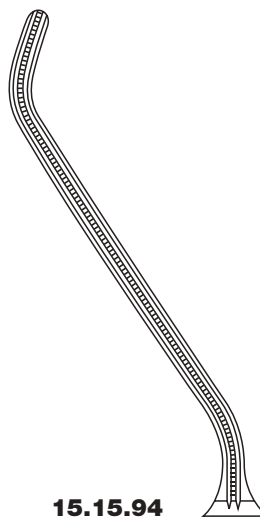

**15.15.94**

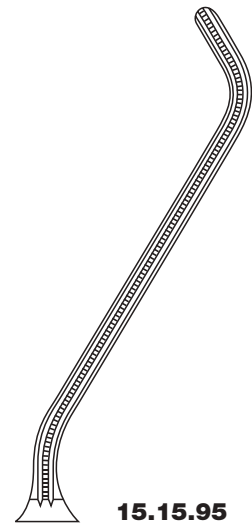

**15.15.95**



**Arterienklemmen**  
**Hemostatic Forceps**  
**Pinzas hemostáticas**  
**Pinces hémostatiques**  
**Pinze emostatiche**

9

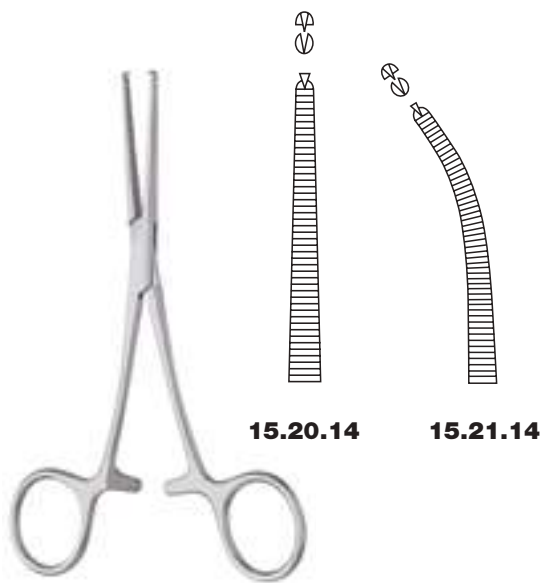

15.20.14

15.21.14

14 cm – 5½”  
**Kocher-Baby**

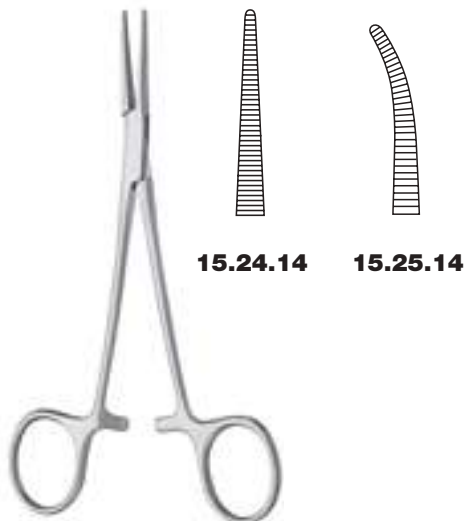

15.24.14

15.25.14

14 cm – 5½”  
**Crile-Baby**

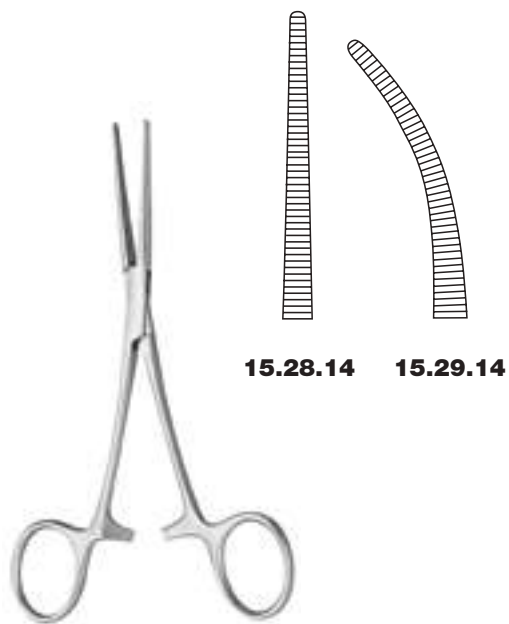

15.28.14

15.29.14

14 cm – 5½”  
**Pean-Baby**

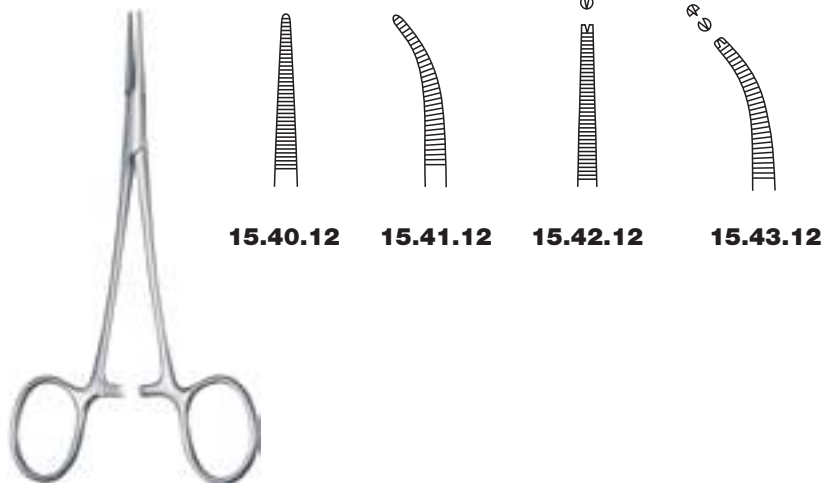

15.40.12

15.41.12

15.42.12

15.43.12

12,5 cm – 5”  
**Micro-Halsted**

**Arterienklemmen**  
**Hemostatic Forceps**  
**Pinzas hemostáticas**  
**Pinces hémostatiques**  
**Pinze emostatiche**



9

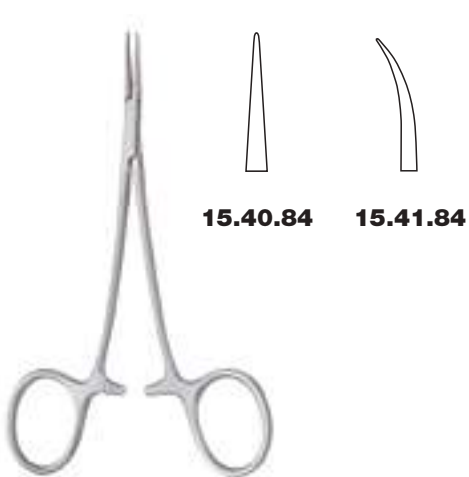

**15.40.84**    **15.41.84**

12,5 cm – 5"  
**Micro-Jacobson**  
**(Koshima)**



**15.44.42**    **15.45.42**

12,5 cm – 5"  
**Mosquito "AT"**

"AT" =  
  
 atraumatic serration  
 estrias atraumáticas  
 striure atraumatique  
 striatura atraumatica

M superfeine Modelle  
 M höchste Präzision  
 M geringes Gewicht

M modelos super finos  
 M máxima precisión  
 M peso mínimo

M modelli molto delicati  
 M alta precisione  
 M leggero

M ultra delicate models  
 M highest precision  
 M light weight

M modèles superfins  
 M précision maximum  
 M poids réduit

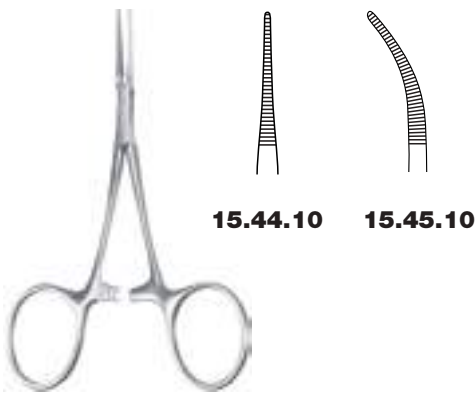

**15.44.10**    **15.45.10**

10 cm – 4"  
**"ultra"**



**15.44.22**    **15.45.22**

12,5 cm – 5"  
**"ultra"**



**Arterienklemmen**  
**Hemostatic Forceps**  
**Pinzas hemostáticas**  
**Pinces hémostatiques**  
**Pinze emostatiche**

Ti

9

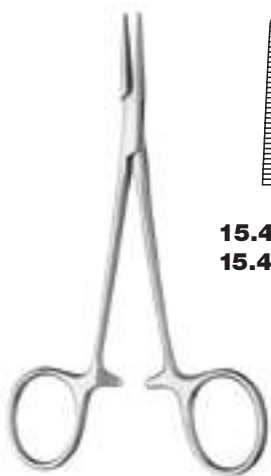

**15.44.12**  
**15.44.32\***



**15.45.12**  
**15.45.32\***

\* Titan  
 Titanium  
 Titanio  
 Titane  
 Titanio

12,5 cm – 5"  
**Halsted-Mosquito**



**15.46.12**  
**15.46.32\***



**15.47.12**  
**15.47.32\***

\* Titan  
 Titanium  
 Titanio  
 Titane  
 Titanio

12,5 cm – 5"  
**Halsted-Mosquito**



**15.44.14**



**15.45.14**

14 cm – 5½"  
**Halsted-Mosquito**



**15.44.82**



**15.45.82**

12,5 cm – 5"  
**Medicon-Packer (Skillman)**



Ti

9



15.56.15



15.57.15

15 cm – 6"  
**Leriche**



15.58.15

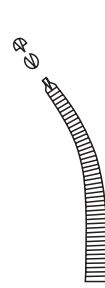

15.59.15

15 cm – 6"  
**Leriche**

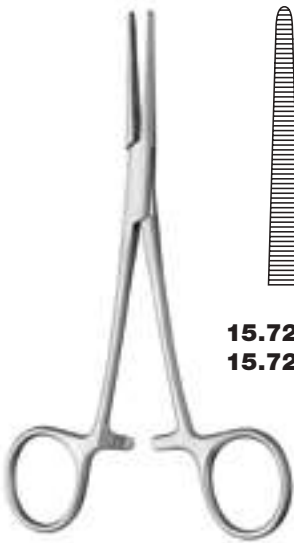

15.72.14  
 15.72.34\*



15.73.14  
 15.73.34\*

\* Titan  
 Titanium  
 Titanio  
 Titane  
 Titanio

14 cm – 5½"  
**Crile**



15.72.64  
 15.72.74\*



15.73.64  
 15.73.74\*

\* Titan  
 Titanium  
 Titanio  
 Titane  
 Titanio

14 cm – 5½"  
**Crile**



**Arterienklemmen**  
**Hemostatic Forceps**  
**Pinzas hemostáticas**  
**Pinces hémostatiques**  
**Pinze emostatiche**

“AT” =  
 atraumatische Riefung  
 atraumatic serration  
 estrías atraumáticas  
 striure atraumatique  
 striatura atraumatica

9

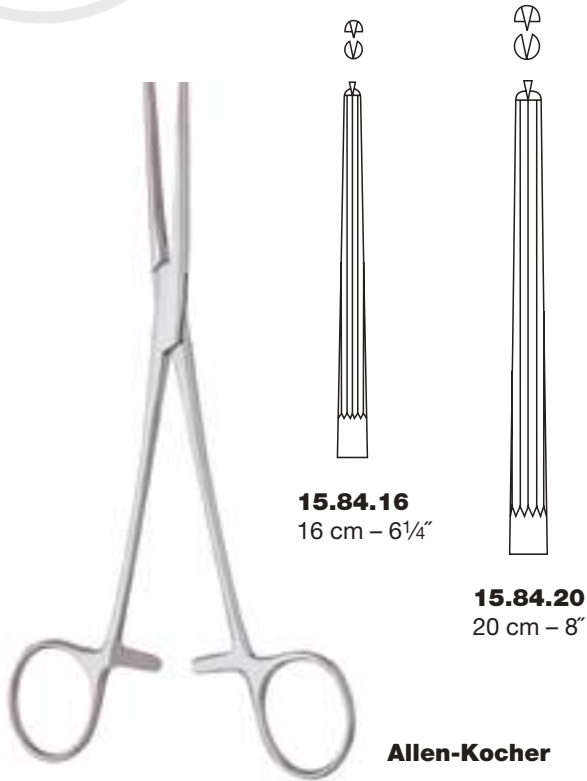



Arterienklemmen  
 Hemostatic Forceps  
 Pinzas hemostáticas  
 Pinces hémostatiques  
 Pinze emostatiche



9



**Pean**



**16.10.13**  
 13 cm – 5 1/8"



**16.10.14**  
 14 cm – 5 1/2"



**16.11.13**  
 13 cm – 5 1/8"



**16.11.14**  
 14 cm – 5 1/2"



**16.12.85**  
 15 cm – 6"  
**Lovelace**



**Kocher**



**16.12.13**  
 13 cm – 5 1/8"

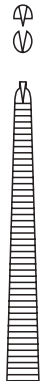

**16.12.14**  
 14 cm – 5 1/2"

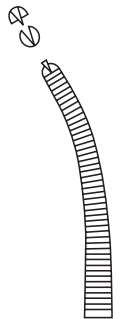

**16.13.13**  
 13 cm – 5 1/8"

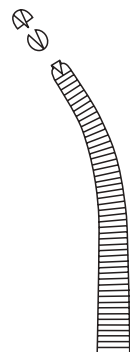

**16.13.14**  
 14 cm – 5 1/2"



**16.12.96**  
 16 cm – 6 1/4"  
**Dixon-Lovelace**





**Arterienklemmen**  
**Hemostatic Forceps**  
**Pinzas hemostáticas**  
**Pinces hémostatiques**  
**Pinze emostatiche**

9



**Rochester-Pean**



**16.10.16**  
16 cm – 6¼"



**16.10.18**  
18 cm – 7⅛"



**16.10.20**  
20 cm – 8"



**16.10.22**  
22 cm – 8¾"



**16.10.24**  
24 cm – 9½"



**16.10.26**  
26 cm – 10¼"



**Rochester-Pean**

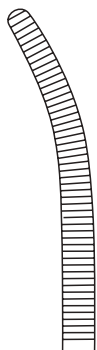

**16.11.16**  
16 cm – 6¼"

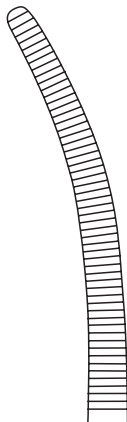

**16.11.18**  
18 cm – 7⅛"



**16.11.20**  
20 cm – 8"

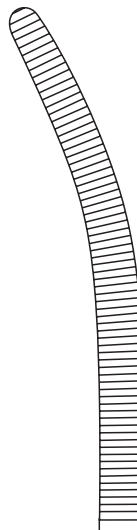

**16.11.22**  
22 cm – 8¾"

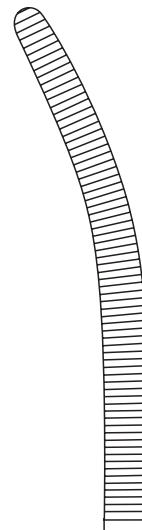

**16.11.24**  
24 cm – 9½"

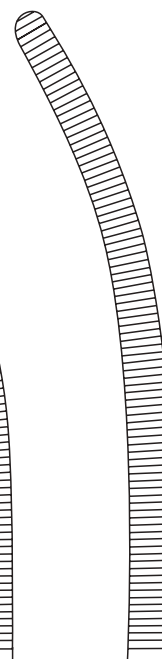

**16.11.26**  
26 cm – 10¼"



**Arterienklemmen  
Hemostatic Forceps  
Pinzas hemostáticas  
Pinces hémostatiques  
Pinze emostatiche**

9

“AT” =  
  
 atraumatische Riefung  
 atraumatic serration  
 estriás atraumáticas  
 striure atraumatique  
 striatura atraumatica



14 cm – 5½”  
**Pean “AT”**

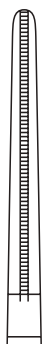

**16.10.44**

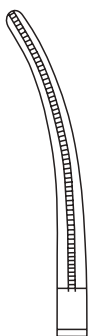

**16.11.44**

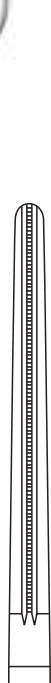

**16.10.50**  
20 cm – 8”

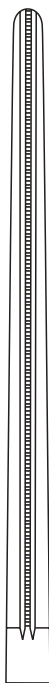

**16.10.56**  
26,5 cm – 10½”

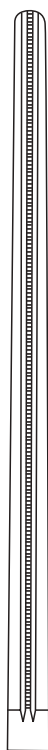

**16.10.58**  
28 cm – 11”

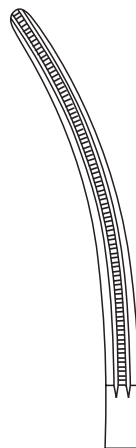

**16.11.50**  
20 cm – 8”

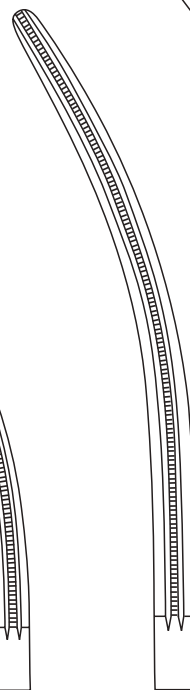

**16.11.56**  
26 cm – 10¼”

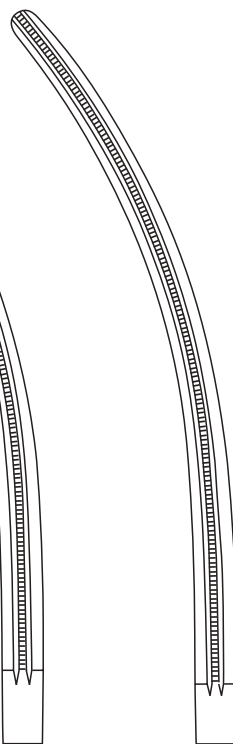

**16.11.58**  
27,5 cm – 10¾”

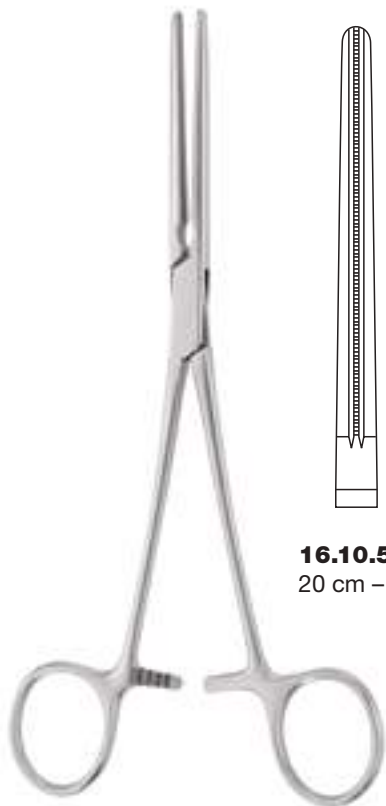

**DeBakey-Pean “AT”**



**Arterienklemmen  
 Hemostatic Forceps  
 Pinzas hemostáticas  
 Pincès hémostatiques  
 Pinze emostatiche**

9



**Rochester-Ochsner  
 Kocher**

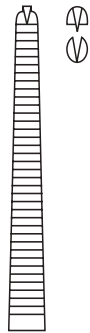

**16.12.16**  
 16 cm – 6¼"

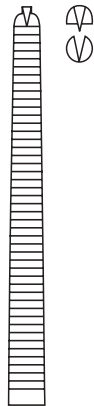

**16.12.18**  
 18 cm – 7⅛"

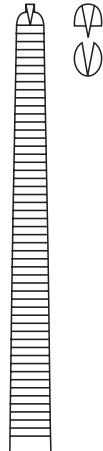

**16.12.20**  
 20 cm – 8"

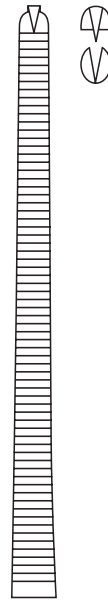

**16.12.22**  
 22 cm – 8¾"

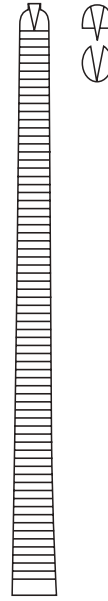

**16.12.24**  
 24 cm – 9½"

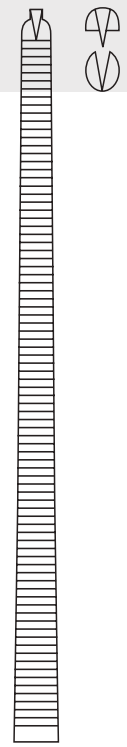

**16.12.26**  
 26 cm – 10¼"



**16.13.16**  
 16 cm – 6¼"

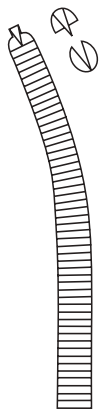

**16.13.18**  
 18 cm – 7⅛"

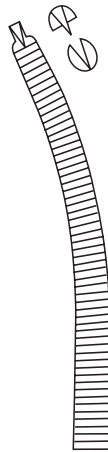

**16.13.20**  
 20 cm – 8"



**16.13.22**  
 22 cm – 8¾"



**16.13.24**  
 24 cm – 9½"



**16.13.26**  
 26 cm – 10¼"

**Arterienklemmen  
Hemostatic Forceps  
Pinzas hemostáticas  
Pincas hémostatiques  
Pinze emostatiche**



9



**16.14.74**

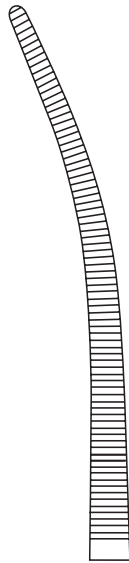

**16.15.74**

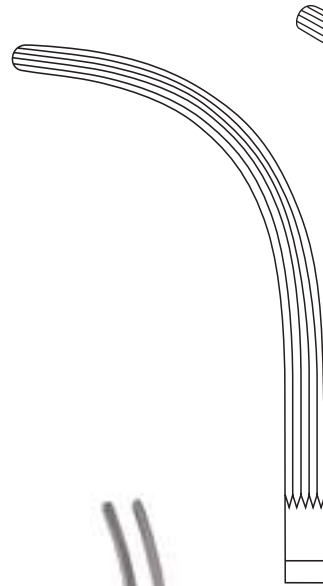

**16.15.92**

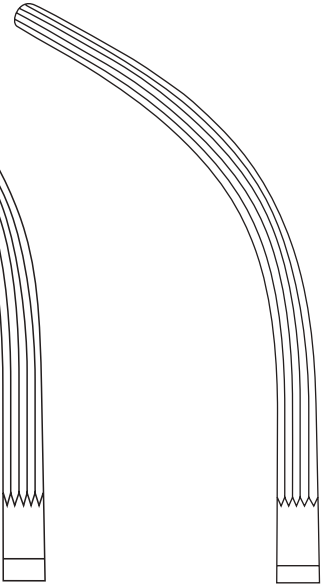

**16.15.93**



24 cm – 9½"  
**Sarot**



24 cm – 9½"  
**Crafoord-Sellors**

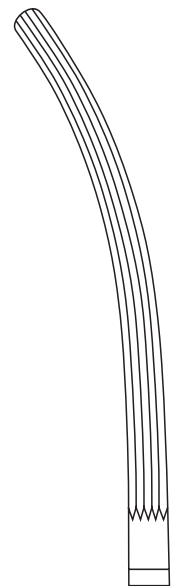

**16.15.94**



**Arterienklemmen**  
**Hemostatic Forceps**  
**Pinzas hemostáticas**  
**Pinces hémostatiques**  
**Pinze emostatiche**

9



**16.40.18**

**16.41.18**

18 cm – 7 1/8"  
**Halsted (Adson)**



**16.40.88**

**16.41.88**

**16.41.89**

18 cm – 7 1/8"  
**Jacobson-micro**

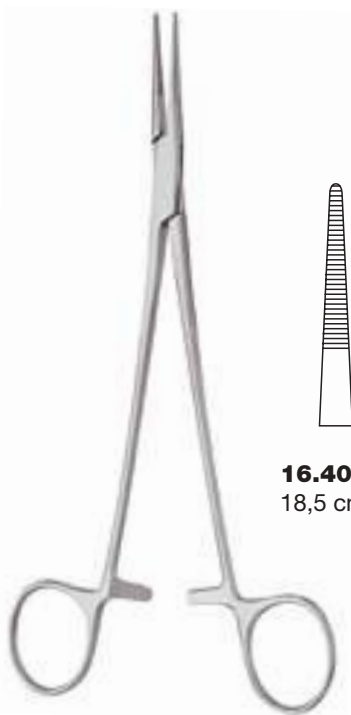

**Adson**

**16.40.19**  
 18,5 cm – 7 1/4"

**16.40.21**  
 21 cm – 8 1/4"

**16.41.19**  
 18,5 cm – 7 1/4"

**16.41.21**  
 21 cm – 8 1/4"



Arterienklemmen  
 Hemostatic Forceps  
 Pinzas hemostáticas  
 Pinces hémostatiques  
 Pinze emostatiche



9



Heiss



**16.50.20**  
 21 cm – 8¼"

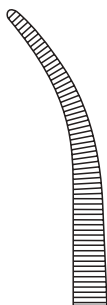

**16.51.20**  
 21 cm – 8¼"

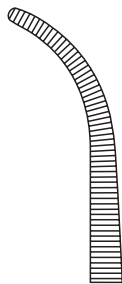

**16.51.21**  
 20 cm – 8"



**16.50.24**  
 24 cm – 9½"

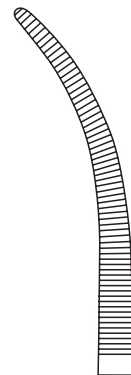

**16.51.24**  
 24 cm – 9½"

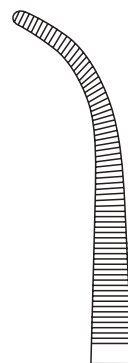

**16.51.25**  
 24 cm – 9½"



Heiss

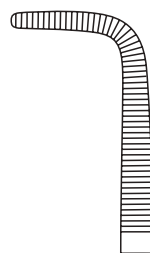

**16.51.90**  
 20 cm – 8"



**16.51.94**  
 24 cm – 9½"



**Arterienklemmen**  
**Hemostatic Forceps**  
**Pinzas hemostáticas**  
**Pinces hémostatiques**  
**Pinze emostatiche**

9

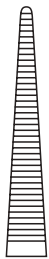

**16.50.28**



28 cm – 11"  
**Bridge**



**16.51.28**



**16.51.97**  
27 cm – 10<sup>3</sup>/<sub>4</sub>"  
**Meeker**



**Arterienklemmen  
Hemostatic Forceps  
Pinzas hemostáticas  
Pincas hémostatiques  
Pinze emostatiche**



9



**Bengolea**



**16.56.20**  
20 cm – 8"



**16.56.23**  
23 cm – 9"



**16.57.20**  
20 cm – 8"

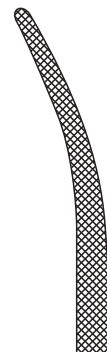

**16.57.23**  
23 cm – 9"

**16.57.26**  
26 cm – 10¼"



**Bengolea**



**16.58.20**  
20 cm – 8"



**16.58.23**  
23 cm – 9"

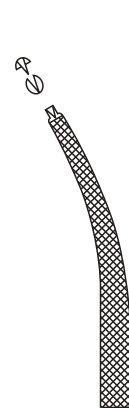

**16.59.20**  
20 cm – 8"

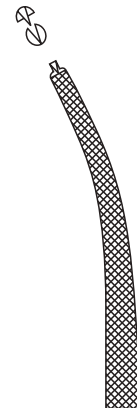

**16.59.23**  
23 cm – 9"

**16.59.26**  
26 cm – 10¼"



**Arterienklemmen**  
**Hemostatic Forceps**  
**Pinzas hemostáticas**  
**Pinces hémostatiques**  
**Pinze emostatiche**

9

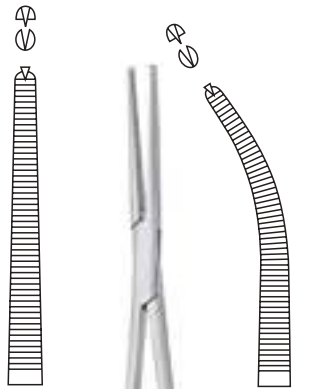

**16.52.20**

**16.53.20**



21 cm – 8¼"  
**Heiss**



**16.61.19**  
19 cm – 7½"  
**Fuchsig**

**Präparier- und Ligaturklemmen**  
**Dissecting and Ligature Forceps**  
**Pinzas para preparación y para ligaduras**  
**Pinces à préparation et à ligature**  
**Pinze per preparazione e legatura**



9



**Overholt-Geissendoerfer**

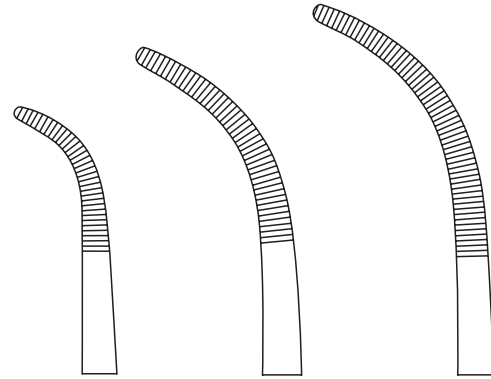

**16.65.19**  
19 cm – 7½"

**16.65.21**  
21,5 cm – 8½"

**16.65.22**  
22,5 cm – 9"

**16.65.27**  
27 cm – 10¾"

**16.65.28**  
28 cm – 11"

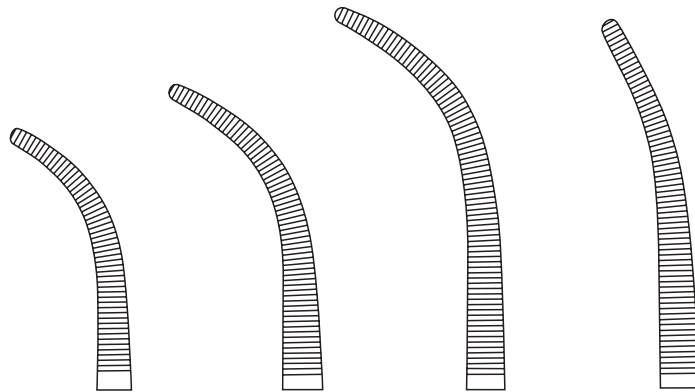

**16.65.70**  
20,5 cm – 8"

**16.65.71**  
21 cm – 8¼"

**16.65.72**  
22,5 cm – 9"

**16.65.73**  
23,5 cm – 9¼"

**16.65.76**  
26 cm – 10¼"

**16.65.77**  
27 cm – 10¾"

**16.65.78**  
27,5 cm – 10¾"



**Präparier- und Ligaturklemmen**  
**Dissecting and Ligature Forceps**  
**Pinzas para preparación y para ligaduras**  
**Pinces à préparation et à ligature**  
**Pinze per preparazione e legatura**

9

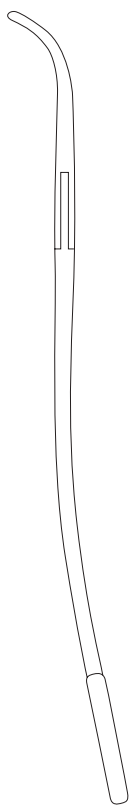

**Overholt-slim**

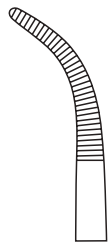

**16.64.18**  
18,5 cm – 7¼"

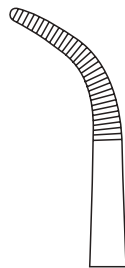

**16.64.20**  
20,5 cm – 8"

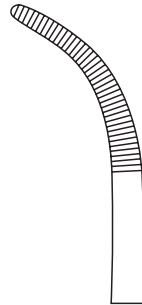

**16.64.21**  
21 cm – 8¼"

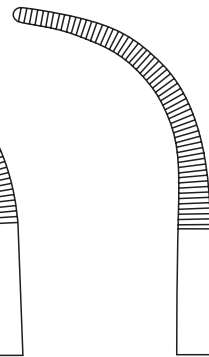

**16.64.22**  
21,5 cm – 8½"

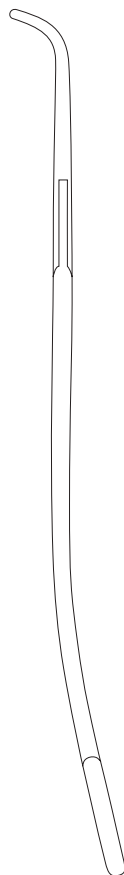

24 cm – 9½"  
**Overholt-Miotti**

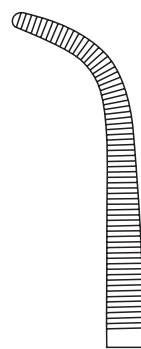

**16.66.23**

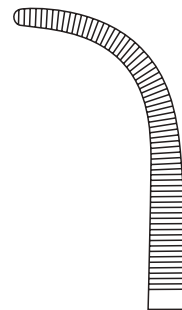

**16.66.24**

**Präparier- und Ligaturklemmen**  
**Dissecting and Ligature Forceps**  
**Pinzas para preparación y para ligaduras**  
**Pinces à préparation et à ligature**  
**Pinze per preparazione e legatura**



9



**17.05.14**  
14 cm – 5½"

**Adson-Baby**

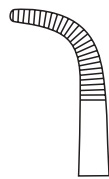

**17.05.19**  
19 cm – 7½"



**17.06.14**  
14 cm – 5½"

**Mixer-Baby**

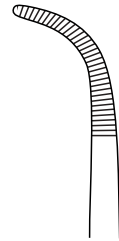

**17.06.19**  
19 cm – 7½"



**17.06.89**  
19 cm – 7½"  
**Lahey**



**17.07.18**  
18 cm – 7⅛"

**Mixer**

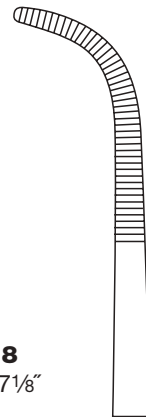

**17.07.23**  
23 cm – 9"



**Präparier- und Ligaturklemmen**  
**Dissecting and Ligature Forceps**  
**Pinzas para preparación y para ligaduras**  
**Pinces à préparation et à ligature**  
**Pinze per preparazione e legatura**

9



**17.07.50**  
20 cm – 8"  
**O'Shaughnessy**



**17.07.60**  
21 cm – 8¼"  
**Overholt-Mixer**



**17.07.70**  
20 cm – 8"  
**Wikstroem**

**Präparier- und Ligaturklemmen**  
**Dissecting and Ligature Forceps**  
**Pinzas para preparación y para ligaduras**  
**Pinces à préparation et à ligature**  
**Pinze per preparazione e legatura**



9



**Gemini**

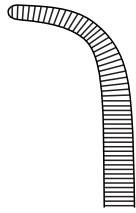

**17.08.14**  
14 cm – 5½"

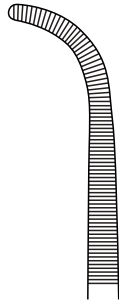

**17.08.18**  
18 cm – 7¼"

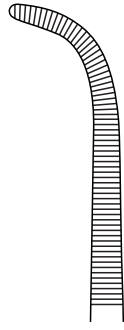

**17.08.20**  
21 cm – 8¼"



**Gemini**

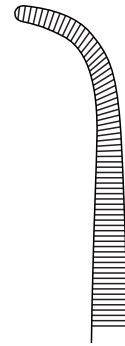

**17.08.23**  
23 cm – 9"

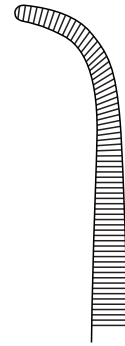

**17.08.27**  
27 cm – 10¾"



**Präparier- und Ligaturklemmen**  
**Dissecting and Ligature Forceps**  
**Pinzas para preparación y para ligaduras**  
**Pinces à préparation et à ligature**  
**Pinze per preparazione e legatura**

9



**17.07.75**  
25 cm – 10"

**17.07.77**  
27 cm – 10¼"

**Mixer-Crafoord**



**17.10.19**  
19 cm – 7½"  
**Lahey-Sweet**



**Lahey**

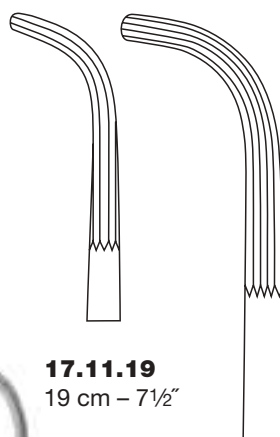

**17.11.19**  
19 cm – 7½"

**17.11.23**  
23 cm – 9"





**Mixer**

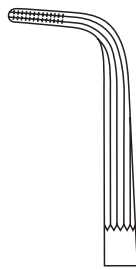

**17.12.19**  
19 cm – 7½"

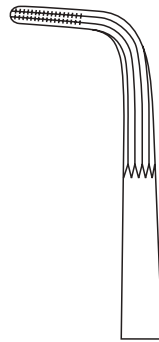

**17.12.22**  
22 cm – 8¾"

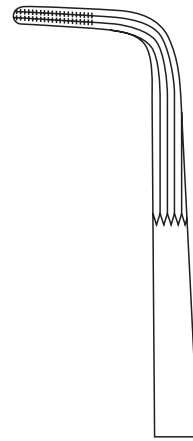

**17.12.25** 25 cm – 10"  
**17.12.27** 27 cm – 10¾"  
**17.12.29** 29 cm – 11⅜"



**Präparier- und Ligaturklemmen**  
**Dissecting and Ligature Forceps**  
**Pinzas para preparación y para ligaduras**  
**Pinces à préparation et à ligature**  
**Pinze per preparazione e legatura**

9



**54.55.23**

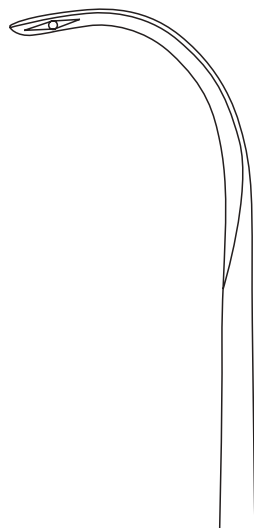

**54.55.24**

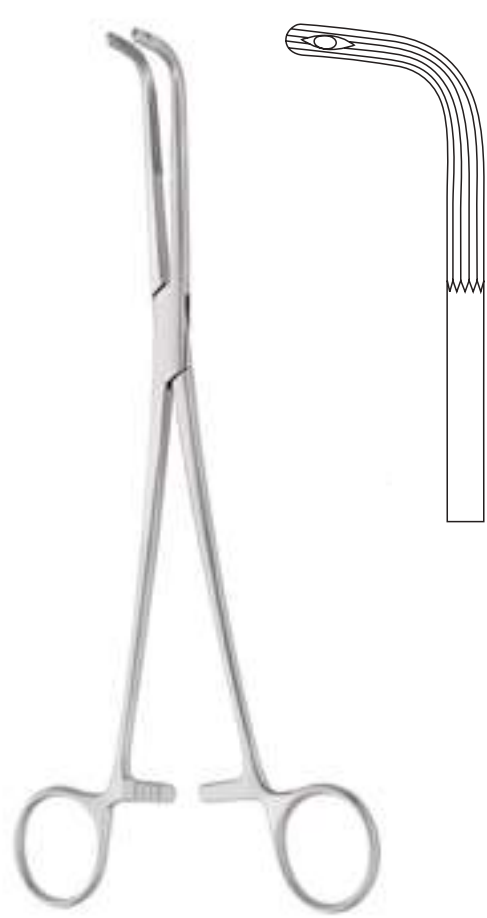

**54.55.74**  
24 cm – 9½”  
**Finochietto**

24 cm – 9½”  
**Semb**

**Bronchusklemmen  
Bronchus Clamps  
Pinzas para los bronquios  
Pinces-clamps pour bronches  
Pinze per bronchi**



9

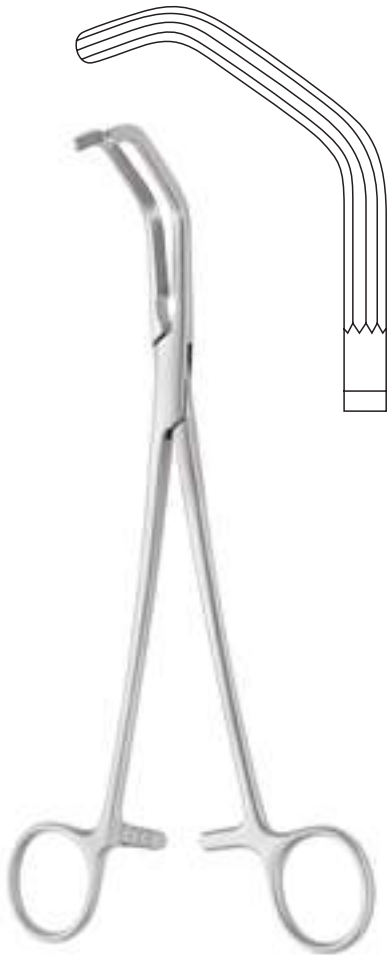

**54.57.05**  
22 cm – 8¾"  
**Price-Thomas**



**54.57.11**  
22 cm – 8¾"  
**Price-Thomas**



**54.57.12**  
22 cm – 8¾"  
**Price-Thomas**



**Bronchusklemmen**  
**Bronchus Clamps**  
**Pinzas para los bronquios**  
**Pinces-clamps pour bronches**  
**Pinze per bronchi**

9



**54.57.51**



**54.57.52**



23 cm - 9"  
**Sarot**

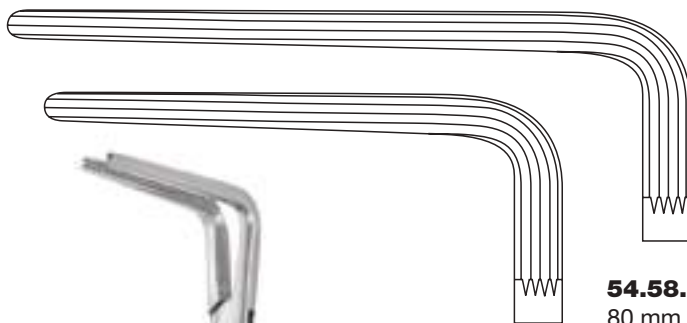

**54.58.80**  
 80 mm

**54.58.60**  
 60 mm



23 cm - 9"



**Bronchusklemmen**  
**Bronchus Clamps**  
**Pinzas para los bronquios**  
**Pinces-clamps pour bronches**  
**Pinze per bronchi**

"AT" =  
 atraumatische Riefung  
 atraumatic serration  
 estrías atraumáticas  
 striure atraumatique  
 striatura atraumatica

9

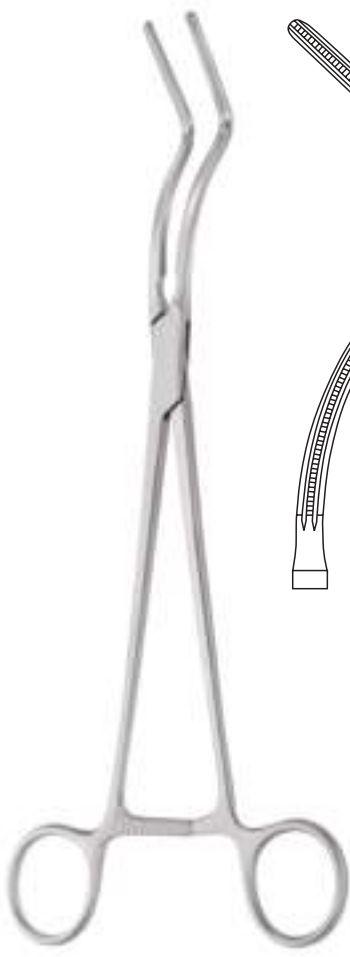

**54.59.14**  
 25 cm – 10"  
 Lees "AT"



23 cm – 9"  
 Lees "AT"

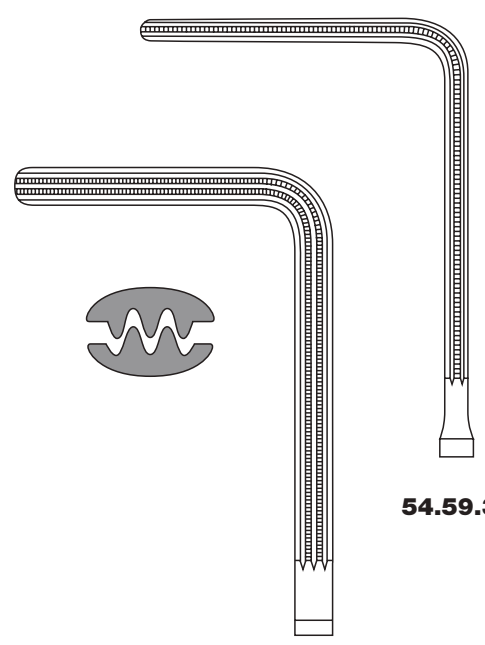

**54.59.34**

**54.59.44**



**Bronchusklemmen**  
**Bronchus Clamps**  
**Pinzas para los bronquios**  
**Pinces-clamps pour bronches**  
**Pinze per bronchi**

"AT" =  
atraumatische Riefung  
atraumatic serration  
estrias atraumáticas  
striure atraumatique  
striatura atraumatica

9



**54.59.56**  
24 cm – 9½"  
**Cooley "AT"**

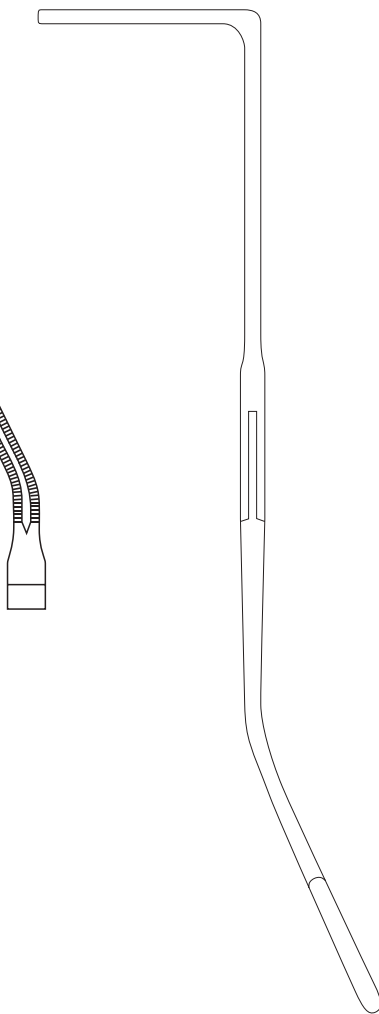

**54.59.66**  
24 cm – 9½"  
**Cooley "AT"**



**Gefäßklemmen**  
**Cardiovascular Clamps**  
**Pinzas vasculares**  
**Pinces vasculaires**  
**Pinze vascolari**

“AT” =  
 atraumatische Riefung  
 atraumatic serration  
 estriás atraumáticas  
 striure atraumatique  
 striatura atraumatica

Bulldog-Klemmen  
 Bulldog clamps  
 Pinzas Bulldog  
 Clamps Bulldog  
 Pinze Bulldog



**DeBakey “AT”**

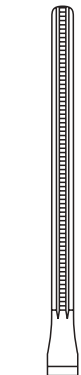

**55.30.04**  
 13 cm – 5 1/8”

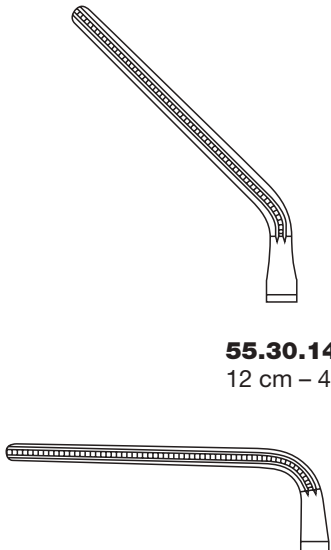

**55.30.14**  
 12 cm – 4 3/4”

**55.30.24**  
 10 cm – 4”

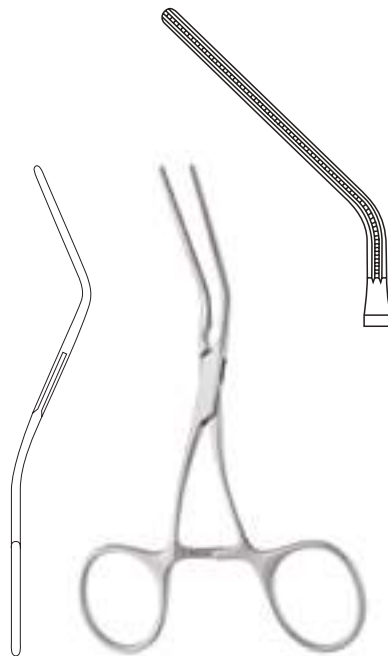

**55.30.15**  
 13 cm – 5 1/8”  
**DeBakey “AT”**

9

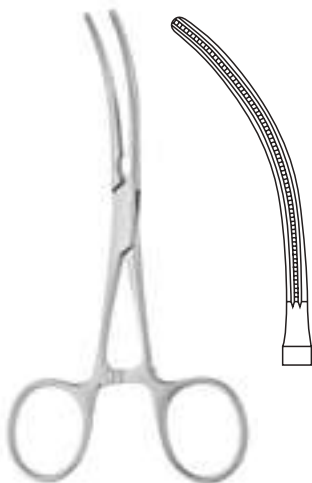

**55.30.34**  
 12 cm – 4 3/4”  
**DeBakey “AT”**

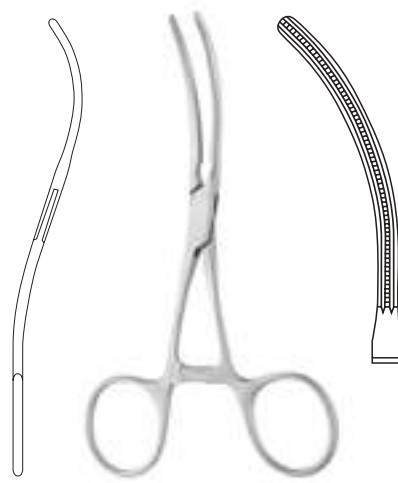

**55.30.44**  
 12 cm – 4 3/4”  
**DeBakey “AT”**





**Gefäßklemmen**  
**Cardiovascular Clamps**  
**Pinzas vasculares**  
**Pinces vasculaires**  
**Pinze vascolari**

Mehrzweckklemmen  
 Multipurpose clamps  
 Pinzas para multiples aplicaciones  
 Pinces polyvalants  
 Pinze per vari applicazione

9

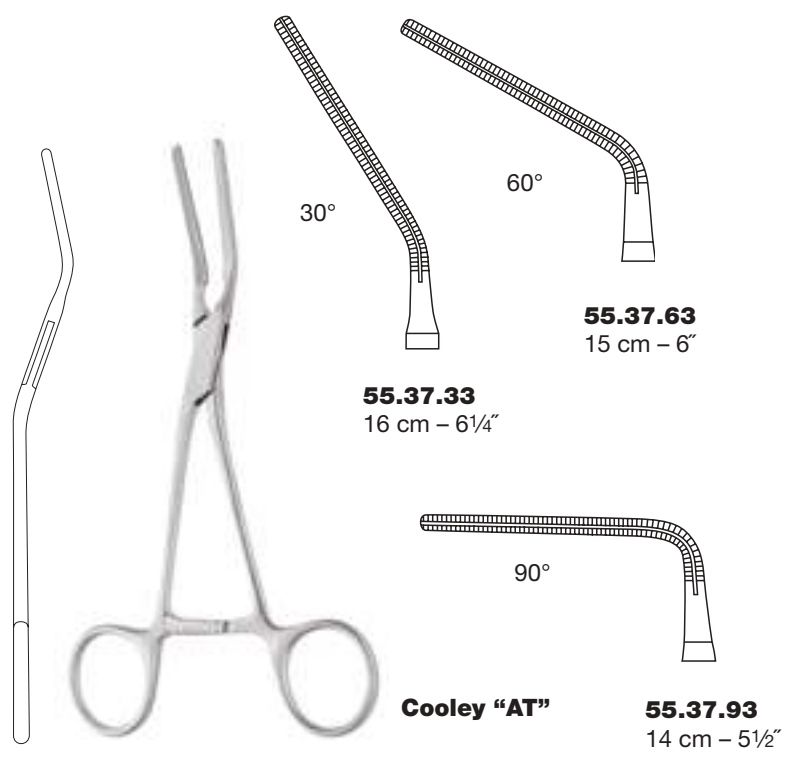
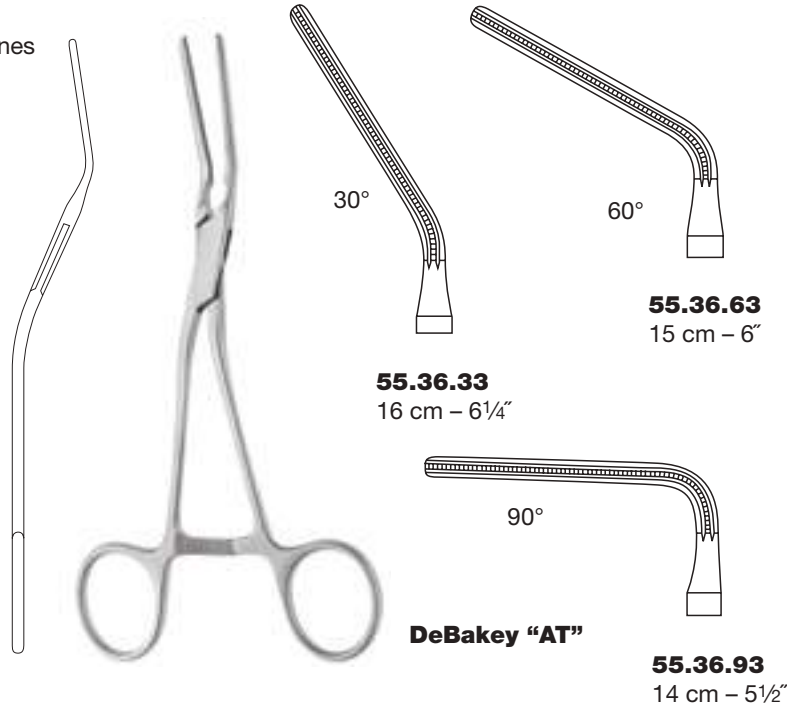
"AT" =  
  
 atraumatische Riefung  
 atraumatic serration  
 estrías atraumáticas  
 striure atraumatique  
 striatura atraumatica



"AT" =  
  
 atraumatische Riefung  
 atraumatic serration  
 estrías atraumáticas  
 striure atraumatique  
 striatura atraumatica



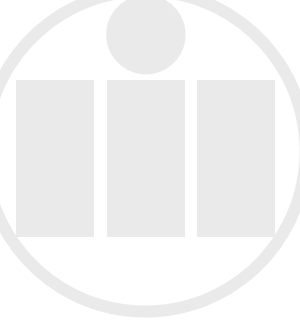

Mehrweckklemmen  
 Multipurpose clamps  
 Pinzas para multiples aplicaciones  
 Pinces polyvalants  
 Pinze per vari applicazione

"AT" =  
  
 atraumatische Riefung  
 atraumatic serration  
 estrías atraumáticas  
 striure atraumatique  
 striatura atraumatica



**55.37.95**  
 14 cm – 5½"  
**Cooley "AT"**



**55.37.83**  
 14 cm – 5½"  
**Cooley "AT"**

9



**55.37.94**  
 14 cm – 5½"

**Gregory "AT"**

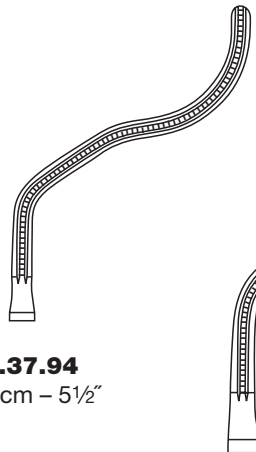

**55.37.96**  
 16 cm – 6¼"

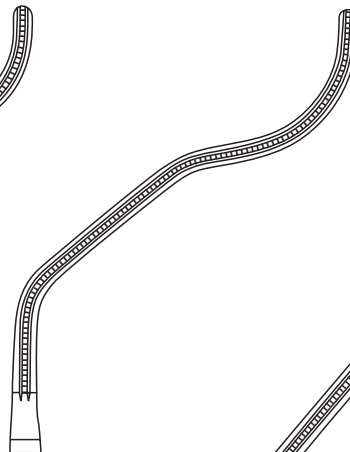

**55.37.98**  
 18 cm – 7⅛"

"AT" =  
  
 atraumatische Riefung  
 atraumatic serration  
 estrías atraumáticas  
 striure atraumatique  
 striatura atraumatica



**Gefäßklemmen**  
**Cardiovascular Clamps**  
**Pinzas vasculares**  
**Pinces vasculaires**  
**Pinze vascolari**

"AT" =  
 atraumatische Riefung  
 atraumatic serration  
 estrias atraumáticas  
 striure atraumatique  
 striatura atraumatica

Mehrzweckklemmen  
 Multipurpose clamps  
 Pinzas para multiples aplicaciones  
 Pinces polyvalants  
 Pinze per vari applicazione

9

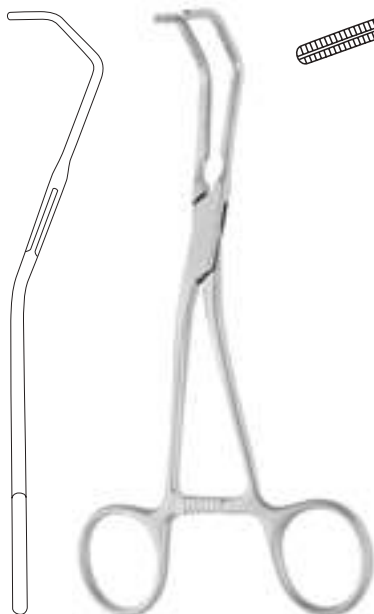

17 cm - 6<sup>3</sup>/<sub>4</sub>"  
**Cooley "AT"**

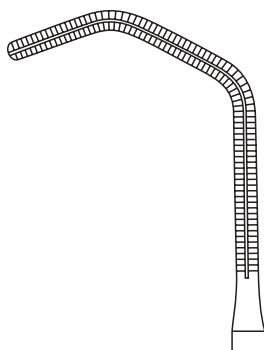

**55.39.81**

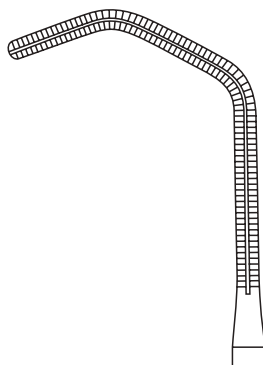

**55.39.83**

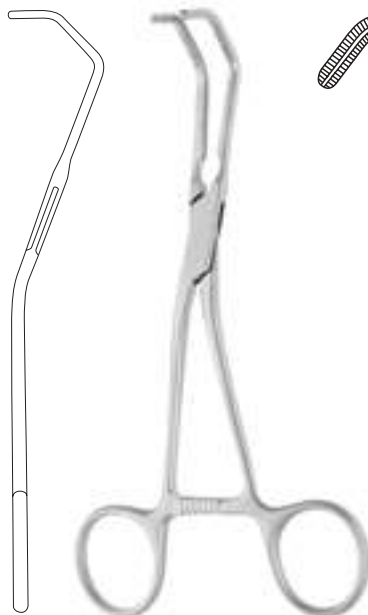

16 cm - 6<sup>1</sup>/<sub>4</sub>"  
**Cooley "AT"**

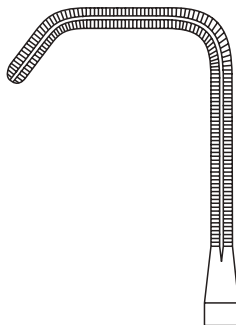

**55.39.91**

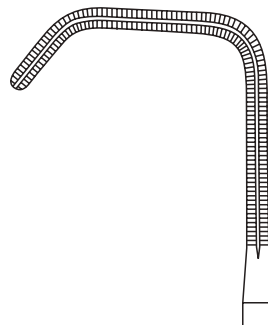

**55.39.93**

**Gefäßklemmen**  
**Cardiovascular Clamps**  
**Pinzas vasculares**  
**Pinces vasculaires**  
**Pinze vascolari**



9

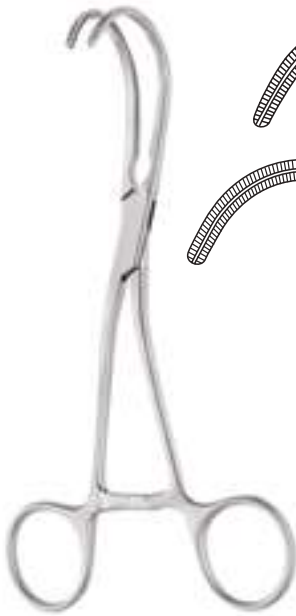

**Cooley "AT"**

**55.35.46**  
 16 cm – 6¼"

Mehrzweckklemmen  
 Multipurpose clamps  
 Pinzas para multiples aplicaciones  
 Pinces polyvalants  
 Pinze per vari applicazione

"AT" =



atraumatische Riefung  
 atraumatic serration  
 estrías atraumáticas  
 striure atraumatique  
 striatura atraumatica

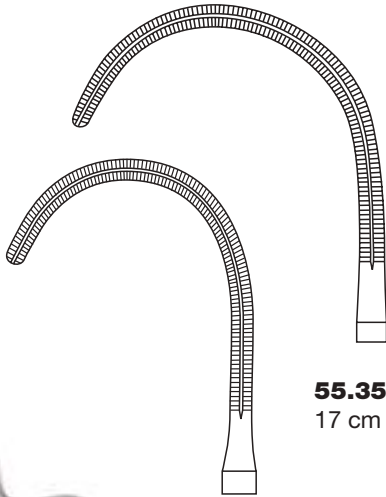

**55.35.47**  
 17 cm – 6¾"

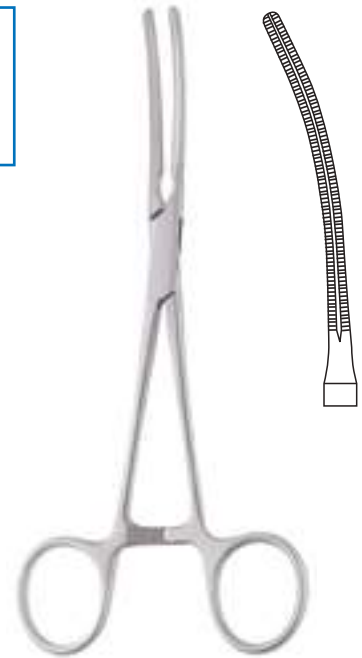

**55.35.35**  
 17 cm – 6¾"  
**Cooley-Glover "AT"**

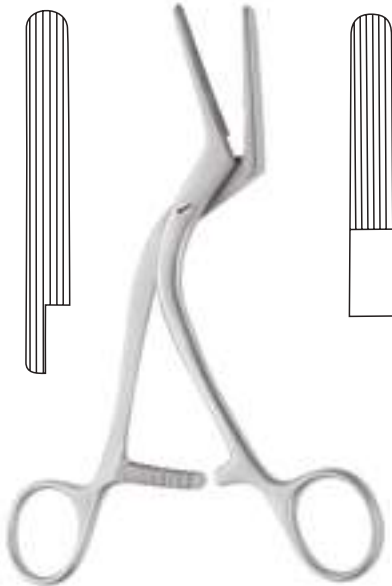

**55.22.11**  
 16 cm – 6¼"  
**Höpfner**

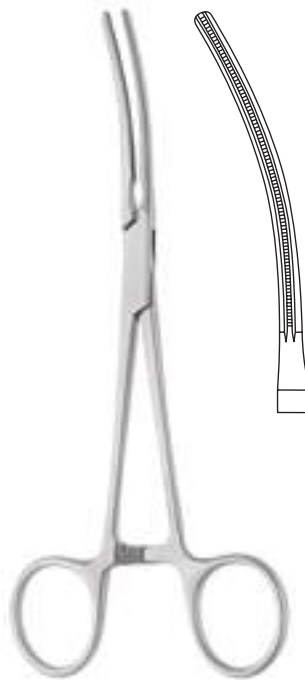

**55.34.35**  
 17 cm – 6¾"  
**DeBakey-Glover "AT"**

"AT" =



atraumatische Riefung  
 atraumatic serration  
 estrías atraumáticas  
 striure atraumatique  
 striatura atraumatica



**Gefäßklemmen**  
**Cardiovascular Clamps**  
**Pinzas vasculares**  
**Pinces vasculaires**  
**Pinze vascolari**

"AT" =  
atraumatische Riefung  
atraumatic serration  
estrias atraumáticas  
striure atraumatique  
striatura atraumatica

Mehrzweckklemmen  
Multipurpose clamps  
Pinzas para multiples aplicaciones  
Pinces polyvalants  
Pinze per vari applicazione

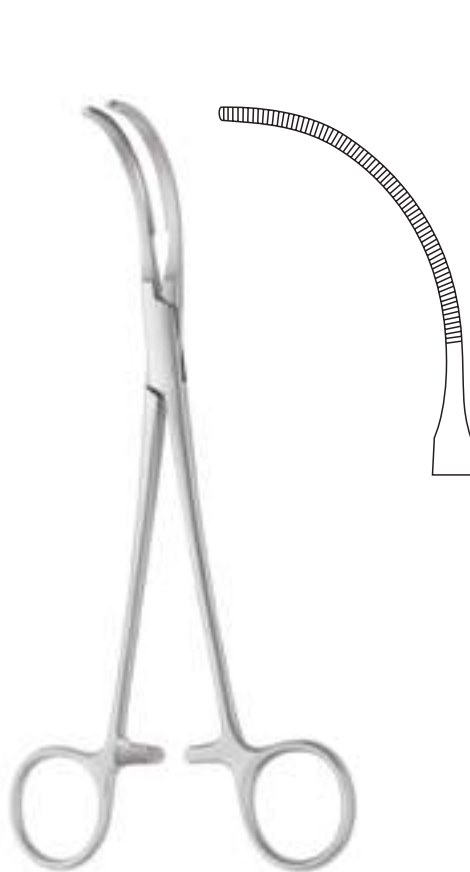

**55.25.04**  
21 cm – 8¼"  
**Potts-Glover**

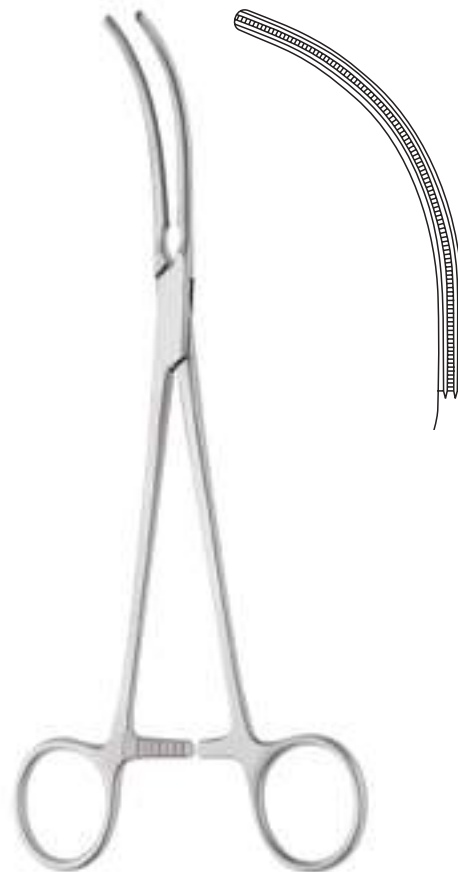

**55.44.35**  
22 cm – 8¾"  
**DeBakey-Glover "AT"**



**Gefäßklemmen**  
**Cardiovascular Clamps**  
**Pinzas vasculares**  
**Pinces vasculaires**  
**Pinze vascolari**

"AT" =  
 atraumatische Riefung  
 atraumatic serration  
 estrias atraumáticas  
 striure atraumatique  
 striatura atraumatica



**Dardik "AT"**

Mehrzweckklemmen  
 Multipurpose clamps  
 Pinzas para multiples aplicaciones  
 Pinces polyvalants  
 Pinze per vari applicazione



**55.85.00**  
 15 cm - 6"

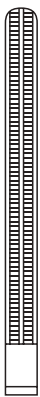

**55.86.00**  
 17 cm - 6¾"

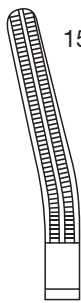

**55.85.15**  
 15 cm - 6"

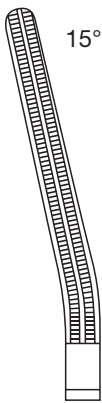

**55.86.15**  
 17 cm - 6¾"

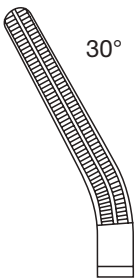

**55.85.30**  
 15 cm - 6"

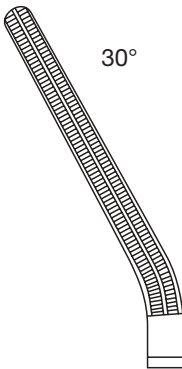

**55.86.30**  
 17 cm - 6¾"

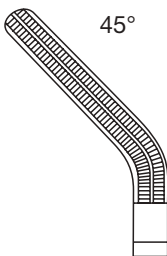

**55.85.45**  
 14,5 cm - 5¾"

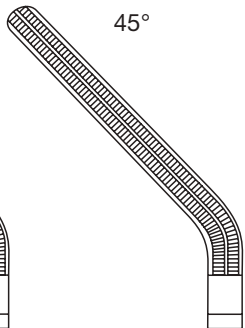

**55.86.45**  
 16 cm - 6¼"

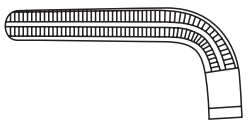

**55.85.90**  
 13 cm - 5⅛"

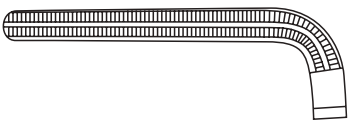

**55.86.90**  
 13,5 cm - 5¼"



**Gefäßklemmen**  
**Cardiovascular Clamps**  
**Pinzas vasculares**  
**Pinces vasculaires**  
**Pinze vascolari**

"AT" =



atraumatic Riefung  
atraumatic serration  
estrias atraumáticas  
striure atraumatique  
striatura atraumatica

Mehrweckklemmen  
Multipurpose clamps  
Pinzas para multiples aplicaciones  
Pinces polyvalents  
Pinze per vari applicazione

9

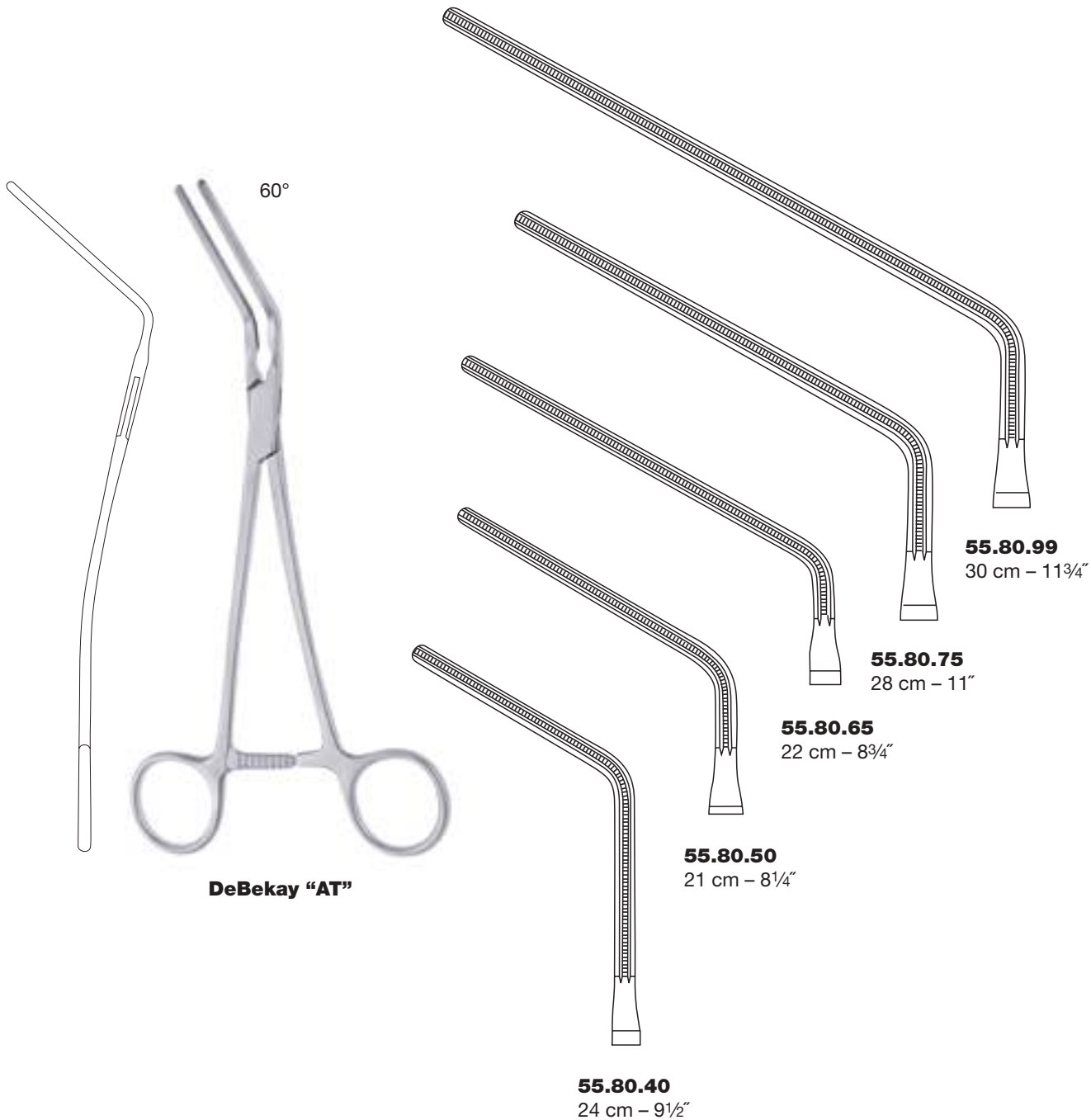



**Gefäßklemmen**  
**Cardiovascular Clamps**  
**Pinzas vasculares**  
**Pinces vasculaires**  
**Pinze vascolari**

“AT” =  
 atraumatische Riefung  
 atraumatic serration  
 estrías atraumáticas  
 striure atraumatique  
 striatura atraumatica

Mehrzweckklemmen  
 Multipurpose clamps  
 Pinzas para multiples aplicaciones  
 Pinces polyvalants  
 Pinze per vari applicazione

9

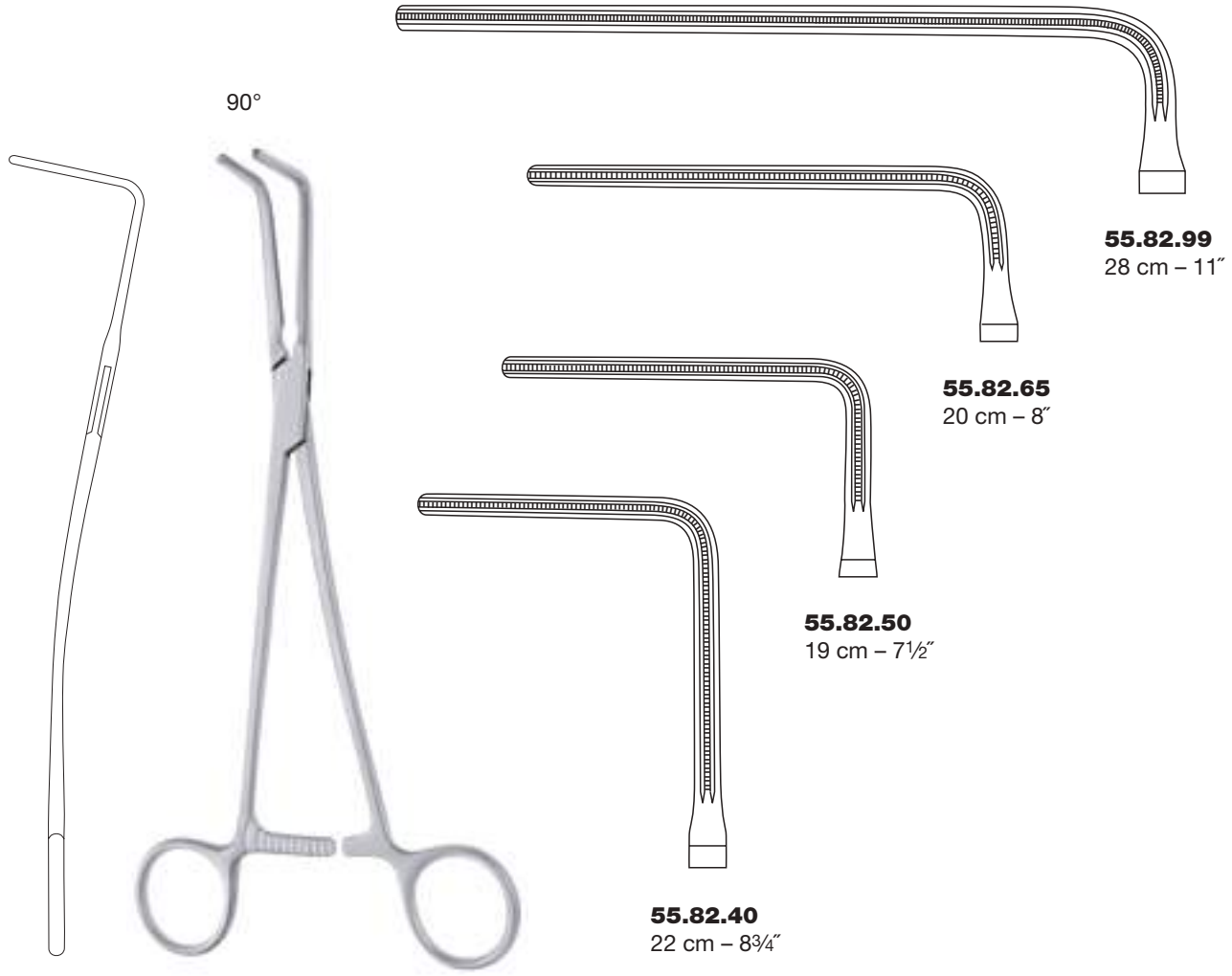

90°

**DeBakey “AT”**

**55.82.99**  
28 cm – 11”

**55.82.65**  
20 cm – 8”

**55.82.50**  
19 cm – 7½”

**55.82.40**  
22 cm – 8¾”



**Gefäßklemmen**  
**Cardiovascular Clamps**  
**Pinzas vasculares**  
**Pinces vasculaires**  
**Pinze vascolari**

"AT" =  
 atraumatic serration  
 estrías atraumáticas  
 striure atraumatique  
 striatura atraumatica

9



**Wylie "AT"**

Bauch-Aorta-Klemmen  
 Abdominal aorta clamps  
 Pinzas para aorta abdominal  
 Pinces pour l'aorte abdominale  
 Pinze per aorta addominale

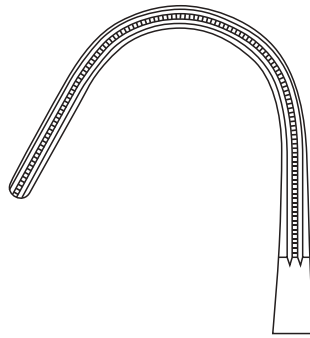

**55.83.21**  
 21 cm – 8¼"

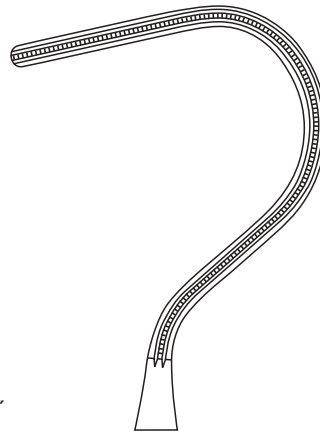

**55.83.22**  
 22 cm – 8¾"



**Wylie "AT"**

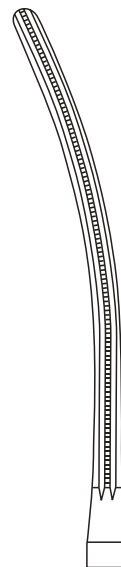

**55.83.26**  
 26 cm – 10¼"

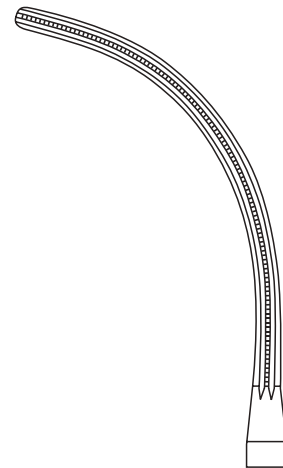

**55.83.27**  
 27 cm – 10¾"





**Gefäßklemmen**  
**Cardiovascular Clamps**  
**Pinzas vasculares**  
**Pinces vasculaires**  
**Pinze vascolari**

“AT” =  
 atraumatische Riefung  
 atraumatic serration  
 estrías atraumáticas  
 striure atraumatique  
 striatura atraumatica

Bauch-Aorta-Klemmen  
 Abdominal aorta clamps  
 Pinzas para aorta abdominal  
 Pinces pour l’aorte abdominale  
 Pinze per aorta addominale

Subklavia Arterienklemme  
 Subclavian hemostatic clamp  
 Pinza para arteria subclaviana  
 Pince pour artère subclavia  
 Pinza per arteria sottoclavicale

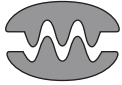

9



**Zanger “AT”**

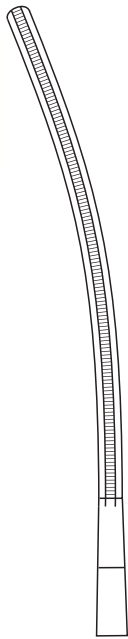

**55.83.31**  
 21,5 cm – 8½”

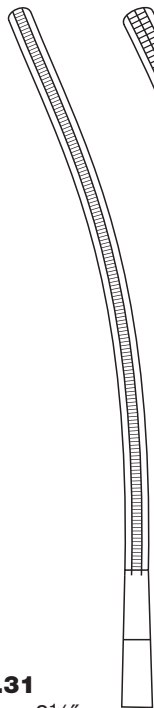

**55.83.33**  
 25 cm – 10”

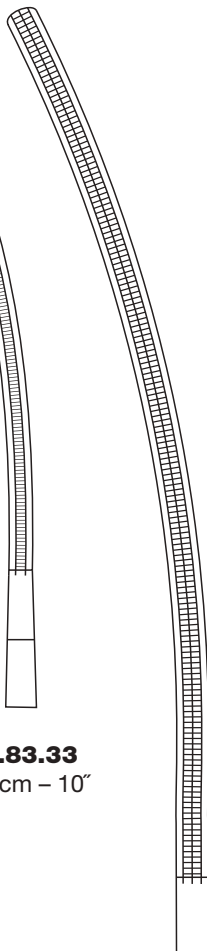

**55.83.35**  
 30,5 cm – 12”

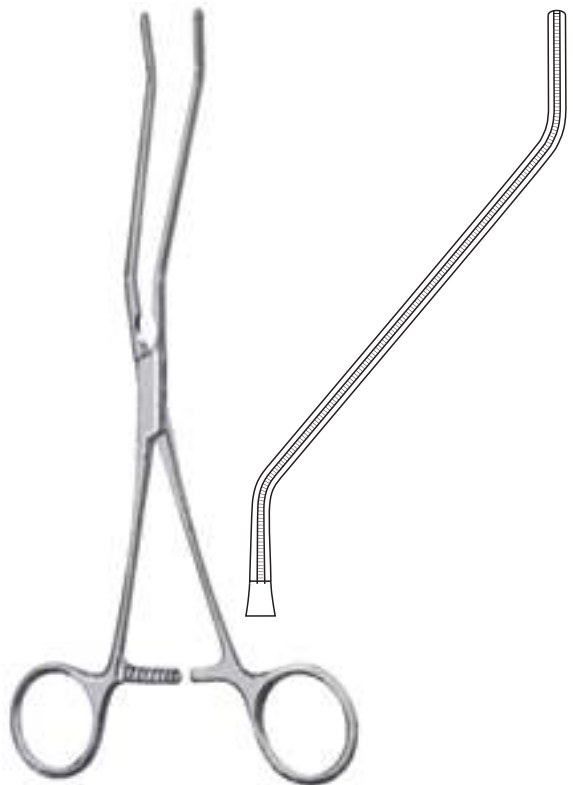

**55.83.39**  
 20 cm – 8”  
**Henly “AT”**



**Gefäßklemmen**  
**Cardiovascular Clamps**  
**Pinzas vasculares**  
**Pinces vasculaires**  
**Pinze vascolari**

"AT" =



atraumatische Riefung  
 atraumatic serration  
 estrías atraumáticas  
 striure atraumatique  
 striatura atraumatica

9

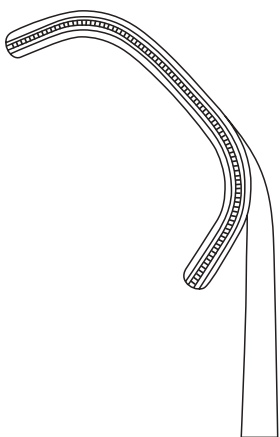
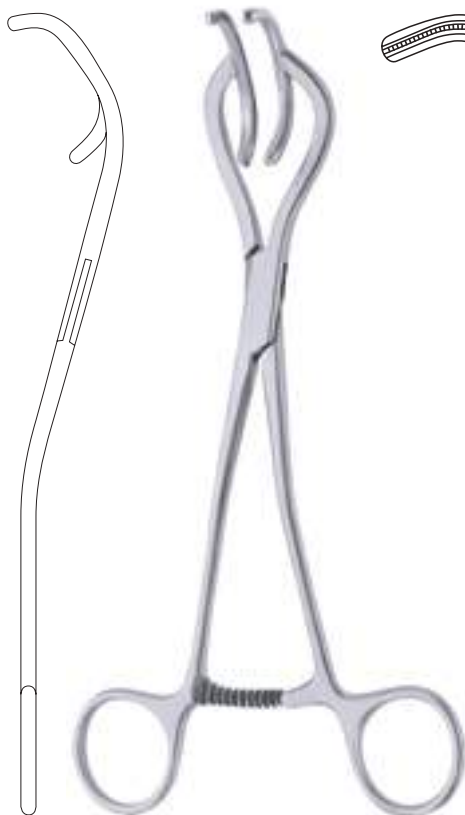

**55.35.49**  
 41 u 16 mm

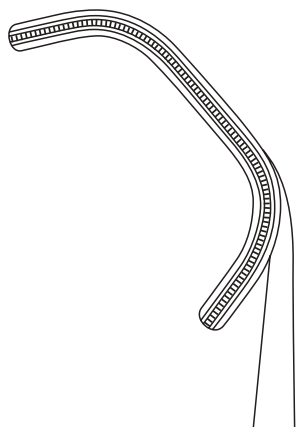

**55.35.50**  
 45 u 23 mm

Aorta-Klemmen  
 Aorta clamps  
 Pinzas para aorta  
 Pinces pour l'aorte  
 Pinze per aorta

20,5 cm – 8"  
**Lemole "AT"**

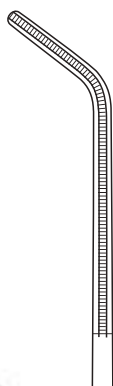
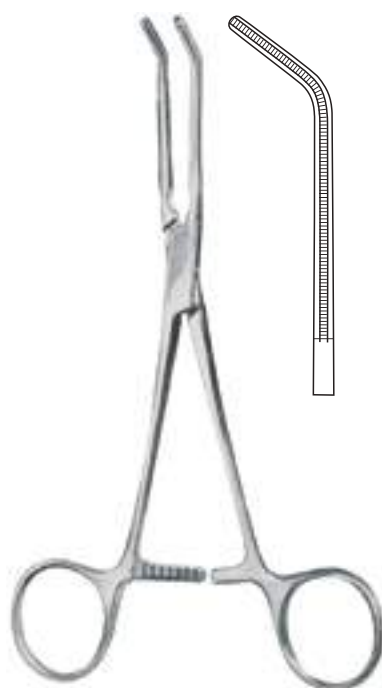

Carotisklemmen  
 Carotid clamps  
 Pinzas para carótida  
 Pinces pour carotide  
 Pinze per carotis

**55.35.52**  
 17,5 cm – 7"  
**DeBakey "AT"**  
**Husfeldt**

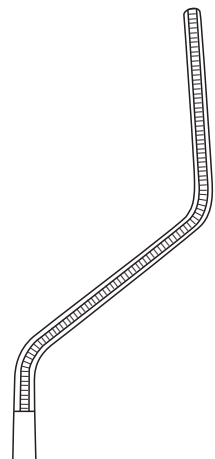
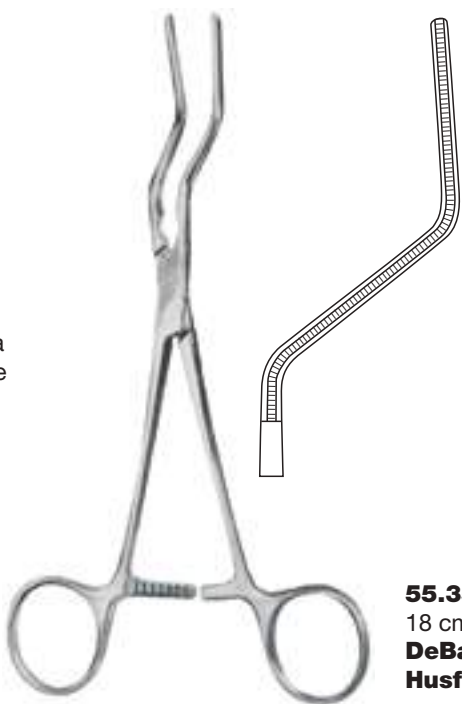

**55.35.53**  
 18 cm – 7 1/8"  
**DeBakey "AT"**  
**Husfeldt**

**Gefäßklemmen**  
**Cardiovascular Clamps**  
**Pinzas vasculares**  
**Pinces vasculaires**  
**Pinze vascolari**



Carotisklemmen  
 Carotid clamps  
 Pinzas para carótida  
 Pinces pour carotide  
 Pinze per carotis

9

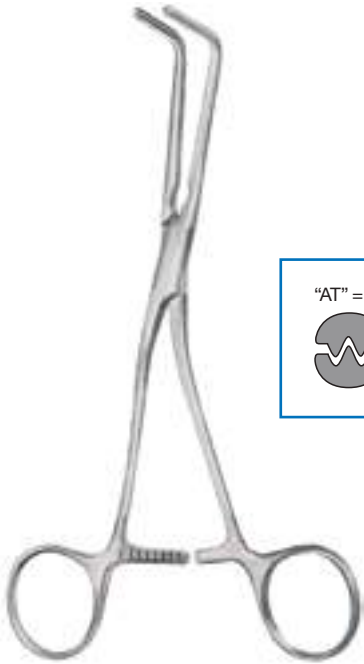

"AT" =  
  
 atraumatische Riefung  
 atraumatic serration  
 estrías atraumáticas  
 striure atraumatique  
 striatura atraumatica

**55.35.54**  
 17 cm – 6¾"  
**DeBakey "AT"**  
**Husfeldt**



**55.35.57**  
 18 cm – 7¼"  
**Javid**



**55.35.58**  
 19 cm – 7½"  
**Javid**



**Gefäßklemmen**  
**Cardiovascular Clamps**  
**Pinzas vasculares**  
**Pinces vasculaires**  
**Pinze vascolari**

"AT" =



atraumatic serration  
 estrías atraumáticas  
 striure atraumatique  
 striatura atraumatica

Tangential-Verschluss-Klemmen  
 Tangential occlusion clamps  
 Pinzas para oclusión tangencial  
 Pinces pour occlusion tangentielle  
 Pinze per occlusione tangenziale

9



**DeBakey "AT"**

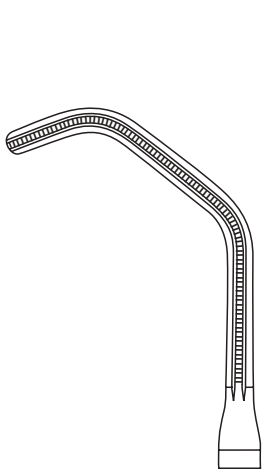

**55.70.35**  
 20 cm – 8"

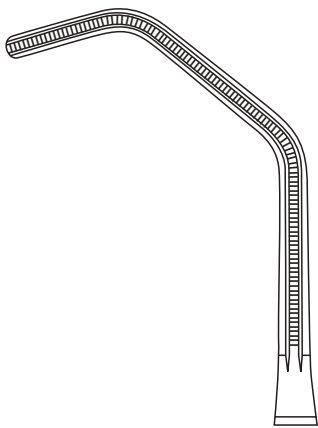

**55.70.45**  
 24,5 cm – 9¾"

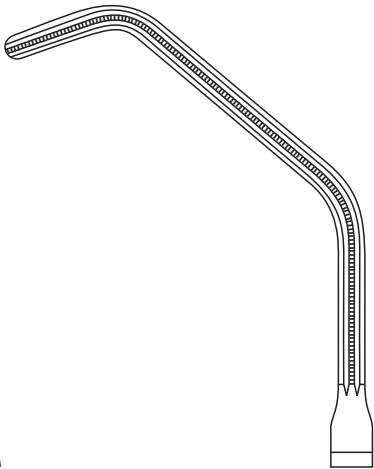

**55.70.55**  
 25,5 cm – 10"

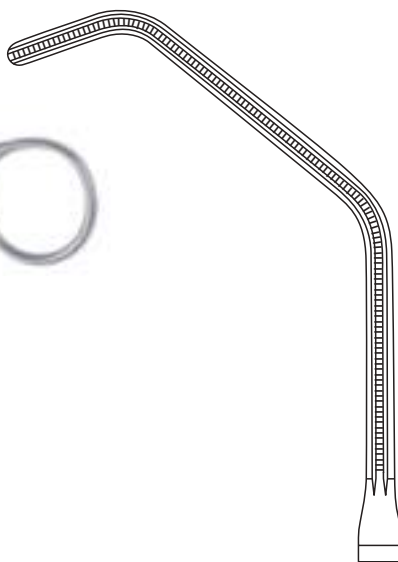

**55.70.60**  
 26,5 cm – 10½"

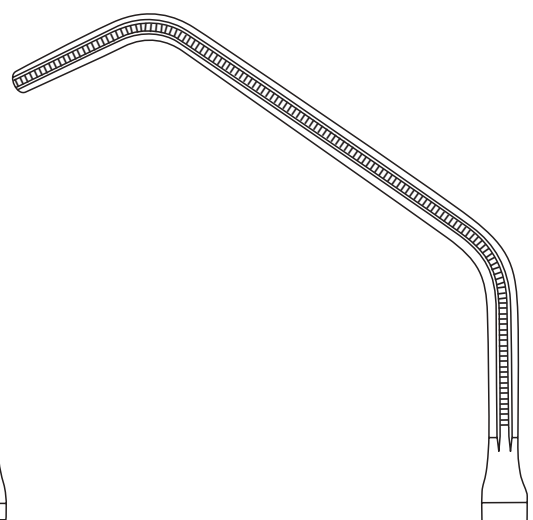

**55.70.75**  
 27,5 cm – 10¾"

**Gefäßklemmen**  
**Cardiovascular Clamps**  
**Pinzas vasculares**  
**Pinces vasculaires**  
**Pinze vascolari**



Iliac-Klemmen  
 Iliac clamps  
 Pinzas para iliaca  
 Pinces pour veine iliaque  
 Pinze per vena iliaca

Aurikel-Klemme  
 Auricle clamp  
 Pinza para aurícula  
 Pince pour oreillette  
 Pinza per auricola

"AT" =  

 atraumatische Riefung  
 atraumatic serration  
 estrías atraumáticas  
 striure atraumatique  
 striatura atraumatica

"AT" =  

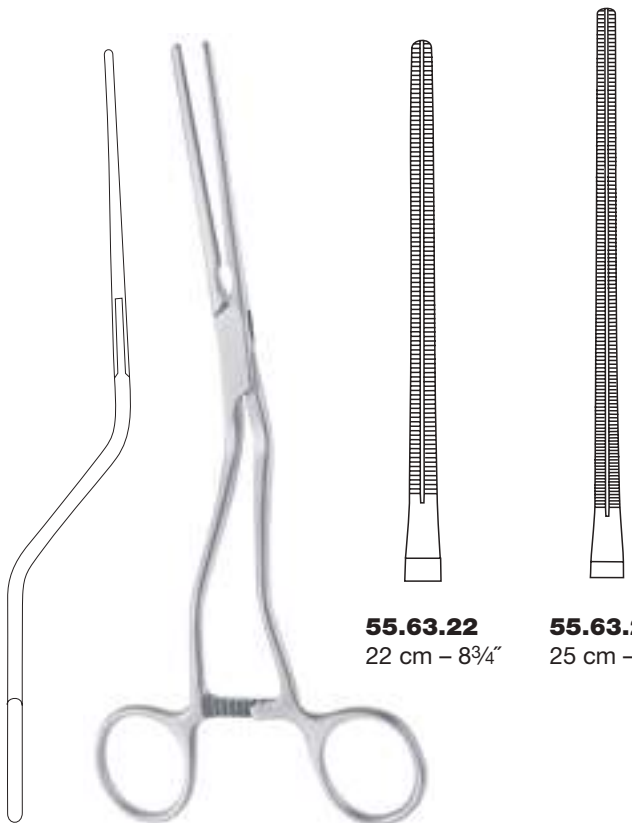
 atraumatische Riefung  
 atraumatic serration  
 estrías atraumáticas  
 striure atraumatique  
 striatura atraumatica

9



**55.63.22**  
 22 cm – 8¾"

**55.63.25**  
 25 cm – 10"

**Cooley "AT"**

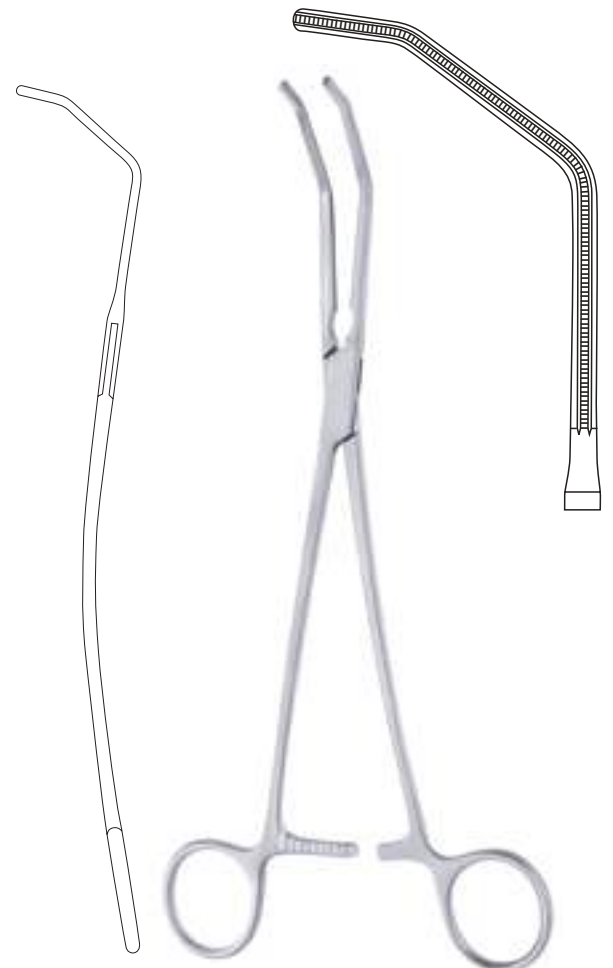

**55.74.93**  
 23 cm – 9"  
**Glover-DeBaKey "AT"**



**Gefäßklemmen**  
**Cardiovascular Clamps**  
**Pinzas vasculares**  
**Pinces vasculaires**  
**Pinze vascolari**

Patent-Ductus-Klemmen  
 Patent ductus clamps  
 Pinzas para conducto arterial  
 Pinces pour patent ductus  
 Pinze per patent ductus

"AT" =  
 atraumatische Riefung  
 atraumatic serration  
 estrias atraumáticas  
 striure atraumatique  
 striatura atraumatica

9





**Gefäßklemmen**  
**Cardiovascular Clamps**  
**Pinzas vasculares**  
**Pinces vasculaires**  
**Pinze vascolari**

"AT" =  
 atraumatische Riefung  
 atraumatic serration  
 estriás atraumáticas  
 striure atraumatique  
 striatura atraumatica



Patent-Ductus-Klemmen  
 Patent ductus clamps  
 Pinzas de conducto arterial  
 Pinces pour patent ductus  
 Pinze per patent ductus

9

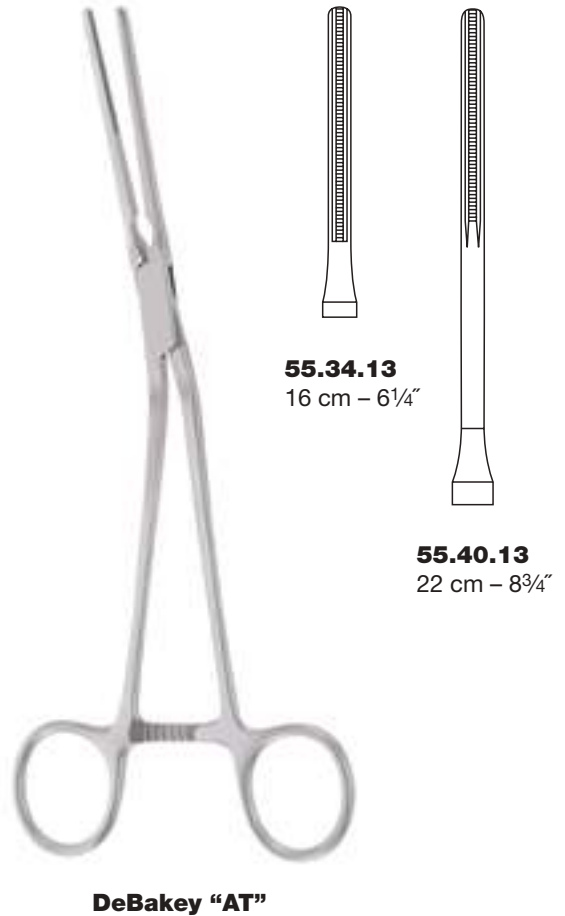
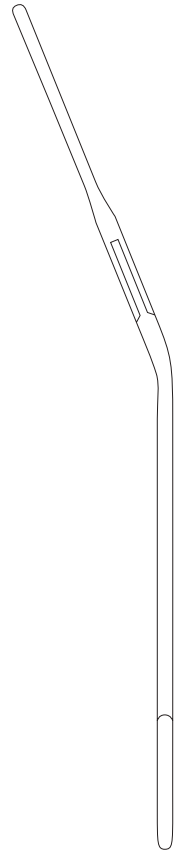



**Gefäßklemmen**  
**Cardiovascular Clamps**  
**Pinzas vasculares**  
**Pinces vasculaires**  
**Pinze vascolari**

Coarktationsklemmen  
 Coarctation clamps  
 Pinzas para coarctación  
 Pinces pour coarctation  
 Pinze per coarctazione

“AT” =  
 atraumatische Riefung  
 atraumatic serration  
 estrias atraumáticas  
 striure atraumatique  
 striatura atraumatica

9



**55.25.01**  
 22 cm – 8<sup>3</sup>/<sub>4</sub>”

**Potts**

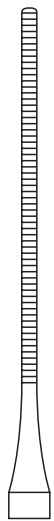

**55.25.11**  
 20 cm – 8”

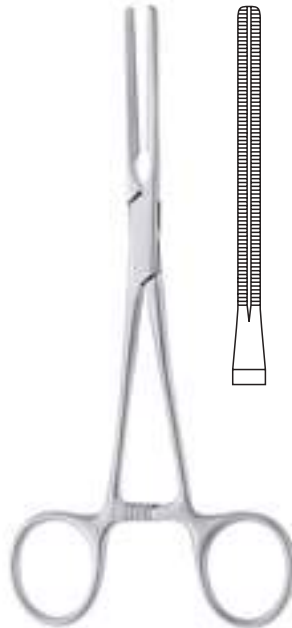

**55.35.05**  
 17 cm – 6<sup>3</sup>/<sub>4</sub>”  
**Cooley “AT”**

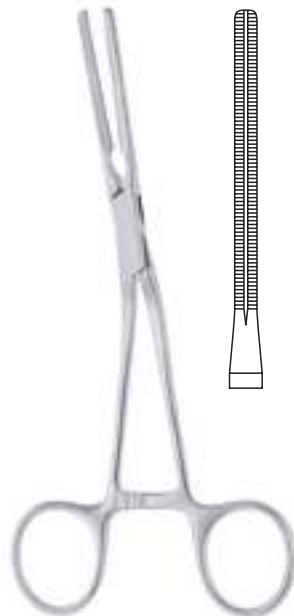

**55.35.15**  
 17 cm – 6<sup>3</sup>/<sub>4</sub>”  
**Cooley “AT”**





**Gefäßklemmen**  
**Cardiovascular Clamps**  
**Pinzas vasculares**  
**Pinces vasculaires**  
**Pinze vascolari**

"AT" =  
atraumatische Riefung  
atraumatic serration  
estrias atraumáticas  
striure atraumatique  
striatura atraumatica



**55.34.05**  
17 cm

**DeBakey "AT"**

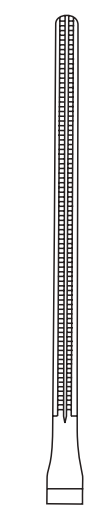

**55.40.05**  
22 cm – 8¾"



**55.34.15**  
17 cm – 6¾"

**DeBakey "AT"**

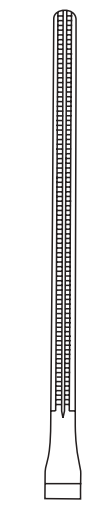

**55.40.15**  
22 cm – 8¾"

Coarktationsklemmen  
Coarctation clamps  
Pinzas para coarctación  
Pinces pour coarctation  
Pinze per coarctazione



**Gefäßklemmen**  
**Cardiovascular Clamps**  
**Pinzas vasculares**  
**Pinces vasculaires**  
**Pinze vascolari**

Anastomosenklemmen  
 Anastomosis clamps  
 Pinzas para anastomosis  
 Pinces à anastomoses  
 Pinze per anastomosi

9

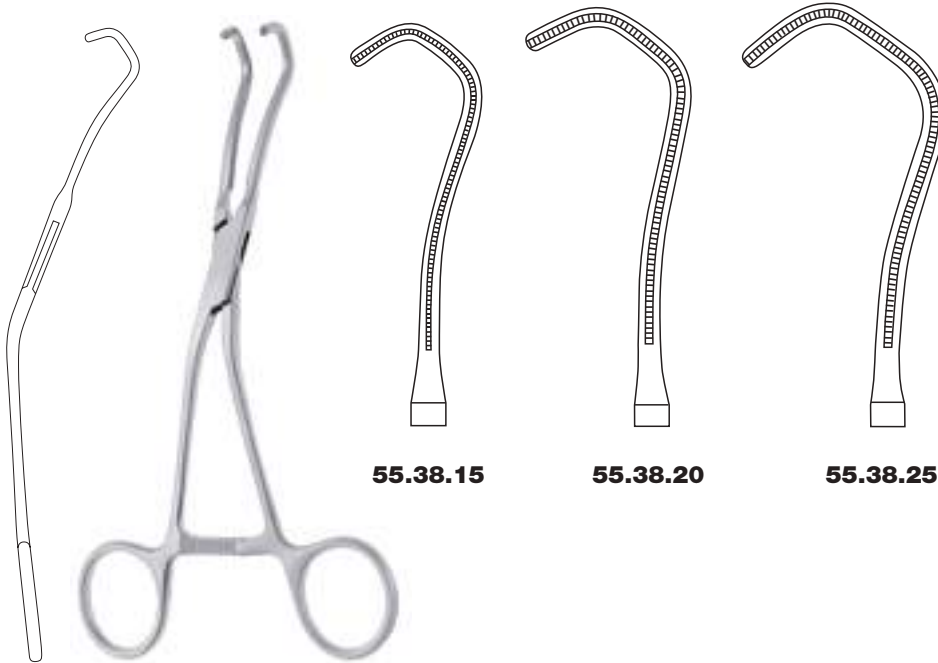

17 cm – 6<sup>3</sup>/<sub>4</sub>"

"AT" =  
  
 atraumatische Riefung  
 atraumatic serration  
 estrías atraumáticas  
 striure atraumatique  
 striatura atraumatica

**Derra-DeBakey "AT"**

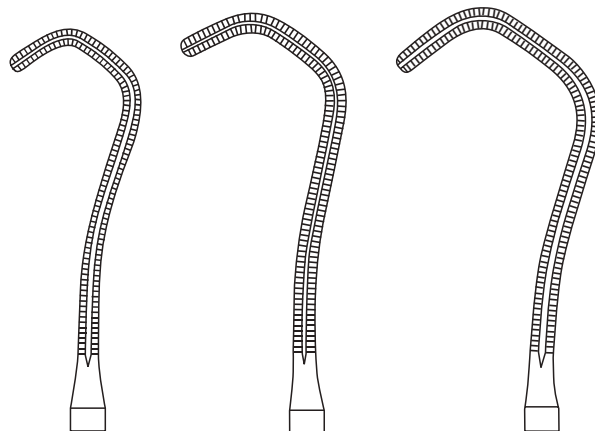

"AT" =  
  
 atraumatische Riefung  
 atraumatic serration  
 estrías atraumáticas  
 striure atraumatique  
 striatura atraumatica

**Derra-Cooley "AT"**

**Gefäßklemmen**  
**Cardiovascular Clamps**  
**Pinzas vasculares**  
**Pinces vasculaires**  
**Pinze vascolari**



“AT” =  
 atraumatische Riefung  
 atraumatic serration  
 estrías atraumáticas  
 striure atraumatique  
 striatura atraumatica



Anastomosenklemmen  
 Anastomosis clamps  
 Pinzas para anastomosis  
 Pinces à anastomoses  
 Pinze per anastomosi

9

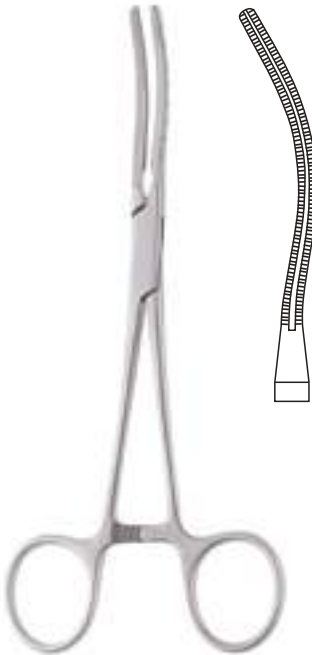

**55.35.39**  
 17 cm – 6<sup>3</sup>/<sub>4</sub>"  
**Cooley-Glover “AT”**

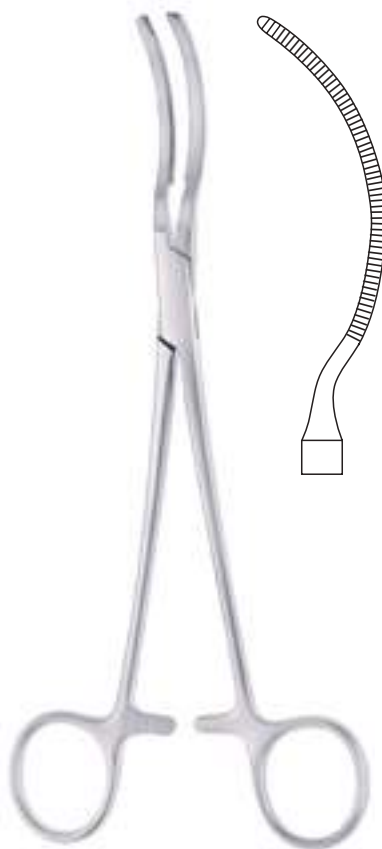

**55.25.05**  
 22 cm – 8<sup>3</sup>/<sub>4</sub>"  
**Potts-Glover**

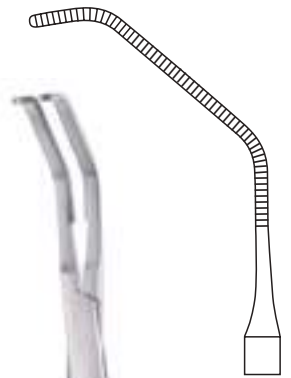

**55.25.06**  
 21 cm – 8<sup>1</sup>/<sub>4</sub>"  
**Potts-Satinsky**

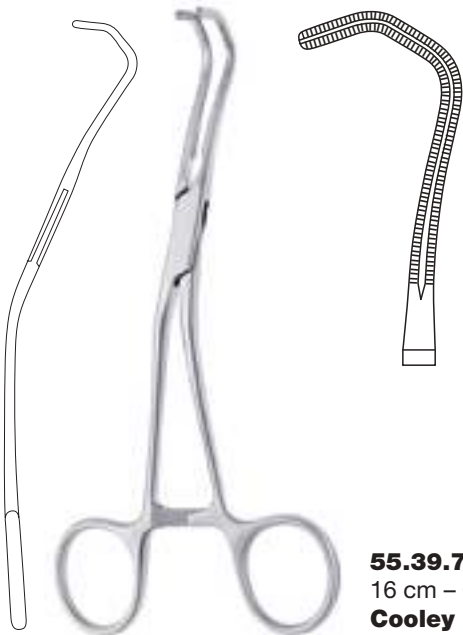

**55.39.75**  
 16 cm – 6<sup>1</sup>/<sub>4</sub>"  
**Cooley “AT”**



**Gefäßklemmen**  
**Cardiovascular Clamps**  
**Pinzas vasculares**  
**Pinces vasculaires**  
**Pinze vascolari**

“AT” =  
atraumatische Riefung  
atraumatic serration  
estrias atraumáticas  
striure atraumatique  
striatura atraumatica



Anastomosenklemmen  
Anastomosis clamps  
Pinzas para anastomosis  
Pinces à anastomoses  
Pinze per anastomosi

9

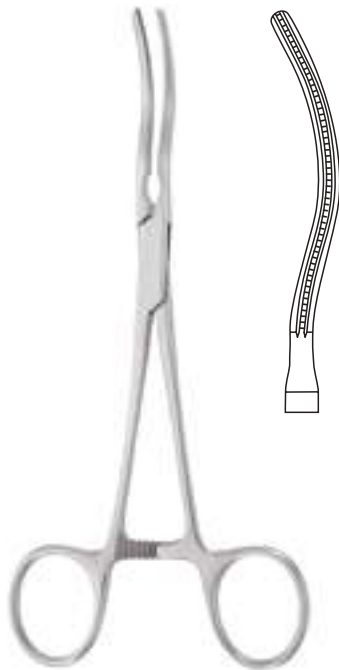

**55.34.39**  
17 cm – 6¾”  
**DeBakey-Glover “AT”**



**55.44.39**  
22 cm – 8¾”  
**DeBakey-Glover “AT”**



**Gefäßklemmen**  
**Cardiovascular Clamps**  
**Pinzas vasculares**  
**Pinces vasculaires**  
**Pinze vascolari**

“AT” =  
 atraumatische Riefung  
 atraumatic serration  
 estriás atraumáticas  
 striure atraumatique  
 striatura atraumatica

Peripheralgefäßklemmen  
 Peripheral vascular clamps  
 Pinzas para vasos periféricos  
 Pinces pour vaisseaux périphériques  
 Pinze emostatiche per vasi periferici

9



**Leland-Jones “AT”**

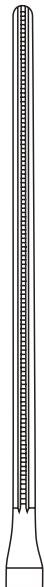

**55.50.07**  
 20 cm – 8”

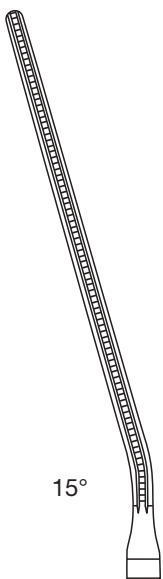

15°

**55.50.21**  
 19 cm – 7½”

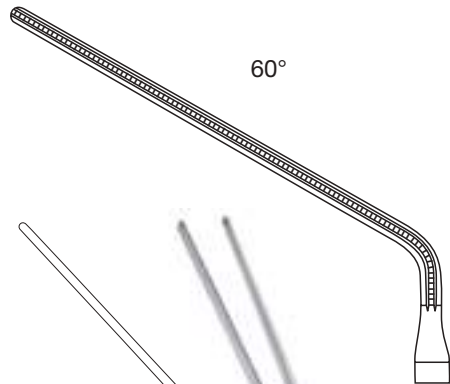

60°

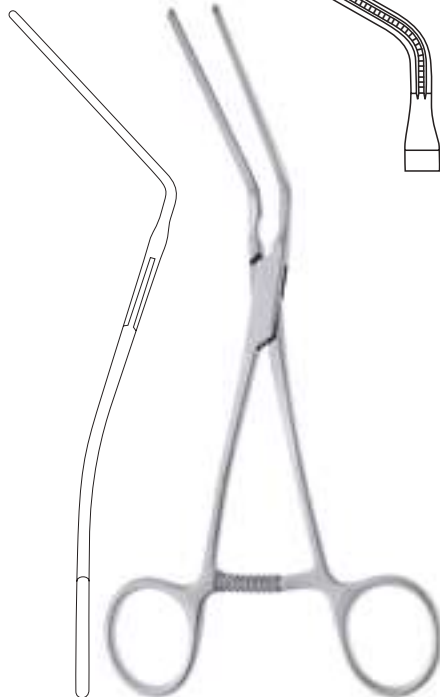

**55.50.16**  
 18 cm – 7½”  
**DeBakey “AT”**

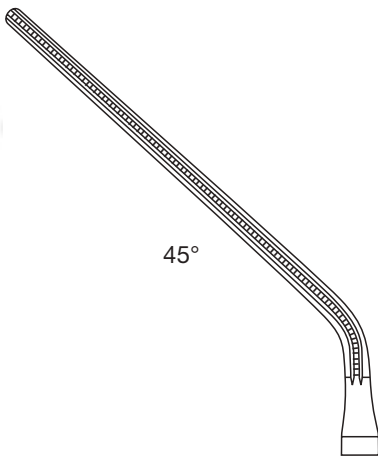

45°

**55.50.24**  
 18 cm – 7½”



**Gefäßklemmen**  
**Cardiovascular Clamps**  
**Pinzas vasculares**  
**Pinces vasculaires**  
**Pinze vascolari**

"AT" =  
atraumatische Riefung  
atraumatic serration  
estrias atraumáticas  
striure atraumatique  
striatura atraumatica

Peripheralgefäßklemmen  
Peripheral vascular clamps  
Pinzas para vasos periféricos  
Pinces pour vaisseaux périphériques  
Pinze emostatiche per vasi periferici

9



**55.52.34**  
16 cm – 6¼"  
**DeBakey "AT"**



**DeBakey "AT"**

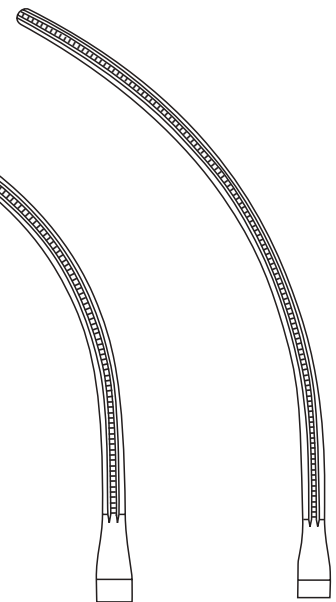

**55.52.48**  
18,5 cm – 7¼"

**55.52.47**  
20 cm – 8"



**Gefäßklemmen**  
**Cardiovascular Clamps**  
**Pinzas vasculares**  
**Pinces vasculaires**  
**Pinze vascolari**

“AT” =  
 atraumatische Riefung  
 atraumatic serration  
 estrias atraumáticas  
 striure atraumatique  
 striatura atraumatica



Peripheralgefäßklemmen  
 Peripheral vascular clamps  
 Pinzas para vasos periféricos  
 Pinces pour vaisseaux périphériques  
 Pinze emostatiche per vasi periferici



**Dale “AT”**

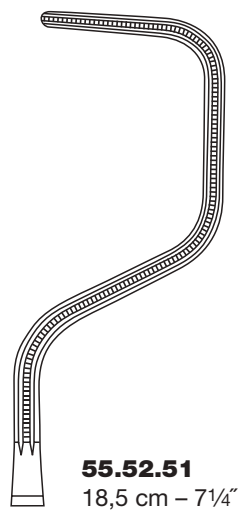

**55.52.51**  
 18,5 cm – 7¼”

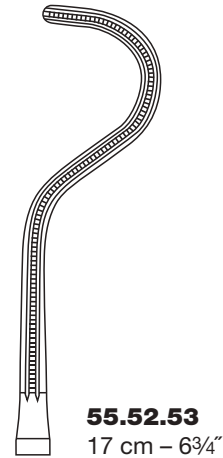

**55.52.53**  
 17 cm – 6¾”

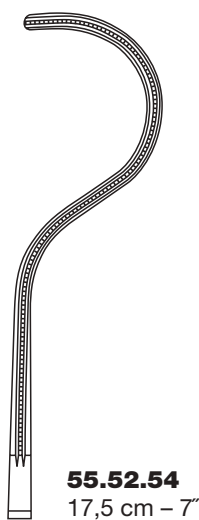

**55.52.54**  
 17,5 cm – 7”

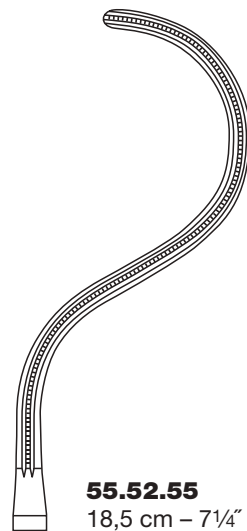

**55.52.55**  
 18,5 cm – 7¼”



**Gefäßklemmen**  
**Cardiovascular Clamps**  
**Pinzas vasculares**  
**Pinces vasculaires**  
**Pinze vascolari**

"AT" =  
atraumatische Riefung  
atraumatic serration  
estrias atraumáticas  
striure atraumatique  
striatura atraumatica

Peripheralgefäßklemmen  
Peripheral vascular clamps  
Pinzas para vasos periféricos  
Pinces pour vaisseaux périphériques  
Pinze emostatiche per vasi perifici

9

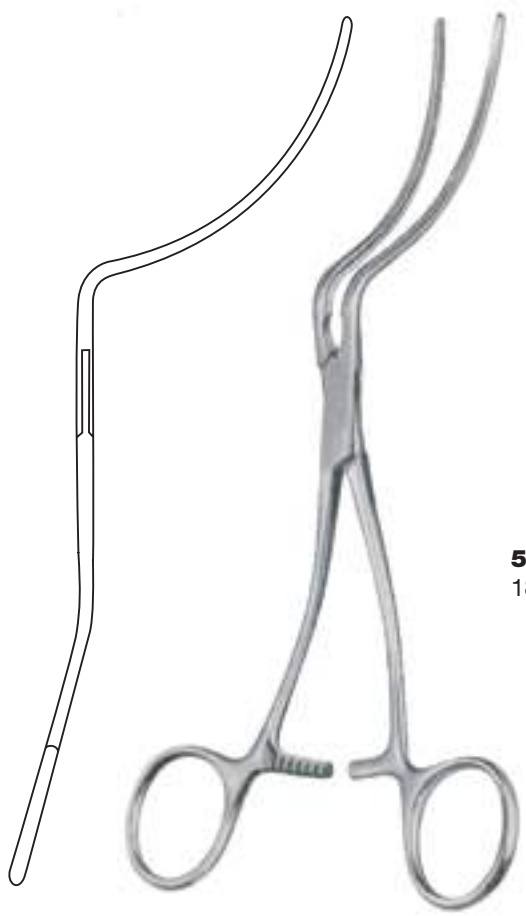

**DeBakey "AT"**

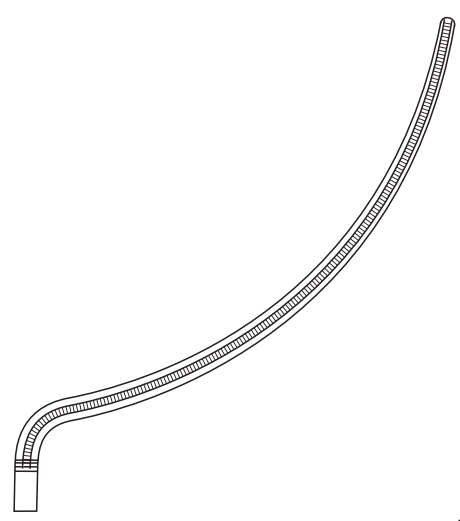

**55.52.59**  
18 cm – 7 1/8"

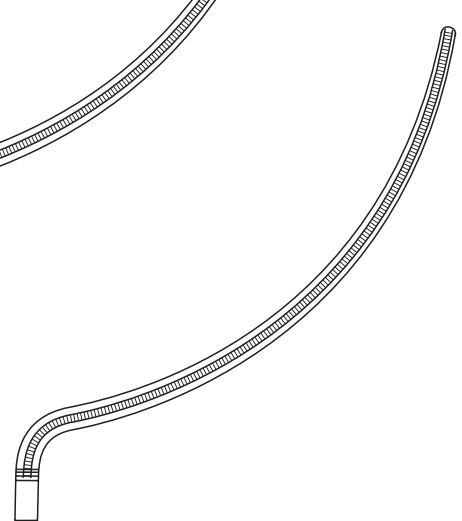

**55.52.60**  
20 cm – 8"



**Gefäßklemmen**  
**Cardiovascular Clamps**  
**Pinzas vasculares**  
**Pinces vasculaires**  
**Pinze vascolari**



9

Nierenarterienklemmen  
 Renal hemostatic clamps  
 Pinzas para arteria renal  
 Pinces pour artères rénales  
 Pinze per arteria renale

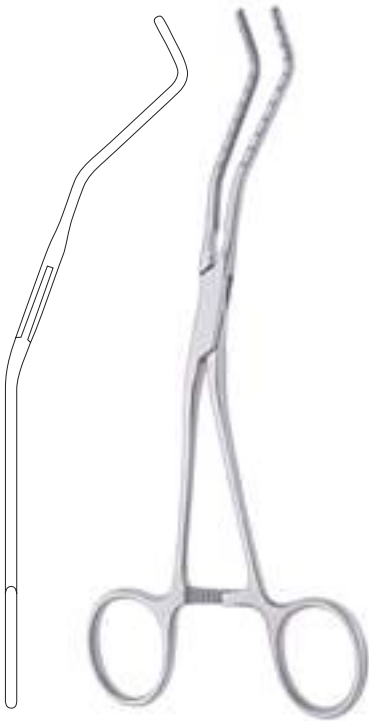

“AT”

“AT” =  

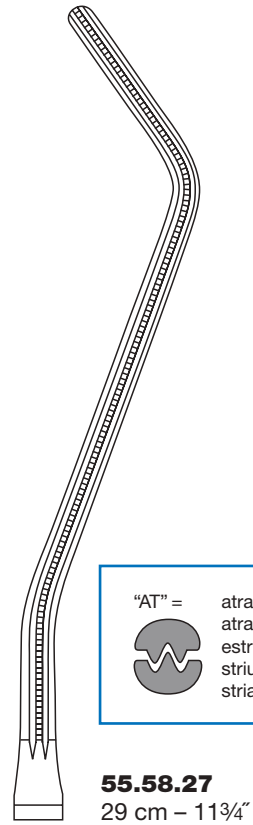
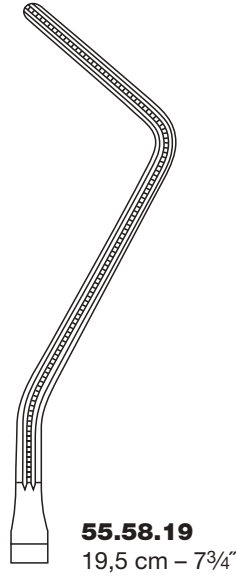
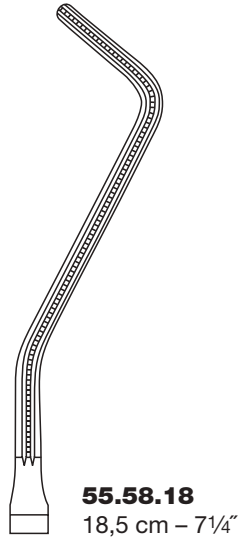
 atraumatische Riefung  
 atraumatic serration  
 estrias atraumáticas  
 striure atraumatique  
 striatura atraumatica

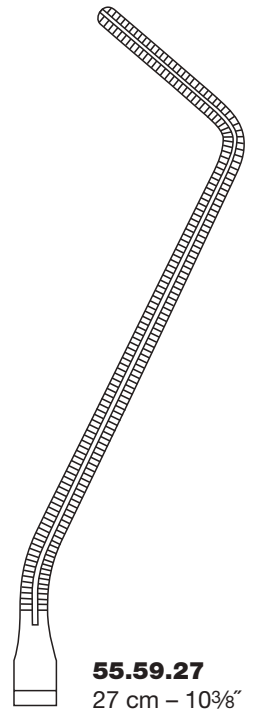
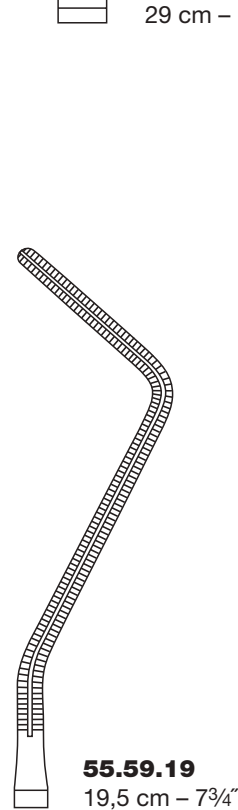
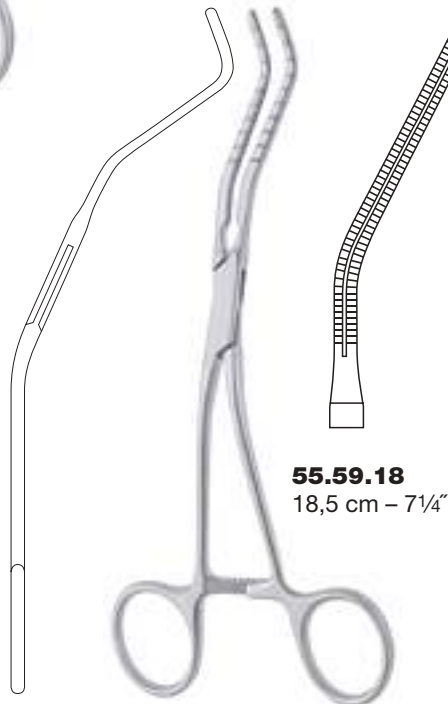

“AT” =  

 atraumatische Riefung  
 atraumatic serration  
 estrias atraumáticas  
 striure atraumatique  
 striatura atraumatica

**Cooley “AT”**





**Gefäßklemmen**  
**Cardiovascular Clamps**  
**Pinzas vasculares**  
**Pinces vasculaires**  
**Pinze vascolari**

"AT" =  
atraumatische Riefung  
atraumatic serration  
estrias atraumáticas  
striure atraumatique  
striatura atraumatica

Nierenarterienklemmen  
Renal hemostatic clamps  
Pinzas para arteria renal  
Pinces pour artères rénales  
Pinze per arteria renale

9



**Hopt "AT"**

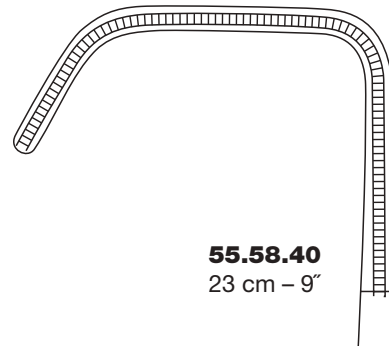

**55.58.40**  
23 cm – 9"

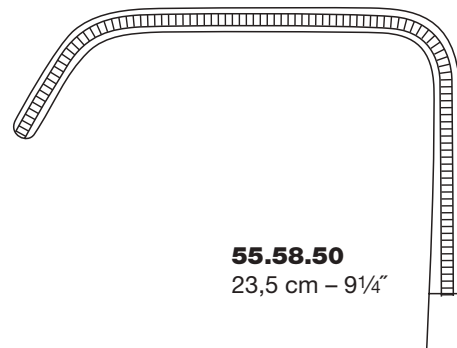

**55.58.50**  
23,5 cm – 9¼"

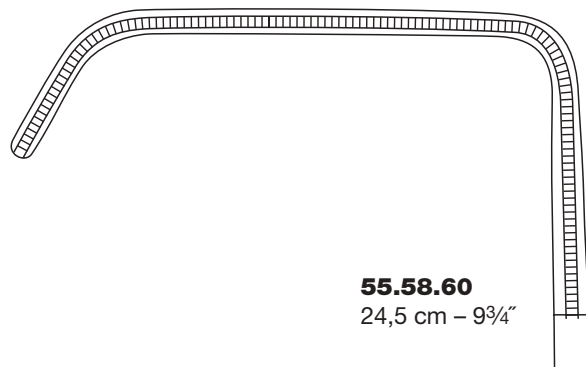

**55.58.60**  
24,5 cm – 9¾"



**Gefäßklemmen**  
**Cardiovascular Clamps**  
**Pinzas vasculares**  
**Pinces vasculaires**  
**Pinze vascolari**

"AT" =  
 atraumatische Riefung  
 atraumatic serration  
 estriás atraumáticas  
 striure atraumatique  
 striatura atraumatica

Aorta-Aneurysma-Klemmen  
 Aortic aneurysm clamps  
 Pinzas para aneurisma de aorta  
 Pinces pour anévrisme de l'aorte  
 Pinze per aneurisma d'aorta

9

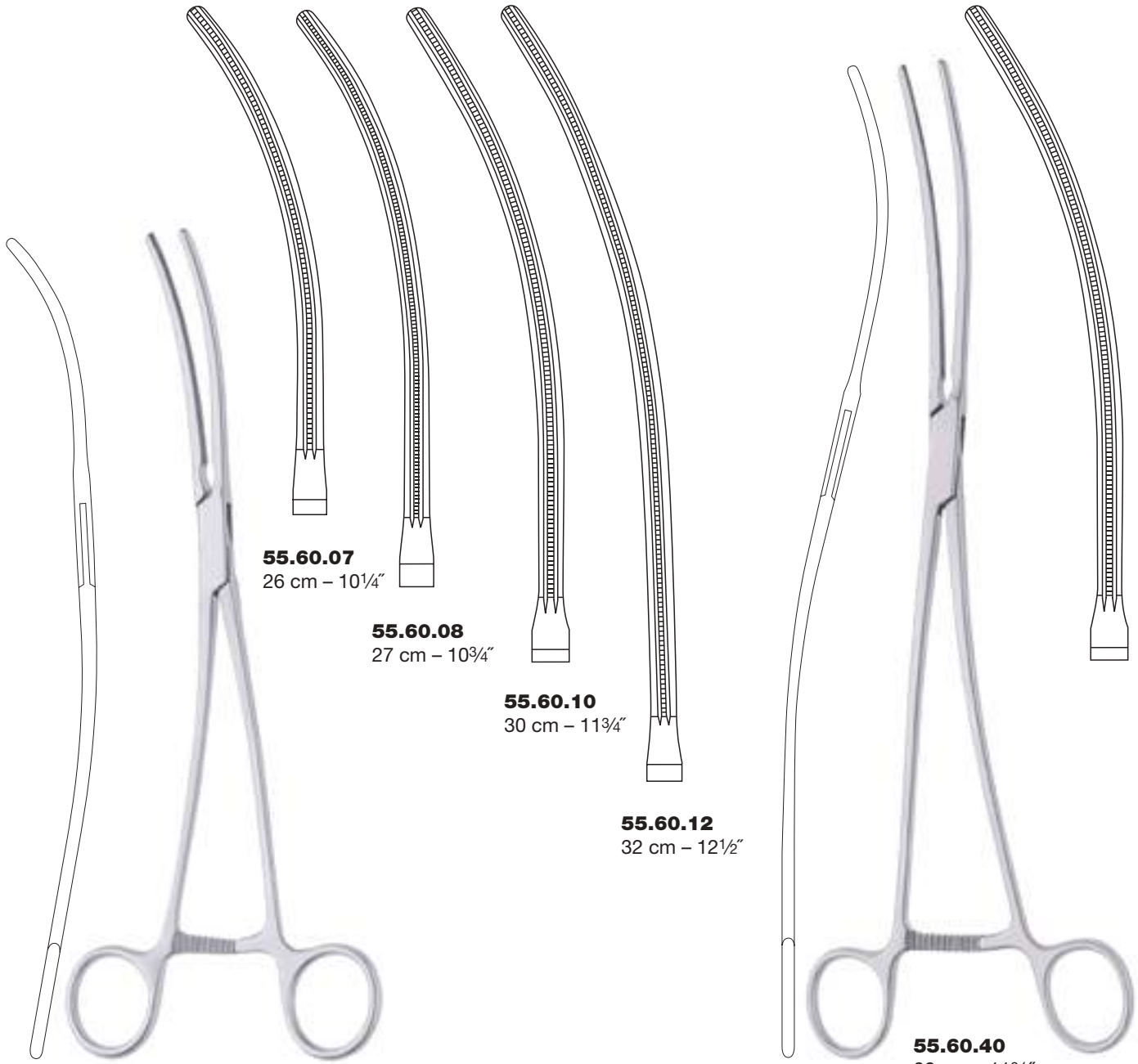

**55.60.07**  
 26 cm – 10¼"

**55.60.08**  
 27 cm – 10¾"

**55.60.10**  
 30 cm – 11¾"

**55.60.12**  
 32 cm – 12½"

**55.60.40**  
 30 cm – 11¾"  
**DeBakey "AT"**

**DeBakey "AT"**



**Gefäßklemmen**  
**Cardiovascular Clamps**  
**Pinzas vasculares**  
**Pinces vasculaires**  
**Pinze vascolari**

"AT" =  
 atraumatic serration  
 estrías atraumáticas  
 striure atraumatique  
 striatura atraumatica



Aorta-Aneurysma-Klemmen  
 Aortic aneurysm clamps  
 Pinzas para aneurisma de aorta  
 Pinces pour anévrisme de l'aorte  
 Pinze per aneurisma d'aorta

Ligaturklemmen  
 Ligature clamps  
 Pinzas para ligadura  
 Pinces à ligature  
 Pinze per legatura

9

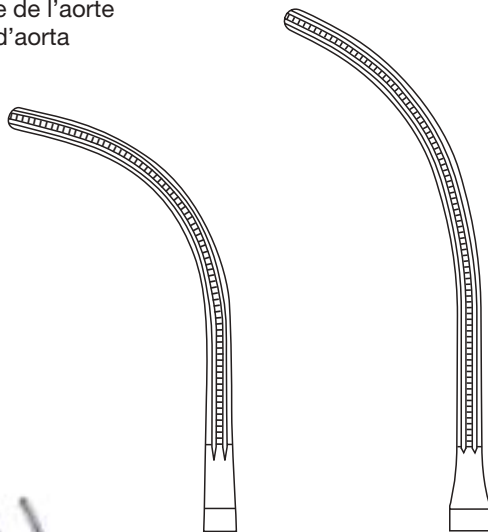

**55.64.35**  
 23 cm – 9"

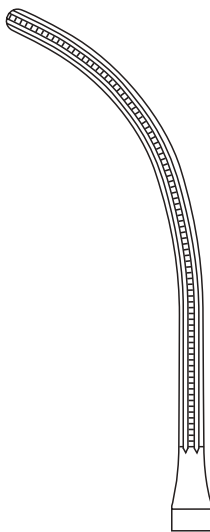

**55.64.36**  
 24 cm – 9½"

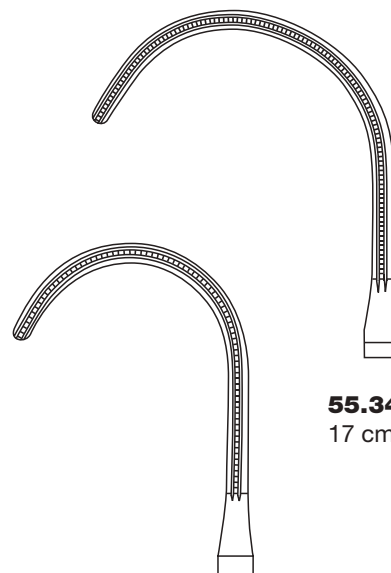

**55.34.47**  
 17 cm – 6¾"

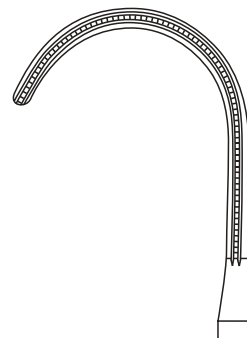

**55.34.46**  
 16 cm – 6¼"

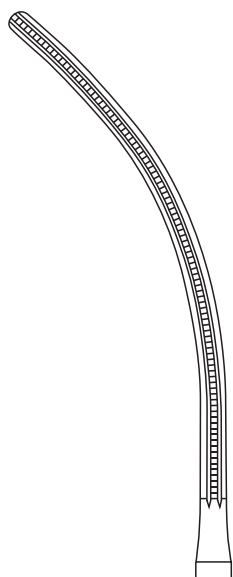

**55.64.37**  
 25 cm – 10"



**DeBakey "AT"**



**DeBakey "AT"**



**Gefäßklemmen**  
**Cardiovascular Clamps**  
**Pinzas vasculares**  
**Pinces vasculaires**  
**Pinze vascolari**

“AT” =  
 atraumatische Riefung  
 atraumatic serration  
 estrías atraumáticas  
 striure atraumatique  
 striatura atraumatica

Ligaturklemmen  
 Ligature clamps  
 Pinzas para ligadura  
 Pinces à ligature  
 Pinze per legatura

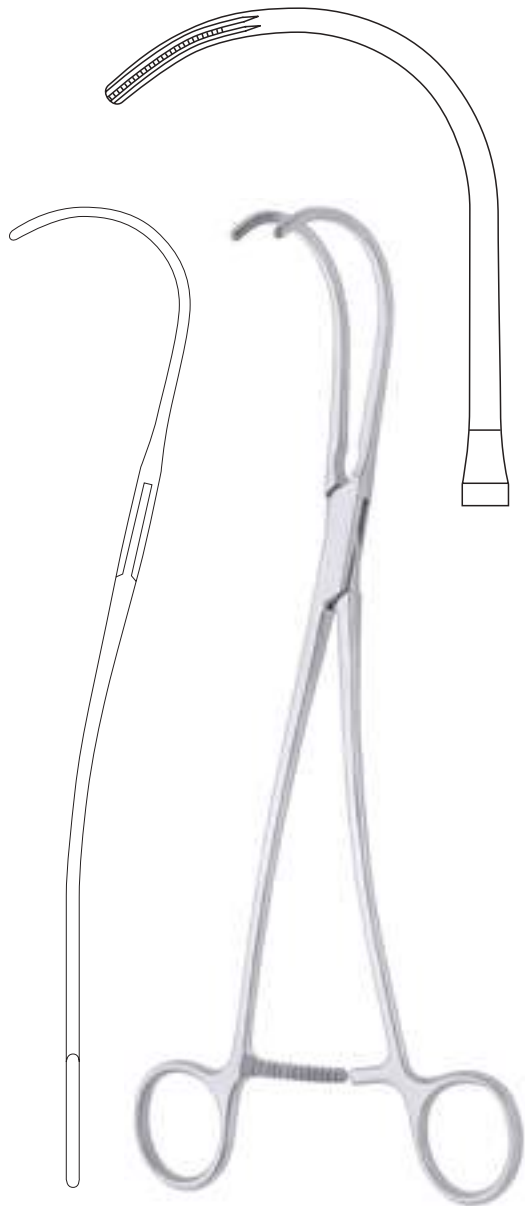

**55.64.55**  
 26,5 cm – 10½”  
**Semb-DeBakey “AT”**

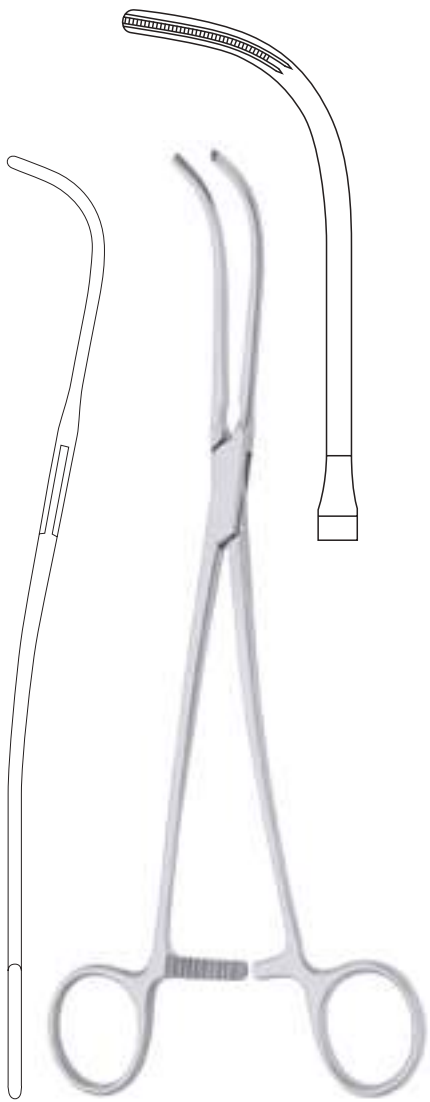

**55.64.65**  
 24 cm – 9½”  
**DeBakey “AT”**

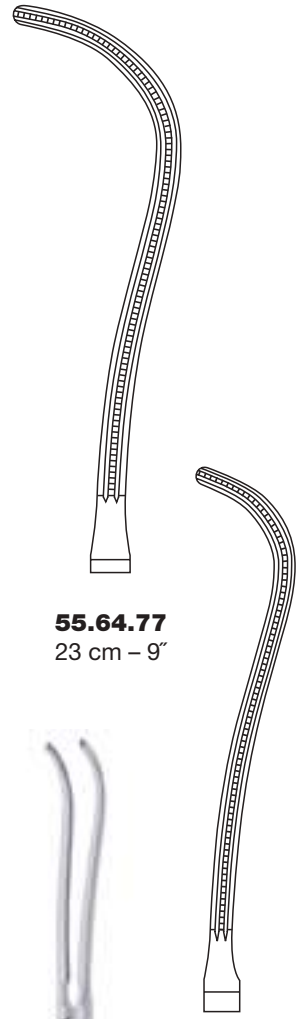

**55.64.77**  
 23 cm – 9”

**55.64.76**  
 19 cm – 7½”



**DeBakey “AT”**

9



**Gefäßklemmen**  
**Cardiovascular Clamps**  
**Pinzas vasculares**  
**Pinces vasculaires**  
**Pinze vascolari**

Vena-Cava-Klemmen  
Vena cava clamps  
Pinzas de vena cava  
Pinces pour vena cava  
Pinze per vena cava

9



**55.22.15**  
16 cm – 6¼"  
**Satinsky-Baby**

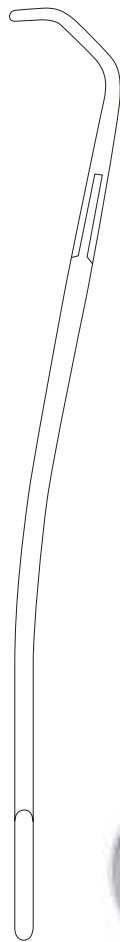

**Satinsky**

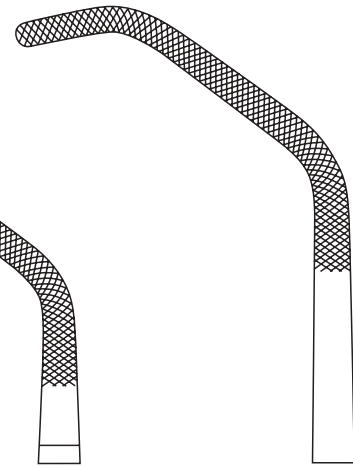

**55.22.27**  
# 1  
24 cm – 9½"

**55.22.28**  
# 2  
27 cm – 10¾"



**Gefäßklemmen**  
**Cardiovascular Clamps**  
**Pinzas vasculares**  
**Pinces vasculaires**  
**Pinze vascolari**

“AT” =  
 atraumatische Riefung  
 atraumatic serration  
 estriás atraumáticas  
 striure atraumatique  
 striatura atraumatica

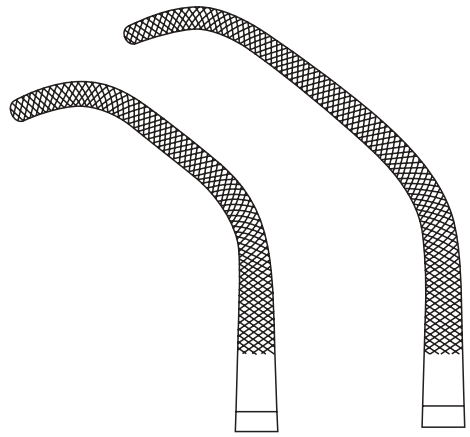

**55.22.81** # 1  
22 cm – 8¾”

**55.22.82** # 2  
23 cm – 9”

Vena-Cava-Klemmen  
 Vena cava clamps  
 Pinzas de vena cava  
 Pinces pour vena cava  
 Pinze per vena cava

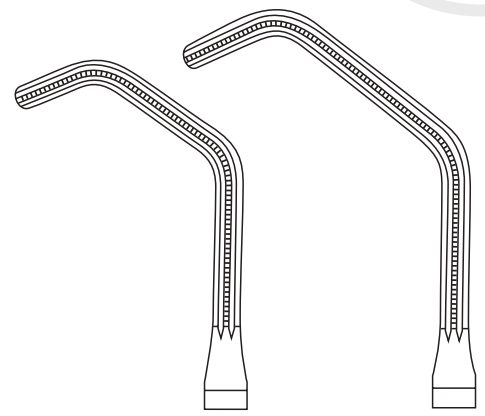

**55.74.32**  
23,5 cm – 9¼”

**55.74.40**  
24 cm – 9½”

9

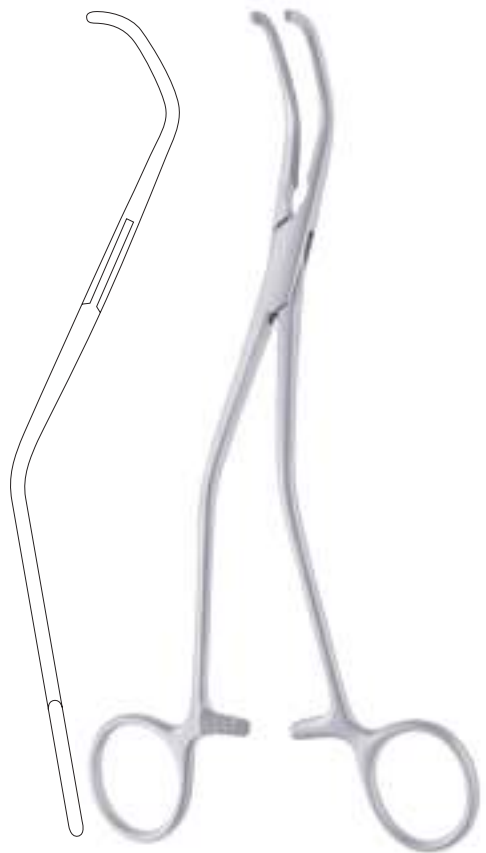

**Potts-Satinsky**



**Satinsky-DeBakey “AT”**



**55.74.50**  
25 cm – 10”



**Gefäßklemmen**  
**Cardiovascular Clamps**  
**Pinzas vasculares**  
**Pinces vasculaires**  
**Pinze vascolari**

"AT" =



atraumatische Riefung  
 atraumatic serration  
 estrías atraumáticas  
 striure atraumatique  
 striatura atraumatica

Vena-Cava-Klemmen  
 Vena cava clamps  
 Pinzas de vena cava  
 Pinces pour vena cava  
 Pinze per vena cava

9

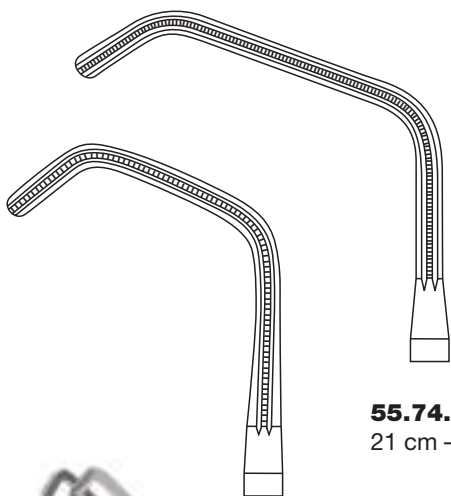

**55.74.53**  
 21 cm – 9¼"

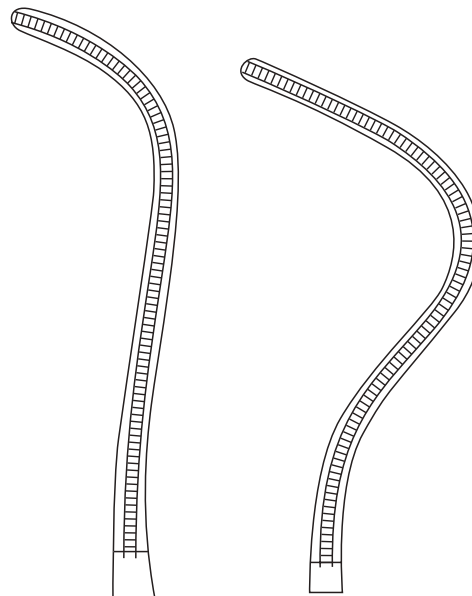

**55.74.55**  
 25,5 cm – 10"

**55.74.56**  
 24,5 cm – 9¾"



**55.74.52**  
 20,5 cm – 8"

**DeBakey Beck "AT"**



**DeBakey Harken "AT"**

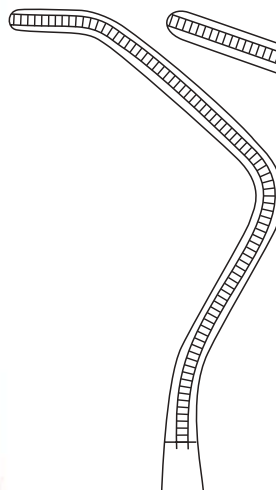

**55.74.57**  
 24,5 cm – 9¾"



**55.74.58**  
 24 cm – 9½"



**Gefäßklemmen**  
**Cardiovascular Clamps**  
**Pinzas vasculares**  
**Pinces vasculaires**  
**Pinze vascolari**



"AT" =  
 atraumatische Riefung  
 atraumatic serration  
 estrías atraumáticas  
 striure atraumatique  
 striatura atraumatica



"AT" =  
 atraumatische Riefung  
 atraumatic serration  
 estrías atraumáticas  
 striure atraumatique  
 striatura atraumatica



Aorta-Klemmen  
 Aorta clamps  
 Pinzas para aorta  
 Pinces pour l'aorte  
 Pinze per aorta

9

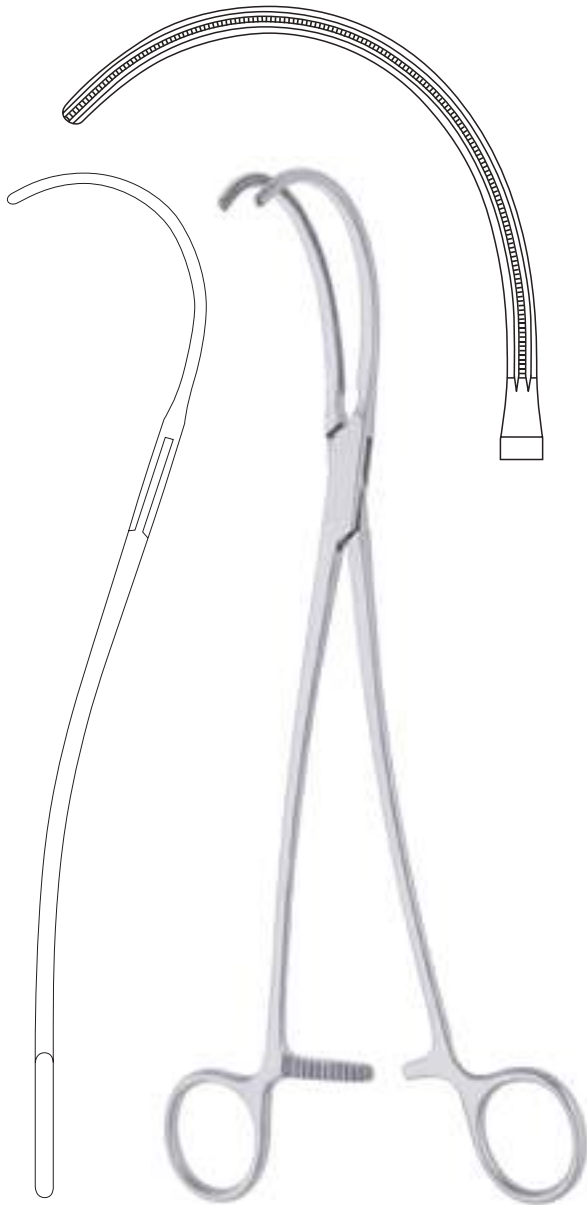

**55.64.46**  
 26,5 cm – 10½"  
**DeBakey "AT"**

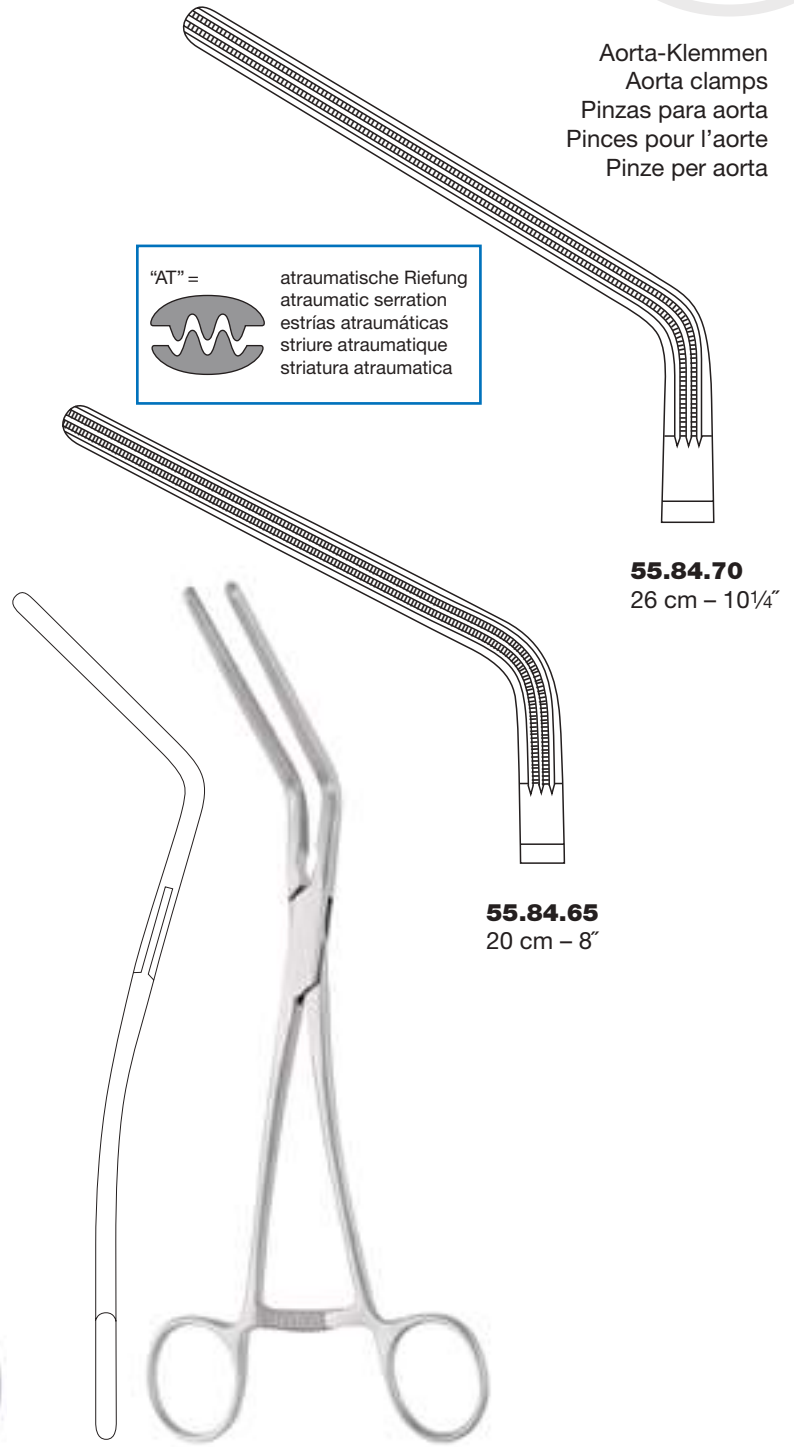

**55.84.65**  
 20 cm – 8"

**DeBakey "AT"**



**Gefäßklemmen**  
**Cardiovascular Clamps**  
**Pinzas vasculares**  
**Pinces vasculaires**  
**Pinze vascolari**

“AT” =  
atraumatische Riefung  
atraumatic serration  
estrias atraumáticas  
striure atraumatique  
striatura atraumatica



Aorta-Klemmen  
Aorta clamps  
Pinzas para aorta  
Pinces pour l'aorte  
Pinze per aorta

9

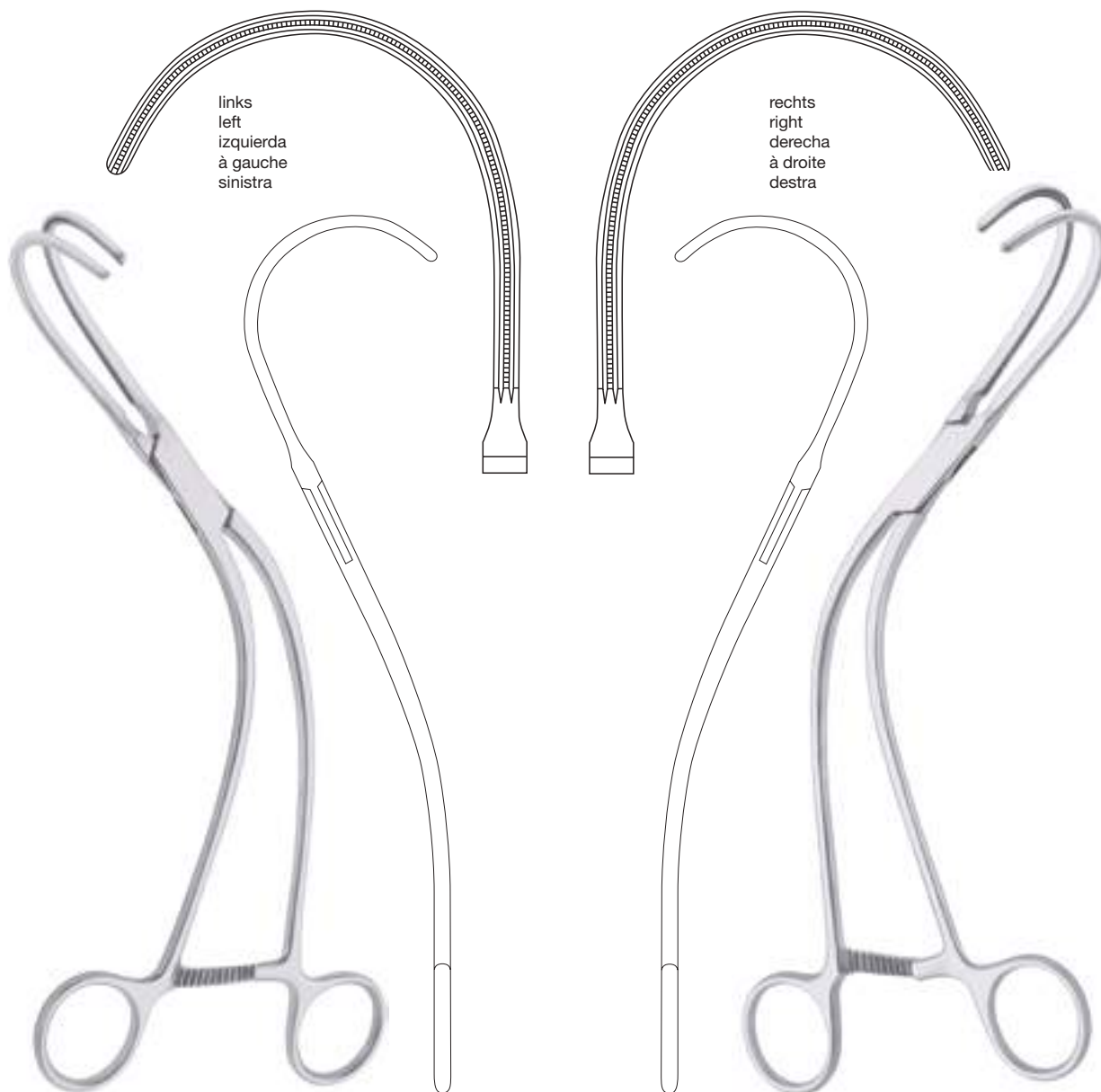

**55.64.81**  
26 cm – 10¼”  
**Weber “AT”**

**55.64.82**  
26 cm – 10¼”  
**Weber “AT”**



**Gefäßklemmen**  
**Cardiovascular Clamps**  
**Pinzas vasculares**  
**Pinces vasculaires**  
**Pinze vascolari**

“AT” =  
atraumatische Riefung  
atraumatic serration  
estriás atraumáticas  
striure atraumatique  
striatura atraumatica



Aorta-Klemme  
Aorta clamp  
Pinza para aorta  
Pince pour l'aorte  
Pinza per aorta

9



**55.64.94**  
21 cm – 8¼"  
**Lambert-Kay “AT”**



**Gefäßklemmen**  
**Cardiovascular Clamps**  
**Pinzas vasculares**  
**Pinces vasculaires**  
**Pinze vascolari**

**Neonatal**

9

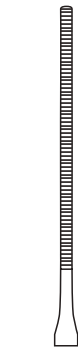

**55.33.04**

12,5 cm – 5"  
**Neonatal "AT"**

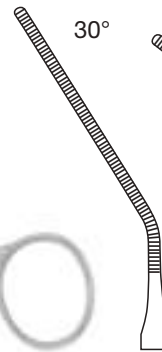
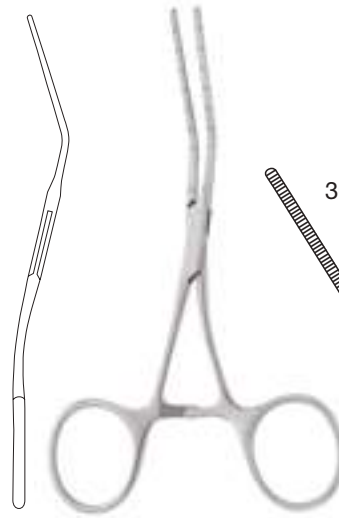

30°

12,5 cm – 5"  
**Neonatal "AT"**

**55.33.34**

Neonatal-Klemmen  
 Neonatal clamps  
 Pinzas para recién nacidos  
 Pinces pour nouveaux-nés  
 Pinze neonatali

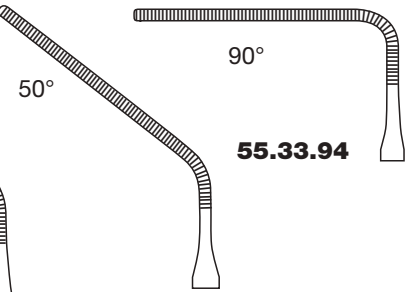

50°

90°

**55.33.94**

**55.33.54**

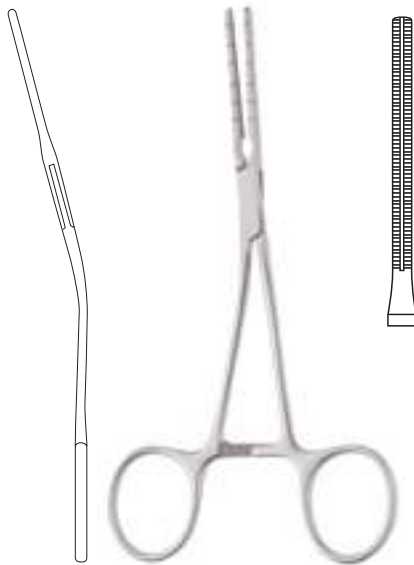

**55.33.12**  
 14 cm – 5½"  
**Cooley "AT"**

"AT" =  
  
 atraumatische Riefung  
 atraumatic serration  
 estrias atraumáticas  
 striure atraumatique  
 striatura atraumatica



**55.33.10**

14 cm – 5½"  
**Cooley "AT"**

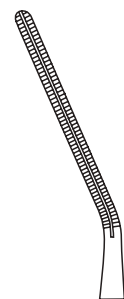

**55.37.73**



**Neonatal**

Neonatal-Klemmen  
 Neonatal clamps  
 Pinzas para recién nacidos  
 Pinces pour nouveaux-nés  
 Pinze neonatali



**55.39.18**

**55.39.20**

**55.39.25**

12 cm – 4<sup>3</sup>/<sub>4</sub>"  
**Neonatal "AT"**

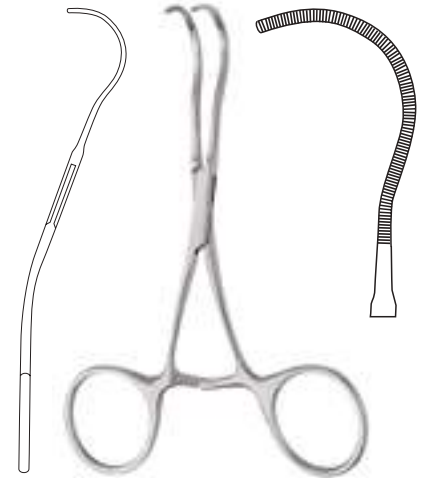

**55.39.29**  
 12 cm – 4<sup>3</sup>/<sub>4</sub>"  
**Neonatal "AT"**

"AT" =  
  
 atraumatische Riefung  
 atraumatic serration  
 estrías atraumáticas  
 striure atraumatique  
 striatura atraumatica

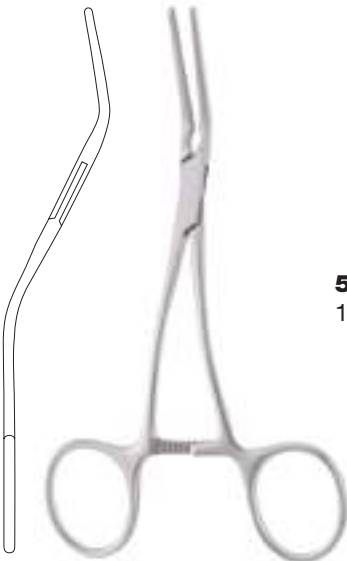

**Cooley "AT"**



**55.33.21**  
 14 cm – 5<sup>1</sup>/<sub>2</sub>"

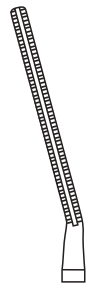

**55.33.22**  
 14 cm – 5<sup>1</sup>/<sub>2</sub>"

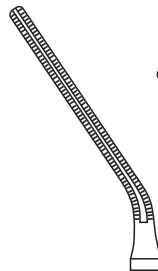

**55.33.23**  
 14 cm – 5<sup>1</sup>/<sub>2</sub>"

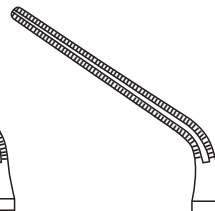

**55.33.24**  
 13 cm – 5<sup>1</sup>/<sub>8</sub>"



**55.33.25**  
 14 cm – 5<sup>1</sup>/<sub>2</sub>"

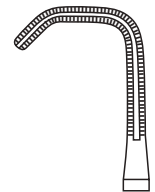

**55.33.26**  
 13 cm – 5<sup>1</sup>/<sub>8</sub>"

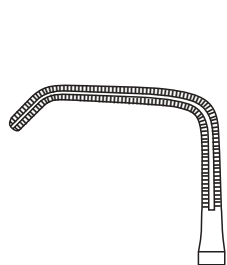

**55.33.27**  
 13 cm – 5<sup>1</sup>/<sub>8</sub>"

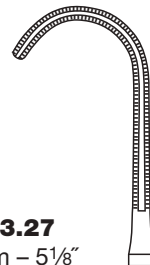

**55.33.28**  
 14 cm – 5<sup>1</sup>/<sub>2</sub>"

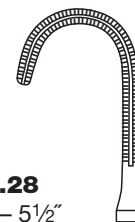

**55.33.29**  
 13,5 cm – 5<sup>3</sup>/<sub>8</sub>"



**Gefäßklemmen**  
**Cardiovascular Clamps**  
**Pinzas vasculares**  
**Pinces vasculaires**  
**Pinze vascolari**

**Neonatal**

"AT" =  
 atraumatic serration  
 estrías atraumáticas  
 striure atraumatique  
 striatura atraumatica

Neonatal-Klemmen  
 Neonatal clamps  
 Pinzas para recién nacidos  
 Pinces pour nouveaux-nés  
 Pinze neonatali

9

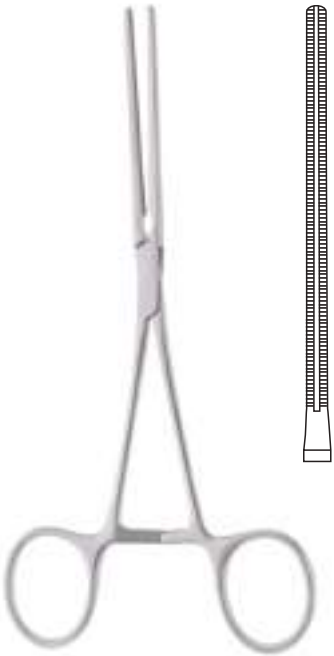

**55.33.40**  
 16,5 cm – 6½"

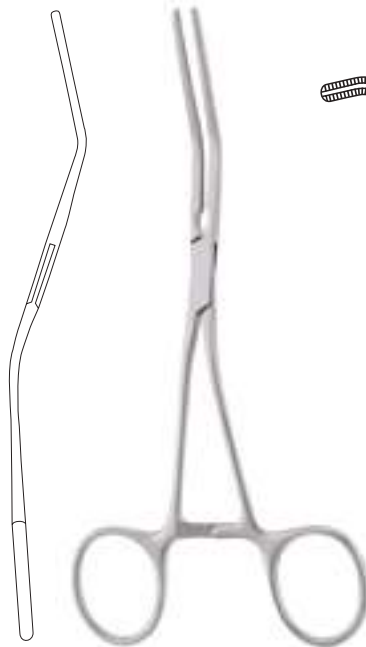

**Cooley "AT"**

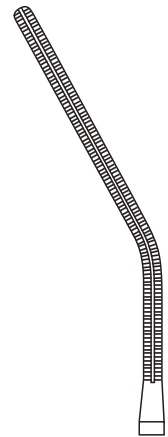

**55.33.41**  
 16 cm – 6¼"

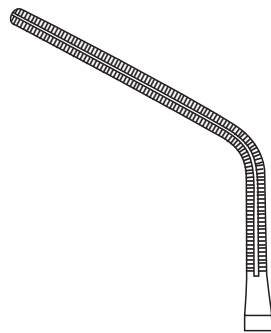

**55.33.42**  
 15 cm – 6"

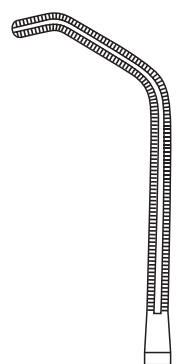

**55.33.43**  
 15 cm – 6"

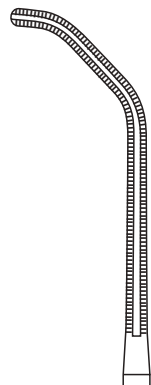

**55.33.45**  
 15,5 cm – 6⅛"



**Gefäßklemmen**  
**Cardiovascular Clamps**  
**Pinzas vasculares**  
**Pinces vasculaires**  
**Pinze vascolari**

"AT" =  
 atraumatische Riefung  
 atraumatic serration  
 estrías atraumáticas  
 striure atraumatique  
 striatura atraumatica

**Neonatal**

Neonatal-Klemmen  
 Neonatal clamps  
 Pinzas para recién nacidos  
 Pinces pour nouveaux-nés  
 Pinze neonatali

9



**55.33.47**  
 15,5 cm – 6 1/8"  
**DeBakey "AT" Subramanian**

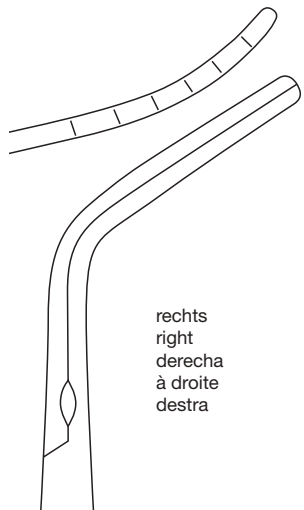

**55.33.48**  
 16 cm – 6 1/4"  
**Subramanian**

rechts  
 right  
 derecha  
 à droite  
 destra

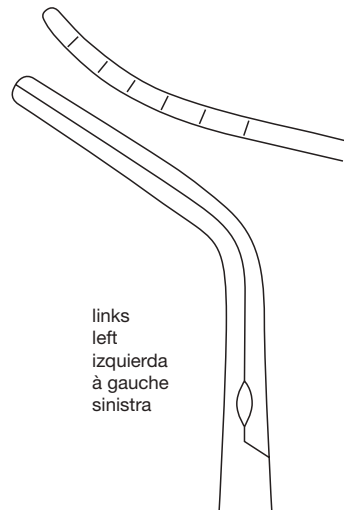

links  
 left  
 izquierda  
 à gauche  
 sinistra

**55.33.49**  
 16 cm – 6 1/4"  
**Subramanian**





**Gefäßklemmen**  
**Cardiovascular Clamps**  
**Pinzas vasculares**  
**Pinces vasculaires**  
**Pinze vascolari**

**Neonatal**

"AT" =  
 atraumatic serration  
 estrías atraumáticas  
 striure atraumatique  
 striatura atraumatica

Neonatal-Klemmen  
 Neonatal clamps  
 Pinzas para recién nacidos  
 Pinces pour nouveaux-nés  
 Pinze neonatali

9

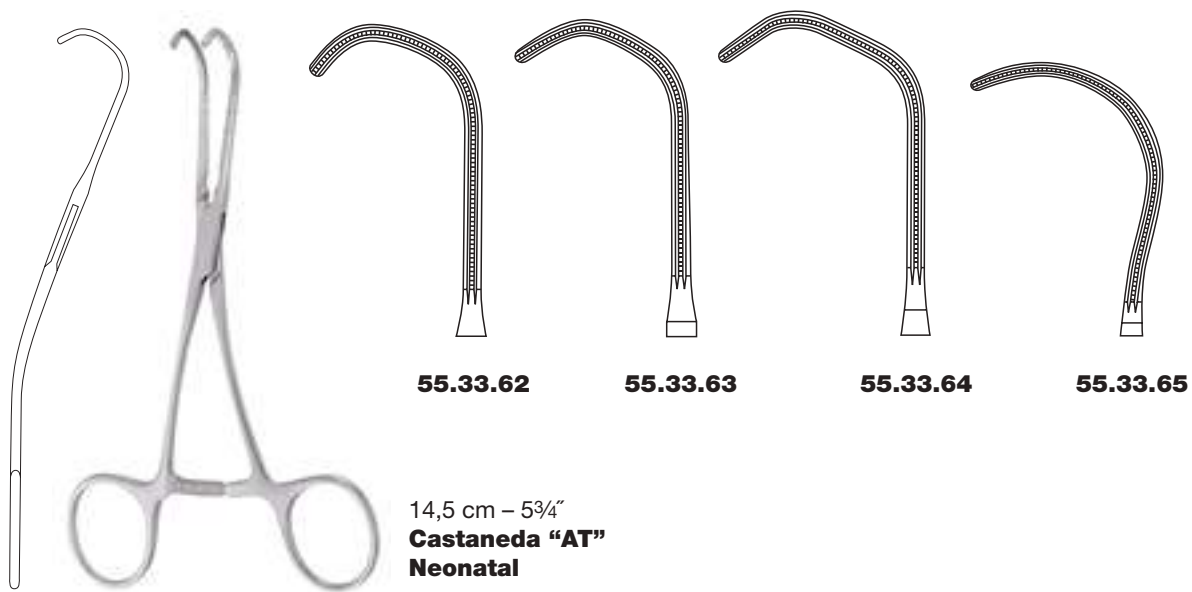
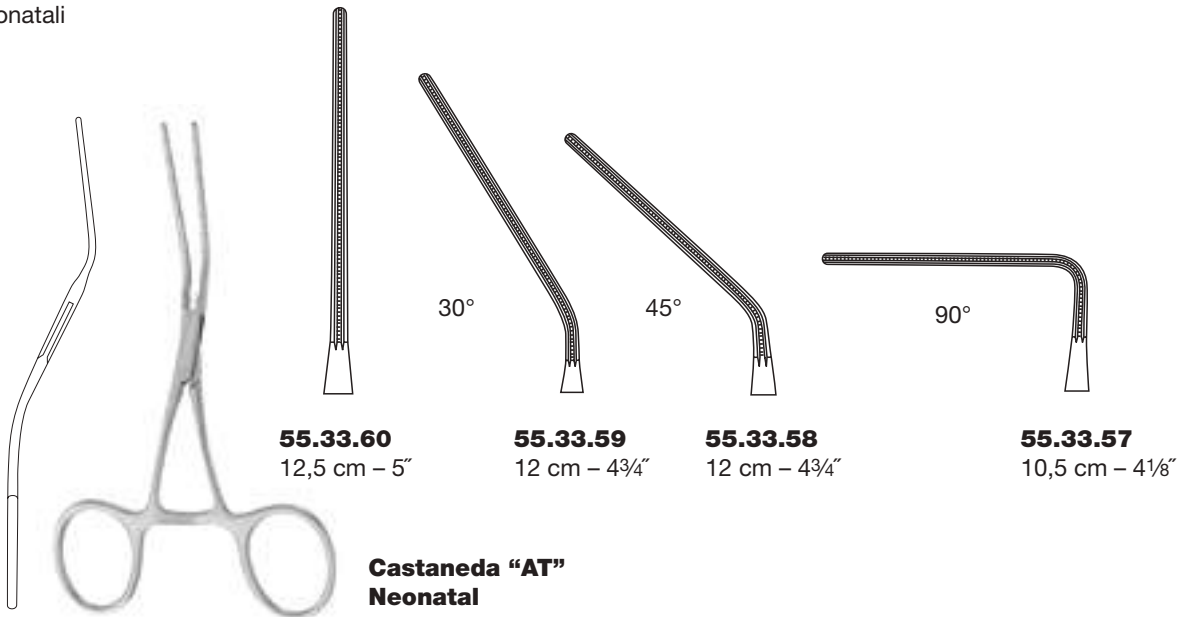





Katheterklemmen  
 Catheter clamps  
 Pinzas para catéteres  
 Pinces pour cathéters  
 Pinze per cateteri



**Cooley**

	Länge length longitud longueur lunghezza	Charr.	
<b>55.86.91</b>	16,5 cm – 6½"	24	für Kinder for children para niños pour enfants per bambini
<b>55.86.92</b>	16,5 cm – 6½"	26	
<b>55.86.93</b>	20 cm – 8"	28	für Erwachsene for adults para adultos pour adultes per adulti
<b>55.86.94</b>	20 cm – 8"	30	
<b>55.86.95</b>	20 cm – 8"	32	
<b>55.86.96</b>	20 cm – 8"	34	
<b>55.86.97</b>	20 cm – 8"	36	

**Gewebefasszangen**  
**Tissue Grasping Forceps**  
**Pinzas para agarrar tejidos**  
**Pinces pour saisir le tissu**  
**Pinze per afferrare tessuti**



**Gewebefasszangen**  
**Tissue Grasping Forceps**  
**Pinzas para agarrar tejidos**  
**Pinces pour saisir le tissu**  
**Pinze per afferrare tessuti**

10



**17.36.05**  
15 cm – 6"  
**Collin**



**Duval**

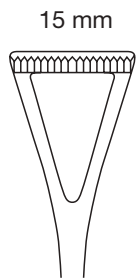

**17.36.45**  
21 cm – 8 $\frac{1}{4}$ "  
**17.36.65**  
23 cm – 9"

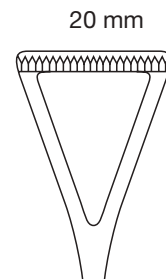

**17.36.50**  
21 cm – 8 $\frac{1}{4}$ "  
**17.36.70**  
23 cm – 9"

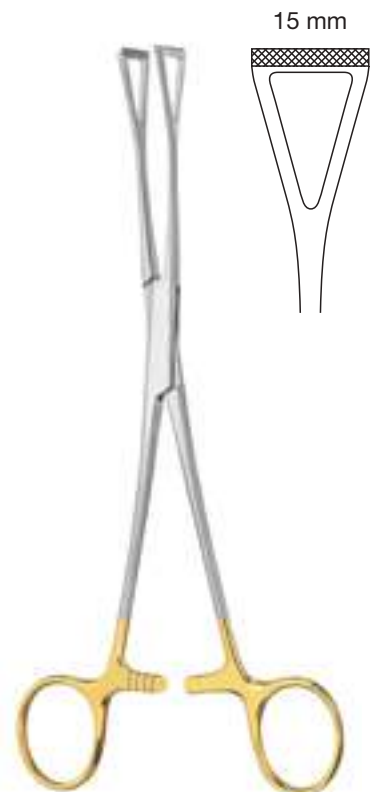

**17.36.46**  
19 cm – 7 $\frac{1}{2}$ "  
**Duval "HM"**

**Gewebefasszangen**  
**Tissue Grasping Forceps**  
**Pinzas para agarrar tejidos**  
**Pinces pour saisir le tissu**  
**Pinze per afferrare tessuti**



"AT" =  
 atraumatische Riefung  
 atraumatic serration  
 estrías atraumáticas  
 striure atraumatique  
 striatura atraumatica



20 mm

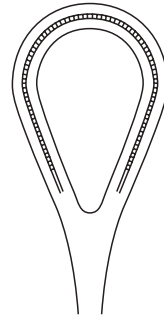

**17.32.75**  
 25 cm – 10"

25 mm

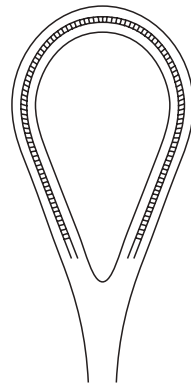

**17.32.77**  
 27 cm – 10<sup>3</sup>/<sub>4</sub>"

25 mm

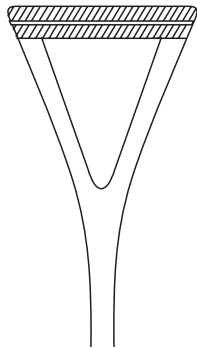

**17.36.82**  
 23 cm – 9"  
**Duval "AT"**



**DeBakey "AT"**

10



**Gewebefasszangen**  
**Tissue Grasping Forceps**  
**Pinzas para agarrar tejidos**  
**Pinces pour saisir le tissu**  
**Pinze per afferrare tessuti**

10



**50.03.15**  
15 cm – 6"

**50.03.20**  
20 cm – 8"

**Allis "AT"**



**50.03.16**  
15 cm – 6"

**50.03.19**  
20 cm – 8"



**50.03.25**  
25,5 cm – 10"

**50.03.27**  
30 cm – 11¾"

**Allis "AT"**



**50.08.16**  
16 cm – 6¼"  
**Williams**

**Gewebefasszangen**  
**Tissue Grasping Forceps**  
**Pinzas para agarrar tejidos**  
**Pinces pour saisir le tissu**  
**Pinze per afferrare tessuti**



10





**Gewebefasszangen**  
**Tissue Grasping Forceps**  
**Pinzas para agarrar tejidos**  
**Pinces pour saisir le tissu**  
**Pinze per afferrare tessuti**

10



**Babcock "AT"**

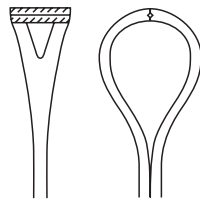

**50.11.16**  
16 cm – 6¼"

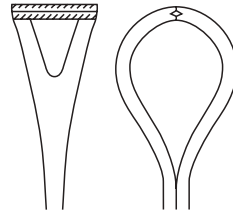

**50.11.20**  
20 cm – 9"

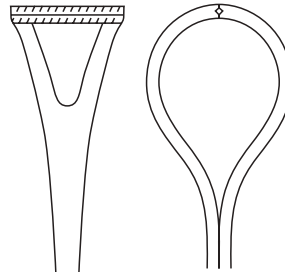

**50.11.23**  
23 cm – 9"

**Gefäßhäkchen · Wundhaken  
Vessel Hooks · Retractors  
Ganchos para vasos · Separadores  
Crochets pour vaisseaux · Ecarteurs  
Uncinetti vascolari · Divaricatori**





**Gefäßhäkchen**  
**Vessel Hooks**  
**Ganchos para vasos**  
**Crochets pour vaisseaux**  
**Uncinetti vascolari**

11

  <p><b>20.20.12</b> 13 cm – 5 1/8" <b>Moldestad</b></p>	 <p><b>20.20.17</b></p>	  <p><b>20.20.18</b></p> <p>Venenhäkchen          Vein hooks          Ganchitos para venas          Crochets à veines          Uncini per vene</p>	  <p>4 mm</p> <p><b>20.20.34</b> 16 cm – 6 1/4"</p>	   <p><b>20.20.57</b> <b>20.20.59</b> 7 mm 9 mm</p>
  <p><b>20.22.01</b> 2 mm</p>  <p><b>20.22.02</b> 3 mm</p>  <p><b>20.22.03</b> 4 mm</p> <p>14 cm – 5 1/2" <b>Lucae</b></p>	  <p><b>20.22.31</b> 4 mm</p>  <p><b>20.22.32</b> 6 mm</p> <p>19 cm – 7 1/2" <b>Cushing</b></p>	   <p><b>20.22.36</b> <b>20.22.37</b> 4 mm 6 mm</p>  <p><b>20.22.38</b> 8 mm</p> <p>Nervhäkchen          Nerve hooks          Ganchitos para nervios          Crochets à nerfs          Uncini per nervi</p> <p>28 cm – 11" <b>Cushing</b></p>		

**Feine Häkchen, Gefäßhäkchen**  
**Fine Hooks, Vessel Hooks**  
**Ganchitos, Ganchos para vasos**  
**Crochets fins, Crochets pour vaisseaux**  
**Uncini fini, Uncinetti vascolari**



11



19 cm – 7½"  
**Gillies**



**20.30.19**



**20.30.20**



18,5 cm – 7¼"  
**Krayenbühl**



**58.30.31**  
 3 mm

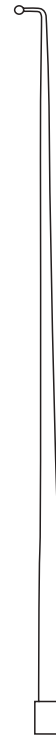

**58.30.32**  
 3,5 mm



**58.30.35**  
 2 mm



**58.30.36**  
 2,5 mm



**Feine Häkchen**  
**Fine Hooks**  
**Ganchitos**  
**Crochets fins**  
**Uncini fini**

11

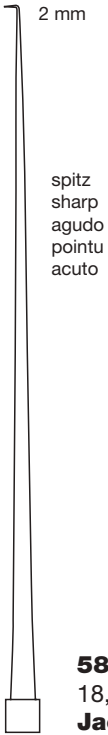

**58.30.26**  
 18,5 cm – 7¼”  
**Jacobson**

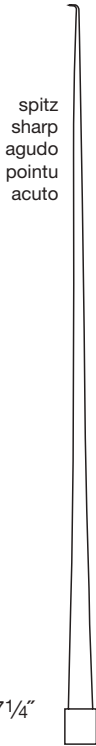

18,5 cm – 7¼”  
**Fisch**

**58.32.03**  
 90°, 1,5 mm



**58.32.04**  
 90°, 2,5 mm



23 cm – 9” **58.32.13**  
 90°, 1,5 mm



**58.32.18**  
 90°, 1,5 mm

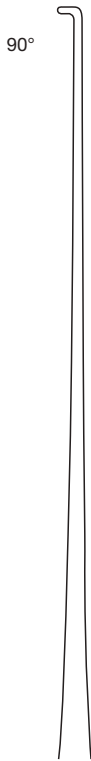





**57.49.10**  
 24 cm – 9½”  
**Eif**

**Wund- und Gefäßhaken  
Wound and Vessel Retractors  
Separadores y ganchos para vasos  
Ecarteurs et crochets pour vaisseaux  
Uncinetti e divaricatori per vasi**

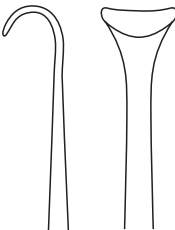
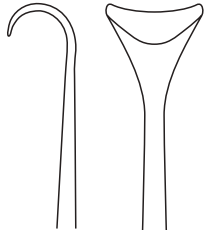
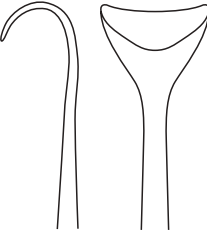

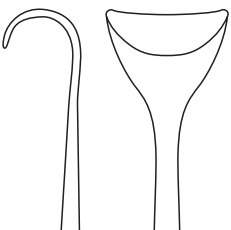
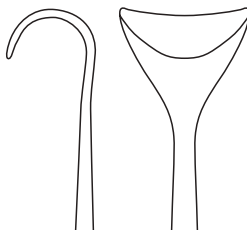
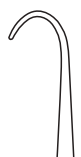
11

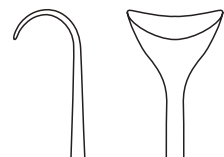
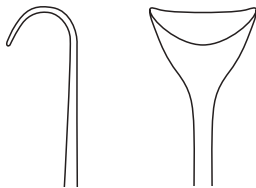
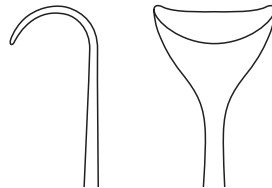
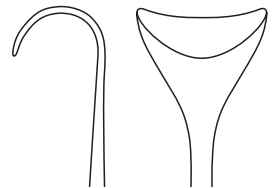
 14 cm – 5½" <b>Desmarres</b>	10 mm  <b>60.05.10</b> # 0	12 mm  <b>60.05.11</b> # 1	14 mm  <b>60.05.12</b> # 2	 17 cm – 6¾" <b>Koenig</b>	20.15.13 13 × 10 mm
	16 mm  <b>60.05.13</b> # 3	18 mm  <b>60.05.14</b> # 4	20.15.16 16 × 10 mm		
	8 mm  <b>20.17.08</b> 20 cm – 8" <b>20.17.28</b> 24 cm – 9½"	10 mm  <b>20.17.10</b> 20 cm – 8" <b>20.17.30</b> 24 cm – 9½"	12 mm  <b>20.17.12</b> 20 cm – 8" <b>20.17.32</b> 24 cm – 9½"		
	14 mm  <b>20.17.14</b> 20 cm – 8" <b>20.17.34</b> 24 cm – 9½"	16 mm  <b>20.17.16</b> 20 cm – 8" <b>20.17.36</b> 24 cm – 9½"	18 mm  <b>20.17.18</b> 20 cm – 8" <b>20.17.38</b> 24 cm – 9½"		

Venenhaken  
Vein retractors  
Ganchos para venas  
Ecarteurs à veines  
Divaricatori per vene

**Cushing**



**Wund- und Gefäßhäkchen**  
**Wound and Vessel Retractors**  
**Separadores y ganchos para vasos**  
**Ecarteurs et crochets pour vaisseaux**  
**Uncinetti e divaricatori per vasi**

11

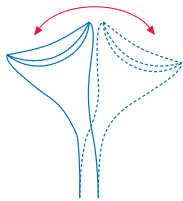

20 cm - 8"  
**Marberger**

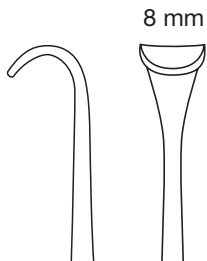

**51.57.08**  
# 1

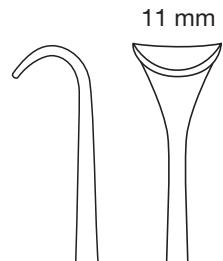

**51.57.11**  
# 2

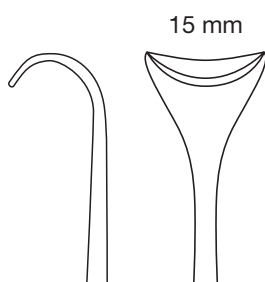

**51.57.15**  
# 3

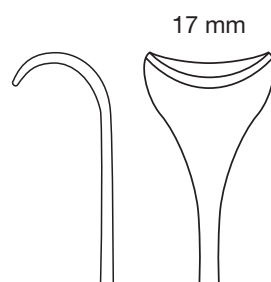

**51.57.17**  
# 4

**Wund- und Gefäßhäkchen**  
**Wound and Vessel Retractors**  
**Separadores y ganchos para vasos**  
**Ecarteurs et crochets pour vaisseaux**  
**Uncinetti e divaricatori per vasi**



11



24 cm - 9½"  
**Gil-Vernet**

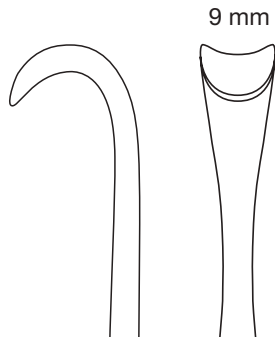

**51.57.89**

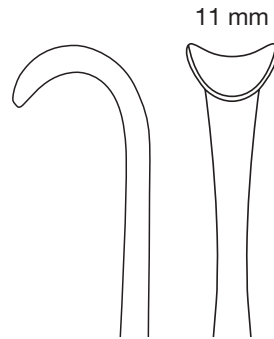

**51.57.91**

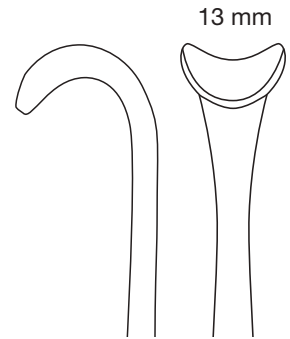

**51.57.93**

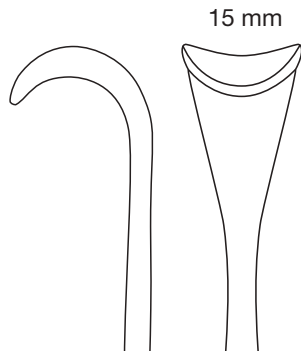

**51.57.95**

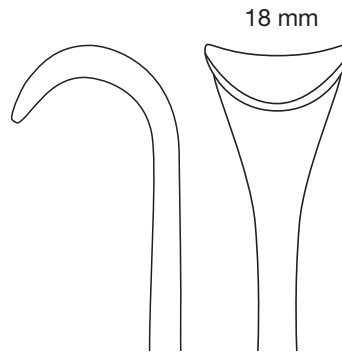

**51.57.98**



**Wund- und Gefäßhäkchen**  
**Wound and Vessel Retractors**  
**Separadores y ganchos para vasos**  
**Ecarteurs et crochets pour vaisseaux**  
**Uncinetti e divaricatori per vasi**

11

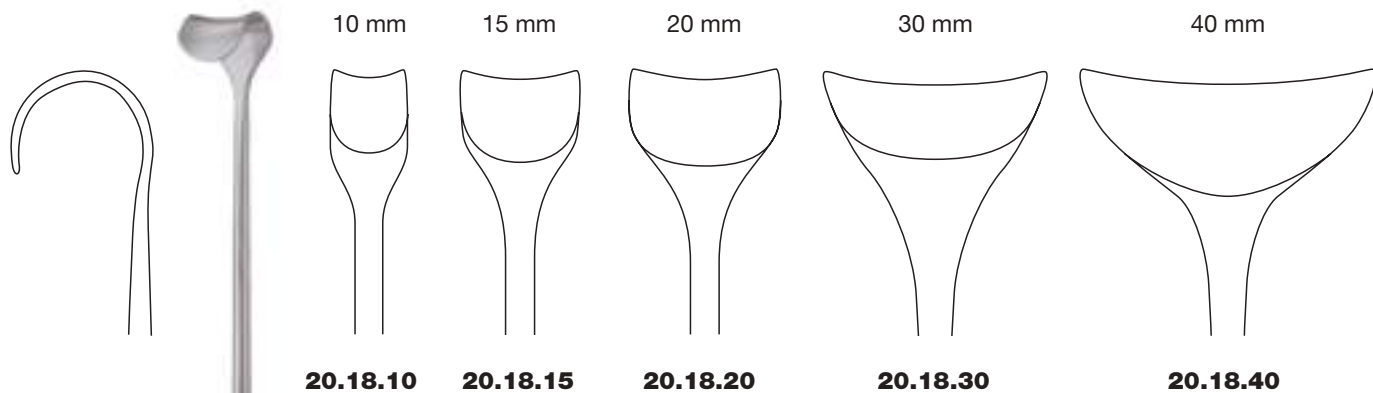

25 cm – 10"  
**Love (Morse)**



Venenhaken  
 Vein retractor  
 Gancho para venas  
 Ecarteur à veines  
 Divaricatore per vene

**20.17.50**  
 23 cm – 9"  
**Cushing**



**20.17.90**  
 20 cm – 8"  
**Schoenborn**



**23.03.06**  
 19,5 cm – 7¾"  
**Lahey**

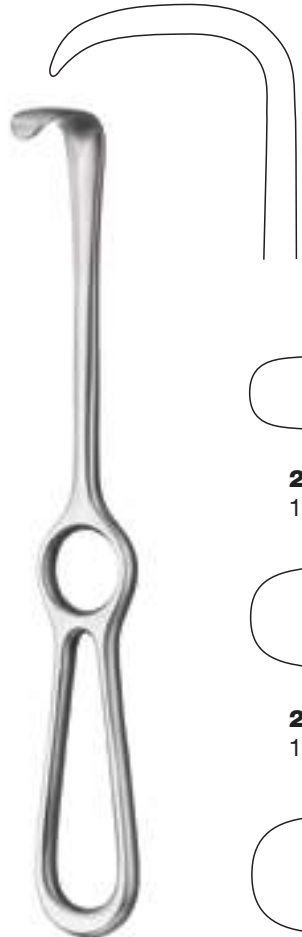

21 cm – 8¼"  
**Langenbeck**



**23.05.10**  
 10 x 28 mm



**23.05.14**  
 14 x 28 mm

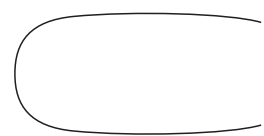

**23.05.16**  
 16 x 28 mm





**Wundhaken  
Retractors  
Separadores  
Ecarteurs  
Divaricatori**

11



21 cm - 8 1/4"  
**Langenbeck**

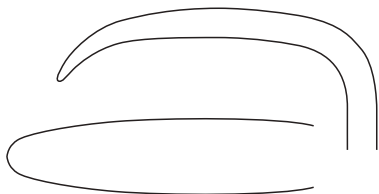

**23.06.10**  
10 x 40 mm



**23.06.12**  
14 x 33 mm

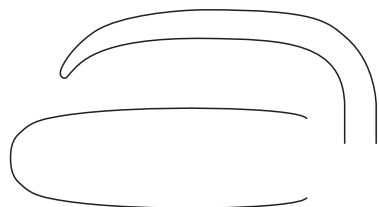

**23.06.13**  
13 x 42 mm

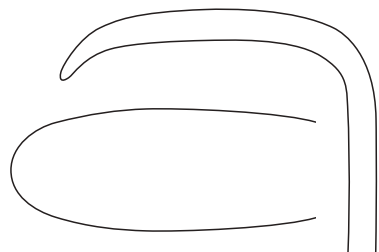

**23.06.16**  
16 x 42 mm



21 cm - 8 1/4"  
**Langenbeck**

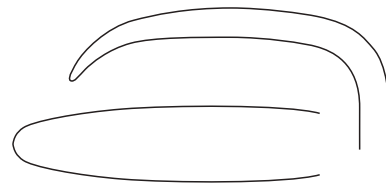

**23.07.10**  
10 x 40 mm

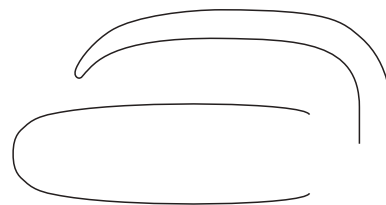

**23.07.13**  
13 x 42 mm

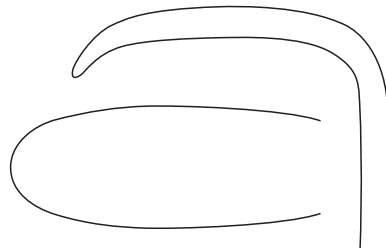

**23.07.16**  
16 x 42 mm



**23.08.55**  
20 x 55 mm

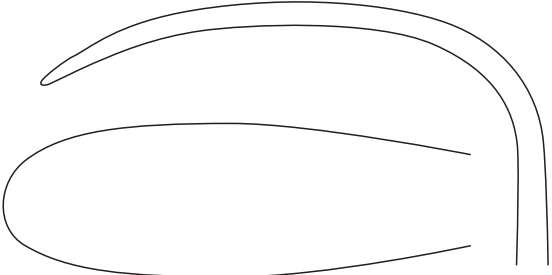
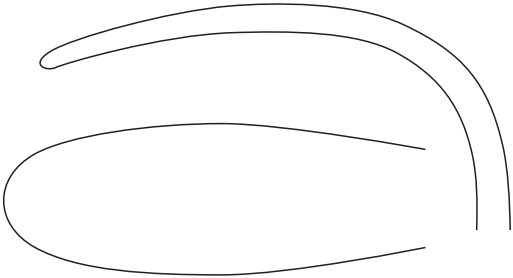

**23.08.63**  
20 x 63 mm

21 cm - 8 1/4"  
**Langenbeck**

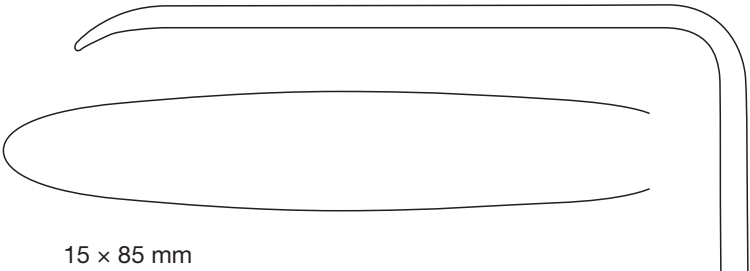

15 x 85 mm



**23.08.85**  
21 cm - 8 1/4"  
**Langenbeck**

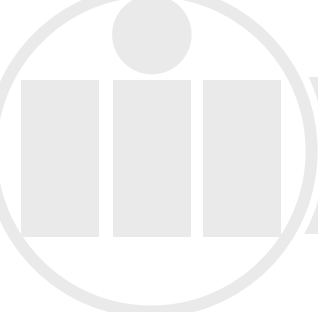

**Wundhaken  
Retractors  
Separadores  
Ecarteurs  
Divaricatori**

11



21 cm – 8¼"  
**Langenbeck-  
Kocher**



**23.25.01**  
7 x 20 mm



**23.25.04**    **23.25.02**  
15 x 30 mm    7 x 30 mm

**23.25.05**    **23.25.03**  
20 x 30 mm    10 x 30 mm

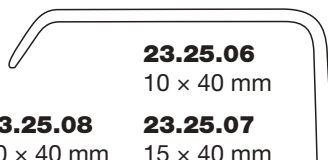

**23.25.06**  
10 x 40 mm

**23.25.08**    **23.25.07**  
20 x 40 mm    15 x 40 mm

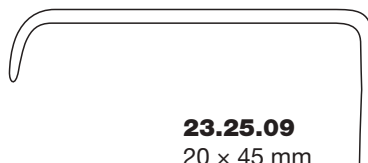

**23.25.09**  
20 x 45 mm

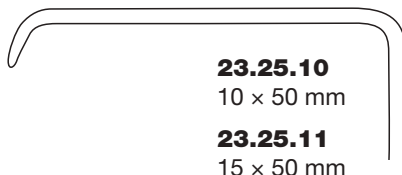

**23.25.10**  
10 x 50 mm

**23.25.11**  
15 x 50 mm

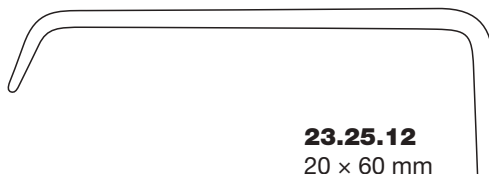

**23.25.12**  
20 x 60 mm



**23.25.13**  
15 x 80 mm

**23.25.14**  
20 x 80 mm



27 x 125 mm

**23.29.80**  
 29 cm – 11<sup>3</sup>/<sub>8</sub>"

35°

**23.29.75**  
 27,5 cm – 10<sup>3</sup>/<sub>4</sub>"

**23.29.60**  
 26 cm – 10<sup>1</sup>/<sub>4</sub>"

**23.29.35**  
 25 cm – 10"

**23.60.50**  
 25 cm – 10"  
**Sauerbruch**

**Zenker**



**Wundhaken  
Retractors  
Separadores  
Ecarteurs  
Divaricatori**

11

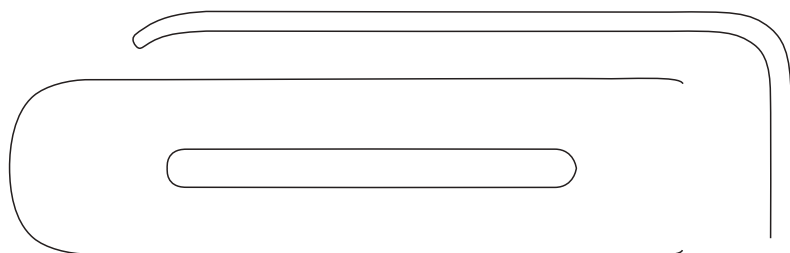

**23.61.01**  
23 x 85 mm



23 cm – 9"  
**Coryllos**

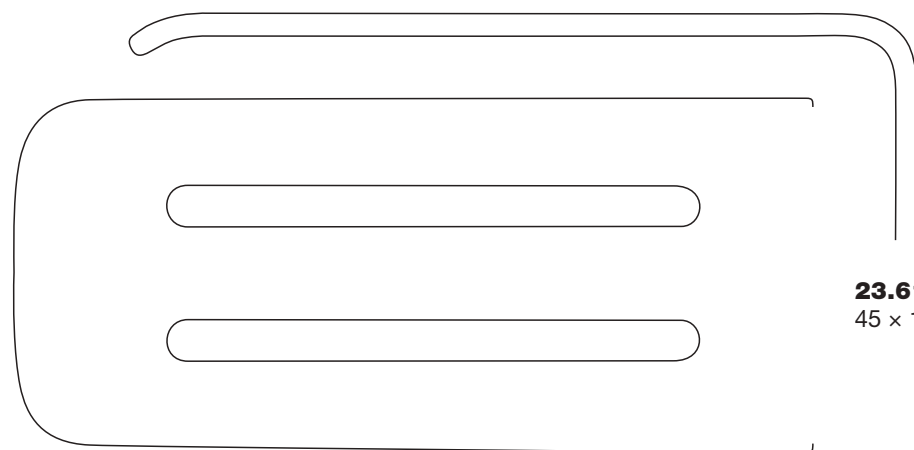

**23.61.02**  
45 x 105 mm

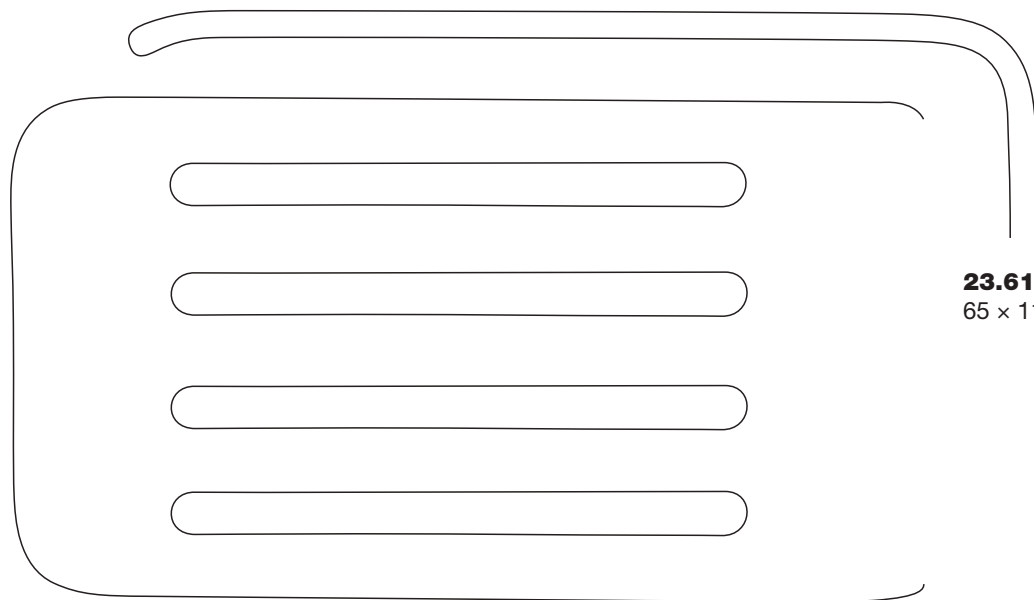

**23.61.03**  
65 x 115 mm





**Wundhaken  
Retractors  
Separadores  
Ecarteurs  
Divaricatori**

11



**23.69.15**  
50 × 155 mm

**23.69.12**  
50 × 120 mm

**23.69.08**  
35 × 85 mm



26 cm – 10¼"  
**Mikulicz**

**Wundhaken und Lungenspatel**  
**Retractors and Lung Spatulas**  
**Separadores y espátulas para pulmones**  
**Ecarteurs et spatules pulmonaires**  
**Divaricatori e spatole per polmoni**

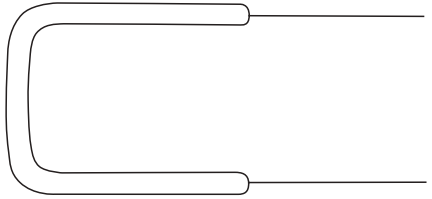

24 x 70 mm

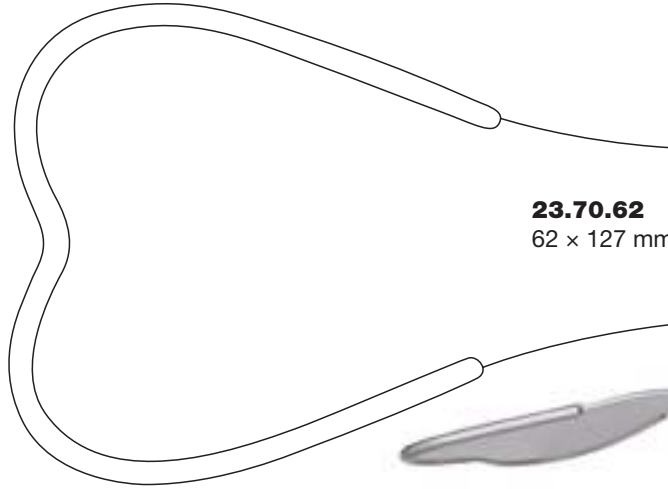

**23.70.62**  
62 x 127 mm



**23.70.24**  
25 cm - 10"  
**Harrington-Baby**

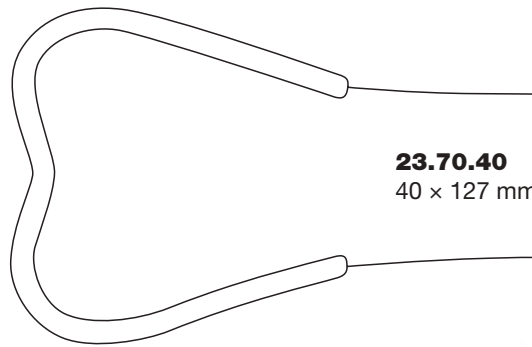

**23.70.40**  
40 x 127 mm



32 cm - 12½"  
**Harrington**

11





**Wundhaken und Lungenspatel**  
**Retractors and Lung Spatulas**  
**Separadores y espátulas para pulmones**  
**Ecarteurs et spatules pulmonaires**  
**Divaricatori e spatole per polmoni**

11

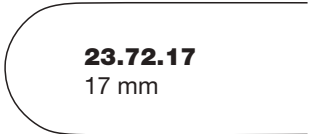
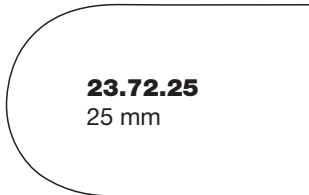
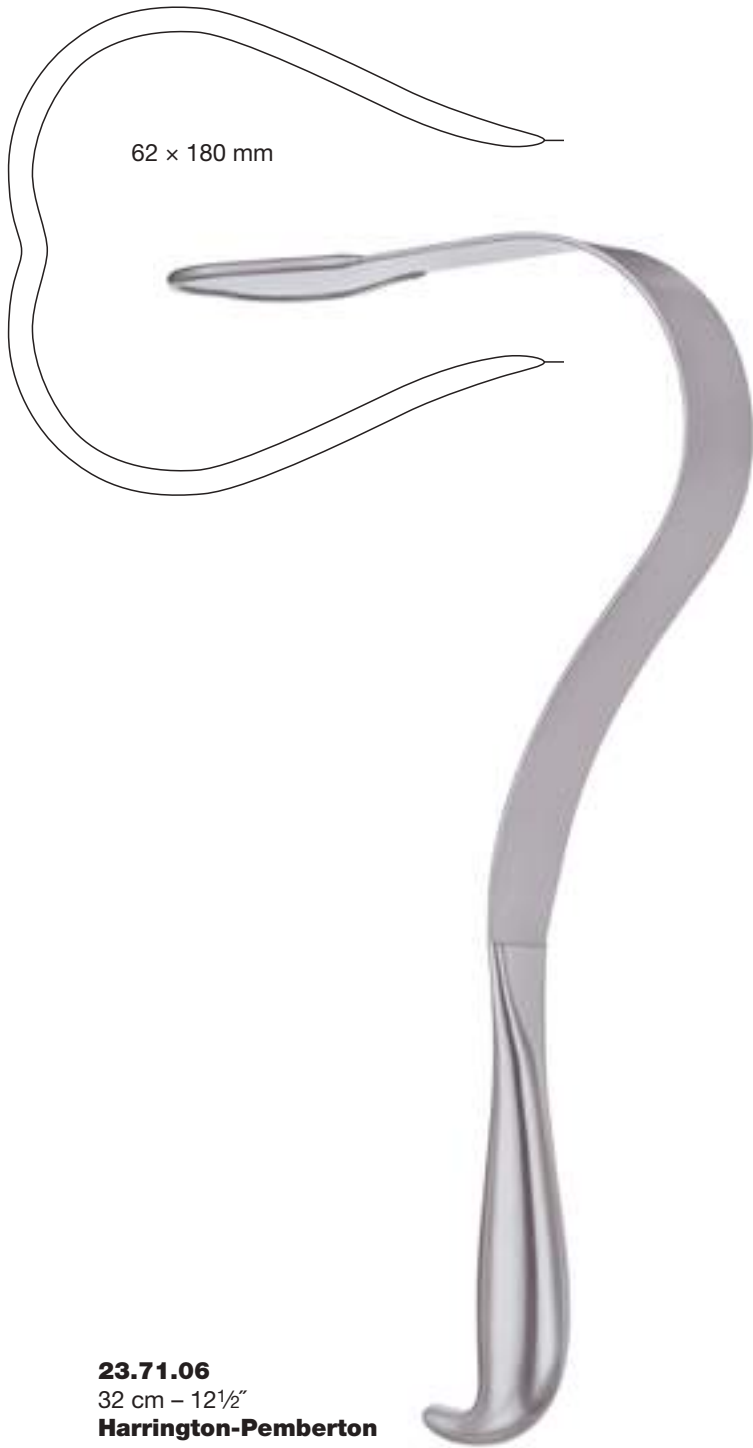

**Wundhaken und Lungenspatel**  
**Retractors and Lung Spatulas**  
**Separadores y espátulas para pulmones**  
**Ecarteurs et spatules pulmonaires**  
**Divaricatori e spatole per polmoni**



32 cm – 12½”  
**Deaver**

**23.73.25**  
25 mm

**23.73.35**  
35 mm

**23.73.50**  
50 mm

**23.73.75**  
75 mm

11



**Wundhaken und Lungenspatel**  
**Retractors and Lung Spatulas**  
**Separadores y espátulas para pulmones**  
**Ecarteurs et spatules pulmonaires**  
**Divaricatori e spatole per polmoni**

11

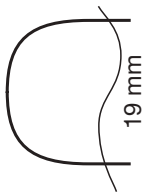

**23.75.01**  
# 000  
18 cm – 7 $\frac{1}{8}$ "  
**Deaver**

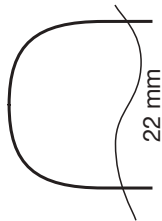

**23.75.02**  
# 00  
22 cm – 8 $\frac{3}{4}$ "  
**Deaver**

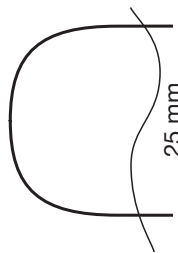

**23.75.03**  
# 0  
23 cm – 9"  
**Deaver**

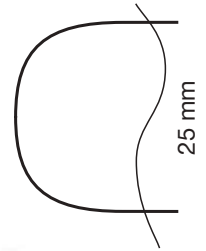

**23.75.04**  
# 1  
30 cm – 11 $\frac{3}{4}$ "  
**Deaver**

**Wundhaken und Lungenspatel**  
**Retractors and Lung Spatulas**  
**Separadores y espátulas para pulmones**  
**Ecarteurs et spatules pulmonaires**  
**Divaricatori e spatole per polmoni**



11

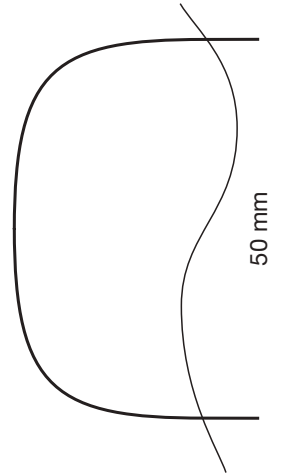
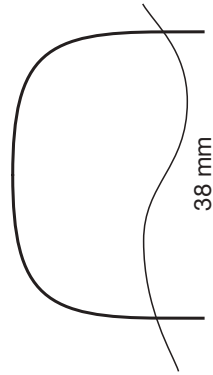
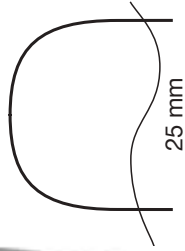
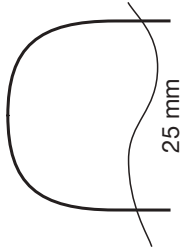

**23.75.05**  
# 2  
33 cm – 13"  
**Deaver**



**23.75.06**  
# 2½  
35 cm – 13¾"  
**Deaver**



**23.75.07**  
# 3  
30 cm – 11¾"  
**Deaver**



**23.75.08**  
# 4  
30 cm – 11¾"  
**Deaver**



**Wundhaken und Lungenspatel**  
**Retractors and Lung Spatulas**  
**Separadores y espátulas para pulmones**  
**Ecarteurs et spatules pulmonaires**  
**Divaricatori e spatole per polmoni**

11



75 mm

**23.75.09**  
# 5  
30 cm – 11<sup>3</sup>/<sub>4</sub>"  
**Deaver**

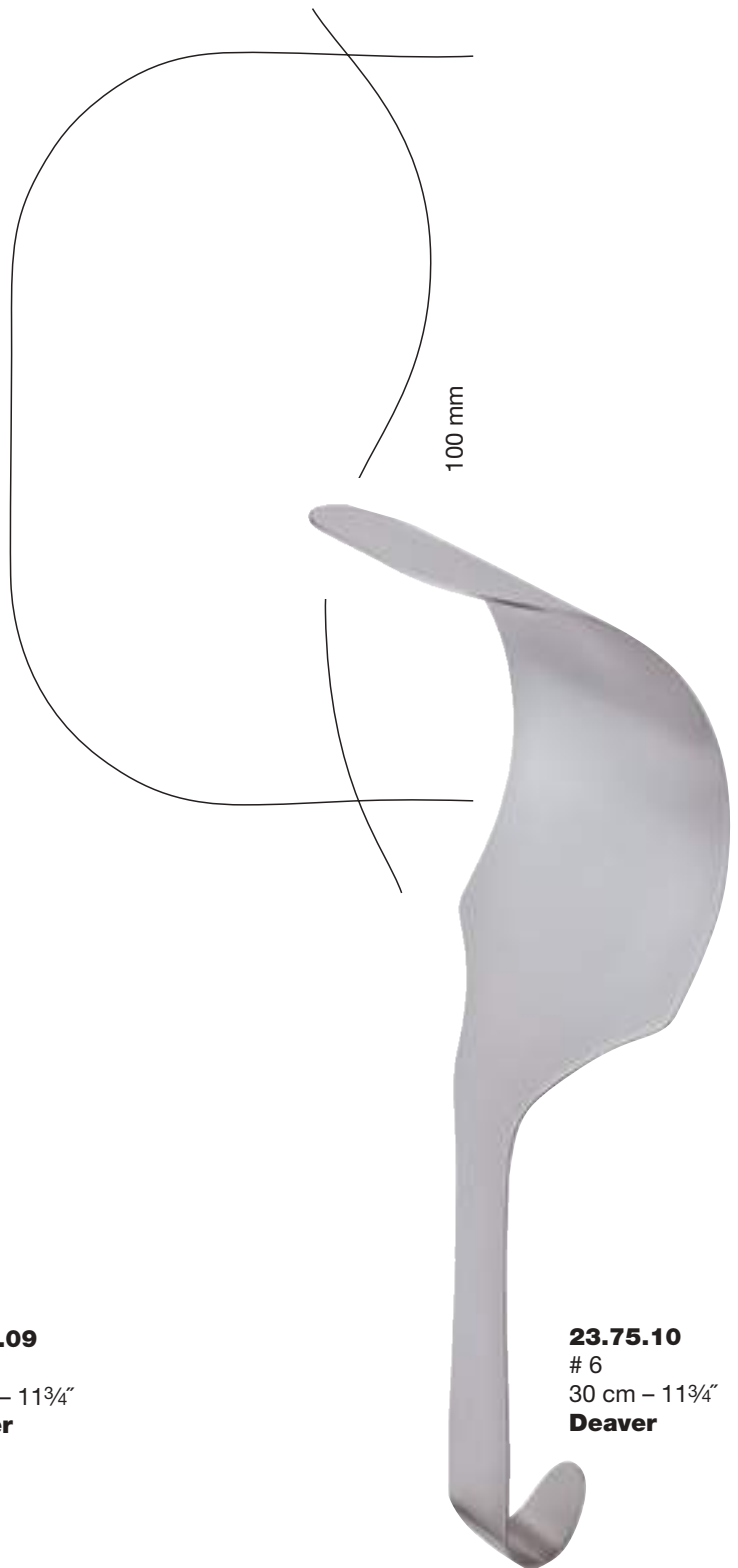

100 mm

**23.75.10**  
# 6  
30 cm – 11<sup>3</sup>/<sub>4</sub>"  
**Deaver**

**Wundhaken und Lungenspatel**  
**Retractors and Lung Spatulas**  
**Separadores y espátulas para pulmones**  
**Ecarteurs et spatules pulmonaires**  
**Divaricatori e spatole per polmoni**



11



27 cm – 10¾"  
**Kader**

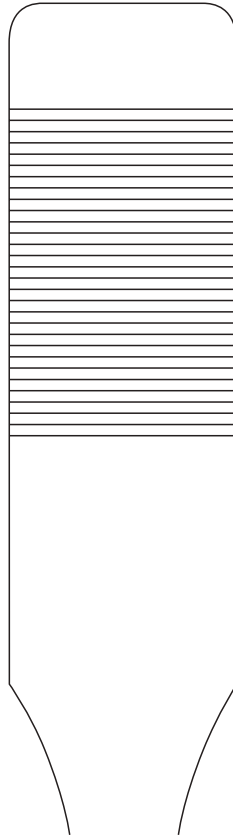

**23.80.03**  
30 mm

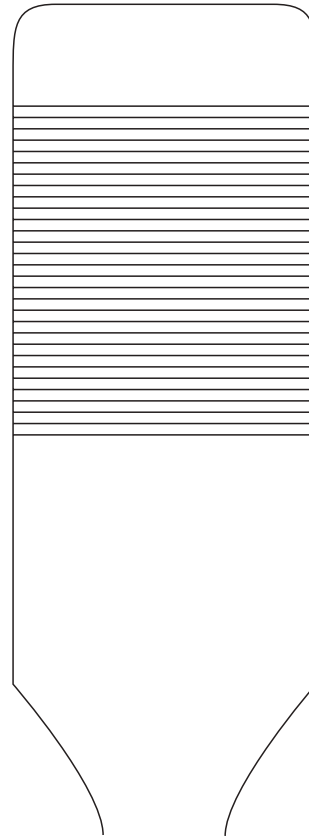

**23.80.04**  
40 mm



**Lungenspatel**  
**Lung Spatulas**  
**Espátulas para pulmones**  
**Spatules pulmonaires**  
**Spatole per polmoni**

11



**54.35.05**  
27 cm – 10<sup>3</sup>/<sub>4</sub>"  
a = 40 mm  
**Allison**

**54.35.10**  
32 cm – 12<sup>1</sup>/<sub>2</sub>"  
a = 65 mm  
**Allison**

132 mm



**54.35.15**  
26 cm – 10<sup>1</sup>/<sub>4</sub>"

**Lungenhaken, Skapulahaken, Aortahaken**  
**Lung Retractors, Scapular Retractors, Aorta Retractors**  
**Espátulas para pulmones, Espátulas para scapula, Separadores para aorta**  
**Ecarteurs pulmonaire, Ecarteurs scapulaires, Ecarteurs pour l'aorte**  
**Divaricatori per polmoni, scapola, aorta**

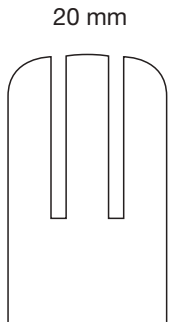

20 mm

**54.35.20**  
# 1

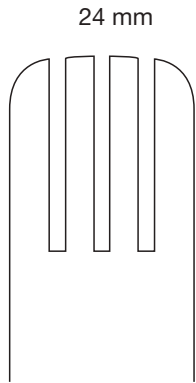

24 mm

**54.35.24**  
# 2



25 cm – 10"  
**Semb**



**Davidson**

**54.35.50**  
a = 50 mm  
b = 75 mm

**54.35.90**  
a = 90 mm  
b = 75 mm



15 mm

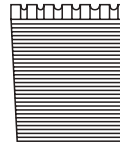

**55.11.34**

23 mm

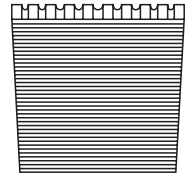

**55.11.36**

19 cm – 10½"  
**Crawford**





**Atriumhaken**  
**Atrium Retractors**  
**Separador para atrio**  
**Ecarteur pour oreillette**  
**Divaricatore per atrio**

11

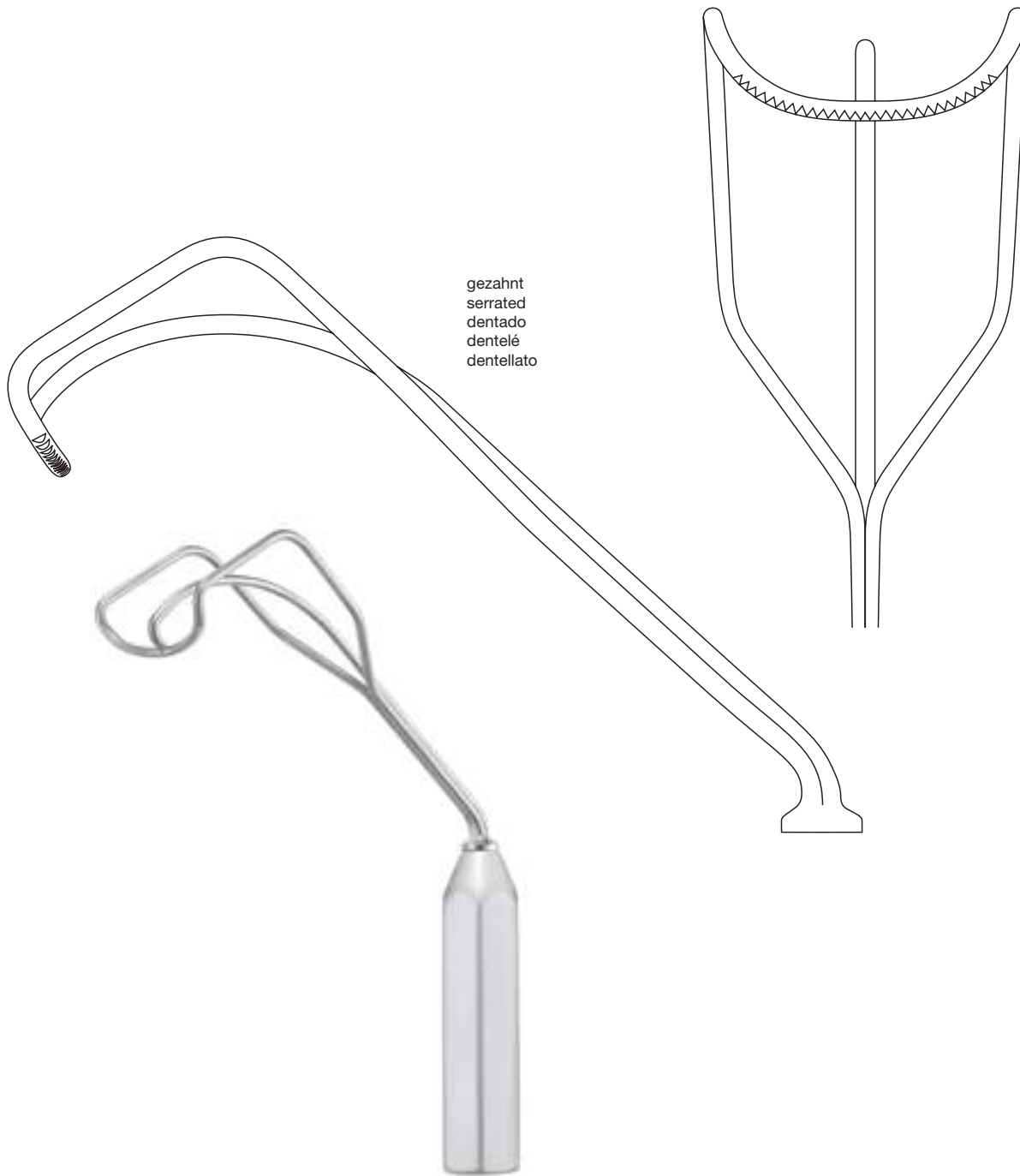

gezahnt  
serrated  
dentado  
dentelé  
dentellato

**55.11.10**  
21,5 cm – 8½"  
**Cooley**

**Atriumhaken**  
**Atrium Retractors**  
**Separador para atrio**  
**Ecarteur pour oreillette**  
**Divaricatore per atrio**

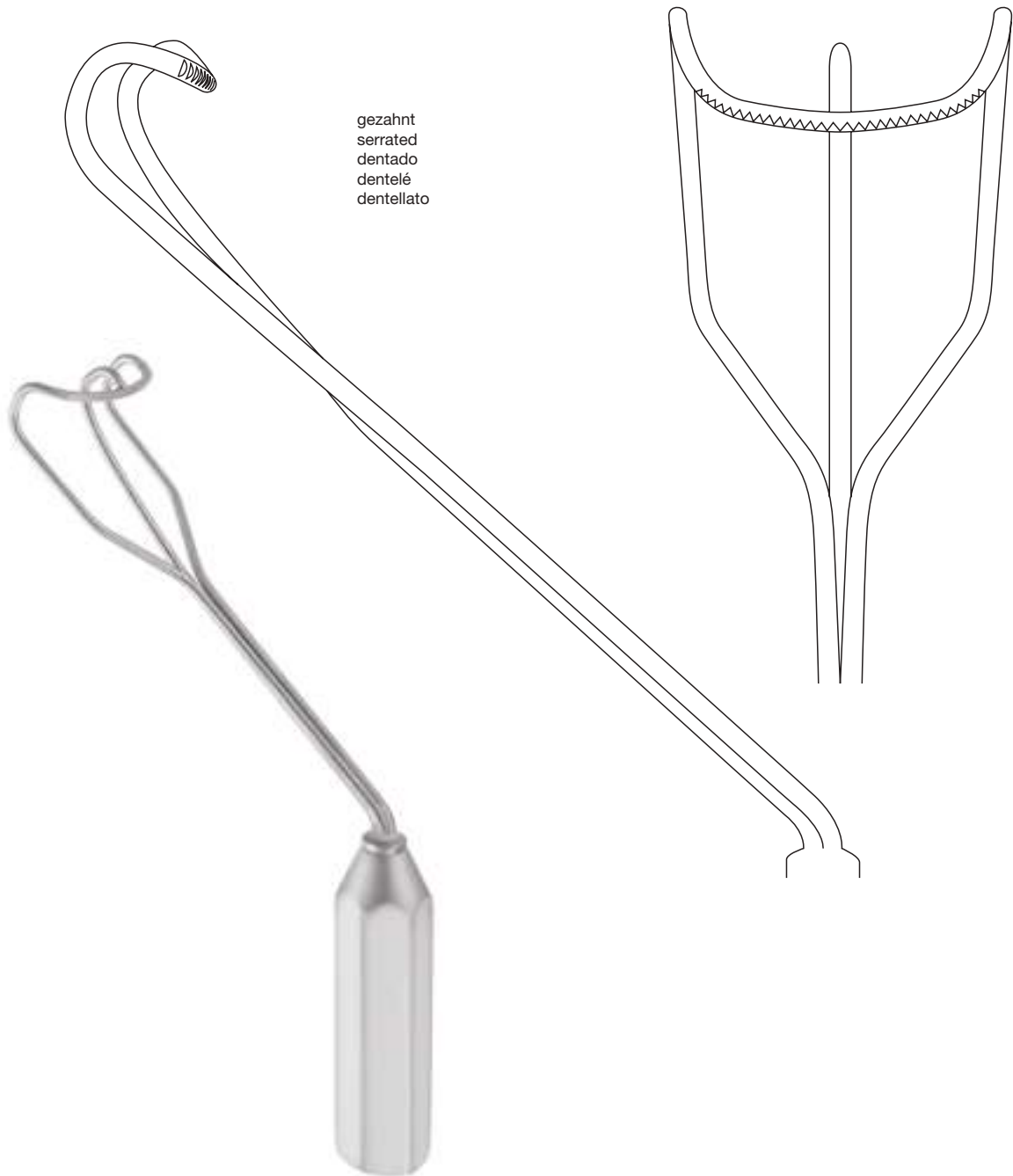

gezahnt  
serrated  
dentado  
dentelé  
dentellato

11

**55.11.11**  
23 cm – 9"  
**Cooley**



**Atriumhaken**  
**Atrium Retractors**  
**Separadores para atrio**  
**Ecarteurs pour oreillette**  
**Divaricatori per atrio**

11

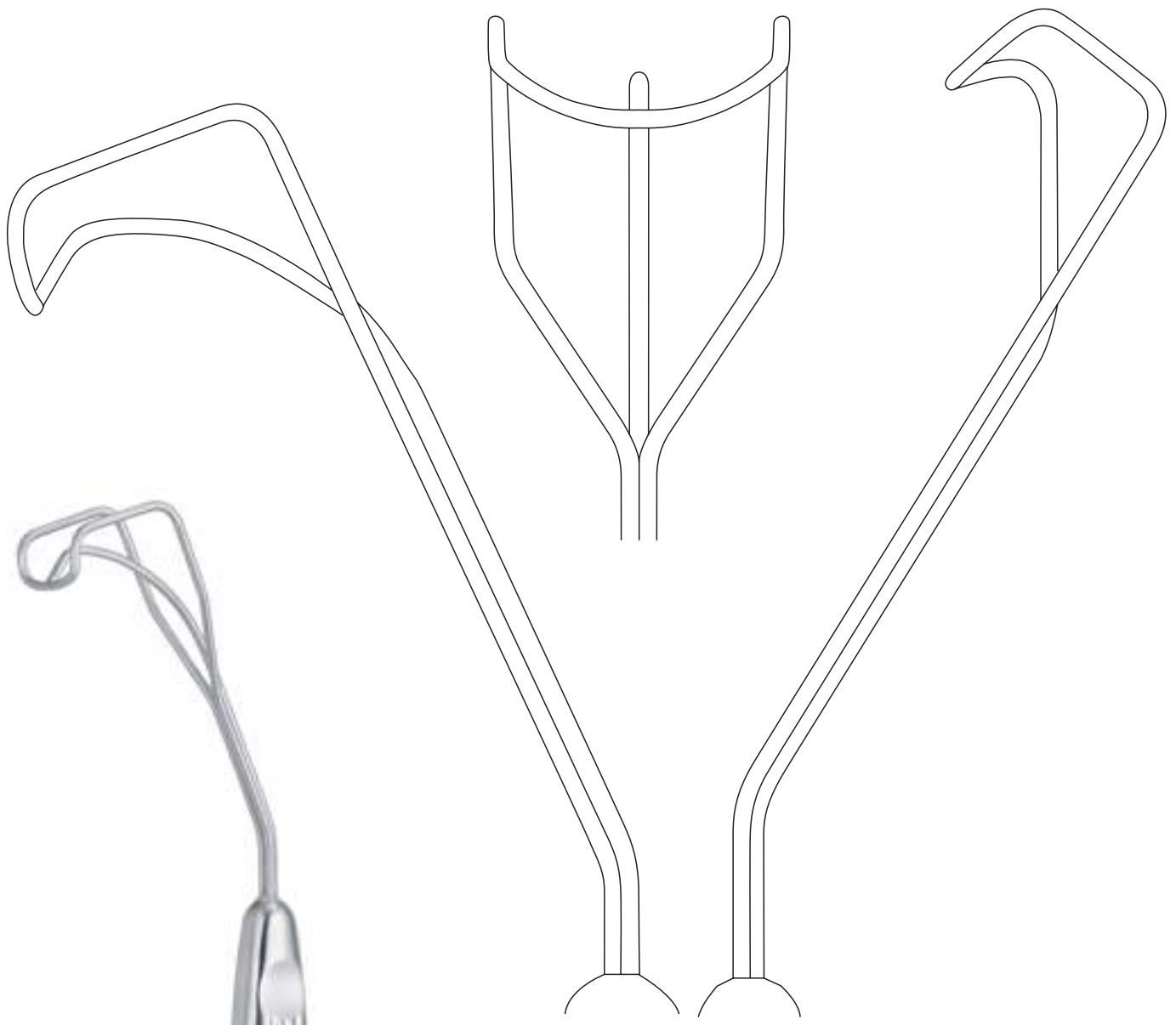

55.11.12

55.11.13

27 cm – 10<sup>3</sup>/<sub>4</sub>"  
**Cooley**

**Atriumhaken**  
**Atrium Retractors**  
**Separadores para atrio**  
**Ecarteurs pour oreillette**  
**Divaricatori per atrio**



gezahnt  
 serrated  
 dentado  
 dentelé  
 dentellato



**Cooley**

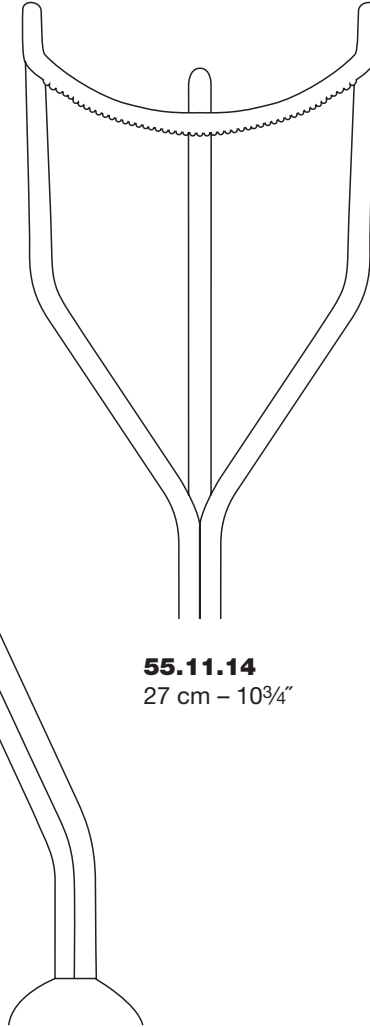

**55.11.14**  
 27 cm – 10<sup>3</sup>/<sub>4</sub>"

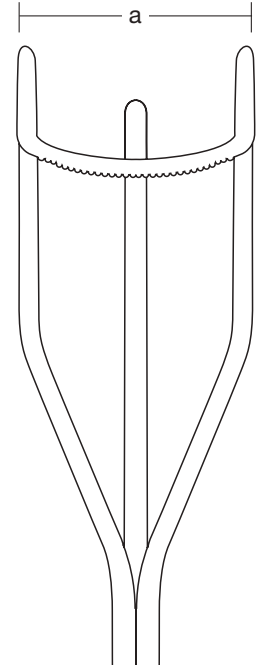

**55.11.15**  
 a = 30 mm  
 25 cm – 10"

**55.11.16**  
 a = 35 mm  
 25 cm – 10"



**Aortahaken**  
**Aorta Retractors**  
**Separadores para aorta**  
**Ecarteurs pour l'aorte**  
**Divaricatori per aorta**

11



25,5 cm - 10"  
**Ross**

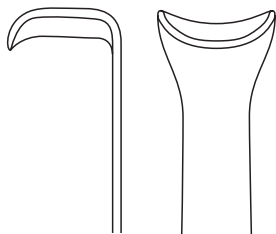

**55.11.27**

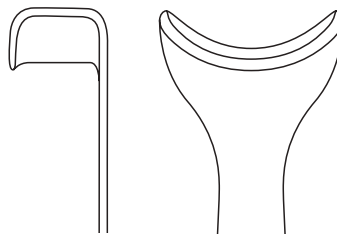

**55.11.28**

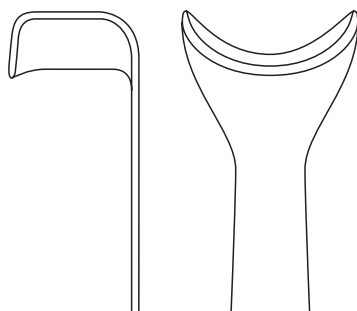

**55.11.29**

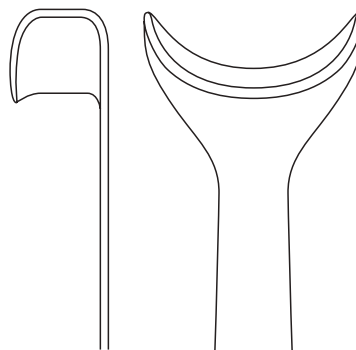

**55.11.30**

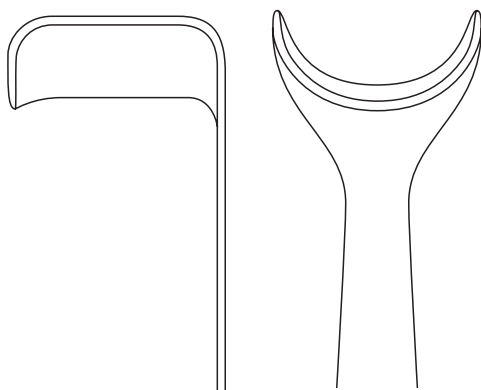

**55.11.31**

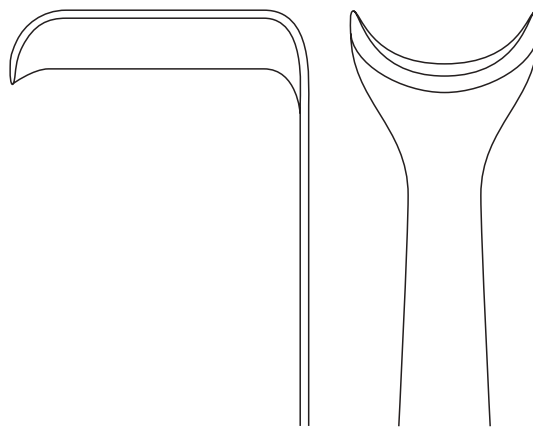

**55.11.32**

medicon

**Wundspreizer**  
**Self-retaining Retractors**  
**Separadores autoestáticos**  
**Ecarteurs autostatiques**  
**Divaricatori autostatici**



**Wundspreizer**  
**Self-retaining Retractors**  
**Separadores autoestáticos**  
**Ecarteurs autostatiques**  
**Divaricatori autostatici**

12

6 mm



scharf  
sharp  
agudo  
pointu  
acuto

**24.09.09**

10 cm – 4"  
**Medicon**

stumpf  
blunt  
romo  
mousse  
smusso

**24.09.10**

5 mm



scharf  
sharp  
agudo  
pointu  
acuto

**24.10.07**

7 cm – 2¾"  
**Alm**

stumpf  
blunt  
romo  
mousse  
smusso

**24.10.08**

6 mm



scharf  
sharp  
agudo  
pointu  
acuto

**24.10.10**

10 cm – 4"  
**Alm**

stumpf  
blunt  
romo  
mousse  
smusso

**24.10.11**

**Epikardialspreizer**  
**Epicardial retractor**  
**Separador epicardiaco**  
**Ecarteur épicardique**  
**Divaricatore epicardiaco**



scharf  
sharp  
agudo  
pointu  
acuto

**24.03.07**  
 5 cm – 2"

16 mm



scharf  
sharp  
agudo  
pointu  
acuto

**24.22.13**

13 cm – 5 1/8"  
**Weitlaner**

stumpf  
blunt  
romo  
mousse  
smusso

**24.22.14**

halbscharf  
semi sharp  
semi agudo  
semi pointu  
semi acuto

**24.22.15**

16 mm

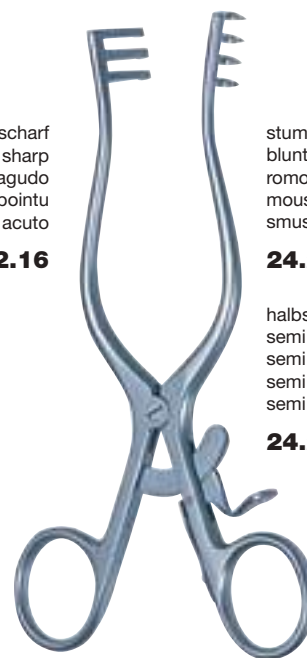

scharf  
sharp  
agudo  
pointu  
acuto

**24.22.16**

16,5 cm – 6 1/2"  
**Weitlaner**

stumpf  
blunt  
romo  
mousse  
smusso

**24.22.17**

halbscharf  
semi sharp  
semi agudo  
semi pointu  
semi acuto

**24.22.18**

**Wundspreizer  
Self-retaining Retractors  
Separadores autoestáticos  
Ecarteurs autostatiques  
Divaricatori autostatici**

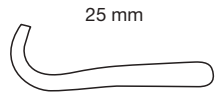

scharf  
sharp  
agudo  
pointu  
acuto

**24.22.24**

stumpf  
blunt  
romo  
mousse  
smusso

**24.22.25**

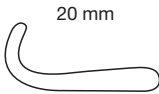

scharf  
sharp  
agudo  
pointu  
acuto

**24.22.20**

stumpf  
blunt  
romo  
mousse  
smusso

**24.22.21**



20 cm - 8"  
**Weitlaner**



24 cm - 9 1/2"  
**Weitlaner**

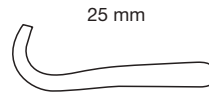

scharf  
sharp  
agudo  
pointu  
acuto

**24.22.26**

stumpf  
blunt  
romo  
mousse  
smusso

**24.22.27**



24 cm - 9 1/2"  
**Weitlaner**





**Wundspreizer**  
**Self-retaining Retractors**  
**Separadores autoestáticos**  
**Ecarteurs autostatiques**  
**Divaricatori autostatici**

12

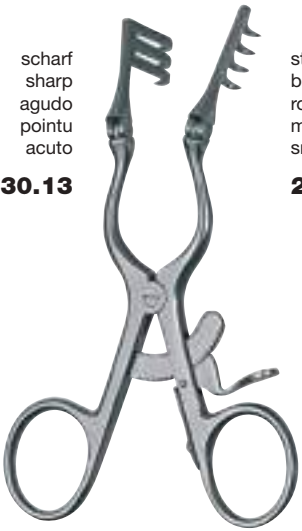
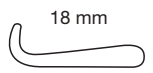

scharf  
sharp  
agudo  
pointu  
acuto

**24.30.13**

14,5 cm – 5<sup>3</sup>/<sub>8</sub>"  
**Weitlaner-Beckmann**

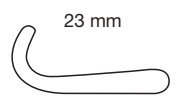

scharf  
sharp  
agudo  
pointu  
acuto

**24.30.20**

22 cm – 8<sup>3</sup>/<sub>4</sub>"  
**Weitlaner-Beckmann**

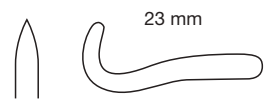

scharf  
sharp  
agudo  
pointu  
acuto

**24.32.04**  
 31 cm – 12<sup>1</sup>/<sub>8</sub>"  
**Beckmann**

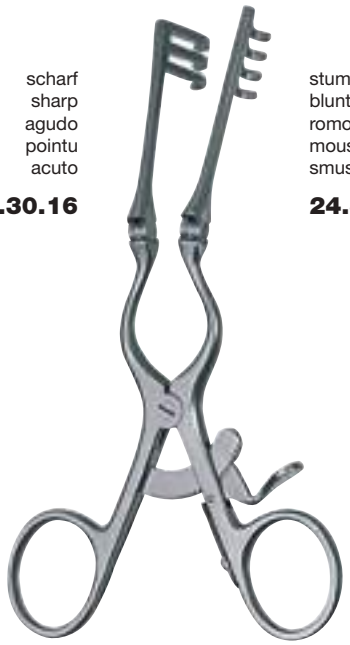
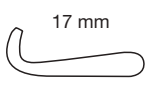

scharf  
sharp  
agudo  
pointu  
acuto

**24.30.16**

17 cm – 6<sup>3</sup>/<sub>4</sub>"  
**Weitlaner-Beckmann**

stumpf  
blunt  
romo  
mousse  
smusso

**24.30.17**

**Wundspreizer**  
**Self-retaining Retractors**  
**Separadores autoestáticos**  
**Ecarteurs autostatiques**  
**Divaricatori autostatici**



12

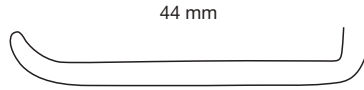

44 mm

**24.34.45**  
 scharf  
 sharp  
 agudo  
 pointu  
 acuto

**24.34.46**  
 stumpf  
 blunt  
 romo  
 mousse  
 smusso

**24.34.25**

**24.34.26**

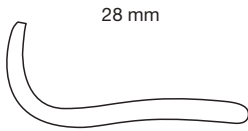

28 mm

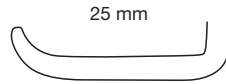

25 mm

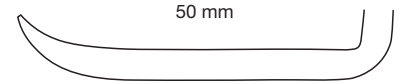

50 mm

stumpf  
 blunt  
 romo  
 mousse  
 smusso



**24.32.06**  
 32,5 cm – 12<sup>3</sup>/<sub>4</sub>"  
**Adson**

scharf  
 sharp  
 agudo  
 pointu  
 acuto



31 cm – 12<sup>1</sup>/<sub>8</sub>"  
**Beckmann-Adson**



**24.34.50**  
 32 cm – 12<sup>1</sup>/<sub>2</sub>"  
**Beckmann-Eaton**

Raspatorien  
Raspatories  
Legras  
Rugines  
Periostotomi



**Raspatorien  
Raspatories  
Legras  
Rugines  
Periostotomi**

13

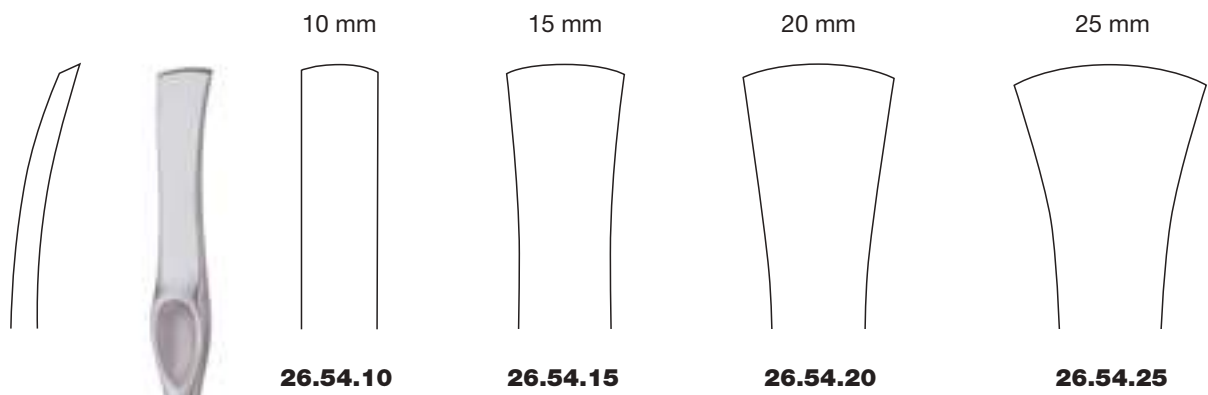

21 cm – 8¼"  
**Lambotte**

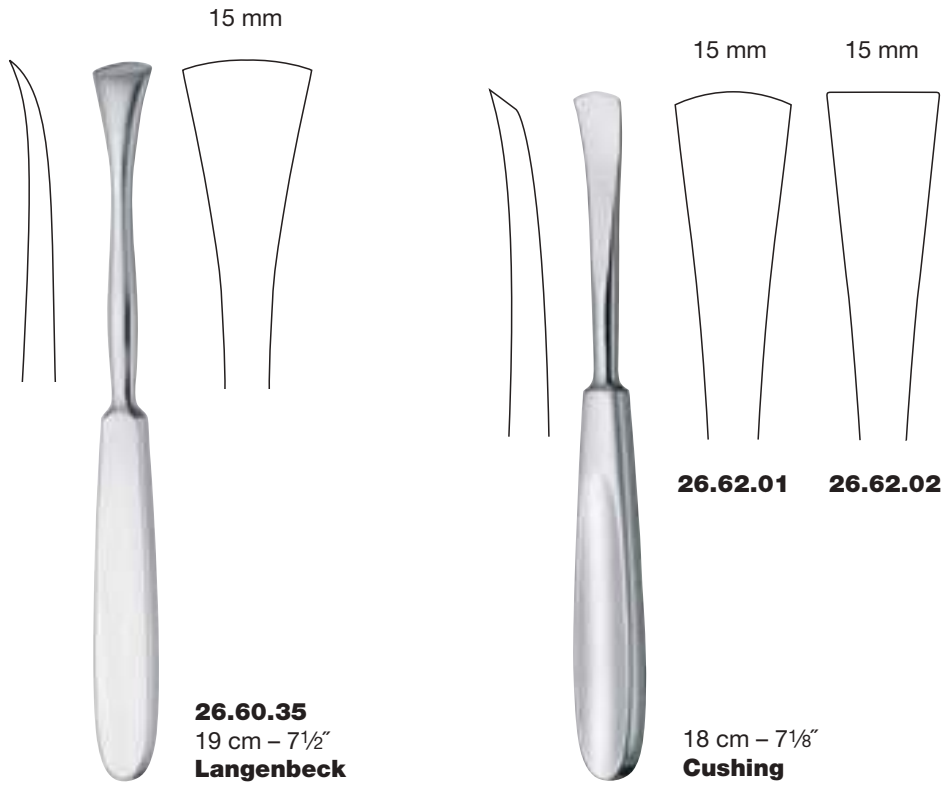



**26.76.01**  
20,5 cm – 8"  
**Semb**



**26.76.02**  
24 cm – 9½"  
**Semb**



**26.76.03**  
24 cm – 9½"  
**Semb**



**26.76.04**  
22 cm – 8¾"  
**Semb**



**26.76.07**  
22,5 cm – 9"  
**Semb**



**Raspatorien**  
**Raspatories**  
**Legras**  
**Rugines**  
**Periostotomi**

13



**54.31.30**  
22 cm – 8¾"  
**Matson**

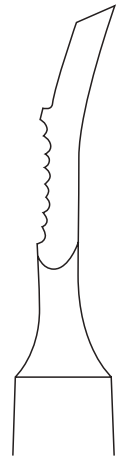
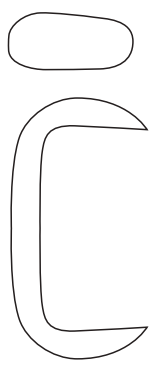

**54.31.35**  
22 cm – 8¾"  
**Alexander-Farabeuf**

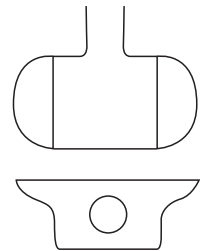
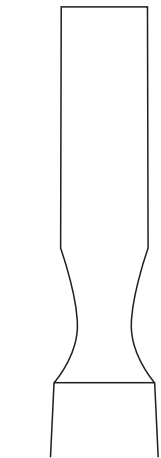



rechts  
right  
derecha  
à droite  
destro

links  
left  
izquierda  
à gauche  
sinistro

**54.30.01**  
14,5 cm – 5¾"  
**Doyen**

**54.30.02**  
14,5 cm – 5¾"  
**Doyen**

für Kinder  
for children  
para niños  
pour enfants  
per bambini

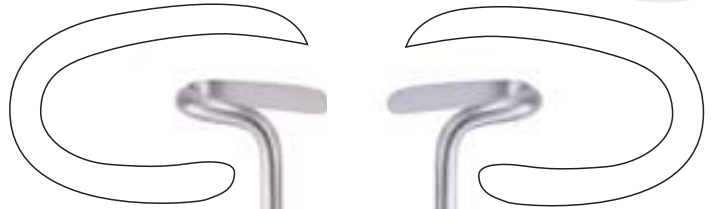

rechts  
right  
derecha  
à droite  
destro

links  
left  
izquierda  
à gauche  
sinistro

**54.30.21**  
24 cm – 9½"  
**Doyen**

**54.30.22**  
24 cm – 9½"  
**Doyen**



rechts  
right  
derecha  
à droite  
destro

links  
left  
izquierda  
à gauche  
sinistro

**54.30.11**  
17 cm – 6¾"  
**Doyen**

**54.30.12**  
17 cm – 6¾"  
**Doyen**



**Raspatorien**  
**Raspatories**  
**Legras**  
**Rugines**  
**Periostotomi**

13

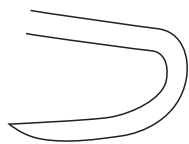

rechts  
right  
derecha  
à droite  
destro



**54.30.56**  
30 cm – 11<sup>3</sup>/<sub>4</sub>"  
**Obwegeser**



links  
left  
izquierda  
à gauche  
sinistro



**54.30.55**  
30 cm – 11<sup>3</sup>/<sub>4</sub>"  
**Obwegeser**



Hohlmeißelzangen  
Knochensplitterzangen

Bone Rongeurs  
Bone Cutting Forceps

Pinzas-gubias  
Pinzas cortantes para huesos

Pinces-gouges  
Pinces coupantes à os

Pinze-sgorbie  
Pinze ossivore



**Hohlmeißelzangen**  
**Bone Rongeurs**  
**Pinzas-gubias**  
**Pinces-gouges**  
**Pinze-sgorbie**

14



23 cm – 9"  
**Smith-Petersen**

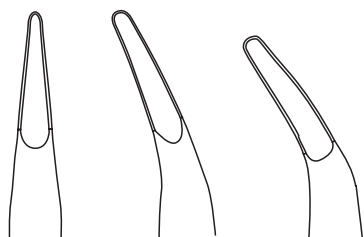

**31.09.03**    **31.09.13**    **31.09.23**



23 cm – 9"  
**Stille-Luer**

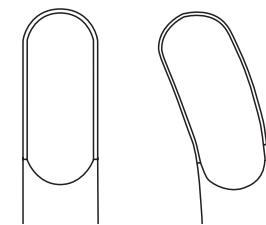

**31.30.23**    **31.31.23**



**Stille-Luer**

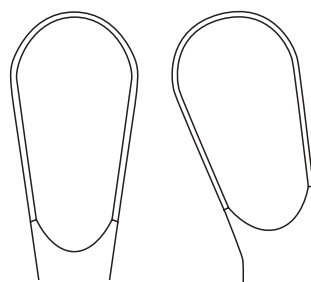

**31.30.24**    **31.31.24**  
 23 cm – 9"    23 cm – 9"

**31.30.27**    **31.31.27**  
 27 cm – 10¾"    27 cm – 10¾"

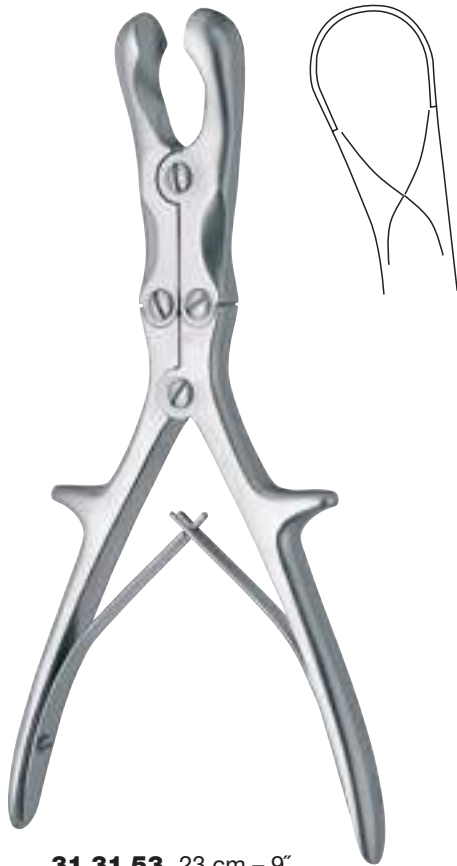

**31.31.53** 23 cm – 9"  
**31.31.57** 27 cm – 10<sup>3</sup>/<sub>4</sub>"  
**Semb-Stille**



**31.31.83**  
23 cm – 9"  
**Stille**



**Hohlmeißelzangen**  
**Bone Rongeurs**  
**Pinzas-gubias**  
**Pinces-gouges**  
**Pinze-sgorbie**

14



23 cm - 9"  
**Leksell**



**31.51.05**

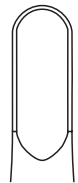

**31.51.08**



23 cm - 9"  
**Leksell**

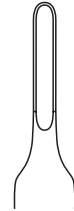

**31.53.03**

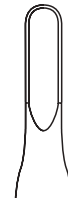

**31.53.05**

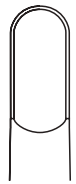

**31.53.08**

Hohlmeißelzangen  
Bone Rongeurs  
Pinzas-gubias  
Pinces-gouges  
Pinze-sgorbie



14



23 cm - 9"  
**Echlin**



**31.61.02**

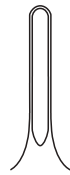

**31.61.03**

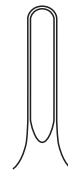

**31.61.04**



**31.61.36**  
36 cm - 14 1/8"  
**Syvert**



**Knochensplitterzangen**  
**Bone Cutting Forceps**  
**Pinzas cortantes para huesos**  
**Pinces coupantes à os**  
**Pinze ossivore**

14



**Liston**



**33.20.14**  
14 cm - 5½"



**33.20.17**  
17 cm - 6¾"



**33.20.19**  
19 cm - 7½"



**33.20.22**  
22 cm - 8¾"



**Liston**



**33.21.14**  
14 cm - 5½"



**33.21.17**  
17 cm - 6¾"



**33.21.19**  
19 cm - 7½"



**33.21.22**  
22 cm - 8¾"

**Knochensplitterzangen**  
**Bone Cutting Forceps**  
**Pinzas cortantes para huesos**  
**Pinces coupantes à os**  
**Pinze ossivore**



**33.02.15**  
 15 cm - 6"  
**Littauer**

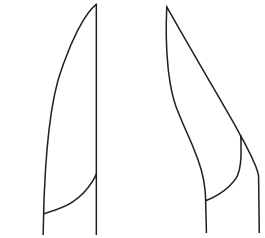

**33.56.18**      **33.57.18**

18 cm - 7 1/8"  
**Ruskin-Liston**

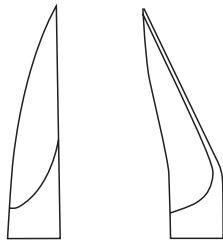

**33.58.18**      **33.59.18**

18 cm - 7 1/8"  
**McIndoe**



**33.59.17**  
 18 cm - 7 1/8"  
**McIndoe**



**Knochensplitterzangen**  
**Bone Cutting Forceps**  
**Pinzas cortantes para huesos**  
**Pinces coupantes à os**  
**Pinze ossivore**

14



**33.70.27**

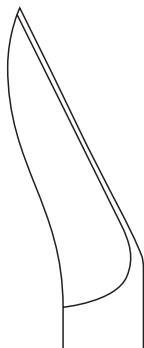

**33.71.27**

27 cm – 10 $\frac{3}{4}$ "  
**Liston-Stille**

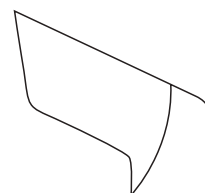

**33.75.27**  
27 cm – 10 $\frac{3}{4}$ "  
**Liston-Key**



**Knochenhalte­zangen · Rippenscheren**  
**Bone Holding Forceps · Rib Shears**  
**Pinzas prensoras de huesos · Costótomos**  
**Daviers à os · Costotomes**  
**Tenaglie per ossa · Costotomi**



**Knochenhaltezangen**  
**Bone Holding Forceps**  
**Pinzas para huesos**  
**Daviers à os**  
**Tenaglie per ossa**

15



**35.15.18**  
19 cm – 7½"  
**Dingmann**



**35.15.19**  
19 cm – 7½"  
**Dingmann**



**35.20.20**  
20 cm – 8"

**Knochenhaltezangen**  
**Bone Holding Forceps**  
**Pinzas para huesos**  
**Daviers à os**  
**Tenaglie per ossa**



15



**35.24.20**  
 20 cm – 8"  
**Semb**

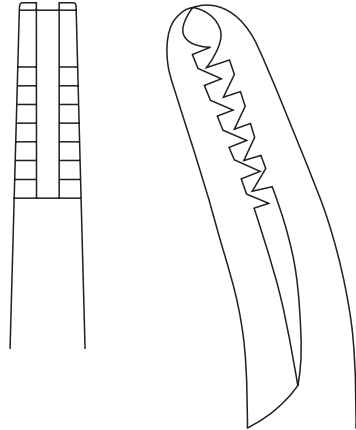

**35.25.20**  
 20 cm – 8"  
**Semb**

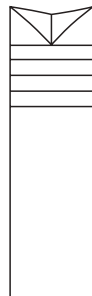

**35.50.21**  
 20 cm – 8"  
**Langenbeck**



**35.52.21**  
 21 cm – 8¼"  
**Fergusson**

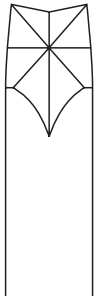



**Rippenscheren**  
**Rib Shears**  
**Costótomos**  
**Costotomes**  
**Costotomi**

rechts  
right  
derecho  
à droite  
destro



**54.12.51**  
30 cm – 11¾"  
**Coryllos-Bethune**  
**(Collin)**

links  
left  
izquierdo  
à gauche  
sinistro



**54.12.52**  
30 cm – 11¾"  
**Coryllos-Bethune**  
**(Collin)**

15



**54.10.19**  
19 cm – 7½"  
**Gluck**



**54.10.22**  
22 cm – 8¾"  
**Bethune**



**54.12.34**  
34 cm – 13¾"  
**Bethune**



**Rippenscheren**  
**Rib Shears**  
**Costótomos**  
**Costotomes**  
**Costotomi**

15

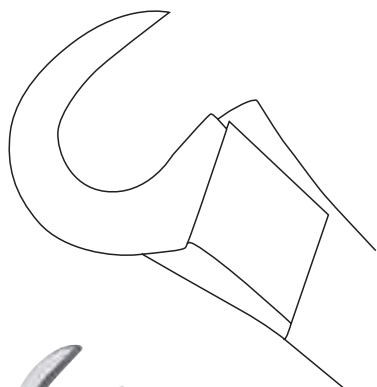

**54.15.25**  
25 cm – 10"  
**Giertz**

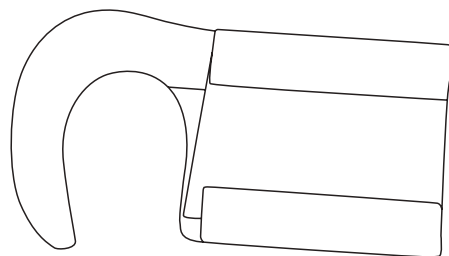

**54.17.26**  
26 cm – 10¼"  
**Sauerbruch**



links  
left  
izquierdo  
à gauche  
sinistro



**54.15.01**  
# 1  
32 cm – 12½"  
**Brunner**

rechts  
right  
derecho  
à droite  
destro



**54.15.02**  
# 2  
32 cm – 12½"  
**Brunner**

**Rippenspreizer  
Sternumspreizer**

**Rib Spreaders  
Sternal Retractors**

**Separadores para costillas  
Separadores para esternón**

**Ecarteurs costaux  
Ecarteurs pour sternum**

**Divaricatori costali  
Divaricatori sternali**





**Rippenspreizer, Rippenkontraktoren**  
**Rib Spreaders, Rib Contractors**  
**Separadores para costillas**  
**Ecarteurs costaux**  
**Divaricatori costali**

16



**54.25.10**  
20 cm – 8"  
**Sellers**



**54.25.20**  
17 cm – 6<sup>3</sup>/<sub>4</sub>"  
**Medicon**



**54.25.40**  
17 cm – 6<sup>3</sup>/<sub>4</sub>"  
**Bailey**



**54.25.50**  
17 cm – 6<sup>3</sup>/<sub>4</sub>"  
**Bailey-Gibbon**

**Rippen- und Sternumspreizer  
Rib and Sternal Retractors  
Separadores para costillas y esternón  
Ecarteurs pour costaux et sternum  
Divaricatori costali e sternali**



IMA- Spreizer  
Retractor  
Separador  
Ecarteur  
Divaricatore

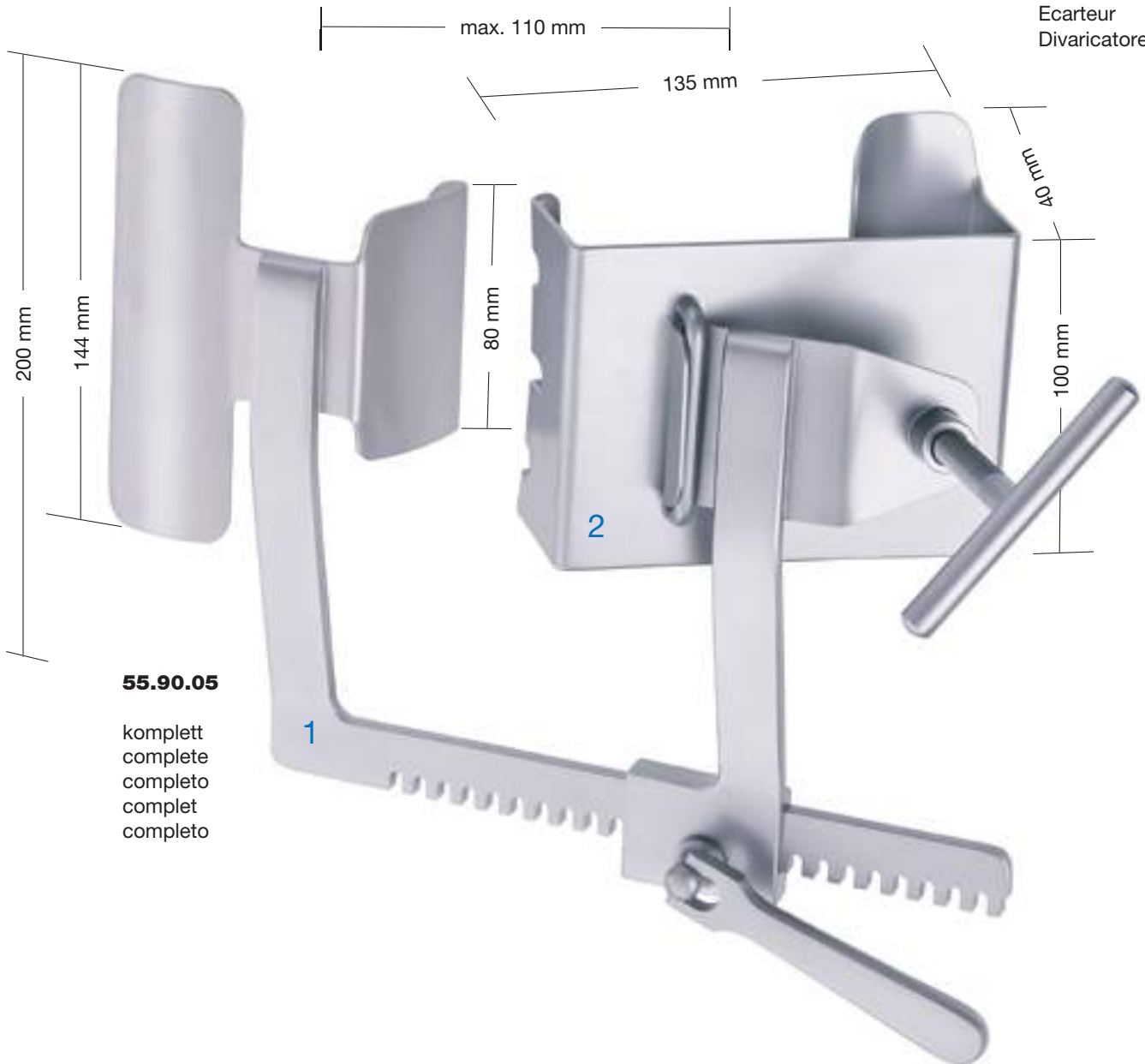

**55.90.05**

komplett  
complete  
completo  
complet  
completo

**1 55.90.06**

Spreizer allein (ohne Mammaria-Valve)  
Retractor only (without mammary blade)  
Separador solo (sin valva mammaria)  
Ecarteur seul (sans valve mammaire)  
Divaricatore solo (senza valva mammaria)

**2 55.90.07**

Mammaria-Valve allein  
Mammary blade only  
Valva mammaria sola  
Valve mammaire seule  
Valva mammaria solo



**Rippen- und Sternumspreizer**  
**Rib and Sternal Retractors**  
**Separadores para costillas y esternón**  
**Ecarteurs pour costaux et sternum**  
**Divaricatori costali e sternali**

16

IMA- Spreizer  
 Retractor  
 Separador  
 Ecarteur  
 Divaricatore

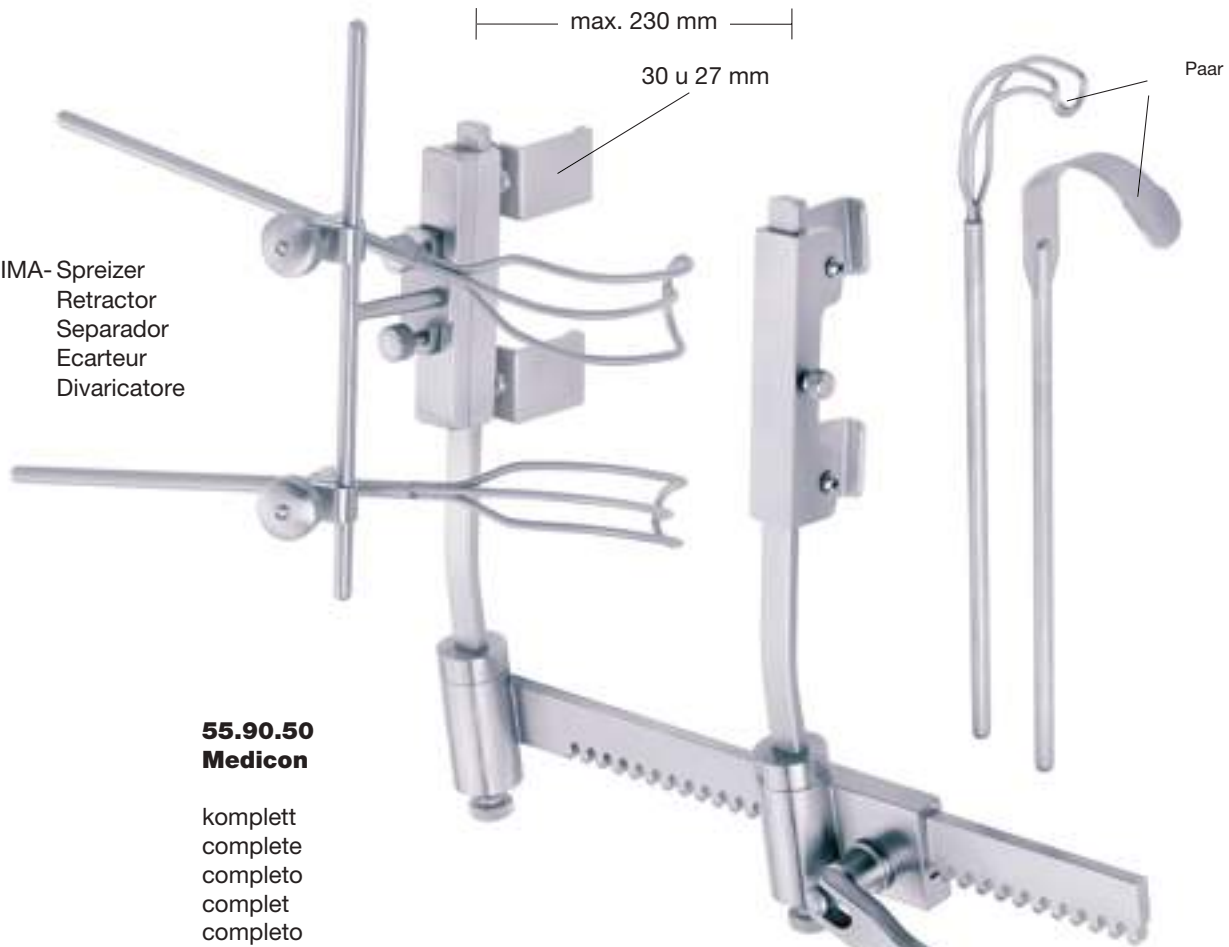

**55.90.50**  
**Medicon**

komplett  
 complete  
 completo  
 complet  
 completo

biegsam  
 malleable  
 maleable  
 malléable  
 malleabile



Valvenarme drehbar  
 Blade brackets rotating  
 Soporte de valvas rotatorias  
 Supports de valves pivotants  
 Supporto di valve girevole  
 (30° / 60°)

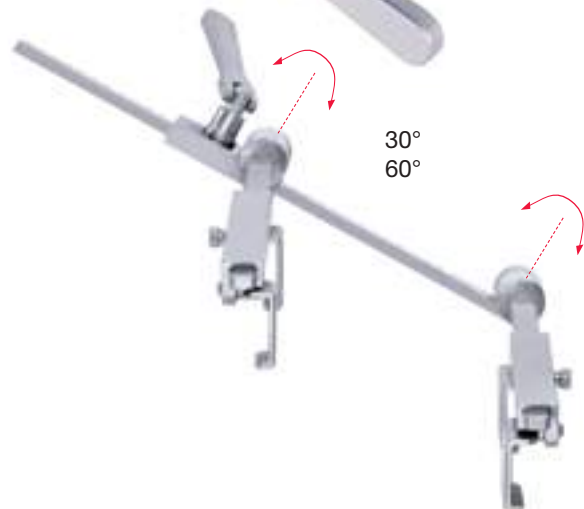

**Rippen- und Sternumspreizer**  
**Rib and Sternal Retractors**  
**Separadores para costillas y esternón**  
**Ecarteurs pour costaux et sternum**  
**Divaricatori costali e sternali**



IMA-Spreizer  
 Retractor  
 Separador  
 Ecarteur  
 Divaricatore

16

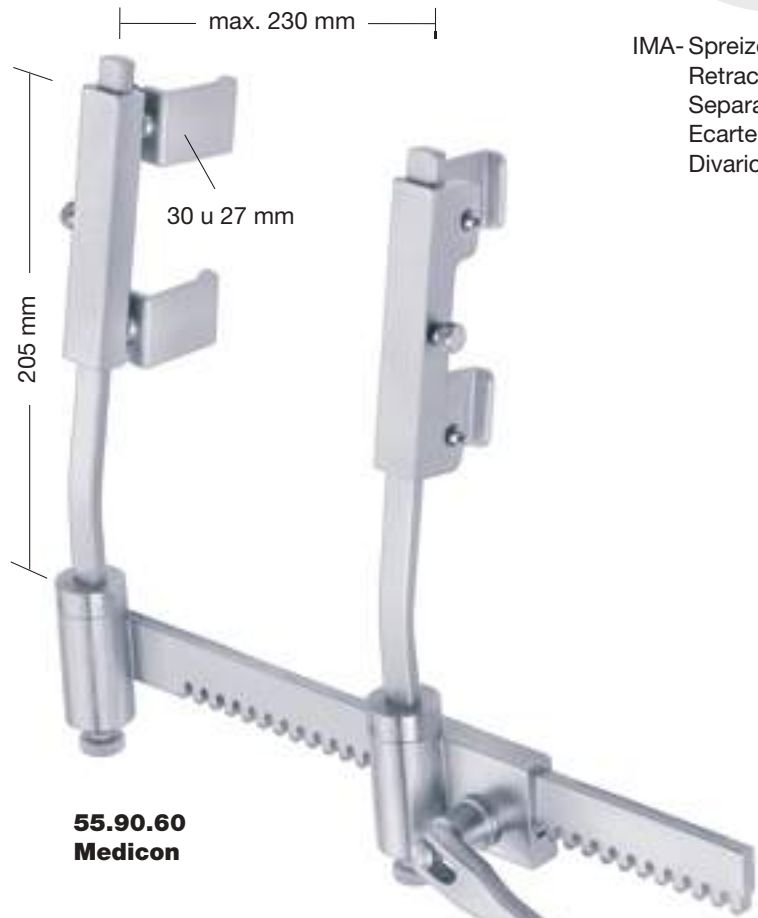

**55.90.60**  
**Medicon**



**55.90.55**  
**Medicon**



biegsam  
 malleable  
 maleable  
 malléable  
 malleabile

Valvenset für 55.90.60  
 Blade set for 55.90.60  
 Juego de valvas para 55.90.60  
 Jeu de valves pour 55.90.60  
 Set di valve per 55.90.60



**Rippen- und Sternumspreizer**  
**Rib and Sternal Retractors**  
**Separadores para costillas y esternón**  
**Ecarteurs pour costaux et sternum**  
**Divaricatori costali e sternali**

16

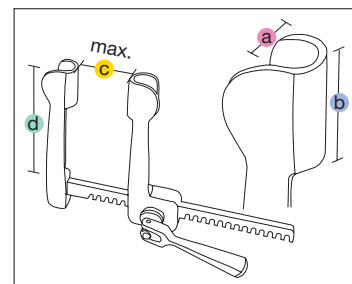

**Morse Sternal**

		a	b	c	d	e	
		mm	mm	mm	mm	mm	
<b>54.18.55</b> <b>54.18.57</b>	stainless steel Alu	20	28	200	150	72	für Erwachsene for adults para adultos pour adultes per adulti
<b>54.18.50</b> <b>54.18.52</b>	stainless steel Alu	20	20	160	120	50	für Kinder for children para niños pour enfants per bambini

**Rippen- und Sternumspreizer**  
**Rib and Sternal Retractors**  
**Separadores para costillas y esternón**  
**Ecarteurs pour costaux et sternum**  
**Divaricatori costali e sternali**



**Morse Favalaro Sternal**

a b c d e

		mm	mm	mm	mm	mm	
<b>54.18.60</b> <b>54.18.62</b>	stainless steel Alu	40	20	155	175	65	für Erwachsene for adults para adultos pour adultes per adulti
<b>54.18.65</b> <b>54.18.67</b>	stainless steel Alu	12	20	155	120	50	für Kinder for children para niños pour enfants per bambini



**Rippen- und Sternumspreizer**  
**Rib and Sternal Retractors**  
**Separadores para costillas y esternón**  
**Ecarteurs pour costaux et sternum**  
**Divaricatori costali e sternali**

16

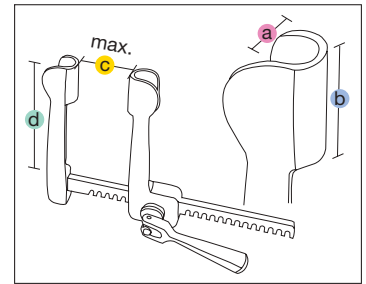
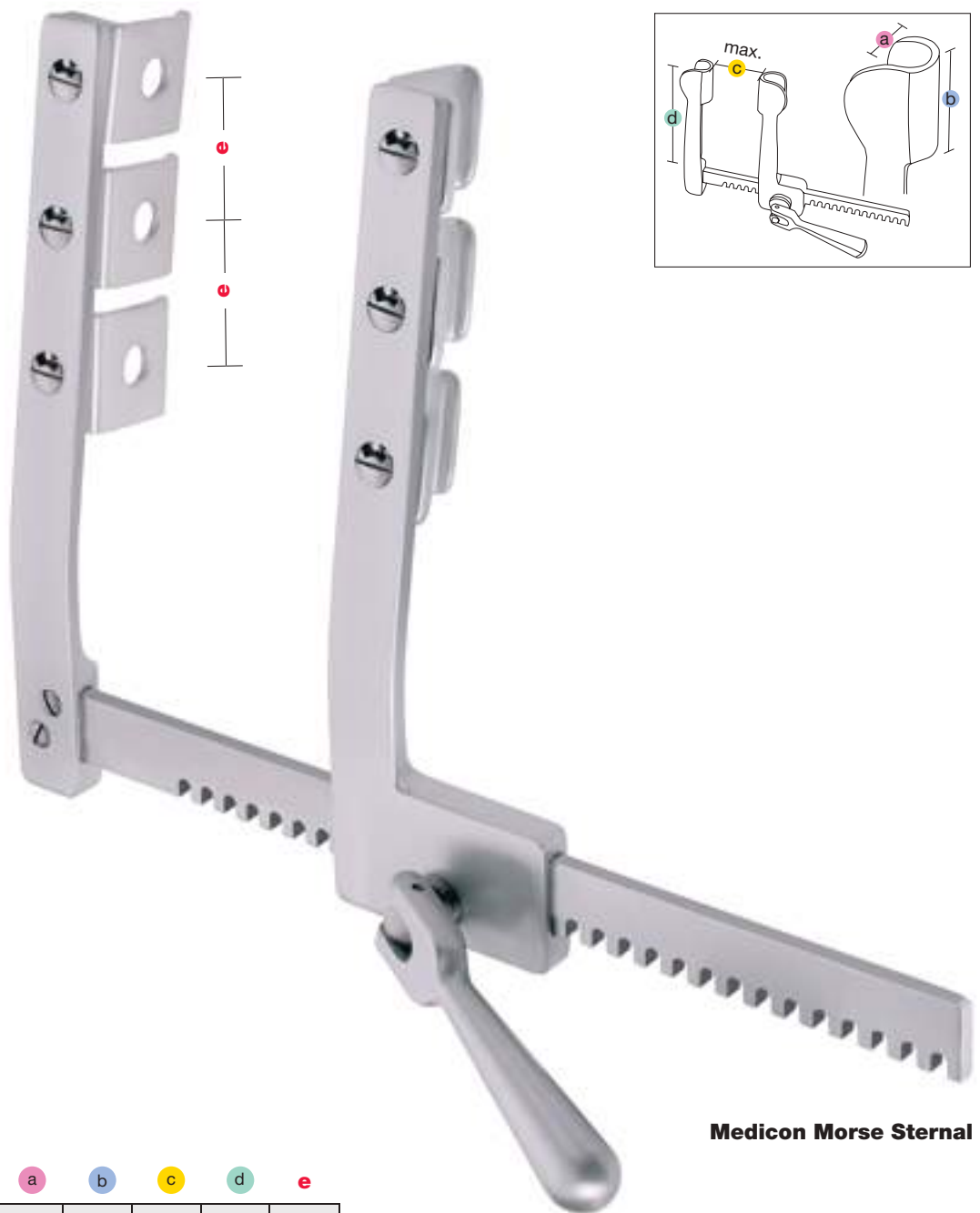

**Medicon Morse Sternal**

		a	b	c	d	e	
		mm	mm	mm	mm	mm	
<b>54.18.70</b>	stainless steel	30	35	200	195	42	für Erwachsene for adults
<b>54.18.72</b>	Alu						para adultos pour adultes per adulti

**Rippen- und Sternumspreizer**  
**Rib and Sternal Retractors**  
**Separadores para costillas y esternón**  
**Ecarteurs pour costaux et sternum**  
**Divaricatori costali e sternali**

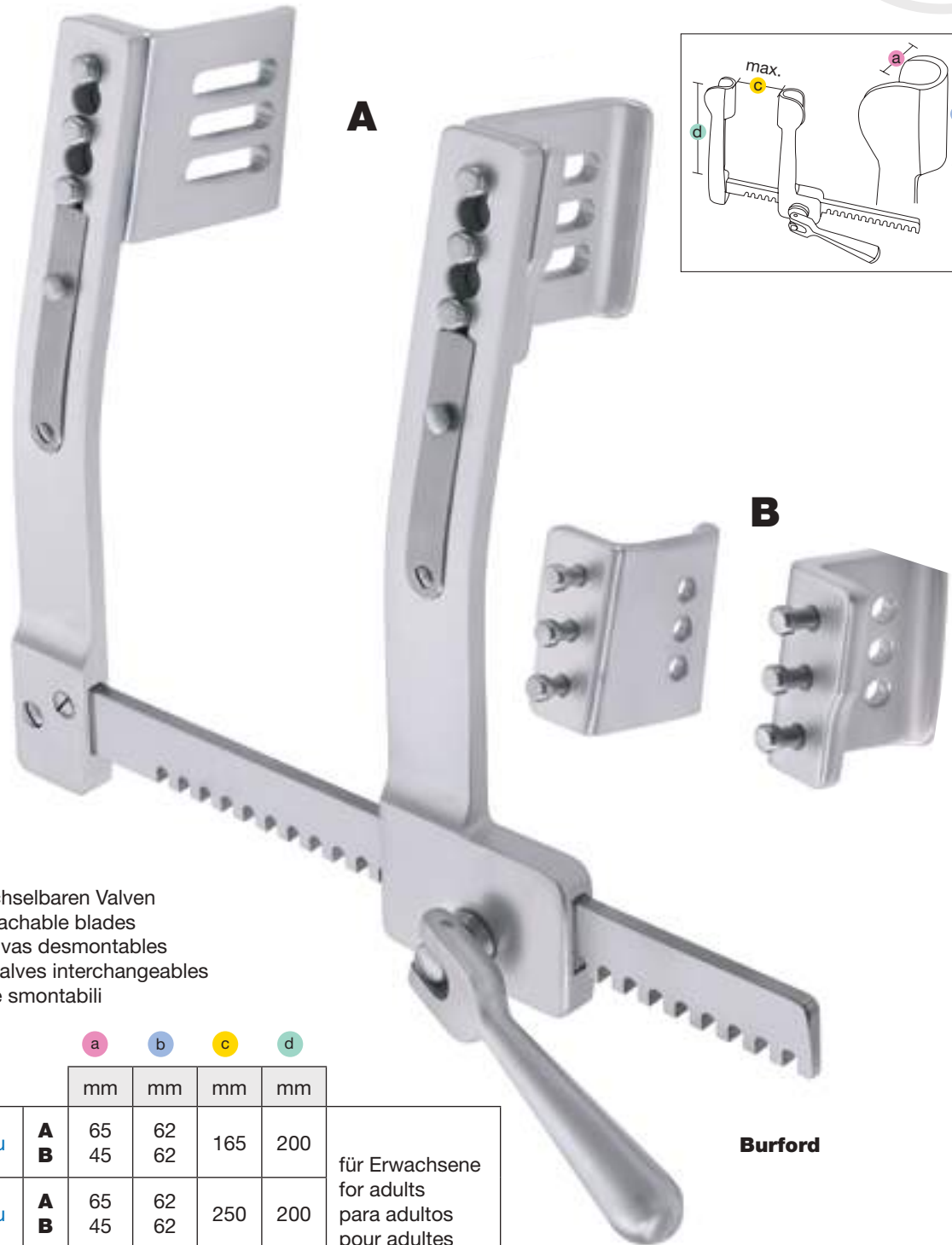

16

mit **2 Paar** auswechselbaren Valven  
 with **2 pairs** of detachable blades  
 con **2 pares** de valvas desmontables  
 avec **2 paires** de valves interchangeables  
 con **2 paia** di valve smontabili

**a**   **b**   **c**   **d**

mm   mm   mm   mm

<b>54.23.53</b>	Alu	<b>A</b>	65	62	165	200	für Erwachsene for adults para adultos pour adultes per adulti
		<b>B</b>	45	62			
<b>54.23.54</b>	Alu	<b>A</b>	65	62	250	200	
		<b>B</b>	45	62			
<b>54.23.55</b>	Alu	<b>A</b>	65	62	290	200	
		<b>B</b>	45	62			

**Burford**





**Rippen- und Sternumspreizer**  
**Rib and Sternal Retractors**  
**Separadores para costillas y esternón**  
**Ecarteurs pour costaux et sternum**  
**Divaricatori costali e sternali**

16

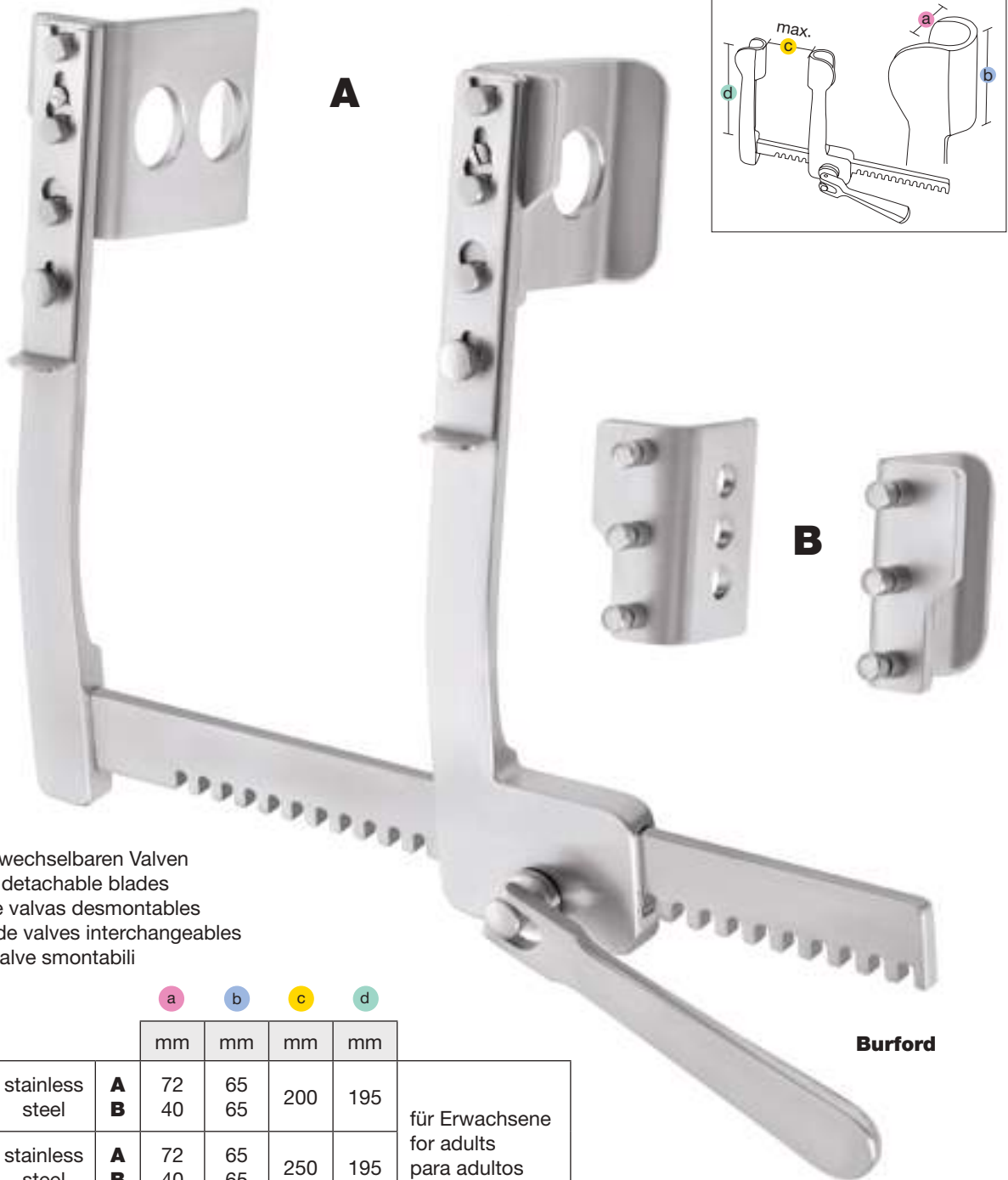

mit **2 Paar** auswechselbaren Valven  
 with **2 pairs** of detachable blades  
 con **2 pares** de valvas desmontables  
 avec **2 paires** de valves interchangeables  
 con **2 paia** di valve smontabili

**a**   **b**   **c**   **d**

mm   mm   mm   mm

<b>54.23.42</b>	stainless steel	<b>A</b>	72	65	200	195	für Erwachsene for adults para adultos pour adultes per adulti
		<b>B</b>	40	65			
<b>54.23.43</b>	stainless steel	<b>A</b>	72	65	250	195	
		<b>B</b>	40	65			
<b>54.23.44</b>	stainless steel	<b>A</b>	72	65	300	195	
		<b>B</b>	40	65			

**Burford**

**Rippen- und Sternumspreizer**  
**Rib and Sternal Retractors**  
**Separadores para costillas y esternón**  
**Ecarteurs pour costaux et sternum**  
**Divaricatori costali e sternali**

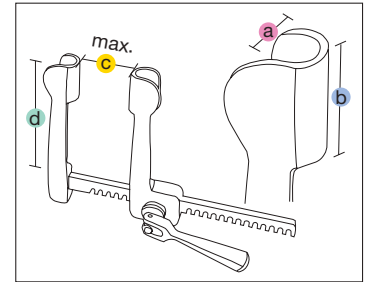

16

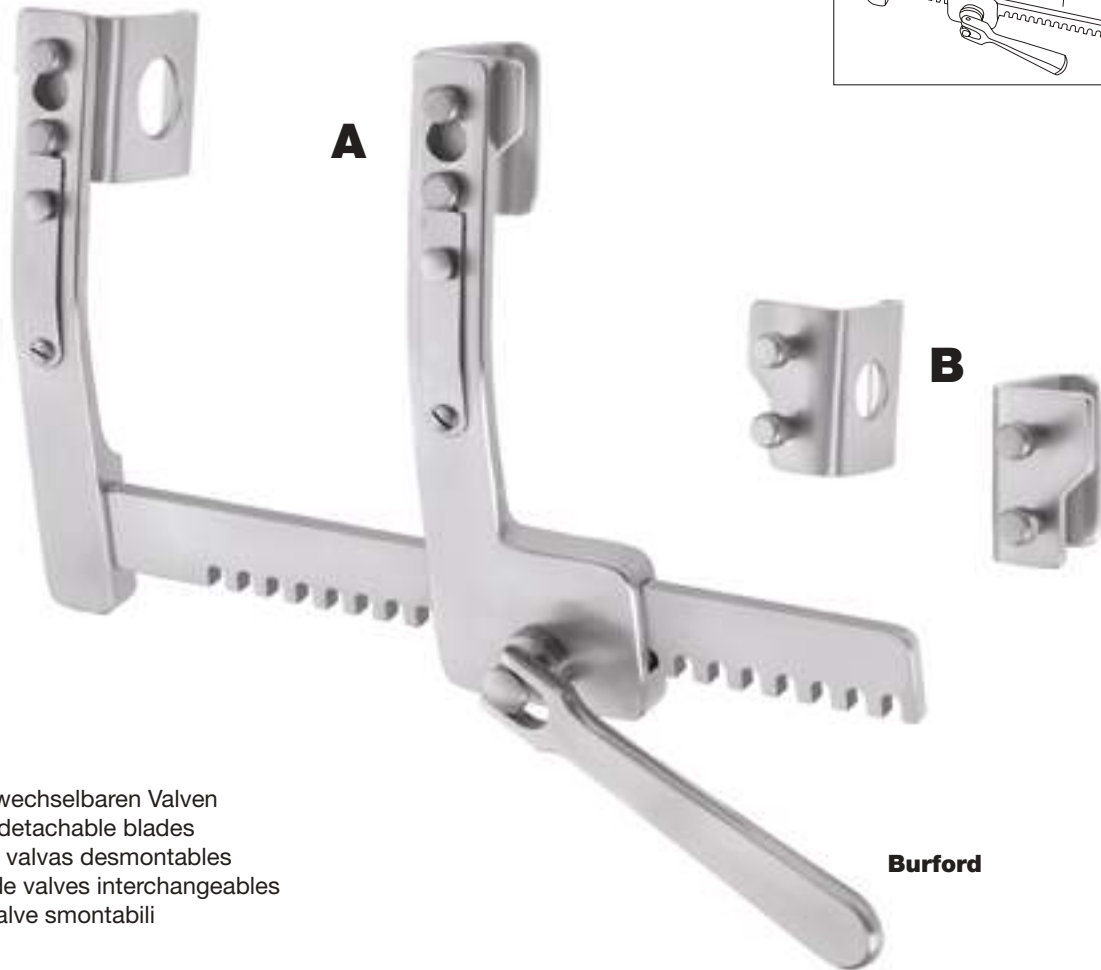

mit **2 Paar** auswechselbaren Valven  
 with **2 pairs** of detachable blades  
 con **2 pares** de valvas desmontables  
 avec **2 paires** de valves interchangeables  
 con **2 paia** di valve smontabili

**Burford**

			a	b	c	d	
			mm	mm	mm	mm	
<b>54.23.48</b>	stainless steel	<b>A</b>	41	42	130	117	für Kinder for children para niños pour enfants per bambini
		<b>B</b>	30	42			
<b>54.23.50</b>	Alu	<b>A</b>	41	42	130	117	
		<b>B</b>	30	42			



**Rippen- und Sternumspreizer**  
**Rib and Sternal Retractors**  
**Separadores para costillas y esternón**  
**Ecarteurs pour costaux et sternum**  
**Divaricatori costali e sternali**

16

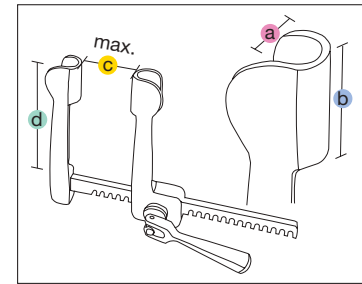

**DeBakey**

a b c d

		mm	mm	mm	mm	
<b>54.23.72</b>	stainless steel	40	100	200	185	für Erwachsene for adults para adultos pour adultes per adulti
		50	80			
		60	80			
<b>54.23.70</b>	stainless steel	30	30	175	145	für Kinder for children para niños pour enfants per bambini
		40	40			
		50	50			

mit **3 Paar** auswechselbaren Valven  
 with **3 pairs** of detachable blades  
 con **3 pares** de valvas desmontables  
 avec **3 paires** de valves interchangeables  
 con **3 paia** di valve smontabili

**Rippen- und Sternumspreizer**  
**Rib and Sternal Retractors**  
**Separadores para costillas y esternón**  
**Ecarteurs pour costaux et sternum**  
**Divaricatori costali e sternali**

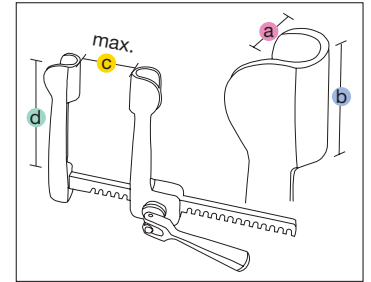

16



**Struck**

a	b	c	d
mm	mm	mm	mm

<b>54.23.74</b>	stainless steel	15 20	20 20	70	55	für Kleinkinder for infants para niños pour petits enfants per bambini
-----------------	-----------------	----------	----------	----	----	--

mit **2 Paar** auswechselbaren Valven  
with **2 pairs** of detachable blades  
con **2 pares** de valvas desmontables  
avec **2 paires** de valves interchangeables  
con **2 paia** di valve smontabili



**Rippen- und Sternumspreizer**  
**Rib and Sternal Retractors**  
**Separadores para costillas y esternón**  
**Ecarteurs pour costaux et sternum**  
**Divaricatori costali e sternali**

16

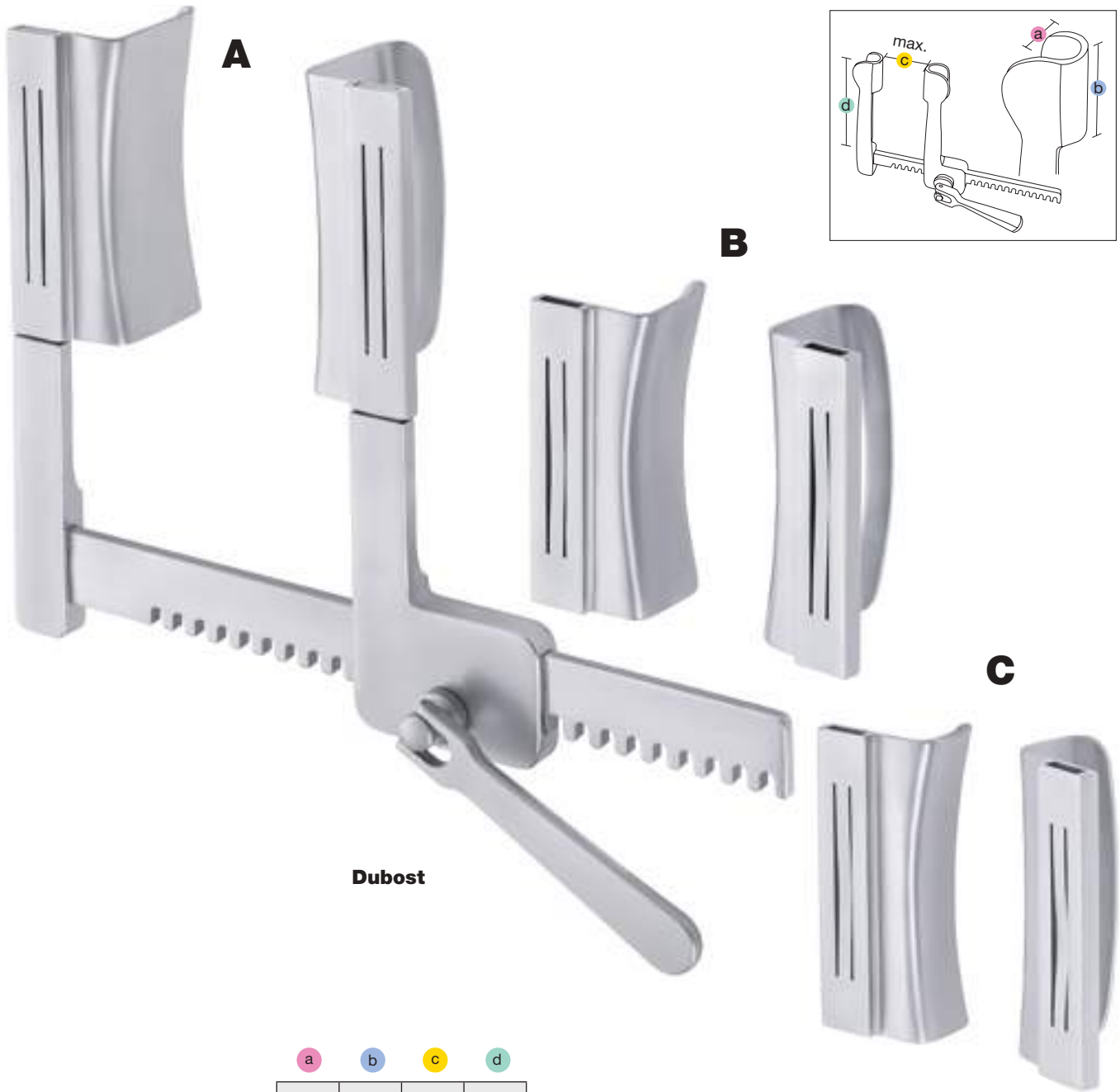

**Dubost**

**a**   **b**   **c**   **d**

mm   mm   mm   mm

<b>54.23.76</b>	stainless steel	<b>A</b>	50	100		160	für Erwachsene for adults para adultos pour adultes per adulti
		<b>B</b>	40	100			
		<b>C</b>	30	100			

mit **3 Paar** auswechselbaren Valven  
with **3 pairs** of detachable blades  
con **3 pares** de valvas desmontables  
avec **2 paires** de valves interchangeables  
con **3 paia** di valve smontabili

**Rippen- und Sternumspreizer**  
**Rib and Sternal Retractors**  
**Separadores para costillas y esternón**  
**Ecarteurs pour costaux et sternum**  
**Divaricatori costali e sternali**

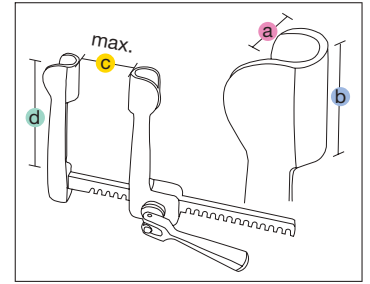

16



mit Fadenfänger  
 with suture catcher  
 con captador de hilos  
 avec porte-fils  
 con porta legature

**Medicon-Ankeney**

a b c d e

mm mm mm mm mm

<b>54.23.78</b>	Alu	20	20	160	115	30	für Kinder for children para niños pour enfants per bambini
-----------------	-----	----	----	-----	-----	----	---



**Rippen- und Sternumspreizer**  
**Rib and Sternal Retractors**  
**Separadores para costillas y esternón**  
**Ecarteurs pour costaux et sternum**  
**Divaricatori costali e sternali**

16

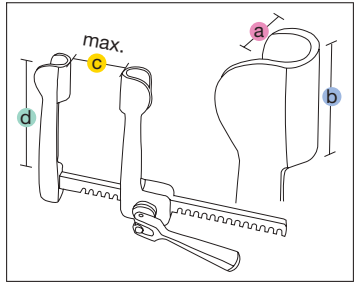
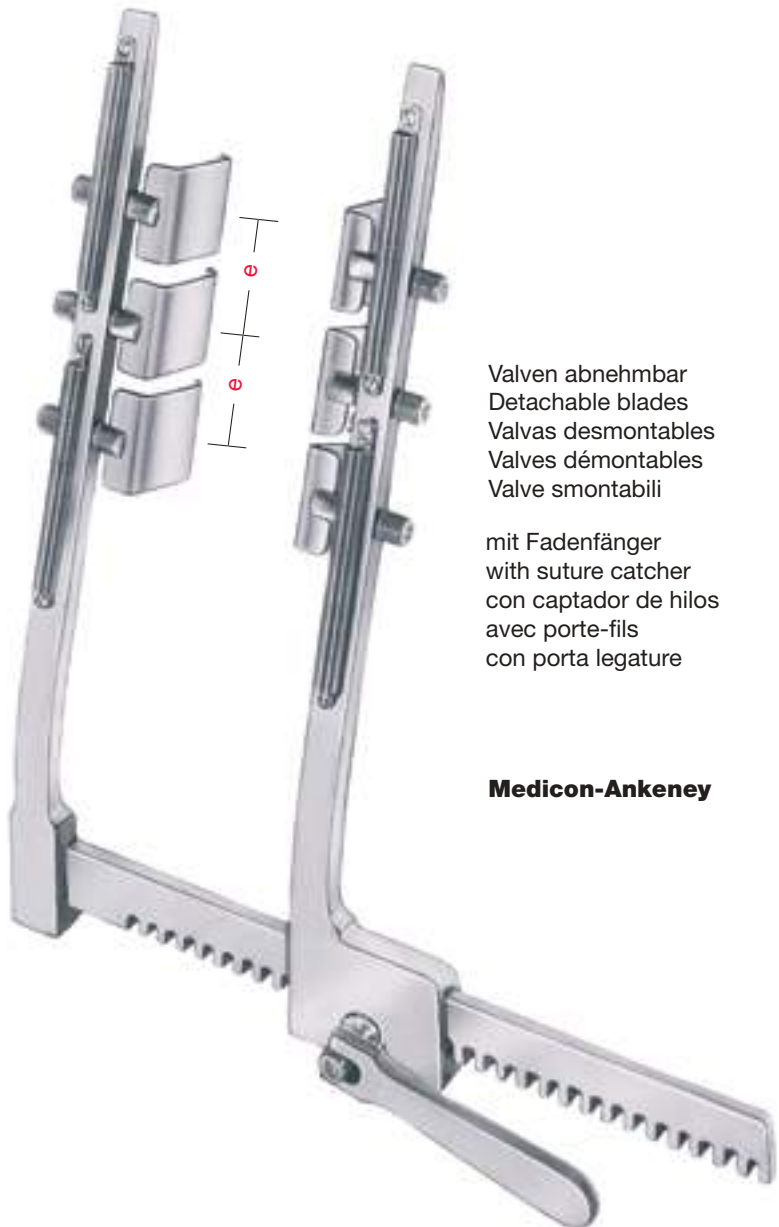

Valven abnehmbar  
 Detachable blades  
 Valvas desmontables  
 Valves démontables  
 Valve smontabili

mit Fadenfänger  
 with suture catcher  
 con captador de hilos  
 avec porte-fils  
 con porta legature

**Medicon-Ankeney**

a b c d e

		mm	mm	mm	mm	mm	
<b>54.23.80</b>	stainless steel	33	35	180	300	45	für Erwachsene for adults para adultos pour adultes per adulti

**Rippen- und Sternumspreizer**  
**Rib and Sternal Retractors**  
**Separadores para costillas y esternón**  
**Ecarteurs pour costaux et sternum**  
**Divaricatori costali e sternali**

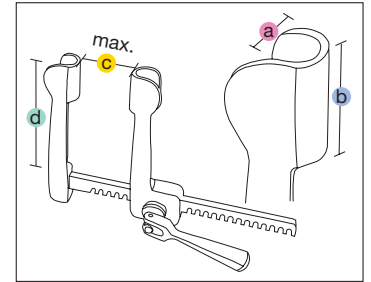

16



**Finochietto-Baby-Haight**  
**Finochietto-Infant**

		a	b	c	d		
		mm	mm	mm	mm		
<b>54.22.67</b> <b>54.22.65</b>	stainless steel	28	30	100	75	für Kinder for children para niños pour enfants per bambini	Finochietto-Baby-Haight
	Alu						

		a	b	c	d		
		mm	mm	mm	mm		
<b>54.22.63</b> <b>54.22.61</b>	stainless steel	12	15	70	55	für Kleinkinder for infants para niños pour petits enfants per bambini	Finochietto-Infant
	Alu						





**Rippen- und Sternumspreizer**  
**Rib and Sternal Retractors**  
**Separadores para costillas y esternón**  
**Ecarteurs pour costaux et sternum**  
**Divaricatori costali e sternali**

16

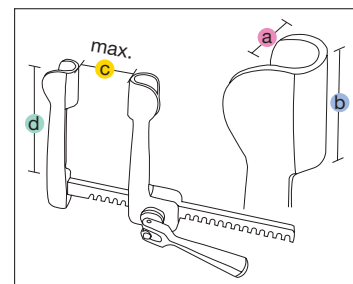

**Finochietto**

		a	b	c	d	
		mm	mm	mm	mm	
<b>54.22.60</b>	stainless steel	6	7	36	25	für Neugeborene for newborns para recién nacidos pour nouveau-nés per neonati



**Medicon-Finochietto**

		a	b	c	d	e	
		mm	mm	mm	mm	mm	
<b>54.22.64</b>	Alu	10	15	120	105	40	für Kleinkinder for infants para niños pour petits enfants per bambini

**Rippen- und Sternumspreizer**  
**Rib and Sternal Retractors**  
**Separadores para costillas y esternón**  
**Ecarteurs pour costaux et sternum**  
**Divaricatori costali e sternali**

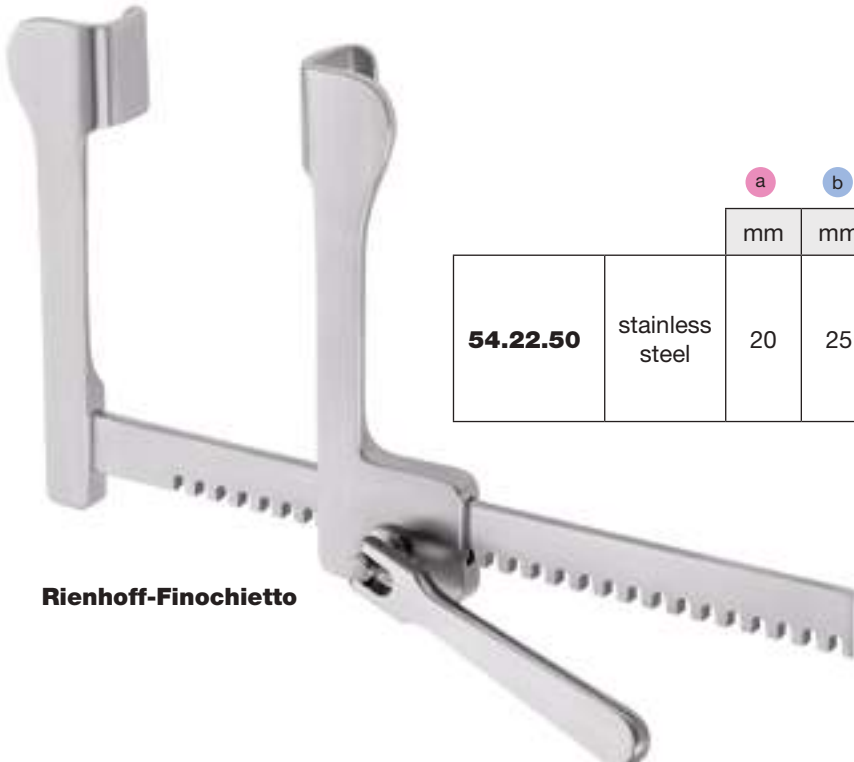
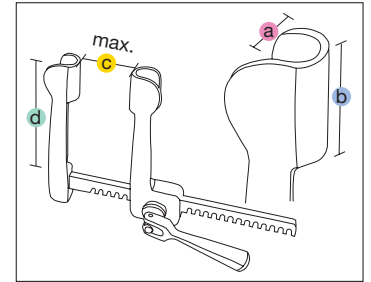

**Rienhoff-Finochietto**

		a	b	c	d	
		mm	mm	mm	mm	
<b>54.22.50</b>	stainless steel	20	25	150	110	für Erwachsene und Kinder for adults and children para adultos y niños pour adultes et enfants per adulti e bambini



**Baby-Haight**

		a	b	c	d	
		mm	mm	mm	mm	
<b>54.22.21</b>	stainless steel	30	30	120	90	für Erwachsene for adults para adultos pour adultes per adulti
<b>54.22.20</b>	stainless steel	30	30	85	70	für Kinder for children para niños pour enfants per bambini



**Rippen- und Sternumspreizer**  
**Rib and Sternal Retractors**  
**Separadores para costillas y esternón**  
**Ecarteurs pour costaux et sternum**  
**Divaricatori costali e sternali**

16

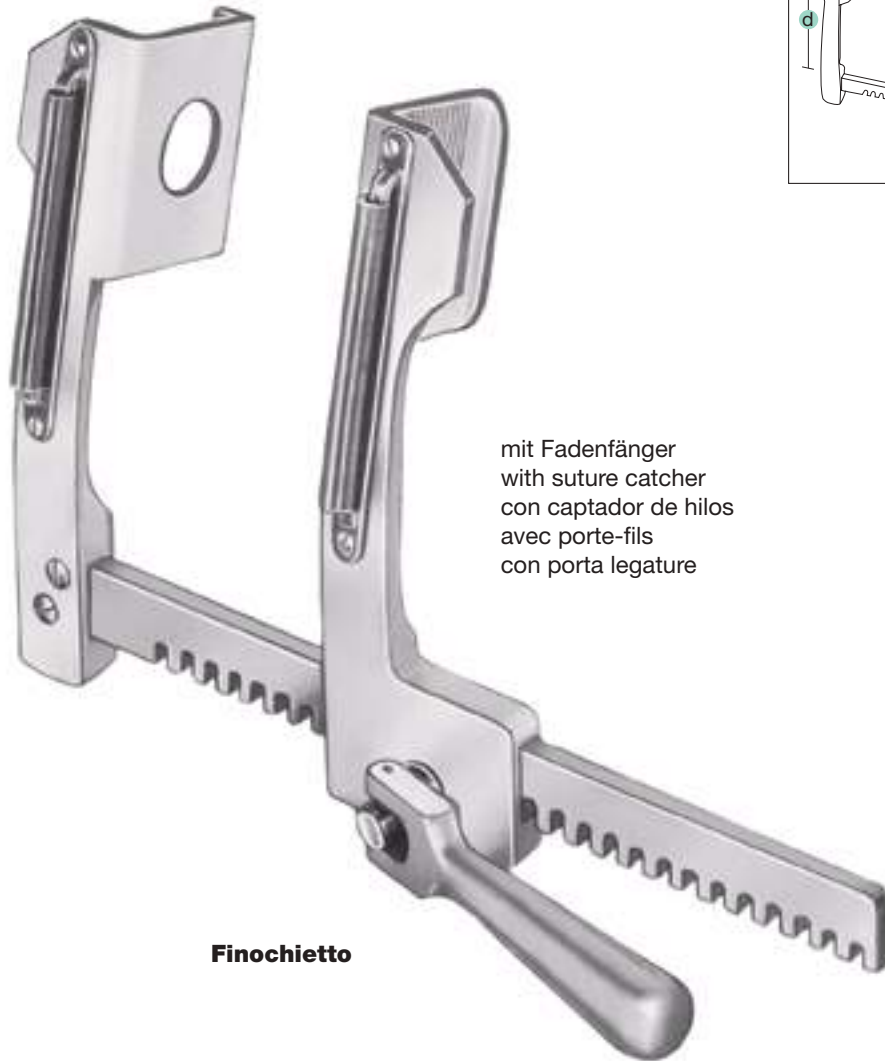
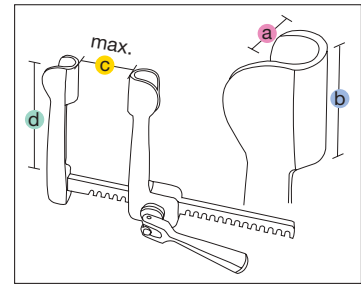

mit Fadenfänger  
 with suture catcher  
 con captador de hilos  
 avec porte-fils  
 con porta legature

**Finochietto**

		a	b	c	d	
		mm	mm	mm	mm	
<b>54.23.05</b>	Alu	42	62	170	140	für Erwachsene for adults para adultos pour adultes per adulti

**Rippen- und Sternumspreizer**  
**Rib and Sternal Retractors**  
**Separadores para costillas y esternón**  
**Ecarteurs pour costaux et sternum**  
**Divaricatori costali e sternali**

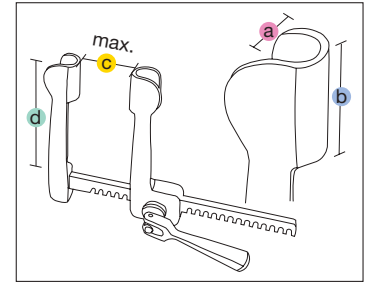

16

**Castaneda Sternal**

**a**   **b**   **c**   **d**

mm   mm   mm   mm

		a	b	c	d	
		mm	mm	mm	mm	
<b>54.23.57</b>	Alu	10	30	65	50	für Neugeborene for newborns para recién nacidos pour nouveau-nés per neonati
<b>54.23.58</b>	Alu	12	45	72	70	für Kleinkinder for infants para niños pour petits enfants per bambini
<b>54.23.59</b>	Alu	15	60	100	130	für Kinder for children para niños pour enfants per bambini



**Rippen- und Sternumspreizer**  
**Rib and Sternal Retractors**  
**Separadores para costillas y esternón**  
**Ecarteurs pour costaux et sternum**  
**Divaricatori costali e sternali**

16



30 T 50 mm

Scapulla-Valven, abnehmbar  
 Scapula blades, detachable  
 Valvas escápula, desmontable  
 Valves pour omoplate, démontables  
 Valve per scapola, smontabili

**Harken-Nissen**

a b c d

mm mm mm mm

<b>54.23.21</b>	stainless steel	40	75	185	185	für Erwachsene for adults para adultos pour adultes per adulti
-----------------	-----------------	----	----	-----	-----	--

**Rippen- und Sternumspreizer**  
**Rib and Sternal Retractors**  
**Separadores para costillas y esternón**  
**Ecarteurs pour costaux et sternum**  
**Divaricatori costali e sternali**

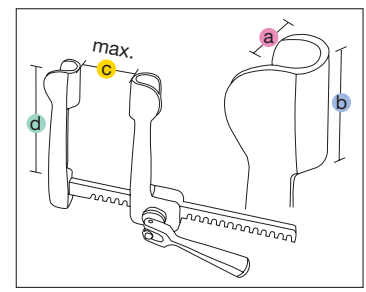

16

**Finochietto**

**a**   **b**   **c**   **d**

mm   mm   mm   mm

		a	b	c	d	
		mm	mm	mm	mm	
<b>54.23.01</b> <b>54.23.11</b>	stainless steel Alu	30	45	140	110	für Erwachsene und Kinder for adults and children para adultos y niños pour adultes et enfants per adulti e bambini
<b>54.23.02</b> <b>54.23.12</b>	stainless steel Alu	42	62	185	140	für Erwachsene, mittel for adults, medium para adultos, mediano pour adultes, moyen per adulti, medio
<b>54.23.03</b> <b>54.23.13</b>	stainless steel Alu	73	65	185	140	für Erwachsene, groß for adults, large para adultos, grande pour adultes, grand per adulti, grande



**Rippen- und Sternumspreizer**  
**Rib and Sternal Retractors**  
**Separadores para costillas y esternón**  
**Ecarteurs pour costaux et sternum**  
**Divaricatori costali e sternali**

16

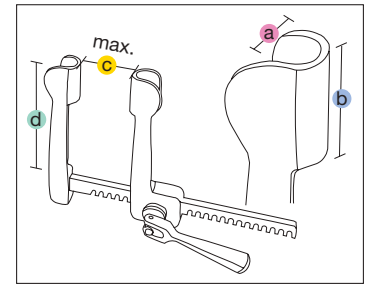

**Cooley**

		<span style="color: red;">a</span>	<span style="color: blue;">b</span>	<span style="color: yellow;">c</span>	<span style="color: green;">d</span>	
		mm	mm	mm	mm	
<b>54.23.86</b> <b>54.23.62</b>	stainless steel Alu	30	50	185	145	für Erwachsene for adults para adultos pour adultes per adulti
<b>54.23.82</b> <b>54.23.64</b>	stainless steel Alu	20	45	140	110	für Kinder for children para niños pour enfants per bambini

**Rippen- und Sternumspreizer**  
**Rib and Sternal Retractors**  
**Separadores para costillas y esternón**  
**Ecarteurs pour costaux et sternum**  
**Divaricatori costali e sternali**

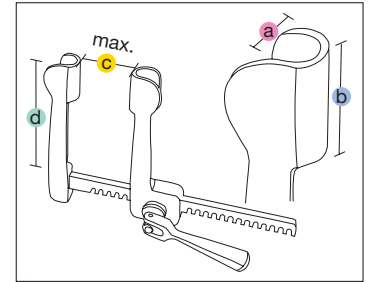
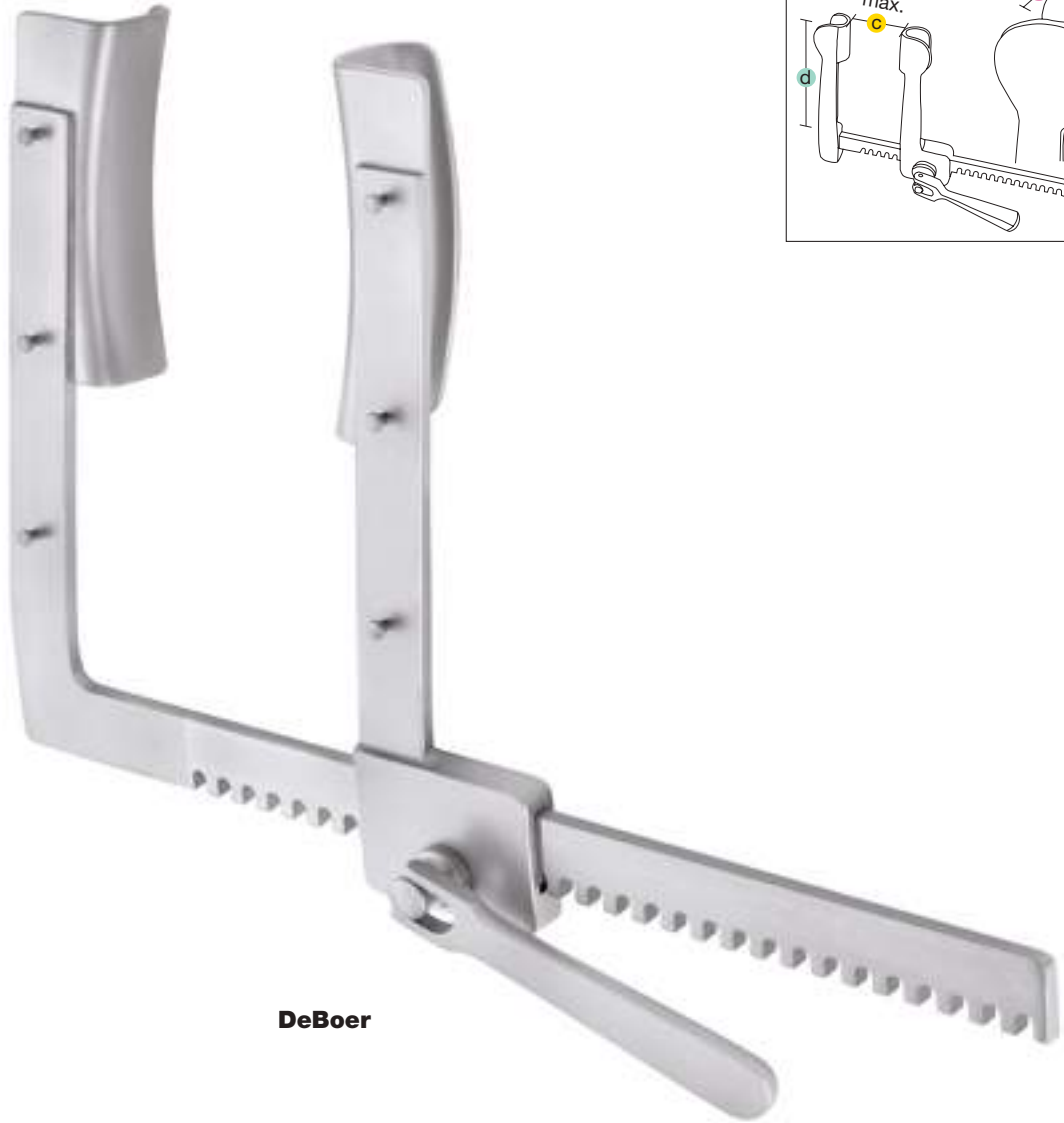

16

**DeBoer**

**a**   **b**   **c**   **d**

mm   mm   mm   mm

<b>54.23.90</b>	stainless steel	<b>a</b>	<b>b</b>	<b>c</b>	<b>d</b>	für Erwachsene for adults para adultos pour adultes per adulti
		30	100	210	185	





**Rippen- und Sternumspreizer**  
**Rib and Sternal Retractors**  
**Separadores para costillas y esternón**  
**Ecarteurs pour costaux et sternum**  
**Divaricatori costali e sternali**

16



**Tuffier**

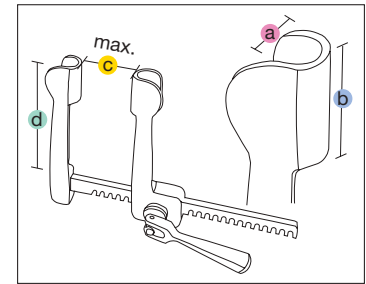

		a	b	c	d	
		mm	mm	mm	mm	
<b>54.22.41</b>	stainless steel	42	45	170	110	für Erwachsene for adults para adultos pour adultes per adulti



**Tuffier**

		a	b	c	d	
		mm	mm	mm	mm	
<b>54.22.42</b>	stainless steel	42	45	170	110	für Erwachsene for adults para adultos pour adultes per adulti

**Rippen- und Sternumspreizer**  
**Rib and Sternal Retractors**  
**Separadores para costillas y esternón**  
**Ecarteurs pour costaux et sternum**  
**Divaricatori costali e sternali**



16



**Cooley**

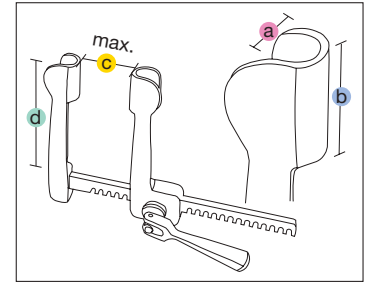

		a	b	c	d	
		mm	mm	mm	mm	
<b>54.23.67</b>	Alu	15	20	100	80	für Kleinkinder for infants para niños pour petits enfants per bambini



**Cooley**

		a	b	c	d	
		mm	mm	mm	mm	
<b>54.23.69</b>	Alu	20	25	100	80	für Kleinkinder for infants para niños pour petits enfants per bambini



**Rippen- und Sternumspreizer**  
**Rib and Sternal Retractors**  
**Separadores para costillas y esternón**  
**Ecarteurs pour costaux et sternum**  
**Divaricatori costali e sternali**

16



**Cooley**

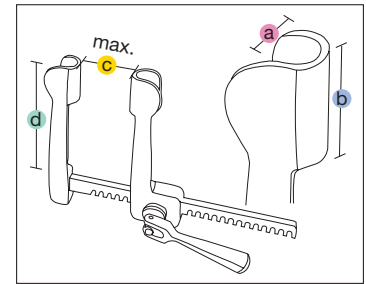

		a	b	c	d	
		mm	mm	mm	mm	
<b>54.23.73</b>	stainless steel	35	110	230	205	für Erwachsene for adults para adultos pour adultes per adulti

**Rippen- und Sternumspreizer**  
**Rib and Sternal Retractors**  
**Separadores para costillas y esternón**  
**Ecarteurs pour costaux et sternum**  
**Divaricatori costali e sternali**

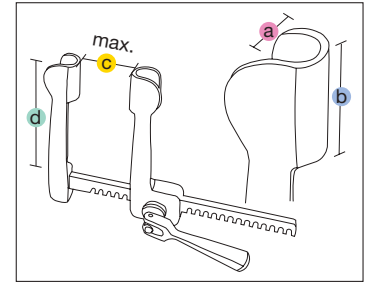

**Cooley**

		a	b	c	d	
		mm	mm	mm	mm	
<b>54.23.65</b>	Alu	12	15	70	60	für Neugeborene for newborns para recién nacidos pour nouveau-nés per neonati

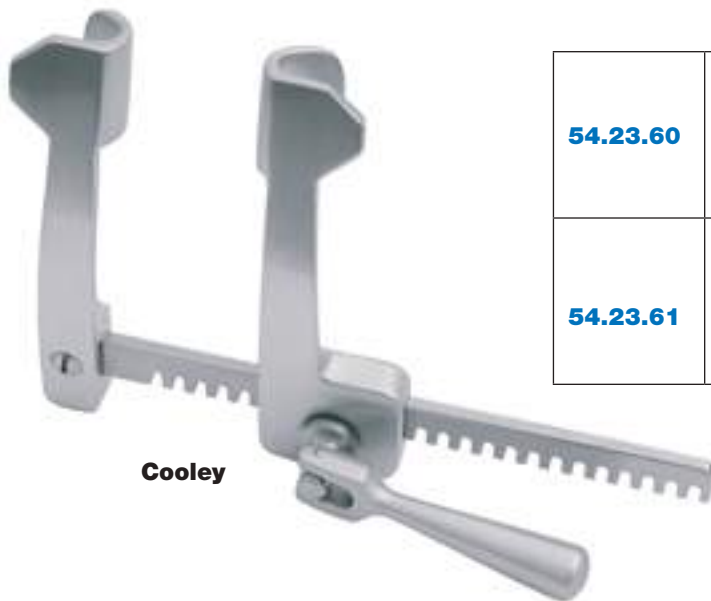

**Cooley**

		a	b	c	d	
		mm	mm	mm	mm	
<b>54.23.60</b>	Alu	14	16	85	60	für Neugeborene for newborns para recién nacidos pour nouveau-nés per neonati
<b>54.23.61</b>	Alu	15	30	115	80	für Kinder for children para niños pour enfants per bambini



**Rippen- und Sternumspreizer**  
**Rib and Sternal Retractors**  
**Separadores para costillas y esternón**  
**Ecarteurs pour costaux et sternum**  
**Divaricatori costali e sternali**

16



**Cooley**

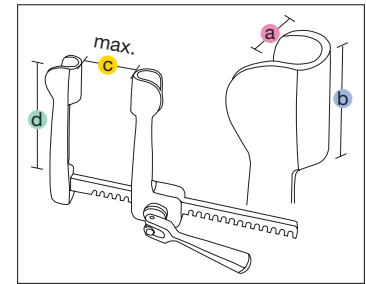

**a**   **b**   **c**   **d**

mm   mm   mm   mm

<b>54.23.63</b>	Alu	35	115	200	200	für Erwachsene for adults para adultos pour adultes per adulti
-----------------	-----	----	-----	-----	-----	--

**Rippen- und Sternumspreizer**  
**Rib and Sternal Retractors**  
**Separadores para costillas y esternón**  
**Ecarteurs pour costaux et sternum**  
**Divaricatori costali e sternali**



**Cooley**

mit Fadenfänger  
 with suture catcher  
 con captador de hilos  
 avec porte-fils  
 con porta legature

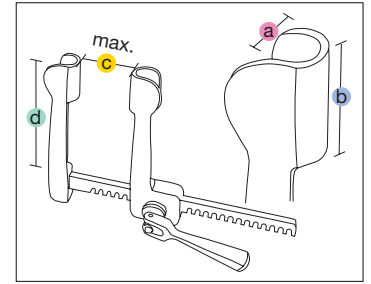

16

a b c d

		mm	mm	mm	mm	
<b>54.23.92</b>	Alu	35	100	180	180	für Erwachsene for adults para adultos pour adultes per adulti



**Rippen- und Sternumspreizer**  
**Rib and Sternal Retractors**  
**Separadores para costillas y esternón**  
**Ecarteurs pour costaux et sternum**  
**Divaricatori costali e sternali**

16

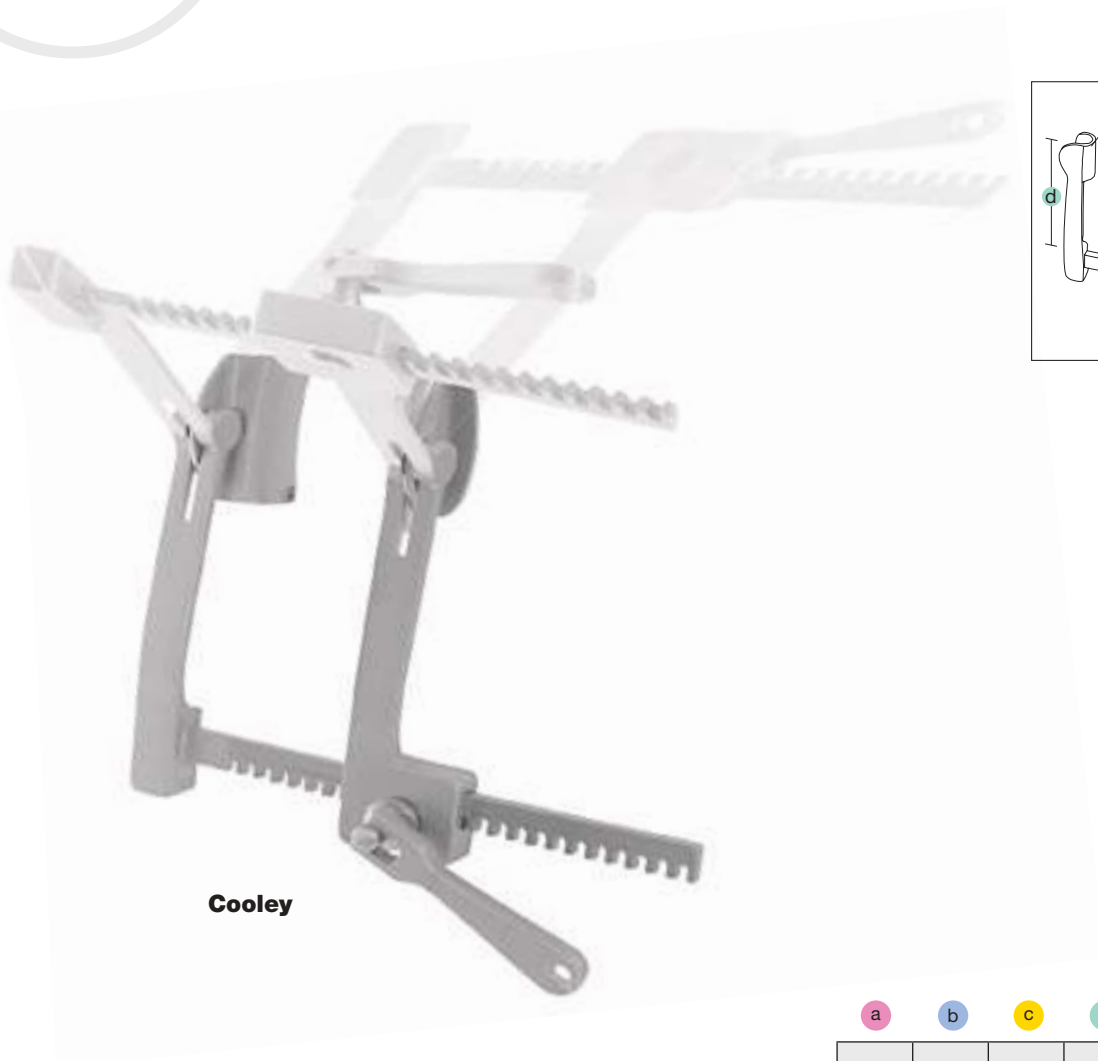

**Cooley**

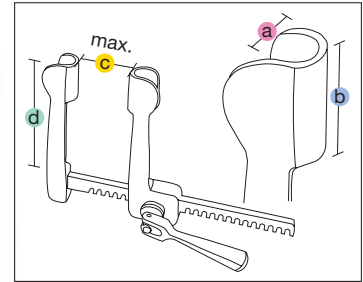

a      b      c      d

mm   mm   mm   mm

		a	b	c	d	
		mm	mm	mm	mm	
<b>54.23.94</b>	stainless steel	10	30	65	60	für Neugeborene for newborns para recién nacidos pour nouveau-nés per neonati
<b>54.23.96</b>	stainless steel	14	45	80	75	für Kleinkinder for infants para niños pour petits enfants per bambini
<b>54.23.98</b>	stainless steel	18	58	90	85	für Kinder for children para niños pour petits enfants per bambini

**Rippen- und Sternumspreizer**  
**Rib and Sternal Retractors**  
**Separadores para costillas y esternón**  
**Ecarteurs pour costaux et sternum**  
**Divaricatori costali e sternali**

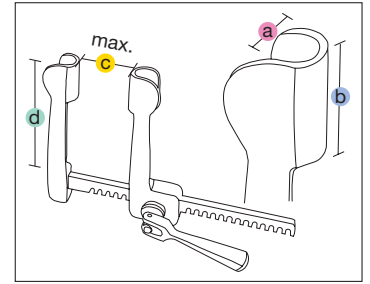

16



**Cooley**

		a	b	c	d	
		mm	mm	mm	mm	
<b>54.23.99</b>	Alu	12	20	95	75	für Kleinkinder for infants para niños pour petits enfants per bambini





**Sternummeißel**  
**Sternum Chisel**  
**Cinzel esternal**  
**Burin à sternum**  
**Scalpello per sterno**

16



**54.18.90**  
25 cm – 10"  
**Lebsche**

**Dilatatoren · Tourniquets**

**Dilators · Tourniquets**

**Dilatadores · Torniquetes**

**Dilatateurs · Tourniquets**

**Dilatatori · Tourniquets**



**Gefäßdilatoren, Tourniquets**  
**Vascular Dilators, Tourniquets**  
**Dilatadores vasculares, Tourniquets**  
**Dilatateurs vasculaires, Tourniquets**  
**Dilatatori vascolari, Tourniquets**

17



**DeBakey**

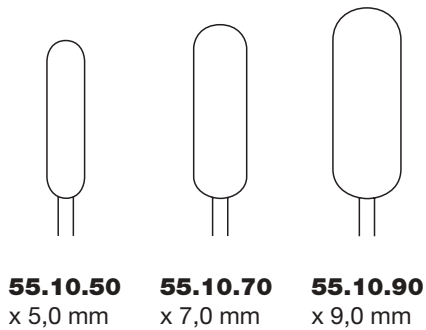
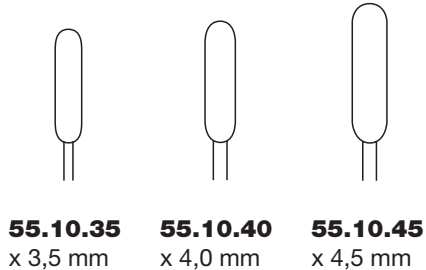
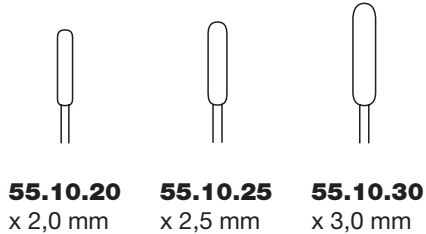
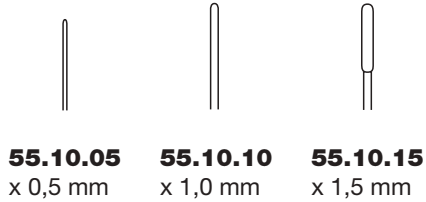

**55.10.00**  
 Satz von 12 DeBakey Gefäßdilatoren  
 Set of 12 DeBakey vascular dilators  
 Juego de 12 DeBakey dilatadores vasculares  
 Jeu de 12 DeBakey dilatateurs vasculaires  
 Serie di 12 DeBakey dilatatori vascolari

**55.09.95**

Mandrin allein  
 Mandrel only  
 Mandril solo  
 Mandrin seul  
 Mandrino solo



**55.09.90**  
**Rumel-Belmont**

**55.09.93**  
**Rumel-Belmont**

**Aorta-Dilatatoren**  
**Aorta Dilators**  
**Dilatadores para aorta**  
**Dilatateurs pour l'aorte**  
**Dilatatori per aorta**



17

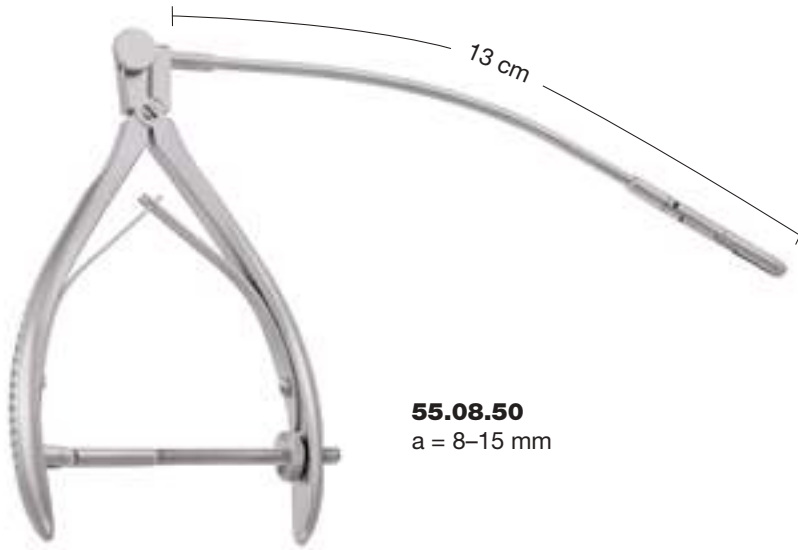

**55.08.50**  
a = 8-15 mm

**Cooley**



**55.08.55**  
a = 9,5-42 mm

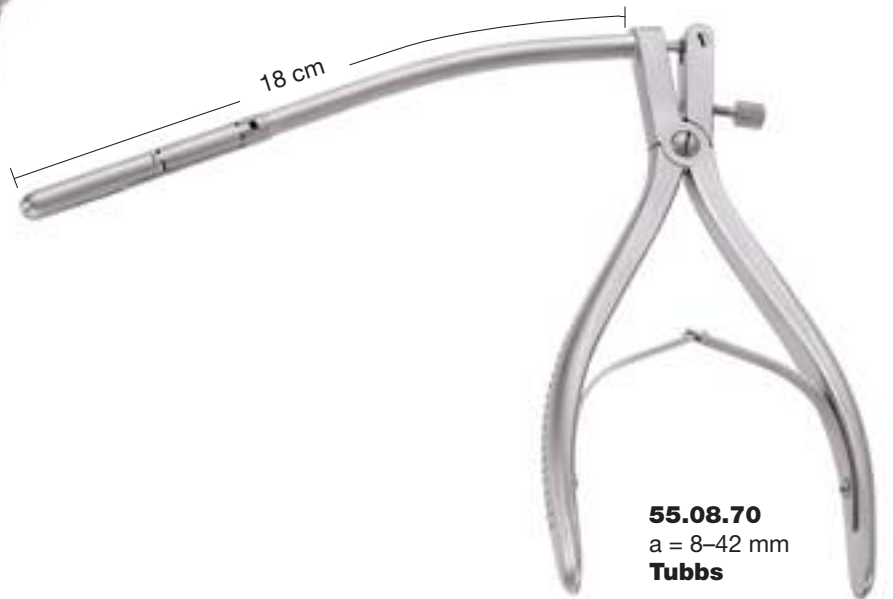
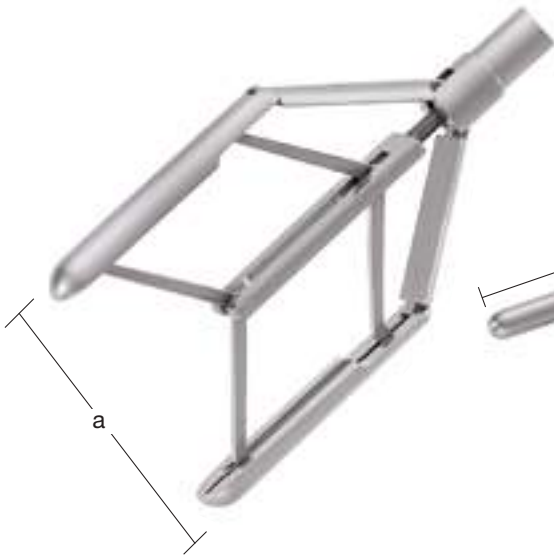

**55.08.70**  
a = 8-42 mm  
**Tubbs**

**Tunnelierbesteck · Aortastanzen  
Valvulotome**

**Tunneling Set · Aorta Punches  
Valvulotomes**

**Juego de instrumentos para tunelización  
Perforadores para aorta · Valvulotomos**

**Jeu pour tunnelisation  
Perforateurs pour l'aorte · Valvulotomes**

**Set per tunnelizzazione · Perforatori per aorta  
Valvulòtomi**



**Tunnelierbesteck**  
**Tunneling Set**  
**Juego de tunelizacion**  
**Jeu pour tunnelisation**  
**Set per tunnelizzazione**

18



**55.08.80**

Satz komplett, bestehend aus:  
6 Paar Oliven, 1 Aufsatz für Venen,  
1 Luer-Adapter, 3 Schäfte, 2 Griffe,  
1 Gabelschlüssel, Metalletui.

Set complete, consisting of 6 pairs  
of olives, 1 vein tip, 1 Luer adaptor,  
3 shafts, 2 handles, 1 wrench, metal  
box.

Juego completo, compuesto por  
6 pares de olivas, 1 cono para venas,  
1 adaptor Luer, 3 vastagos,  
2 mangos, 1 llave horquilla, caja  
metalica.

Jeu complet, composé de 6 paires  
d'olives, 1 embout pour veines,  
1 adaptateur Luer, 3 tiges, 2 manches,  
1 clé, boîte métallique.

Set completo, composto da 6 paia di  
olive, 1 testa adattatore veni, 1 adat-  
tatore Luer, 3 aste, 2 manici, 1 chiave  
a forchetta, contenitore di metallo.



Oliven, Paar  
 Olives, pair  
 Olivas, par  
 Olives, paire  
 Olive, paio



**55.08.85**  
5 mm



**55.08.86**  
6 mm



**55.08.93**

Venenaufsatz  
 Vein tip  
 Punta para vena  
 Embout pour veines  
 Inserto per vena



**55.08.94**

Luer Adapter  
 Adapter  
 Adaptador  
 Adaptateur  
 Adattatore



**55.08.87**  
7 mm



**55.08.88**  
8 mm



**55.08.90**  
10 mm



**55.08.92**  
12 mm

Tunnelierschäfte  
 Tunneling shafts  
 Vástagos de tunelización  
 Tiges de tunnelisation  
 Guaine di tunnelizzazione



**55.08.81**

Griff, Paar  
 Handle, pair  
 Mango, par  
 Manche, paire  
 Manico, paio



**55.08.82**  
24,5 cm



**55.08.83**  
24,5 cm



**55.08.84**  
55,5 cm



**55.08.95**

Gabelschlüssel  
 Wrench  
 Llave  
 Clé  
 Chiave a forchetta

**55.08.97**  
 Etui allein  
 Case only  
 Caja suelta  
 Boîte seule  
 Scatola sola



**Aortastanzen**  
**Aorta Punches**  
**Perforadoras para aorta**  
**Perforateurs pour l'aorte**  
**Perforatori per aorta**

18

a = x



- |                 |      |
|-----------------|------|
| <b>55.08.14</b> | a    |
| <b>55.08.15</b> | 4 mm |
| <b>55.08.16</b> | 5 mm |
| 15 cm – 6"      | 6 mm |



**55.08.21**  
21 cm – 8¼"  
**Merz**

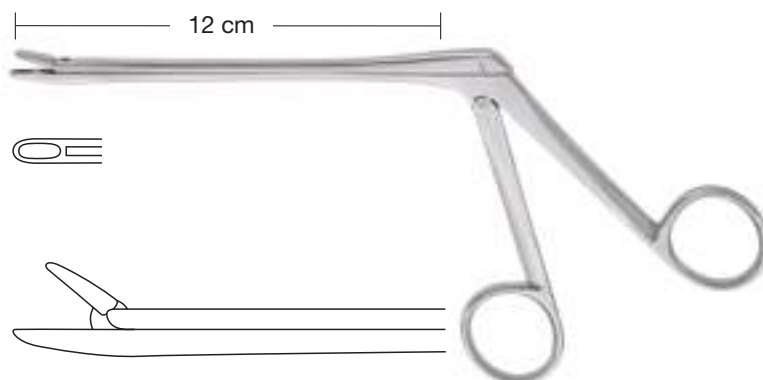

**55.08.30**  
3 mm  
**Bailey**



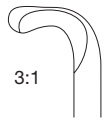

3:1

2,5 mm

retrograd  
 retrograde  
 retrogrado  
 retrograde  
 retrogrado



**55.08.07**  
 24 cm – 9½"

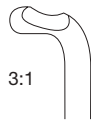

3:1

1,75 mm

antegrad  
 antegrade  
 antegrado  
 antegrade  
 antegrado



**55.08.08**  
 16 cm – 6¼"

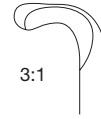

3:1

2 mm

retrograd  
 retrograde  
 retrogrado  
 retrograde  
 retrogrado



**55.08.09**  
 30 cm – 11¾"

Siebvorschläge  
Set Suggestions  
Proposición de juegos  
Propositions de boîtes  
Proposte di set



**Thorakotomie-Sieb**  
**Thoracotomy Set**  
**Juego para toracotomía**  
**Boîte pour thoracotomie**  
**Set per toracotomia**

Pos	Art. No.	Description	req. Qty.
1	<b>04.33.73</b>	NELSON SCRS HM CVD 23CM	1
2	<b>04.33.76</b>	NELSON SCRS HM CVD 26CM	1
3	<b>06.54.24</b>	DEBAKEY TISSUE FCPS 24CM 2.8MM WIDE	2
4	<b>07.17.23</b>	TUTTLE SINGLEY TISSUE FCPS 23CM	2
5	<b>09.85.05</b>	YANKAUER SUCT TUBE W CUT OFF	1
6	<b>09.86.10</b>	COOLEY SUCT TUBE 36CM	1
7	<b>10.20.70</b>	CRILE WOOD NH HM 20CM	2
8	<b>10.20.73</b>	CRILE WOOD NH HM 23CM	2
9	<b>15.73.14</b>	CRILE HEMOST FCPS 14CM CVD	12
10	<b>16.11.16</b>	ROCHESTER PEAN FCPS 16CM CVD	12
11	<b>17.36.70</b>	DUVAL GRASP FCPS 23CM 20MM JAWS	4
12	<b>17.55.08</b>	BACKHAUS TOWEL CLAMP 8.5CM	12
13	<b>22.34.08</b>	VOLKMANN RETR 8 PRG SH	2
14	<b>23.06.16</b>	LANGENBECK RETR 16X42MM	2
15	<b>23.70.62</b>	HARRINGTON RETR 2 62X127MM	2
16	<b>31.31.83</b>	STILLE RONG ANG TO SIDE 23CM	1
17	<b>33.71.27</b>	LISTON STILLE BONE FCPS 27CM CVD	1
18	<b>33.75.27</b>	LISTON KEY BONE FCPS 27CM ANG	1
19	<b>35.05.23</b>	VAN BUREN SEQUESTRUM CLAMP 23CM	1
20	<b>54.18.90</b>	LEBSCHER STERNAL CHISEL 25CM	1
21	<b>54.23.03</b>	FINOCHIETTO RIB SPREADER LARGE	1
22	<b>54.25.40</b>	BAILEY RIB CONTRACTOR ADULT	2
23	<b>54.30.11</b>	DOYEN RIB RASPATORY RT	1
24	<b>54.30.12</b>	DOYEN RIB RASPATORY LF	1
25	<b>54.31.35</b>	ALEXANDER COSTAL PERIOSTEOTOME	1
26	<b>54.35.90</b>	DAVIDSON SCAPULAR RETR 90MM	1
27	<b>55.40.05</b>	DEBAKEY AT CLAMP STR 22CM	2
28	<b>55.60.07</b>	DEBAKEY AT ANEURYSM CLAMP 26CM	1
29	<b>55.70.55</b>	DEBAKEY AT OCCL CLAMP 25.5CM	2



In diesem Katalog nicht abgebildete Instrumente finden Sie in unserem Hauptkatalog.

Instruments not illustrated in this catalogue, please refer to our general catalogue.

Los instrumentos no ilustrados en este catálogo se encuentran en nuestro catálogo general.

Les instruments non-illustrés dans ce catalogue vous trouverez dans notre catalogue général.

Gli strumenti non illustrati in questo catalogo li trovate nel nostro catalogo generale.

**Thorakotomie-Pädiatrie-Sieb**  
**Thoracotomy Pediatric Set**  
**Juego para la toracotomía pediátrica**  
**Boîte pour la thoracotomie pédiatrique**  
**Set per la toracotomia pediatrica**



Pos	Art. No.	Description	req. Qty.
1	<b>04.35.64</b>	METZENBAUM SLIM SCRS HM CVD 14CM	1
2	<b>04.35.68</b>	METZENBAUM SLIM SCRS HM CVD 18CM	1
3	<b>06.00.16</b>	DRESS FCPS 16CM STAND	2
4	<b>06.05.16</b>	TISSUE FCPS 16CM 1X2T STAND	2
5	<b>10.20.68</b>	CRILE WOOD NH HM18CM	2
6	<b>15.45.12</b>	HALSTED MOSQUITO HEMOST FCPS 12.5CM CVD	12
7	<b>15.73.84</b>	COLLER CRILE HEMOST FCPS 14CM CVD	12
8	<b>16.12.14</b>	KOCHER FCPS 1X2T 14CM STR	6
9	<b>17.06.14</b>	MIXTER BABY HEMOST FCPS 14CM	6
10	<b>17.10.19</b>	LAHEY FCPS DELI 19CM CVD	6
11	<b>17.55.08</b>	BACKHAUS TOWEL CLAMP 8.5CM	6
12	<b>22.35.04</b>	VOLKMANN RETR 4 PRG BL	2
13	<b>23.25.01</b>	LANGENBECK RETR 1 7X20MM	2
14	<b>23.70.24</b>	HARRINGTON BABY RETR 24X70MM	2
15	<b>23.73.25</b>	DEAVER RETR HOLLOW HDL 25MM	2
16	<b>31.05.03</b>	RUSKIN MINI BONE RONG 3MM CVD	1
17	<b>31.06.05</b>	RUSKIN BONE RONG STR 18CM	1
18	<b>33.50.15</b>	LISTON MINI BONE CUT FCPS 15CM STR	1
19	<b>33.54.18</b>	RUSKIN ROWLAND BONE FCPS 18CM STR	1
20	<b>33.59.18</b>	MCINDOE BONE CUT FCPS 18CM CVD	1
21	<b>54.22.61</b>	FINOCHIETTO BABY RIB SPREADER	1
22	<b>54.23.11</b>	FINOCHIETTO RIB SPREADER SMALL	1
23	<b>54.25.40</b>	BAILEY RIB CONTRACTOR ADULT	1
24	<b>54.30.01</b>	DOYEN RIB RASPATORY RT	1
25	<b>54.30.02</b>	DOYEN RIB RASPATORY LF	1
26	<b>54.31.30</b>	MATSON RIB STRIPPER	1

**Lungen-Lobektomie- und Resektions-Sieb**  
**Lung Lobectomy and Resection Set**  
**Juego para lobectomía y resección**  
**Boîte pour lobectomie et résection**  
**Set per lobectomia e resezione**

Pos	Art. No.	Description	req. Qty.
1	<b>04.33.76</b>	NELSON SCRS HM CVD 26CM	1
2	<b>16.15.74</b>	SAROT ARTERY FCPS 24CM CVD	2
3	<b>17.12.22</b>	MIXTER RT ANG CLAMP 22CM	2
4	<b>17.36.70</b>	DUVAL GRASP FCPS 23CM 20MM JAWS	2
5	<b>50.03.19</b>	ALLIS TISSUE FCPS 19CM	6
6	<b>54.23.43</b>	BURFORD FINOCHIETTO RIB SPREADER	1
7	<b>54.55.23</b>	SEMB LIG FCPS SLIGHT CVD	2
8	<b>54.57.51</b>	SAROT BRONCHUS FCPS LF	2
9	<b>54.57.52</b>	SAROT BRONCHUS FCPS RT	2
10	<b>55.22.11</b>	HOEPFNER CARDIOVASC CLAMP	2



**Basis-Kardiovaskular-Set**  
**Basic Cardiovascular Set**  
**Juego básico cardiovascular**  
**Boîte de base cardio-vasculaire**  
**Set cardio-vasculare di base**

Pos	Art. No.	Description	req. Qty.
1	01.27.03	SCALPEL HDL NO 3 STAND	1
2	01.27.13	SCALPEL HDL NO 3L LONG	1
3	01.28.04	SCALPEL HDL NO 4 STAND	1
4	03.50.67	MAYO SCRS HM STR 17CM	1
5	03.51.67	MAYO SCRS HM CVD 17CM	1
6	06.00.15	DRESS FCPS 15CM STAND	1
7	06.00.20	DRESS FCPS 20CM STAND	2
8	06.00.25	DRESS FCPS 25CM STAND	1
9	06.46.18	POTTS SMITH DRESS FCPS 18CM SERR	2
10	06.46.25	POTTS SMITH DRESS FCPS 25CM SERR	2
11	06.50.15	DEBAKEY TISSUE FCPS 15.0CM 1.5MM WIDE	2
12	06.52.15	DEBAKEY TISSUE FCPS 15.0CM 2.0MM WIDE	2
13	06.52.19	DEBAKEY TISSUE FCPS 19.5CM 2.0MM WIDE	2
14	06.52.24	DEBAKEY TISSUE FCPS 24.0CM 2.0MM WIDE	2
15	07.15.25	RUSSIAN TISSUE FCPS 25.0CM	2
16	09.83.58	FRAZIER SUCT TUBE 8 FR ANG 18CM	1
17	09.85.00	YANKAUER SUCT TUBE	2
18	09.86.16	COOLEY INTRACARDIAC SUCT TUBE 30CM	1
19	09.96.71	LEMMON VASC SPATULA SLIGHT CVD 17CM 3MM	2
20	09.96.72	LEMMON VASC SPATULA MED CVD 17CM 3MM	2
21	10.20.68	CRILE WOOD NH HM 18CM	2
22	10.20.73	CRILE WOOD NH HM 23CM	2
23	10.20.75	CRILE-WOOD NH HM 25CM	2
24	15.45.12	HALSTED MOSQUITO HEMOST FCPS 12.5CM CVD	10
25	15.73.14	CRILE HEMOST FCPS 14CM CVD	10
26	15.73.16	CRILE RANKIN HEMOST FCPS 16CM CVD	10
27	16.11.20	ROCHESTER PEAN FCPS 20CM CVD	4
28	16.11.24	ROCHESTER PEAN FCPS 24CM CVD	2
29	16.13.24	ROCH OCHSNER FCPS 1X2T 24CM CVD	4
30	16.15.24	CRAFOORD HEMOST FCPS 24CM CVD	4
31	17.07.18	MIXTER ARTERY FCPS 18CM	2
32	17.07.23	MIXTER ARTERY FCPS 23CM	1
33	17.36.45	DUVAL GRASP FCPS 21CM 15MM JAWS	2
34	17.36.50	DUVAL GRASP FCPS 21CM 20MM JAWS	2
35	17.55.13	BACKHAUS TOWEL CLAMP 13CM	12
36	17.72.16	PRESBYT HOSPITAL TUBING CLAMP 16CM	6
37	19.50.24	FOERSTER SPONGE FCPS 24CM STR	6
38	19.51.24	FOERSTER SPONGE FCPS 24CM CVD	6
39	20.17.50	CUSHING VEIN HOOK 10X10 MM BLADE	2
40	22.02.53	SPATULA MALLE 3X33CM	2
41	22.18.21	PARKER LANGENBECK RETR SET/2	2
42	22.34.06	VOLKMANN RETR 6 PRG SH	2
43	23.21.25	KOCHER RETR 25X60MM	2
44	23.21.40	KOCHER RETR 40X75MM	2
45	23.75.04	DEAVER RETR 1 25MMX30CM	2
46	54.15.01	BRUNNER RIB SHEARS FIG 1 LF	1
47	54.23.61	COOLEY STERN SPREADER CHILDREN ALU	1
48	54.23.63	COOLEY STERN SPREADER ADULTS ALU 230	1



Pos	Art. No.	Description	req. Qty.
49	<b>54.25.50</b>	BAILEY GIBBON RIB CONTRACTOR	1
50	<b>54.31.35</b>	ALEXANDER COSTAL PERIOSTEOTOME	1
51	<b>54.55.23</b>	SEMB LIG FCPS SLIGHT CVD	1
52	<b>55.09.90</b>	RUMEL BELMONT TOURNIQUET	1
53	<b>55.11.13</b>	COOLEY ATRIUM RETR 25X46MM LF	1
54	<b>55.11.16</b>	COOLEY ATRIUM RETR 45X35MM SERR	1
55	<b>55.13.50</b>	SATINSKY SCRS 24CM	1
56	<b>55.13.75</b>	DEBAKEY ENDARTERECTOMY SCRS 18CM	1
57	<b>55.22.11</b>	HOEPFNER CARDIOVASC CLAMP*	2
58	<b>55.50.16</b>	DEBAKEY AT PERIPH VASC CLAMP 18.0CM 60°	1
59	<b>55.52.34</b>	DEBAKEY AT PERIPH VASC CLAMP 16.0CM CVD	1
60	<b>55.52.47</b>	DEBAKEY AT PERIPH VASC CLAMP 20.0CM	1
61	<b>55.52.48</b>	DEBAKEY AT PERIPH VASC CLAMP 18.5CM	1
62	<b>55.60.07</b>	DEBAKEY AT ANEURYSM CLAMP 26CM	2
63	<b>55.60.08</b>	DEBAKEY AT ANEURYSM CLAMP 27CM	1
64	<b>55.64.35</b>	DEBAKEY AT ANEURYSM CLAMP 23CM	1
65	<b>55.80.50</b>	DEBAKEY AT M P CLAMP 60° 21CM	1
66	<b>55.82.40</b>	DEBAKEY AT M P CLAMP 90° 22CM	1
67	<b>55.82.50</b>	DEBAKEY AT M P CLAMP 90° 19CM	1
68	<b>57.25.20</b>	STRULLY SCRS 20CM	1
69	<b>204.32.68</b>	SC PLUS METZENBAUM SCRS STR 18CM	1
70	<b>204.33.68</b>	SC PLUS METZENBAUM SCRS CVD 18CM	1
71	<b>204.33.73</b>	SC PLUS NELSON SCRS CVD 23CM	1
72	<b>255.15.42</b>	SC POTTS SMITH VASC SCRS 25° 19CM	1
73	<b>255.15.44</b>	SC POTTS SMITH VASC SCRS 45° 19CM	1
74	<b>255.15.46</b>	SC POTTS SMITH VASC SCRS 60° 19CM	1



**Aorta-Koarktations-Sieb**  
**Aorta Coarctation Set**  
**Juego para coarctación de aorta**  
**Boîte pour coarctation de l'aorte**  
**Set per coarctazione dell'aorta**

Pos	Art. No.	Description	req. Qty.
1	<b>01.27.03</b>	SCALPEL HDL NO 3 STAND	3
2	<b>01.27.13</b>	SCALPEL HDL NO 3L LONG	1
3	<b>03.50.67</b>	MAYO SCRS HM STR 17CM	2
4	<b>03.51.67</b>	MAYO SCRS HM CVD 17CM	2
5	<b>04.33.20</b>	METZENBAUM SCRS CVD 20CM	1
6	<b>04.33.68</b>	METZENBAUM SCRS HM CVD 18CM	1
7	<b>04.33.73</b>	NELSON SCRS HM CVD 23CM	1
8	<b>04.55.16</b>	KELLY SCRS 16CM CVD	1
9	<b>06.05.15</b>	TISSUE FCPS 15CM 1X2T STAND	2
10	<b>06.20.12</b>	ADSON DRESS FCPS 12CM SERR	1
11	<b>06.25.12</b>	ADSON BROWN TISSUE FCPS STR 7X7T	2
12	<b>06.46.18</b>	POTTS SMITH DRESS FCPS 18CM SERR	2
13	<b>06.52.19</b>	DEBAKEY TISSUE FCPS 19.5CM 2.0MM WIDE	4
14	<b>06.52.24</b>	DEBAKEY TISSUE FCPS 24CM 2.0MM WIDE	2
15	<b>07.15.15</b>	RUSSIAN TISSUE FCPS 15CM	2
16	<b>07.15.20</b>	RUSSIAN TISSUE FCPS 20CM	2
17	<b>09.83.10</b>	FRAZIER SUCT TUBE 10FR ANG 12.5CM	1
18	<b>09.85.00</b>	YANKAUER SUCT TUBE	2
19	<b>09.85.05</b>	YANKAUER SUCT TUBE W CUT OFF	2
20	<b>09.88.23</b>	POOLE SUCT TUBE 23FR CVD	1
21	<b>10.18.15</b>	MAYO HEGAR NH 15CM	3
22	<b>10.18.18</b>	MAYO HEGAR NH 18CM	5
23	<b>10.18.20</b>	MAYO HEGAR NH 20CM	3
24	<b>10.20.18</b>	CRILE WOOD NH 18CM	1
25	<b>10.22.68</b>	SAROT NH HM 18CM	1
26	<b>14.23.62</b>	UNIVERSAL WIRE CUT SCRS HM 12CM	2
27	<b>15.16.10</b>	DEBAKEY BULLDOG CLAMP 105MM STR	2
28	<b>15.17.10</b>	DEBAKEY BULLDOG CLAMP 100MM CVD	2
29	<b>15.44.12</b>	HALSTED MOSQUITO HEMOST FCPS 12.5CM STR	1
30	<b>15.45.12</b>	HALSTED MOSQUITO HEMOST FCPS 12.5CM CVD	4
31	<b>15.72.14</b>	CRILE HEMOST FCPS 14CM STR	2
32	<b>15.73.14</b>	CRILE HEMOST FCPS 14CM CVD	2
33	<b>16.11.20</b>	ROCHESTER PEAN FCPS 20CM CVD	1
34	<b>16.12.16</b>	ROCHESTER OCHSNER FCPS 1X2T 16CM STR	2
35	<b>16.15.18</b>	CRAFOORD HEMOST FCPS 18CM CVD	4
36	<b>16.15.24</b>	CRAFOORD HEMOST FCPS 24CM CVD	3
37	<b>16.36.16</b>	CARMALT HEMOST FCPS 16CM STR	2
38	<b>16.51.20</b>	HEISS ARTERY FCPS 21CM CVD	3
39	<b>17.07.18</b>	MIXTER ARTERY FCPS 18CM	2
40	<b>17.55.08</b>	BACKHAUS TOWEL CLAMP 8.5CM	6
41	<b>17.55.13</b>	BACKHAUS TOWEL CLAMP 13CM	6
42	<b>17.73.14</b>	TUBING CLAMP WIDE JAWS SERR 14CM	6
43	<b>19.50.24</b>	FOERSTER SPONGE FCPS 24CM STR	4
44	<b>20.05.08</b>	SENN MILLER RETR SH	2
45	<b>20.17.50</b>	CUSHING VEIN HOOK 10X10 MM BLADE	1
46	<b>22.02.53</b>	SPATULA MALLE 3X33CM	1
47	<b>22.02.54</b>	SPATULA MALLE 4X33CM	1
48	<b>22.02.55</b>	SPATULA MALLE 5X33CM	1

**Aorta-Koarktations-Sieb**  
**Aorta Coarctation Set**  
**Juego para coarctación de aorta**  
**Boîte pour coarctation de l'aorte**  
**Set per coarctazione dell'aorta**



Pos	Art. No.	Description	req. Qty.
49	<b>22.14.18</b>	PARKER RETR 18CM SET/2	1
50	<b>22.18.21</b>	PARKER LANGENBECK RETR SET/2	1
51	<b>22.50.04</b>	MURPHY RETR 4 PRG SH	2
52	<b>23.35.12</b>	GREEN THYROID RETR FENESTR 12X25MM	2
53	<b>23.45.01</b>	RICHARDSON RETR 20X25MM	2
54	<b>23.45.02</b>	RICHARDSON RETR 25X32MM	2
55	<b>23.45.03</b>	RICHARDSON RETR 38X38MM	2
56	<b>23.45.04</b>	RICHARDSON RETR 20X50MM	2
57	<b>23.75.04</b>	DEAVER RETR FIG 1 25MMX30CM	2
58	<b>23.75.07</b>	DEAVER RETR FIG 3 38MMX30CM	2
59	<b>23.75.08</b>	DEAVER RETR FIG 4 50MMX30CM	2
60	<b>23.75.09</b>	DEAVER RETR FIG 5 75MMX30CM	2
61	<b>24.22.13</b>	WEITLANER RETR SH PRG 13CM	1
62	<b>24.40.17</b>	GELPI PERINEAL RETR 17CM	1
63	<b>27.08.57</b>	BERGMANN Mallet SOLID METAL 570G	1
64	<b>50.02.16</b>	ALLIS TISSUE FCPS 15CM 5X6T	4
65	<b>50.02.19</b>	ALLIS TISSUE FCPS 19CM 5X6T	3
66	<b>50.04.15</b>	ADAIR ALLIS TISSUE FCPS 15CM	2
67	<b>50.10.16</b>	BABCOCK TISSUE FCPS 16CM	2
68	<b>54.18.90</b>	LEBSCHKE STERNAL KNIFE 25CM	1
69	<b>54.22.51</b>	FINOCHIETTO BABY RIB SPREADER	1
70	<b>54.23.02</b>	FINOCHIETTO RIB SPREADER MED	1
71	<b>54.23.03</b>	FINOCHIETTO RIB SPREADER LARGE	1
72	<b>54.25.40</b>	BAILEY RIB CONTRACTOR ADULT	1
73	<b>54.30.11</b>	DOYEN RIB RASPATORY RT	1
74	<b>54.30.12</b>	DOYEN RIB RASPATORY LF	1
75	<b>54.31.35</b>	ALEXANDER COSTAL PERIOSTEOTOME	1
76	<b>54.35.90</b>	DAVIDSON SCAPULAR RETR 90MM	1
77	<b>55.09.93</b>	RUMEL BELMONT TOURNIQUET W RAT	1
78	<b>55.15.42</b>	POTTS SMITH VASC SCRS 25° 19CM	1
79	<b>55.15.44</b>	POTTS SMITH VASC SCRS 45° 19CM	1
80	<b>55.22.11</b>	HOEPFNER CARDIOVASC CLAMP*	2
81	<b>55.36.33</b>	DEBAKEY AT M P CLAMP 30° 16CM	1
82	<b>55.36.63</b>	DEBAKEY AT M P CLAMP 60° 15CM	1
83	<b>55.36.93</b>	DEBAKEY AT M P CLAMP 90° 14CM	1
84	<b>55.38.20</b>	DERRA DEBAKEY AT ANASTOM CLAMP 20MM	1
85	<b>55.38.25</b>	DERRA DEBAKEY AT ANASTOM CLAMP 25MM	1
86	<b>55.40.05</b>	DEBAKEY AT CLAMP STR 22CM	2
87	<b>55.40.15</b>	DEBAKEY AT CLAMP ANG 22CM	2
88	<b>55.50.16</b>	DEBAKEY AT PERIPH VASC CLAMP 60° 18CM	1
89	<b>55.64.37</b>	DEBAKEY AT ANEURYSM CLAMP 25CM	1
90	<b>55.70.45</b>	DEBAKEY AT OCCL CLAMP 24.5CM	1
91	<b>55.74.40</b>	SATINSKY DEBAKEY AT CLAMP 40MM JAWS	1
92	<b>55.74.93</b>	GLOVER AURICULAR APPENDAGE CLAMP	1
93	<b>58.30.31</b>	KRAYENBUEHL NERVE HOOK SMALL	2
94	<b>58.30.32</b>	KRAYENBUEHL NERVE HOOK LARGE	1





**Mitral-Kommissurotomie-Sieb**  
**Mitral Commissurotomy Set**  
**Juego para comisurotomía mitral**  
**Boîte pour la commissurotomie mitrale**  
**Set per la commisuratomia mitrale**

Pos	Art. No.	Description	req. Qty.
1	<b>01.27.03</b>	SCALPEL HDL NO 3 STAND	3
2	<b>01.27.13</b>	SCALPEL HDL NO 3L LONG	1
3	<b>03.50.67</b>	MAYO SCRS HM STR 17CM	2
4	<b>03.51.67</b>	MAYO SCRS HM CVD 17CM	2
5	<b>04.33.20</b>	METZENBAUM SCRS CVD 20CM	1
6	<b>04.33.68</b>	METZENBAUM SCRS HM CVD 18CM	1
7	<b>04.33.73</b>	NELSON SCRS HM CVD 23CM	1
8	<b>04.55.16</b>	KELLY SCRS 16CM CVD	1
9	<b>06.05.15</b>	TISSUE FCPS 15CM 1X2T STAND	2
10	<b>06.20.12</b>	ADSON DRESS FCPS 12CM SERR	1
11	<b>06.25.12</b>	ADSON BROWN TISSUE FCPS STR 7X7T	2
12	<b>06.46.18</b>	POTTS SMITH DRESS FCPS 18CM SERR	2
13	<b>06.52.19</b>	DEBAKEY TISSUE FCPS 19.5CM 2.0MM WIDE	4
14	<b>06.52.24</b>	DEBAKEY TISSUE FCPS 24.0CM 2.0MM WIDE	2
15	<b>07.15.15</b>	RUSSIAN TISSUE FCPS 15CM	2
16	<b>07.15.20</b>	RUSSIAN TISSUE FCPS 20CM	2
17	<b>09.83.10</b>	FRAZIER SUCT TUBE 10FR ANG 12.5CM	1
18	<b>09.85.00</b>	YANKAUER SUCT TUBE	2
19	<b>09.85.05</b>	YANKAUER SUCT TUBE W CUT OFF	2
20	<b>09.88.23</b>	POOLE SUCT TUBE 23FR CVD	1
21	<b>10.18.15</b>	MAYO HEGAR NH 15CM	3
22	<b>10.18.18</b>	MAYO HEGAR NH 18CM	5
23	<b>10.18.20</b>	MAYO HEGAR NH 20CM	3
24	<b>10.20.18</b>	CRILE WOOD NH 18CM	1
25	<b>10.22.68</b>	SAROT NH HM 18CM	1
26	<b>14.23.62</b>	UNIVERSAL WIRE CUT SCRS HM 12CM	2
27	<b>15.44.12</b>	HALSTED MOSQUITO HEMOST FCPS 12.5CM STR	1
28	<b>15.45.12</b>	HALSTED MOSQUITO HEMOST FCPS 12.5CM CVD	4
29	<b>15.72.14</b>	CRILE HEMOST FCPS 14CM STR	2
30	<b>15.73.14</b>	CRILE HEMOST FCPS 14CM CVD	2
31	<b>16.11.20</b>	ROCHESTER PEAN FCPS 20CM CVD	1
32	<b>16.12.16</b>	ROCH OCHSNER FCPS 1X2T 16CM STR	2
33	<b>16.15.18</b>	CRAFOORD HEMOST FCPS 18CM CVD	4
34	<b>16.15.24</b>	CRAFOORD HEMOST FCPS 24CM CVD	3
35	<b>16.36.16</b>	CARMALT HEMOST FCPS 16CM STR	2
36	<b>16.51.20</b>	HEISS ARTERY FCPS 21CM CVD	3
37	<b>17.07.18</b>	MIXTER ARTERY FCPS 18CM	2
38	<b>17.55.08</b>	BACKHAUS TOWEL CLAMP 8.5CM	6
39	<b>17.55.13</b>	BACKHAUS TOWEL CLAMP 13CM	6
40	<b>17.73.14</b>	TUBING CLAMP WIDE JAWS SERR 14CM	6
41	<b>19.50.24</b>	FOERSTER SPONGE FCPS 24CM STR	4
42	<b>20.05.08</b>	SENN MILLER RETR SH	2
43	<b>20.17.50</b>	CUSHING VEIN HOOK 10X10 MM BLADE	1
44	<b>22.02.53</b>	SPATULA MALLE 3X33CM	1
45	<b>22.02.54</b>	SPATULA MALLE 4X33CM	1
46	<b>22.02.55</b>	SPATULA MALLE 5X33CM	1
47	<b>22.14.18</b>	PARKER RETR 18CM SET/2	1
48	<b>22.18.21</b>	PARKER LANGENBECK RETR SET/2	1

**Mitral-Kommissurotomie-Sieb**  
**Mitral Commissurotomy Set**  
**Juego para comisurotomía mitral**  
**Boîte pour la commissurotomie mitrale**  
**Set per la commissuratomia mitrale**



Pos	Art. No.	Description	req. Qty.
49	<b>22.50.04</b>	MURPHY RETR 4 PRG SH	2
50	<b>23.35.12</b>	GREEN THYROID RETR FENESTR 12X25MM	2
51	<b>23.45.01</b>	RICHARDSON RETR 20X25MM	2
52	<b>23.45.02</b>	RICHARDSON RETR 25X32MM	2
53	<b>23.45.03</b>	RICHARDSON RETR 38X38MM	2
54	<b>23.45.04</b>	RICHARDSON RETR 20X50MM	2
55	<b>23.75.04</b>	DEAVER RETR FIG 1 25MMX30CM	2
56	<b>23.75.07</b>	DEAVER RETR FIG 3 38MMX30CM	2
57	<b>23.75.08</b>	DEAVER RETR FIG 4 50MMX30CM	2
58	<b>23.75.09</b>	DEAVER RETR FIG 5 75MMX30CM	2
59	<b>24.22.13</b>	WEITLANER RETR SH PRG 13CM	1
60	<b>24.40.17</b>	GELPI PERINEAL RETR 17CM	1
61	<b>27.08.57</b>	BERGMANN MALLET SOLID METAL 570G	1
62	<b>50.02.16</b>	ALLIS TISSUE FCPS 15CM 5X6T	4
63	<b>50.02.19</b>	ALLIS TISSUE FCPS 19CM 5X6T	3
64	<b>50.04.15</b>	ADAIR ALLIS TISSUE FCPS 15CM	2
65	<b>50.10.16</b>	BABCOCK TISSUE FCPS 16CM	2
66	<b>54.18.90</b>	LEBSCHKE STERNAL KNIFE 25CM	1
67	<b>54.22.51</b>	FINOCHIETTO BABY RIB SPREADER	1
68	<b>54.23.02</b>	FINOCHIETTO RIB SPREADER MED	1
69	<b>54.23.03</b>	FINOCHIETTO RIB SPREADER LARGE	1
70	<b>54.25.40</b>	BAILEY RIB CONTRACTOR ADULT	1
71	<b>54.30.11</b>	DOYEN RIB RASPATORY RT	1
72	<b>54.30.12</b>	DOYEN RIB RASPATORY LF	1
73	<b>54.31.35</b>	ALEXANDER COSTAL PERIOSTEOTOME	1
74	<b>54.35.90</b>	DAVIDSON SCAPULAR RETR 90MM	1
75	<b>55.08.07</b>	VALVULOTOME RETROGRADE 2.5MM 24CM	1
76	<b>55.08.08</b>	VALVULOTOME ANTEGRADE 1.75MM 16CM	1
77	<b>55.08.09</b>	MILLS VALVULOTOME RETROGRADE 2MM 30CM	1
78	<b>55.08.70</b>	TUBBS DILATOR	1
79	<b>55.09.93</b>	RUMEL BELMONT TOURNIQUET W RAT	1
80	<b>55.15.42</b>	POTTS SMITH VASC SCRS 25° 19CM	1
81	<b>55.15.44</b>	POTTS SMITH VASC SCRS 45° 19CM	1
82	<b>55.22.11</b>	HOEPFNER CARDIOVASC CLAMP	2
83	<b>55.36.33</b>	DEBAKEY AT M P CLAMP 30° 16CM	1
84	<b>55.36.63</b>	DEBAKEY AT M P CLAMP 60° 15CM	1
85	<b>55.36.93</b>	DEBAKEY AT M P CLAMP 90° 14CM	1
86	<b>55.38.20</b>	DERRA DEBAKEY AT ANASTOM CLAMP 20MM	1
87	<b>55.38.25</b>	DERRA DEBAKEY AT ANASTOM CLAMP 25MM	1
88	<b>55.50.16</b>	DEBAKEY AT PERIPH VASC CLAMP 60° 18CM	1
89	<b>55.64.37</b>	DEBAKEY AT ANEURYSM CLAMP 25CM	1
90	<b>55.70.45</b>	DEBAKEY AT OCCL CLAMP 24.5CM	1
91	<b>55.74.40</b>	SATINSKY DEBAKEY AT CLAMP 40MM JAWS	1
92	<b>55.74.93</b>	GLOVER AURICULAR APPENDAGE CLAMP	1
93	<b>58.30.31</b>	KRAYENBUEHL NERVE HOOK SMALL	2
94	<b>58.30.32</b>	KRAYENBUEHL NERVE HOOK LARGE	1



**Koronarie- und Katheterisierung-Sieb**  
**Coronary Set and Catheterization Set**  
**Juego para cirugía coronaria y para cateterización**  
**Boîte pour chirurgie coronaire et pour cathéterisation**  
**Set per chirurgia coronaria e per cateterizzazione**

19

Pos	Art. No.	Description	req. Qty.
1	<b>06.46.18</b>	POTTS SMITH DRESS FCPS 18CM SERR	2
2	<b>06.46.20</b>	POTTS SMITH DRESS FCPS 20CM SERR	2
3	<b>09.96.71</b>	LEMMON VASC SPATULA SLIGHT CVD 17CM 3MM	1
4	<b>09.96.72</b>	LEMMON VASC SPATULA MED CVD 17CM 3MM	1
5	<b>09.96.73</b>	LEMMON VASC SPATULA STRONG CVD 17CM 3MM	1
6	<b>10.26.68</b>	RYDER (FRENCH EYE) NH HM 18CM	1
7	<b>10.26.73</b>	RYDER (FRENCH EYE) NH HM 23CM	1
8	<b>15.07.31</b>	TI BULLDOG CLAMP 3CM STRONG CVD A	3
9	<b>15.16.07</b>	DEBAKEY BULLDOG CLAMP 75MM STR	1
10	<b>15.17.07</b>	DEBAKEY BULLDOG CLAMP 70MM CVD	1
11	<b>17.06.19</b>	MIXTER BABY HEMOST FCPS 19CM	1
12	<b>20.17.50</b>	CUSHING VEIN HOOK 10X10 MM BLADE	2
13	<b>24.30.17</b>	WEITL BECKMANN RETR BL 17.0CM	1
14	<b>55.10.05</b>	DEBAKEY VASCULAR DILATOR 0.5MM	1
15	<b>55.10.10</b>	DEBAKEY VASCULAR DILATOR 1.0MM	1
16	<b>55.10.15</b>	DEBAKEY VASCULAR DILATOR 1.5MM	1
17	<b>55.10.20</b>	DEBAKEY VASCULAR DILATOR 2.0MM	1
18	<b>55.15.40</b>	HEGEMANN VASCULAR SCRS 125° 18CM	1
19	<b>55.35.47</b>	COOLEY AT VASCULAR CLAMP 17CM	1
20	<b>55.74.50</b>	SATINSKY DEBAKEY AT CLAMP 50MM JAWS	1
21	<b>204.35.68</b>	SC PLUS METZENB SLIM SCRS CVD 18CM	1
22	<b>225.15.34</b>	MC HEGEMANN DIETRICH VASC SCRS 45° 18CM	1
23	<b>225.15.36</b>	MC HEGEMANN DIETRICH VASC SCRS 60° 18CM	1
24	<b>225.15.39</b>	MC HEGEMANN DIETRICH VASC SCRS 90° 18CM	1

Pos	Art. No.	Description	req. Qty.
1	<b>01.27.03</b>	SCALPEL HDL NO 3 STAND	1
2	<b>03.04.14</b>	SURG SCRS STR 14.5CM SH/SH	1
3	<b>06.20.62</b>	ADSON TISSUE FCPS HM 12CM	1
4	<b>06.21.62</b>	ADSON TISSUE FCPS HM 12CM 1X2T	1
5	<b>10.20.64</b>	BABY CRILE WOOD NH HM 15CM	1
6	<b>10.20.68</b>	CRILE WOOD NH HM18CM	1
7	<b>15.45.12</b>	HALSTED MOSQUITO HEMOST FCPS 12.5CM CVD	6
8	<b>15.73.14</b>	CRILE HEMOST FCPS 14CM CVD	6
9	<b>17.07.36</b>	MIXTER ARTERY FCPS 16CM	2
10	<b>17.55.08</b>	BACKHAUS TOWEL CLAMP 8.5CM	6
11	<b>19.50.18</b>	BALLENGER SPONGE FCPS 18CM STR	2
12	<b>20.05.08</b>	SENN MILLER RETR SH	2
13	<b>20.30.19</b>	GILLIES DURA & SKIN HOOK SMALL	2
14	<b>20.50.05</b>	JOSEPH DOUBLE HOOK 5MM	2
15	<b>24.40.57</b>	GELPI PERINEAL RETR W BALL STOPS	1
16	<b>55.15.44</b>	POTTS SMITH VASC SCRS 45° 19CM	1
17	<b>55.50.16</b>	DEBAKEY AT PERIPH VASC CLAMP 60° 18CM	2
18	<b>202.20.11</b>	SC IRIS SCRS STR 11.5CM	1
19	<b>204.33.14</b>	SC METZENBAUM SCRS CVD 14CM	1

**Endarterektomie-Sieb  
Endarterectomy Set  
Juego para endarterectomia  
Boîte pour endartérectomie  
Set per endarterectomía**



Pos	Art. No.	Description	req. Qty.
1	<b>01.27.03</b>	SCALPEL HDL NO 3 STAND	1
2	<b>02.22.61</b>	IRIS SCRS HM STR 11.5CM	1
3	<b>06.50.15</b>	DEBAKEY TISSUE FCPS 15.0CM 1.5MM WIDE	2
4	<b>06.50.19</b>	DEBAKEY TISSUE FCPS 19.5CM 1.5MM WIDE	1
5	<b>06.50.24</b>	DEBAKEY TISSUE FCPS 24.0CM 1.5MM WIDE	1
6	<b>06.60.69</b>	CUSHING TISSUE FCPS HM 18CM ANG	2
7	<b>09.04.14</b>	D/E PROBE 1.5MM 14.5CM	2
8	<b>09.83.78</b>	FRAZIER SUCT TUBE 8 FR ANG 18CM	1
9	<b>09.96.02</b>	ENDARTERECTOMY STRIPPER 2.0MM	2
10	<b>09.96.03</b>	ENDARTERECTOMY STRIPPER 3.0MM	2
11	<b>09.96.04</b>	ENDARTERECTOMY STRIPPER 4.0MM	2
12	<b>09.96.06</b>	ENDARTERECTOMY STRIPPER 6.0MM	2
13	<b>09.96.07</b>	ENDARTERECTOMY STRIPPER 7.0MM	2
14	<b>09.96.08</b>	ENDARTERECTOMY STRIPPER 8.5MM	2
15	<b>09.96.10</b>	ENDARTERECTOMY STRIPPER 10MM	2
16	<b>09.96.12</b>	ENDARTERECTOMY STRIPPER 12MM	2
17	<b>09.96.14</b>	ENDARTERECTOMY STRIPPER 14MM	2
18	<b>09.96.19</b>	HDL F STRIPPERS 09.96.02 09.96.14	2
19	<b>09.96.71</b>	LEMMON VASC SPATULA SLIGHT CVD 17CM 3MM	1
20	<b>10.20.68</b>	CRILE WOOD NH HM18CM	1
21	<b>10.20.73</b>	CRILE WOOD NH HM 23CM	1
22	<b>15.16.10</b>	DEBAKEY BULLDOG CLAMP 105MM STR	4
23	<b>15.17.07</b>	DEBAKEY BULLDOG CLAMP 70MM CVD	4
24	<b>15.17.10</b>	DEBAKEY BULLDOG CLAMP 100MM CVD	4
25	<b>15.17.12</b>	DEBAKEY BULLDOG CLAMP 115MM CVD	4
26	<b>15.41.12</b>	MICRO HALSTED HEMOST FCPS CVD	6
27	<b>15.46.12</b>	HALSTED MOSQUITO HEMOST FCPS 1X2T STR	6
28	<b>17.55.13</b>	BACKHAUS TOWEL CLAMP 13CM	4
29	<b>19.50.24</b>	FOERSTER SPONGE FCPS 24CM STR	2
30	<b>20.22.37</b>	CUSHING NERVE HOOK 6MMM 28CM	1
31	<b>24.22.17</b>	WEITLANER RETR BL PR 16.5CM	1
32	<b>24.34.26</b>	BECKMANN ADSON RETR 4X4PR/25MM BL	1
33	<b>55.15.42</b>	POTTS SMITH VASC SCRS 25° 19CM	1
34	<b>55.15.44</b>	POTTS SMITH VASC SCRS 45° 19CM	1
35	<b>55.15.46</b>	POTTS SMITH VASC SCRS 60° 19CM	1
36	<b>55.22.11</b>	HOEPFNER CARDIOVASC CLAMP*	2
37	<b>55.44.35</b>	GLOVER DEBAKEY AT CLAMP CVD 22CM	1
38	<b>55.60.07</b>	DEBAKEY AT ANEURYSM CLAMP 26CM	1
39	<b>55.64.55</b>	SEMB DEBAKEY AT LIG CLAMP 26.5CM	1
40	<b>55.74.32</b>	SATINSKY DEBAKEY AT CLAMP 32MM JAWS	1
41	<b>55.74.40</b>	SATINSKY DEBAKEY AT CLAMP 40MM JAWS	1
42	<b>204.34.18</b>	SC METZENBAUM SLIM SCRS STR 18CM	2
43	<b>204.35.18</b>	SC METZENBAUM SLIM SCRS CVD 18CM	2



**Venenstripping-Sieb**  
**Vein Stripper Set**  
**Juego para extracción de venas**  
**Boîte pour extraction des varices**  
**Set per la disobliterazione di vene**

Pos	Art. No.	Description	req. Qty.
1	<b>06.30.15</b>	SEMKEN DRESS FCPS STR 15CM SERR	2
2	<b>06.31.15</b>	SEMKEN TISS FCPS STR 15CM 1X2T	2
3	<b>09.95.00</b>	NABATOFF VEIN STRIPPER I/METAL CASE	1
4	<b>10.18.65</b>	MAYO HEGAR NH HM 15CM	1
5	<b>15.41.12</b>	MICRO HALSTED HEMOST FCPS CVD	4
6	<b>15.71.14</b>	KELLY HEMOST FCPS 14CM CVD	8
7	<b>15.73.14</b>	CRILE HEMOST FCPS 14CM CVD	8
8	<b>17.55.13</b>	BACKHAUS TOWEL CLAMP 13CM	6
9	<b>20.05.09</b>	SENN MILLER RETR BL	2
10	<b>22.10.15</b>	FARABEUF RETR 16/19MM SET/2	1
11	<b>22.34.54</b>	VOLKMANN RETR 4 PRG SEMISH	2
12	<b>24.22.17</b>	WEITLANER RETR BL PR 16.5CM	1
13	<b>49.50.10</b>	MEDICONTAINER 290X290X100MM SILVER	1
14	<b>202.23.61</b>	SC PLUS IRIS SCRS CVD 11.5CM	1
15	<b>204.33.64</b>	SC PLUS METZENBAUM SCRS CVD 14CM	1

19

Instruments

**20**

**medicon**

**Zubehör  
Accessories  
Accesorios  
Accessoires  
Accessori**



**Zubehör**  
**Accessories**  
**Accesorios**  
**Accessoires**  
**Accessori**

**Instrumenten-Tray**  
**Instrument Tray**  
**Bandeja de plástico**  
**Plateau de stérilisation**  
**Cassetta per strumenti**

mit Silikonmatte  
including silicone mat  
con tapa de silicona  
avec tapis en silicone  
tappetino in silicone



**49.90.00**  
190 T 102 T 19 mm

**49.90.02**  
280 T 170 T 55 mm



Lieferung ohne Instrumente  
Supplied without instruments  
Entrega sin instrumentos  
Livraison sans instruments  
Fornitura senza strumenti

- Für eine schonende Aufbereitung und Lagerung von feinen und empfindlichen Instrumenten, wie z.B. mikrochirurgischen Instrumenten und feinen Häkchen. Die Trays können in Sterilisiercontainern, z.B. MEDICONTAINER, zusammen mit dem übrigen Instrumentarium sterilisiert und aufbewahrt werden.
- autoklavierbar bei 134°C
- geringes Gewicht
- einfaches und sicheres Verschlusssystem
- stapelbar

- For a careful sterilization and storage of fine and delicate instruments, for example micro surgery instruments and fine hooks. The trays may be sterilized and stored together with the instruments in sterilizing containers, for example MEDICONTAINERS.
- autoclavable up to 134°C
- low weight
- simple and secure locking system
- stackable

- Para un tratamiento cuidadoso y para almacenamiento de instrumentos delicados como p.ej. micro instrumentos y separadores finos. Las bandejas pueden ser esterilizadas y almacenadas en un contenedor para la esterilización, p.ej. los MEDICONTAINERS.
- autoclavable con 134°C
- ligero
- cierre fácil y seguro
- apilable

- Pour une préparation et un stockage avec ménagement des instruments fins et délicats, comme p.ex. des instruments microchirurgicaux et des crochets fins. Les plateaux peuvent être stérilisés et rangés dans des containers de stérilisation comme p.ex. des MEDICONTAINERS, ensemble avec d'autre instrumentation.
- autoclavable à 134°C
- poids réduit
- système de fermeture simple et sûr
- empilable

- Per una accurata preparazione e magazzinaggio di strumenti delicati e fini, come p.e. strumenti per la microchirurgia ed uncini delicati. Le cassette possono essere sterilizzate e immagazzinate in contenitori per sterilizzazione, come p.e. i nostri MEDICONTAINER, insieme ad altri strumenti.
- autoclavabile a 134°C
- leggera
- sistema di chiusura facile e sicura
- impilabile



**46.00.40**  
400 ml

Sprühöl zur Pflege chirurgischer Instrumente  
Spray oil for the care of surgical instruments  
Aceite de rociado pulverizado para cuidar instrumentos quirúrgicos  
Spray huileux pour l'entretien des instruments  
Olio spray per preservare strumenti chirurgici

20

Verpackungseinheit 12 Stück  
Packing unit 12 pieces  
Caja con 12 piezas  
Boîte de 12 pièces  
Unità di 12 pezzi



**46.00.44**

Instrumentenpflegeöl, 125 ml Kunststoffflasche  
Instrument maintenance oil, 125 ml plastic-bottle  
Aceite para el mantenimiento de instrumentos, botella de plástico de 125 ml  
Huile pour l'entretien des instruments, bouteille en matière plastique 125 ml  
Olio per strumenti, bottiglia di plastica 125 ml





---

# 21

# medicon

**Nummerischer Index**  
**Numerical Index**  
**Indice numérico**  
**Index numérique**  
**Indice numérico**



**Numerischer Index**  
**Numerical Index**  
**Indice numérico**  
**Index numérique**  
**Indice numérico**

<b>02.20.11</b>	9	<b>04.33.70</b>	16	<b>05.16.74</b>	38
<b>02.20.61</b>	9	<b>04.33.73</b>	18	<b>05.16.75</b>	38
<b>02.21.11</b>	9	<b>04.33.76</b>	18	<b>05.18.20</b>	35
<b>02.21.61</b>	9	<b>04.33.80</b>	18	<b>05.18.21</b>	35
<b>02.40.12</b>	12	<b>04.34.14</b>	19	<b>05.18.25</b>	35
<b>02.40.62</b>	12	<b>04.34.18</b>	19	<b>05.18.26</b>	35
<b>02.41.12</b>	12	<b>04.34.20</b>	19	<b>05.18.68</b>	38
<b>02.41.62</b>	12	<b>04.34.23</b>	19	<b>05.18.69</b>	38
<b>02.50.12</b>	9	<b>04.34.64</b>	19	<b>05.18.70</b>	36
<b>02.50.13</b>	9	<b>04.34.68</b>	19	<b>05.18.71</b>	36
<b>02.50.52</b>	24	<b>04.34.70</b>	19	<b>05.18.72</b>	36
<b>02.51.52</b>	24	<b>04.34.73</b>	19	<b>05.18.73</b>	36
<b>03.02.84</b>	11	<b>04.35.14</b>	20	<b>05.18.74</b>	38
<b>03.03.84</b>	11	<b>04.35.18</b>	20	<b>05.18.75</b>	38
<b>03.04.84</b>	11	<b>04.35.20</b>	20	<b>05.18.81</b>	36
<b>03.05.84</b>	11	<b>04.35.23</b>	20	<b>05.18.83</b>	36
<b>03.06.84</b>	11	<b>04.35.64</b>	20	<b>05.18.90</b>	39
<b>03.07.84</b>	11	<b>04.35.68</b>	20	<b>05.18.92</b>	39
<b>04.10.61</b>	10	<b>04.35.70</b>	20	<b>05.18.93</b>	39
<b>04.11.61</b>	10	<b>04.35.73</b>	20	<b>05.18.94</b>	39
<b>04.13.12</b>	12	<b>04.54.16</b>	10	<b>05.18.95</b>	39
<b>04.13.13</b>	13	<b>04.54.66</b>	10	<b>05.18.96</b>	39
<b>04.13.15</b>	13	<b>04.55.16</b>	10	<b>05.18.97</b>	39
<b>04.13.18</b>	13	<b>04.55.66</b>	10	<b>05.18.98</b>	39
<b>04.13.20</b>	13	<b>04.65.18</b>	24	<b>05.18.99</b>	39
<b>04.13.63</b>	13	<b>04.65.23</b>	24	<b>05.19.01</b>	39
<b>04.13.65</b>	13	<b>04.67.12</b>	21	<b>05.19.02</b>	37
<b>04.13.68</b>	13	<b>04.67.14</b>	21	<b>05.19.10</b>	39
<b>04.24.14</b>	14	<b>04.67.16</b>	21	<b>05.19.25</b>	33
<b>04.24.64</b>	14	<b>04.67.18</b>	21	<b>05.19.45</b>	33
<b>04.25.14</b>	14	<b>04.70.18</b>	25	<b>05.19.60</b>	33
<b>04.25.64</b>	14	<b>04.70.19</b>	25	<b>05.19.90</b>	33
<b>04.32.11</b>	14	<b>04.71.18</b>	25	<b>05.19.95</b>	33
<b>04.32.14</b>	15	<b>04.71.19</b>	25	<b>05.21.25</b>	33
<b>04.32.18</b>	15	<b>04.73.67</b>	27	<b>05.21.45</b>	33
<b>04.32.20</b>	15	<b>04.73.69</b>	27	<b>05.21.60</b>	33
<b>04.32.23</b>	17	<b>04.73.73</b>	27	<b>05.21.68</b>	38
<b>04.32.26</b>	17	<b>04.75.67</b>	28	<b>05.21.69</b>	38
<b>04.32.30</b>	17	<b>04.75.69</b>	28	<b>05.21.74</b>	38
<b>04.32.61</b>	14	<b>04.75.73</b>	28	<b>05.21.75</b>	38
<b>04.32.64</b>	15	<b>04.83.16</b>	23	<b>05.21.90</b>	33
<b>04.32.68</b>	15	<b>05.12.32</b>	35	<b>05.21.95</b>	33
<b>04.32.70</b>	15	<b>05.12.34</b>	35	<b>06.00.64</b>	42
<b>04.32.73</b>	17	<b>05.15.70</b>	36	<b>06.00.68</b>	42
<b>04.33.11</b>	14	<b>05.15.71</b>	36	<b>06.00.70</b>	42
<b>04.33.14</b>	16	<b>05.15.72</b>	36	<b>06.00.75</b>	42
<b>04.33.15</b>	16	<b>05.15.73</b>	36	<b>06.02.65</b>	42
<b>04.33.18</b>	16	<b>05.15.74</b>	37	<b>06.02.68</b>	42
<b>04.33.20</b>	16	<b>05.15.75</b>	37	<b>06.02.70</b>	42
<b>04.33.23</b>	18	<b>05.15.76</b>	37	<b>06.02.73</b>	42
<b>04.33.26</b>	18	<b>05.15.77</b>	37	<b>06.02.75</b>	42
<b>04.33.30</b>	18	<b>05.15.81</b>	36	<b>06.04.33</b>	42
<b>04.33.61</b>	14	<b>05.15.83</b>	36	<b>06.04.34</b>	42
<b>04.33.64</b>	16	<b>05.16.68</b>	38	<b>06.04.36</b>	42
<b>04.33.68</b>	16	<b>05.16.69</b>	38	<b>06.20.65</b>	43

21



<b>06.21.65</b>	43	<b>06.55.30</b>	49	<b>06.91.15</b>	55
<b>06.22.15</b>	43	<b>06.56.15</b>	47	<b>06.91.18</b>	55
<b>06.23.15</b>	43	<b>06.56.24</b>	47	<b>06.91.21</b>	55
<b>06.25.12</b>	43	<b>06.57.15</b>	50	<b>06.92.15</b>	55
<b>06.25.15</b>	43	<b>06.57.19</b>	50	<b>06.92.18</b>	55
<b>06.25.72</b>	43	<b>06.57.24</b>	50	<b>06.92.21</b>	55
<b>06.25.82</b>	43	<b>06.57.30</b>	50	<b>06.93.15</b>	55
<b>06.31.12</b>	44	<b>06.58.15</b>	47	<b>06.93.18</b>	55
<b>06.31.15</b>	44	<b>06.58.24</b>	47	<b>06.93.21</b>	55
<b>06.31.22</b>	44	<b>06.59.15</b>	50	<b>07.10.15</b>	57
<b>06.31.25</b>	44	<b>06.59.19</b>	50	<b>07.10.20</b>	57
<b>06.31.32</b>	44	<b>06.59.24</b>	50	<b>07.10.25</b>	57
<b>06.34.51</b>	44	<b>06.59.30</b>	50	<b>07.15.93</b>	57
<b>06.34.53</b>	44	<b>06.60.17</b>	46	<b>07.16.15</b>	57
<b>06.34.55</b>	44	<b>06.60.68</b>	46	<b>07.16.23</b>	57
<b>06.34.58</b>	44	<b>06.60.69</b>	46	<b>07.16.65</b>	57
<b>06.34.60</b>	44	<b>06.60.87</b>	46	<b>07.16.73</b>	57
<b>06.35.51</b>	44	<b>06.62.15</b>	51	<b>07.16.74</b>	57
<b>06.35.53</b>	44	<b>06.62.19</b>	51	<b>07.17.18</b>	56
<b>06.35.55</b>	44	<b>06.62.24</b>	51	<b>07.17.23</b>	56
<b>06.35.58</b>	44	<b>06.62.30</b>	51	<b>07.19.15</b>	56
<b>06.35.60</b>	44	<b>06.64.15</b>	51	<b>07.19.23</b>	56
<b>06.40.15</b>	45	<b>06.64.19</b>	51	<b>07.60.08</b>	60
<b>06.40.85</b>	45	<b>06.64.24</b>	51	<b>07.63.30</b>	60
<b>06.45.20</b>	46	<b>06.64.30</b>	51	<b>07.63.31</b>	61
<b>06.45.90</b>	46	<b>06.66.15</b>	52	<b>07.63.32</b>	61
<b>06.46.18</b>	45	<b>06.66.19</b>	52	<b>07.64.63</b>	62
<b>06.46.20</b>	45	<b>06.66.24</b>	52	<b>07.64.64</b>	62
<b>06.46.25</b>	45	<b>06.66.30</b>	52	<b>07.64.73</b>	62
<b>06.47.18</b>	45	<b>06.70.15</b>	53	<b>07.64.74</b>	62
<b>06.47.20</b>	45	<b>06.70.20</b>	53	<b>07.64.83</b>	62
<b>06.48.18</b>	45	<b>06.70.24</b>	53	<b>07.64.84</b>	62
<b>06.48.20</b>	45	<b>06.72.15</b>	53	<b>07.64.93</b>	62
<b>06.48.25</b>	45	<b>06.72.20</b>	53	<b>07.64.94</b>	62
<b>06.49.18</b>	45	<b>06.72.24</b>	53	<b>07.66.13</b>	60
<b>06.49.20</b>	45	<b>06.74.15</b>	54	<b>07.66.15</b>	59
<b>06.50.15</b>	48	<b>06.74.20</b>	54	<b>07.70.11</b>	59
<b>06.50.19</b>	48	<b>06.74.24</b>	54	<b>07.70.15</b>	59
<b>06.50.24</b>	48	<b>06.76.15</b>	54	<b>07.70.18</b>	59
<b>06.50.30</b>	48	<b>06.76.20</b>	54	<b>07.72.19</b>	61
<b>06.51.15</b>	52	<b>06.76.24</b>	54	<b>07.72.40</b>	61
<b>06.51.20</b>	52	<b>06.88.07</b>	56	<b>07.73.15</b>	60
<b>06.51.24</b>	52	<b>06.88.10</b>	56	<b>07.73.18</b>	60
<b>06.51.30</b>	52	<b>06.88.14</b>	56	<b>07.73.21</b>	60
<b>06.52.15</b>	48	<b>06.88.18</b>	56	<b>07.73.25</b>	60
<b>06.52.19</b>	48	<b>06.88.27</b>	56	<b>07.73.28</b>	60
<b>06.52.24</b>	48	<b>06.89.15</b>	52	<b>07.73.31</b>	60
<b>06.52.30</b>	48	<b>06.89.18</b>	52	<b>07.74.15</b>	58
<b>06.54.15</b>	49	<b>06.89.21</b>	52	<b>07.74.18</b>	58
<b>06.54.19</b>	49	<b>06.89.25</b>	52	<b>07.74.21</b>	58
<b>06.54.24</b>	49	<b>06.89.28</b>	52	<b>07.75.15</b>	58
<b>06.54.30</b>	49	<b>06.89.31</b>	52	<b>07.75.18</b>	58
<b>06.55.15</b>	49	<b>06.90.15</b>	55	<b>07.75.21</b>	58
<b>06.55.19</b>	49	<b>06.90.18</b>	55	<b>07.75.30</b>	60
<b>06.55.24</b>	49	<b>06.90.21</b>	55	<b>07.75.31</b>	60



**Numerischer Index**  
**Numerical Index**  
**Indice numérico**  
**Index numérique**  
**Indice numèrico**

<b>07.75.32</b>	60	<b>09.96.12</b>	75	<b>10.29.65</b>	86
<b>07.76.15</b>	58	<b>09.96.14</b>	75	<b>10.29.66</b>	86
<b>07.76.18</b>	58	<b>09.96.19</b>	75	<b>10.29.68</b>	86
<b>07.76.21</b>	58	<b>09.96.53</b>	76	<b>10.29.69</b>	86
<b>07.77.15</b>	58	<b>09.96.54</b>	76	<b>10.29.70</b>	86
<b>07.77.18</b>	58	<b>09.96.55</b>	76	<b>10.29.71</b>	86
<b>07.77.21</b>	58	<b>09.96.56</b>	76	<b>10.29.73</b>	86
<b>09.85.00</b>	66	<b>09.96.71</b>	78	<b>10.29.74</b>	86
<b>09.85.01</b>	66	<b>09.96.72</b>	78	<b>10.30.64</b>	86
<b>09.85.05</b>	67	<b>09.96.73</b>	78	<b>10.30.65</b>	86
<b>09.85.07</b>	67	<b>09.96.75</b>	78	<b>10.30.68</b>	86
<b>09.85.08</b>	67	<b>09.96.77</b>	78	<b>10.30.69</b>	86
<b>09.85.12</b>	66	<b>10.12.63</b>	83	<b>10.30.70</b>	86
<b>09.85.15</b>	67	<b>10.14.64</b>	83	<b>10.30.71</b>	86
<b>09.85.17</b>	67	<b>10.18.65</b>	83	<b>10.30.73</b>	86
<b>09.86.10</b>	68	<b>10.18.68</b>	83	<b>10.30.74</b>	86
<b>09.86.15</b>	68	<b>10.18.70</b>	83	<b>10.31.71</b>	87
<b>09.86.16</b>	68	<b>10.18.73</b>	83	<b>10.35.70</b>	87
<b>09.86.20</b>	68	<b>10.18.74</b>	83	<b>10.35.74</b>	87
<b>09.86.25</b>	68	<b>10.18.76</b>	83	<b>10.37.70</b>	87
<b>09.86.27</b>	69	<b>10.18.80</b>	83	<b>10.37.74</b>	87
<b>09.86.28</b>	69	<b>10.18.85</b>	83	<b>10.37.76</b>	87
<b>09.86.29</b>	69	<b>10.18.88</b>	83	<b>10.37.80</b>	87
<b>09.95.00</b>	72	<b>10.18.90</b>	83	<b>10.39.17</b>	88
<b>09.95.11</b>	72	<b>10.18.93</b>	83	<b>10.39.64</b>	88
<b>09.95.12</b>	72	<b>10.20.64</b>	83	<b>10.39.65</b>	88
<b>09.95.16</b>	72	<b>10.20.65</b>	84	<b>10.39.66</b>	88
<b>09.95.18</b>	72	<b>10.20.68</b>	84	<b>10.39.67</b>	88
<b>09.95.26</b>	72	<b>10.20.70</b>	84	<b>10.40.77</b>	88
<b>09.95.29</b>	72	<b>10.20.73</b>	84	<b>10.40.78</b>	89
<b>09.95.32</b>	72	<b>10.20.75</b>	84	<b>10.43.77</b>	89
<b>09.95.35</b>	72	<b>10.20.80</b>	84	<b>11.20.64</b>	90
<b>09.95.39</b>	72, 73	<b>10.21.70</b>	84	<b>11.20.67</b>	90
<b>09.95.40</b>	73	<b>10.21.73</b>	84	<b>11.20.70</b>	90
<b>09.95.41</b>	73	<b>10.22.68</b>	84	<b>11.20.74</b>	90
<b>09.95.43</b>	73	<b>10.22.72</b>	84	<b>11.23.67</b>	90
<b>09.95.44</b>	73	<b>10.22.77</b>	84	<b>11.23.70</b>	90
<b>09.95.45</b>	73	<b>10.24.65</b>	85	<b>11.23.74</b>	90
<b>09.95.56</b>	74	<b>10.24.68</b>	85	<b>11.26.70</b>	90
<b>09.95.59</b>	74	<b>10.24.70</b>	85	<b>11.26.75</b>	90
<b>09.95.62</b>	74	<b>10.24.73</b>	85	<b>11.34.66</b>	90
<b>09.95.65</b>	74	<b>10.25.64</b>	85	<b>11.34.68</b>	90
<b>09.95.81</b>	74	<b>10.25.65</b>	85	<b>11.34.70</b>	90
<b>09.95.82</b>	74	<b>10.26.63</b>	85	<b>11.36.66</b>	90
<b>09.95.83</b>	74	<b>10.26.65</b>	85	<b>11.36.68</b>	90
<b>09.95.91</b>	73	<b>10.26.68</b>	85	<b>11.36.70</b>	90
<b>09.95.92</b>	73	<b>10.26.70</b>	85	<b>11.62.14</b>	91
<b>09.95.93</b>	73	<b>10.26.73</b>	85	<b>11.62.15</b>	91
<b>09.96.02</b>	75	<b>10.28.63</b>	85	<b>11.62.17</b>	91
<b>09.96.03</b>	75	<b>10.28.65</b>	85	<b>11.62.18</b>	91
<b>09.96.04</b>	75	<b>10.28.68</b>	85	<b>11.62.63</b>	91
<b>09.96.06</b>	75	<b>10.28.70</b>	85	<b>11.62.64</b>	91
<b>09.96.07</b>	75	<b>10.28.73</b>	85	<b>11.62.67</b>	91
<b>09.96.08</b>	75	<b>10.29.63</b>	86	<b>11.62.84</b>	91
<b>09.96.10</b>	75	<b>10.29.64</b>	86	<b>11.62.87</b>	91

21



<b>11.70.22</b>	91	<b>12.18.71</b>	96	<b>13.71.70</b>	64
<b>11.70.23</b>	91	<b>12.18.72</b>	96	<b>13.71.71</b>	64
<b>11.70.24</b>	91	<b>12.18.73</b>	96	<b>13.71.72</b>	64
<b>11.70.25</b>	91	<b>12.18.74</b>	96	<b>13.71.73</b>	64
<b>11.70.26</b>	91	<b>12.18.75</b>	96	<b>13.71.82</b>	63
<b>11.70.27</b>	91	<b>12.18.76</b>	93	<b>13.71.83</b>	63
<b>11.70.28</b>	91	<b>12.18.77</b>	93	<b>13.71.84</b>	64
<b>11.70.29</b>	91	<b>12.18.78</b>	93	<b>13.71.86</b>	64
<b>11.74.13</b>	92	<b>12.18.79</b>	93	<b>14.06.84</b>	40
<b>11.74.15</b>	92	<b>12.18.80</b>	93	<b>14.06.88</b>	40
<b>11.74.23</b>	92	<b>12.18.81</b>	93	<b>14.06.93</b>	40
<b>11.74.25</b>	92	<b>12.18.82</b>	93	<b>14.23.12</b>	100
<b>11.80.68</b>	92	<b>12.18.83</b>	93	<b>14.23.62</b>	100
<b>11.80.71</b>	92	<b>12.18.85</b>	94	<b>14.30.11</b>	100
<b>11.82.18</b>	92	<b>12.18.86</b>	94	<b>14.30.17</b>	100
<b>11.82.21</b>	92	<b>12.18.87</b>	94	<b>14.30.28</b>	100
<b>11.82.68</b>	92	<b>12.18.88</b>	94	<b>14.40.15</b>	102
<b>11.82.71</b>	92	<b>12.21.56</b>	93	<b>14.40.65</b>	102
<b>11.84.68</b>	92	<b>12.21.57</b>	93	<b>14.41.65</b>	102
<b>11.85.68</b>	92	<b>12.21.60</b>	93	<b>14.44.17</b>	102
<b>11.86.68</b>	92	<b>12.21.61</b>	93	<b>14.44.67</b>	102
<b>11.87.68</b>	92	<b>12.21.66</b>	93	<b>14.46.14</b>	103
<b>12.12.54</b>	93	<b>12.21.67</b>	93	<b>14.46.15</b>	103
<b>12.12.55</b>	93	<b>12.21.70</b>	93	<b>14.48.01</b>	104
<b>12.12.56</b>	93	<b>12.21.71</b>	93	<b>14.48.03</b>	104
<b>12.12.57</b>	93	<b>12.21.76</b>	93	<b>14.48.04</b>	103
<b>12.12.59</b>	93	<b>12.21.77</b>	93	<b>14.48.05</b>	103
<b>12.12.61</b>	93	<b>12.21.78</b>	93	<b>14.48.07</b>	103
<b>12.15.30</b>	95	<b>12.21.79</b>	93	<b>15.04.30</b>	120
<b>12.15.31</b>	95	<b>12.21.80</b>	93	<b>15.04.31</b>	120
<b>12.15.32</b>	95	<b>12.21.81</b>	93	<b>15.04.35</b>	121
<b>12.15.33</b>	95	<b>12.21.82</b>	93	<b>15.04.36</b>	121
<b>12.15.50</b>	95	<b>12.21.83</b>	93	<b>15.04.40</b>	121
<b>12.15.51</b>	95	<b>12.21.95</b>	94	<b>15.04.41</b>	121
<b>12.15.56</b>	93	<b>12.21.96</b>	94	<b>15.04.50</b>	121
<b>12.15.57</b>	93	<b>12.21.97</b>	94	<b>15.04.51</b>	121
<b>12.15.66</b>	93	<b>12.21.98</b>	94	<b>15.05.30</b>	120
<b>12.15.67</b>	93	<b>13.70.72</b>	61	<b>15.05.31</b>	120
<b>12.15.70</b>	96	<b>13.70.74</b>	61	<b>15.05.35</b>	121
<b>12.15.71</b>	96	<b>13.71.05</b>	64	<b>15.05.36</b>	121
<b>12.15.72</b>	96	<b>13.71.08</b>	64	<b>15.05.40</b>	121
<b>12.15.73</b>	96	<b>13.71.11</b>	64	<b>15.05.41</b>	121
<b>12.15.76</b>	93	<b>13.71.15</b>	64	<b>15.05.50</b>	121
<b>12.15.77</b>	93	<b>13.71.18</b>	64	<b>15.05.51</b>	121
<b>12.15.78</b>	93	<b>13.71.21</b>	64	<b>15.07.30</b>	120
<b>12.15.79</b>	93	<b>13.71.42</b>	63	<b>15.07.31</b>	120
<b>12.16.75</b>	94	<b>13.71.43</b>	63	<b>15.07.35</b>	121
<b>12.16.76</b>	94	<b>13.71.50</b>	64	<b>15.07.36</b>	121
<b>12.16.77</b>	94	<b>13.71.51</b>	64	<b>15.07.40</b>	121
<b>12.16.78</b>	94	<b>13.71.52</b>	64	<b>15.07.41</b>	121
<b>12.18.56</b>	93	<b>13.71.53</b>	64	<b>15.07.50</b>	121
<b>12.18.57</b>	93	<b>13.71.60</b>	64	<b>15.07.51</b>	121
<b>12.18.66</b>	93	<b>13.71.61</b>	64	<b>15.10.08</b>	122
<b>12.18.67</b>	93	<b>13.71.62</b>	64	<b>15.10.12</b>	122
<b>12.18.70</b>	96	<b>13.71.63</b>	64	<b>15.10.16</b>	122



**Numerischer Index**  
**Numerical Index**  
**Indice numérico**  
**Index numérique**  
**Indice numérico**

<b>15.10.38</b>	123	<b>15.44.10</b>	129	<b>16.11.26</b>	134
<b>15.10.51</b>	123	<b>15.44.12</b>	130	<b>16.11.44</b>	135
<b>15.11.08</b>	122	<b>15.44.14</b>	130	<b>16.11.50</b>	135
<b>15.11.12</b>	122	<b>15.44.22</b>	129	<b>16.11.56</b>	135
<b>15.11.16</b>	122	<b>15.44.32</b>	130	<b>16.11.58</b>	135
<b>15.11.38</b>	123	<b>15.44.42</b>	129	<b>16.12.13</b>	133
<b>15.11.51</b>	123	<b>15.44.82</b>	130	<b>16.12.14</b>	133
<b>15.12.35</b>	123	<b>15.45.10</b>	129	<b>16.12.16</b>	136
<b>15.12.55</b>	123	<b>15.45.12</b>	130	<b>16.12.18</b>	136
<b>15.13.35</b>	123	<b>15.45.14</b>	130	<b>16.12.20</b>	136
<b>15.13.55</b>	123	<b>15.45.22</b>	129	<b>16.12.22</b>	136
<b>15.15.38</b>	124	<b>15.45.32</b>	130	<b>16.12.24</b>	136
<b>15.15.51</b>	124	<b>15.45.42</b>	129	<b>16.12.26</b>	136
<b>15.15.57</b>	124	<b>15.45.82</b>	130	<b>16.12.85</b>	133
<b>15.15.63</b>	124	<b>15.46.12</b>	130	<b>16.12.96</b>	133
<b>15.15.70</b>	124	<b>15.46.32</b>	130	<b>16.13.13</b>	133
<b>15.15.76</b>	124	<b>15.47.12</b>	130	<b>16.13.14</b>	133
<b>15.15.89</b>	124	<b>15.47.32</b>	130	<b>16.13.16</b>	136
<b>15.15.91</b>	127	<b>15.56.15</b>	131	<b>16.13.18</b>	136
<b>15.15.92</b>	127	<b>15.57.15</b>	131	<b>16.13.20</b>	136
<b>15.15.94</b>	127	<b>15.58.15</b>	131	<b>16.13.22</b>	136
<b>15.15.95</b>	127	<b>15.59.15</b>	131	<b>16.13.24</b>	136
<b>15.16.07</b>	125	<b>15.72.14</b>	131	<b>16.13.26</b>	136
<b>15.16.08</b>	125	<b>15.72.34</b>	131	<b>16.14.74</b>	137
<b>15.16.10</b>	125	<b>15.72.64</b>	131	<b>16.15.74</b>	137
<b>15.16.12</b>	125	<b>15.72.74</b>	131	<b>16.15.92</b>	137
<b>15.17.07</b>	125	<b>15.73.14</b>	131	<b>16.15.93</b>	137
<b>15.17.08</b>	125	<b>15.73.34</b>	131	<b>16.15.94</b>	137
<b>15.17.10</b>	125	<b>15.73.64</b>	131	<b>16.40.18</b>	138
<b>15.17.12</b>	125	<b>15.73.74</b>	131	<b>16.40.19</b>	138
<b>15.18.07</b>	126	<b>15.84.16</b>	132	<b>16.40.21</b>	138
<b>15.18.08</b>	126	<b>15.84.20</b>	132	<b>16.40.88</b>	138
<b>15.18.09</b>	126	<b>15.85.16</b>	132	<b>16.41.18</b>	138
<b>15.18.11</b>	126	<b>15.85.18</b>	132	<b>16.41.19</b>	138
<b>15.19.07</b>	126	<b>15.85.66</b>	132	<b>16.41.21</b>	138
<b>15.19.08</b>	126	<b>15.85.68</b>	132	<b>16.41.88</b>	138
<b>15.19.09</b>	126	<b>16.10.13</b>	133	<b>16.41.89</b>	138
<b>15.19.11</b>	126	<b>16.10.14</b>	133	<b>16.50.20</b>	139
<b>15.19.55</b>	126	<b>16.10.16</b>	134	<b>16.50.24</b>	139
<b>15.19.58</b>	126	<b>16.10.18</b>	134	<b>16.50.28</b>	140
<b>15.19.59</b>	126	<b>16.10.20</b>	134	<b>16.51.20</b>	139
<b>15.19.60</b>	126	<b>16.10.22</b>	134	<b>16.51.21</b>	139
<b>15.19.93</b>	125	<b>16.10.24</b>	134	<b>16.51.24</b>	139
<b>15.20.14</b>	128	<b>16.10.26</b>	134	<b>16.51.25</b>	139
<b>15.21.14</b>	128	<b>16.10.44</b>	135	<b>16.51.28</b>	140
<b>15.24.14</b>	128	<b>16.10.50</b>	135	<b>16.51.90</b>	139
<b>15.25.14</b>	128	<b>16.10.56</b>	135	<b>16.51.94</b>	139
<b>15.28.14</b>	128	<b>16.10.58</b>	135	<b>16.51.97</b>	140
<b>15.29.14</b>	128	<b>16.11.13</b>	133	<b>16.52.20</b>	142
<b>15.40.12</b>	128	<b>16.11.14</b>	133	<b>16.53.20</b>	142
<b>15.40.84</b>	129	<b>16.11.16</b>	134	<b>16.56.20</b>	141
<b>15.41.12</b>	128	<b>16.11.18</b>	134	<b>16.56.23</b>	141
<b>15.41.84</b>	129	<b>16.11.20</b>	134	<b>16.57.20</b>	141
<b>15.42.12</b>	128	<b>16.11.22</b>	134	<b>16.57.23</b>	141
<b>15.43.12</b>	128	<b>16.11.24</b>	134	<b>16.57.26</b>	141



<b>16.58.20</b>	141	<b>17.36.65</b>	200	<b>23.25.02</b>	216
<b>16.58.23</b>	141	<b>17.36.70</b>	200	<b>23.25.03</b>	216
<b>16.59.20</b>	141	<b>17.36.82</b>	201	<b>23.25.04</b>	216
<b>16.59.23</b>	141	<b>20.15.13</b>	209	<b>23.25.05</b>	216
<b>16.59.26</b>	141	<b>20.15.16</b>	209	<b>23.25.06</b>	216
<b>16.61.19</b>	142	<b>20.17.08</b>	209	<b>23.25.07</b>	216
<b>16.64.18</b>	144	<b>20.17.10</b>	209	<b>23.25.08</b>	216
<b>16.64.20</b>	144	<b>20.17.12</b>	209	<b>23.25.09</b>	216
<b>16.64.21</b>	144	<b>20.17.14</b>	209	<b>23.25.10</b>	216
<b>16.64.22</b>	144	<b>20.17.16</b>	209	<b>23.25.11</b>	216
<b>16.65.19</b>	143	<b>20.17.18</b>	209	<b>23.25.12</b>	216
<b>16.65.21</b>	143	<b>20.17.28</b>	209	<b>23.25.13</b>	216
<b>16.65.22</b>	143	<b>20.17.30</b>	209	<b>23.25.14</b>	216
<b>16.65.27</b>	143	<b>20.17.32</b>	209	<b>23.29.35</b>	217
<b>16.65.28</b>	143	<b>20.17.34</b>	209	<b>23.29.60</b>	217
<b>16.65.70</b>	143	<b>20.17.36</b>	209	<b>23.29.75</b>	217
<b>16.65.71</b>	143	<b>20.17.38</b>	209	<b>23.29.80</b>	217
<b>16.65.72</b>	143	<b>20.17.50</b>	212	<b>23.60.50</b>	217
<b>16.65.73</b>	143	<b>20.17.90</b>	213	<b>23.61.01</b>	218
<b>16.65.76</b>	143	<b>20.18.10</b>	212	<b>23.61.02</b>	218
<b>16.65.77</b>	143	<b>20.18.15</b>	212	<b>23.61.03</b>	218
<b>16.65.78</b>	143	<b>20.18.20</b>	212	<b>23.69.05</b>	219
<b>16.66.23</b>	144	<b>20.18.30</b>	212	<b>23.69.08</b>	220
<b>16.66.24</b>	144	<b>20.18.40</b>	212	<b>23.69.12</b>	220
<b>17.05.14</b>	145	<b>20.20.12</b>	206	<b>23.69.15</b>	220
<b>17.05.19</b>	145	<b>20.20.17</b>	206	<b>23.69.51</b>	219
<b>17.06.14</b>	145	<b>20.20.18</b>	206	<b>23.70.24</b>	221
<b>17.06.19</b>	145	<b>20.20.34</b>	206	<b>23.70.40</b>	221
<b>17.06.89</b>	145	<b>20.20.57</b>	206	<b>23.70.62</b>	221
<b>17.07.18</b>	145	<b>20.20.59</b>	206	<b>23.71.06</b>	222
<b>17.07.23</b>	145	<b>20.22.01</b>	206	<b>23.72.17</b>	222
<b>17.07.50</b>	146	<b>20.22.02</b>	206	<b>23.72.25</b>	222
<b>17.07.60</b>	146	<b>20.22.03</b>	206	<b>23.73.25</b>	223
<b>17.07.70</b>	146	<b>20.22.31</b>	206	<b>23.73.35</b>	223
<b>17.07.75</b>	148	<b>20.22.32</b>	206	<b>23.73.50</b>	223
<b>17.07.77</b>	148	<b>20.22.36</b>	206	<b>23.73.75</b>	223
<b>17.08.14</b>	147	<b>20.22.37</b>	206	<b>23.75.01</b>	224
<b>17.08.18</b>	147	<b>20.22.38</b>	206	<b>23.75.02</b>	224
<b>17.08.20</b>	147	<b>20.30.19</b>	207	<b>23.75.03</b>	224
<b>17.08.23</b>	147	<b>20.30.20</b>	207	<b>23.75.04</b>	224
<b>17.08.27</b>	147	<b>23.03.06</b>	213	<b>23.75.05</b>	225
<b>17.10.19</b>	148	<b>23.05.10</b>	213	<b>23.75.06</b>	225
<b>17.11.19</b>	148	<b>23.05.14</b>	213	<b>23.75.07</b>	225
<b>17.11.23</b>	148	<b>23.05.16</b>	213	<b>23.75.08</b>	225
<b>17.12.19</b>	149	<b>23.06.10</b>	214	<b>23.75.09</b>	226
<b>17.12.22</b>	149	<b>23.06.12</b>	214	<b>23.75.10</b>	226
<b>17.12.25</b>	149	<b>23.06.13</b>	214	<b>23.80.03</b>	227
<b>17.12.27</b>	149	<b>23.06.16</b>	214	<b>23.80.04</b>	227
<b>17.12.29</b>	149	<b>23.07.10</b>	214	<b>24.03.07</b>	236
<b>17.32.75</b>	201	<b>23.07.13</b>	214	<b>24.09.09</b>	236
<b>17.32.77</b>	201	<b>23.07.16</b>	214	<b>24.09.10</b>	236
<b>17.36.05</b>	200	<b>23.08.55</b>	215	<b>24.10.07</b>	236
<b>17.36.45</b>	200	<b>23.08.63</b>	215	<b>24.10.08</b>	236
<b>17.36.46</b>	200	<b>23.08.85</b>	215	<b>24.10.10</b>	236
<b>17.36.50</b>	200	<b>23.25.01</b>	216	<b>24.10.11</b>	236



**Numerischer Index**  
**Numerical Index**  
**Indice numérico**  
**Index numérique**  
**Indice numérico**

<b>24.22.13</b>	236	<b>31.61.03</b>	251	<b>51.57.98</b>	211
<b>24.22.14</b>	236	<b>31.61.04</b>	251	<b>54.10.19</b>	259
<b>24.22.15</b>	236	<b>31.61.36</b>	251	<b>54.10.22</b>	259
<b>24.22.16</b>	236	<b>33.02.15</b>	253	<b>54.12.34</b>	259
<b>24.22.17</b>	236	<b>33.20.14</b>	252	<b>54.12.51</b>	258
<b>24.22.18</b>	236	<b>33.20.17</b>	252	<b>54.12.52</b>	258
<b>24.22.20</b>	237	<b>33.20.19</b>	252	<b>54.15.01</b>	261
<b>24.22.21</b>	237	<b>33.20.22</b>	252	<b>54.15.02</b>	261
<b>24.22.24</b>	237	<b>33.21.14</b>	252	<b>54.15.25</b>	260
<b>24.22.25</b>	237	<b>33.21.17</b>	252	<b>54.17.26</b>	260
<b>24.22.26</b>	237	<b>33.21.19</b>	252	<b>54.18.50</b>	268
<b>24.22.27</b>	237	<b>33.21.22</b>	252	<b>54.18.52</b>	268
<b>24.30.13</b>	238	<b>33.56.18</b>	253	<b>54.18.55</b>	268
<b>24.30.14</b>	238	<b>33.57.18</b>	253	<b>54.18.57</b>	268
<b>24.30.16</b>	238	<b>33.58.18</b>	253	<b>54.18.60</b>	269
<b>24.30.17</b>	238	<b>33.59.17</b>	253	<b>54.18.62</b>	269
<b>24.30.20</b>	238	<b>33.59.18</b>	253	<b>54.18.65</b>	269
<b>24.30.21</b>	238	<b>33.70.27</b>	254	<b>54.18.67</b>	269
<b>24.32.04</b>	238	<b>33.71.27</b>	254	<b>54.18.70</b>	270
<b>24.32.06</b>	239	<b>33.75.27</b>	254	<b>54.18.72</b>	270
<b>24.34.25</b>	239	<b>35.15.18</b>	256	<b>54.18.90</b>	296
<b>24.34.26</b>	239	<b>35.15.19</b>	256	<b>54.22.20</b>	281
<b>24.34.45</b>	239	<b>35.20.20</b>	256	<b>54.22.21</b>	281
<b>24.34.46</b>	239	<b>35.24.20</b>	257	<b>54.22.41</b>	288
<b>24.34.50</b>	239	<b>35.25.20</b>	257	<b>54.22.42</b>	288
<b>26.54.10</b>	242	<b>35.50.21</b>	257	<b>54.22.50</b>	281
<b>26.54.15</b>	242	<b>35.52.21</b>	257	<b>54.22.60</b>	280
<b>26.54.20</b>	242	<b>46.00.40</b>	321	<b>54.22.61</b>	279
<b>26.54.25</b>	242	<b>46.00.44</b>	321	<b>54.22.63</b>	279
<b>26.60.35</b>	242	<b>49.90.00</b>	320	<b>54.22.64</b>	280
<b>26.62.01</b>	242	<b>49.90.02</b>	320	<b>54.22.65</b>	279
<b>26.62.02</b>	242	<b>50.03.15</b>	202	<b>54.22.67</b>	279
<b>26.76.01</b>	243	<b>50.03.16</b>	202	<b>54.23.01</b>	285
<b>26.76.02</b>	243	<b>50.03.19</b>	202	<b>54.23.02</b>	285
<b>26.76.03</b>	243	<b>50.03.20</b>	202	<b>54.23.03</b>	285
<b>26.76.04</b>	243	<b>50.03.25</b>	202	<b>54.23.05</b>	282
<b>26.76.07</b>	243	<b>50.03.27</b>	202	<b>54.23.11</b>	285
<b>31.09.03</b>	248	<b>50.08.16</b>	202	<b>54.23.12</b>	285
<b>31.09.13</b>	248	<b>50.10.15</b>	203	<b>54.23.13</b>	285
<b>31.09.23</b>	248	<b>50.10.16</b>	203	<b>54.23.21</b>	284
<b>31.30.23</b>	248	<b>50.10.20</b>	203	<b>54.23.42</b>	272
<b>31.30.24</b>	248	<b>50.10.23</b>	203	<b>54.23.43</b>	272
<b>31.30.27</b>	248	<b>50.10.66</b>	203	<b>54.23.44</b>	272
<b>31.31.23</b>	248	<b>50.10.70</b>	203	<b>54.23.48</b>	273
<b>31.31.24</b>	248	<b>50.11.16</b>	204	<b>54.23.50</b>	273
<b>31.31.27</b>	248	<b>50.11.20</b>	204	<b>54.23.53</b>	271
<b>31.31.53</b>	249	<b>50.11.23</b>	204	<b>54.23.54</b>	271
<b>31.31.57</b>	249	<b>51.57.08</b>	210	<b>54.23.55</b>	271
<b>31.31.83</b>	249	<b>51.57.11</b>	210	<b>54.23.57</b>	283
<b>31.51.05</b>	250	<b>51.57.15</b>	210	<b>54.23.58</b>	283
<b>31.51.08</b>	250	<b>51.57.17</b>	210	<b>54.23.59</b>	283
<b>31.53.03</b>	250	<b>51.57.89</b>	211	<b>54.23.60</b>	291
<b>31.53.05</b>	250	<b>51.57.91</b>	211	<b>54.23.61</b>	291
<b>31.53.08</b>	250	<b>51.57.93</b>	211	<b>54.23.62</b>	286
<b>31.61.02</b>	251	<b>51.57.95</b>	211	<b>54.23.63</b>	292

21





<b>54.23.64</b>	286	<b>54.59.44</b>	153	<b>55.11.30</b>	234
<b>54.23.65</b>	291	<b>54.59.56</b>	154	<b>55.11.31</b>	234
<b>54.23.67</b>	289	<b>54.59.66</b>	154	<b>55.11.32</b>	234
<b>54.23.69</b>	289	<b>55.08.07</b>	305	<b>55.11.34</b>	229
<b>54.23.70</b>	274	<b>55.08.08</b>	305	<b>55.11.36</b>	229
<b>54.23.72</b>	274	<b>55.08.09</b>	305	<b>55.13.11</b>	25
<b>54.23.73</b>	290	<b>55.08.14</b>	304	<b>55.13.13</b>	25
<b>54.23.74</b>	275	<b>55.08.15</b>	304	<b>55.13.15</b>	25
<b>54.23.76</b>	276	<b>55.08.16</b>	304	<b>55.13.18</b>	26
<b>54.23.78</b>	277	<b>55.08.21</b>	304	<b>55.13.19</b>	26
<b>54.23.80</b>	278	<b>55.08.30</b>	304	<b>55.13.50</b>	26
<b>54.23.82</b>	286	<b>55.08.50</b>	299	<b>55.13.75</b>	26
<b>54.23.86</b>	286	<b>55.08.55</b>	299	<b>55.15.02</b>	29
<b>54.23.90</b>	287	<b>55.08.70</b>	299	<b>55.15.04</b>	29
<b>54.23.92</b>	293	<b>55.08.80</b>	302	<b>55.15.06</b>	29
<b>54.23.94</b>	294	<b>55.08.81</b>	303	<b>55.15.12</b>	29
<b>54.23.96</b>	294	<b>55.08.82</b>	303	<b>55.15.14</b>	29
<b>54.23.98</b>	294	<b>55.08.83</b>	303	<b>55.15.15</b>	29
<b>54.23.99</b>	295	<b>55.08.84</b>	303	<b>55.15.16</b>	29
<b>54.25.10</b>	264	<b>55.08.85</b>	303	<b>55.15.22</b>	29
<b>54.25.20</b>	264	<b>55.08.86</b>	303	<b>55.15.24</b>	29
<b>54.25.40</b>	264	<b>55.08.87</b>	303	<b>55.15.26</b>	29
<b>54.25.50</b>	264	<b>55.08.88</b>	303	<b>55.15.32</b>	31
<b>54.30.01</b>	245	<b>55.08.90</b>	303	<b>55.15.34</b>	31
<b>54.30.02</b>	245	<b>55.08.92</b>	303	<b>55.15.36</b>	31
<b>54.30.11</b>	245	<b>55.08.93</b>	303	<b>55.15.39</b>	31
<b>54.30.12</b>	245	<b>55.08.94</b>	303	<b>55.15.40</b>	31
<b>54.30.21</b>	245	<b>55.08.95</b>	303	<b>55.15.41</b>	31
<b>54.30.22</b>	245	<b>55.08.97</b>	303	<b>55.15.42</b>	30
<b>54.30.55</b>	246	<b>55.09.90</b>	298	<b>55.15.44</b>	30
<b>54.30.56</b>	246	<b>55.09.93</b>	298	<b>55.15.46</b>	30
<b>54.31.30</b>	244	<b>55.09.95</b>	298	<b>55.15.50</b>	30
<b>54.31.35</b>	244	<b>55.10.00</b>	298	<b>55.15.51</b>	30
<b>54.35.05</b>	228	<b>55.10.05</b>	298	<b>55.15.55</b>	32
<b>54.35.10</b>	228	<b>55.10.10</b>	298	<b>55.15.58</b>	32
<b>54.35.15</b>	228	<b>55.10.15</b>	298	<b>55.15.59</b>	32
<b>54.35.20</b>	229	<b>55.10.20</b>	298	<b>55.15.60</b>	32
<b>54.35.24</b>	229	<b>55.10.25</b>	298	<b>55.15.63</b>	32
<b>54.35.50</b>	229	<b>55.10.30</b>	298	<b>55.22.11</b>	159
<b>54.35.90</b>	229	<b>55.10.35</b>	298	<b>55.22.15</b>	186
<b>54.40.27</b>	22	<b>55.10.40</b>	298	<b>55.22.27</b>	186
<b>54.40.30</b>	22	<b>55.10.45</b>	298	<b>55.22.28</b>	186
<b>54.41.27</b>	23	<b>55.10.50</b>	298	<b>55.22.81</b>	187
<b>54.55.23</b>	150	<b>55.10.70</b>	298	<b>55.22.82</b>	187
<b>54.55.24</b>	150	<b>55.10.90</b>	298	<b>55.25.01</b>	172
<b>54.55.74</b>	150	<b>55.11.10</b>	230	<b>55.25.03</b>	170
<b>54.57.05</b>	151	<b>55.11.11</b>	231	<b>55.25.04</b>	160
<b>54.57.11</b>	151	<b>55.11.12</b>	232	<b>55.25.05</b>	175
<b>54.57.12</b>	151	<b>55.11.13</b>	232	<b>55.25.06</b>	175
<b>54.57.51</b>	152	<b>55.11.14</b>	233	<b>55.25.11</b>	172
<b>54.57.52</b>	152	<b>55.11.15</b>	233	<b>55.25.13</b>	170
<b>54.58.60</b>	152	<b>55.11.16</b>	233	<b>55.30.04</b>	155
<b>54.58.80</b>	152	<b>55.11.27</b>	234	<b>55.30.14</b>	155
<b>54.59.14</b>	153	<b>55.11.28</b>	234	<b>55.30.15</b>	155
<b>54.59.34</b>	153	<b>55.11.29</b>	234	<b>55.30.24</b>	155



**Numerischer Index**  
**Numerical Index**  
**Indice numérico**  
**Index numérique**  
**Indice numérico**

<b>55.30.34</b>	155	<b>55.35.58</b>	167	<b>55.59.27</b>	181
<b>55.30.44</b>	155	<b>55.36.33</b>	156	<b>55.60.07</b>	183
<b>55.33.04</b>	192	<b>55.36.63</b>	156	<b>55.60.08</b>	183
<b>55.33.10</b>	192	<b>55.36.93</b>	156	<b>55.60.10</b>	183
<b>55.33.12</b>	192	<b>55.37.33</b>	156	<b>55.60.12</b>	183
<b>55.33.21</b>	193	<b>55.37.63</b>	156	<b>55.60.40</b>	183
<b>55.33.22</b>	193	<b>55.37.73</b>	192	<b>55.63.22</b>	169
<b>55.33.23</b>	193	<b>55.37.83</b>	157	<b>55.63.25</b>	169
<b>55.33.24</b>	193	<b>55.37.93</b>	156	<b>55.64.35</b>	184
<b>55.33.25</b>	193	<b>55.37.94</b>	157	<b>55.64.36</b>	184
<b>55.33.26</b>	193	<b>55.37.95</b>	157	<b>55.64.37</b>	184
<b>55.33.27</b>	193	<b>55.37.96</b>	157	<b>55.64.46</b>	189
<b>55.33.28</b>	193	<b>55.37.98</b>	157	<b>55.64.55</b>	185
<b>55.33.29</b>	193	<b>55.38.15</b>	174	<b>55.64.65</b>	185
<b>55.33.34</b>	192	<b>55.38.20</b>	174	<b>55.64.76</b>	185
<b>55.33.40</b>	194	<b>55.38.25</b>	174	<b>55.64.77</b>	185
<b>55.33.41</b>	194	<b>55.39.15</b>	174	<b>55.64.81</b>	190
<b>55.33.42</b>	194	<b>55.39.18</b>	193	<b>55.64.82</b>	190
<b>55.33.43</b>	194	<b>55.39.19</b>	174	<b>55.64.94</b>	191
<b>55.33.45</b>	194	<b>55.39.20</b>	193	<b>55.70.35</b>	168
<b>55.33.47</b>	195	<b>55.39.24</b>	174	<b>55.70.45</b>	168
<b>55.33.48</b>	195	<b>55.39.25</b>	193	<b>55.70.55</b>	168
<b>55.33.49</b>	195	<b>55.39.29</b>	193	<b>55.70.60</b>	168
<b>55.33.54</b>	192	<b>55.39.75</b>	175	<b>55.70.75</b>	168
<b>55.33.57</b>	196	<b>55.39.81</b>	158	<b>55.74.32</b>	187
<b>55.33.58</b>	196	<b>55.39.83</b>	158	<b>55.74.40</b>	187
<b>55.33.59</b>	196	<b>55.39.91</b>	158	<b>55.74.50</b>	187
<b>55.33.60</b>	196	<b>55.39.93</b>	158	<b>55.74.52</b>	188
<b>55.33.62</b>	196	<b>55.40.03</b>	171	<b>55.74.53</b>	188
<b>55.33.63</b>	196	<b>55.40.05</b>	173	<b>55.74.55</b>	188
<b>55.33.64</b>	196	<b>55.40.13</b>	171	<b>55.74.56</b>	188
<b>55.33.65</b>	196	<b>55.40.15</b>	173	<b>55.74.57</b>	188
<b>55.33.94</b>	192	<b>55.44.35</b>	160	<b>55.74.58</b>	188
<b>55.34.03</b>	171	<b>55.44.39</b>	176	<b>55.74.93</b>	169
<b>55.34.05</b>	173	<b>55.50.07</b>	177	<b>55.80.40</b>	162
<b>55.34.13</b>	171	<b>55.50.16</b>	177	<b>55.80.50</b>	162
<b>55.34.15</b>	173	<b>55.50.21</b>	177	<b>55.80.65</b>	162
<b>55.34.35</b>	159	<b>55.50.24</b>	177	<b>55.80.75</b>	162
<b>55.34.39</b>	176	<b>55.52.34</b>	178	<b>55.80.99</b>	162
<b>55.34.46</b>	184	<b>55.52.47</b>	178	<b>55.82.40</b>	163
<b>55.34.47</b>	184	<b>55.52.48</b>	178	<b>55.82.50</b>	163
<b>55.35.03</b>	170	<b>55.52.51</b>	179	<b>55.82.65</b>	163
<b>55.35.05</b>	172	<b>55.52.53</b>	179	<b>55.82.99</b>	163
<b>55.35.13</b>	170	<b>55.52.54</b>	179	<b>55.83.21</b>	164
<b>55.35.15</b>	172	<b>55.52.55</b>	179	<b>55.83.22</b>	164
<b>55.35.35</b>	159	<b>55.52.59</b>	180	<b>55.83.26</b>	164
<b>55.35.39</b>	175	<b>55.52.60</b>	180	<b>55.83.27</b>	164
<b>55.35.46</b>	159	<b>55.58.18</b>	181	<b>55.83.31</b>	165
<b>55.35.47</b>	159	<b>55.58.19</b>	181	<b>55.83.33</b>	165
<b>55.35.49</b>	166	<b>55.58.27</b>	181	<b>55.83.35</b>	165
<b>55.35.50</b>	166	<b>55.58.40</b>	182	<b>55.83.39</b>	165
<b>55.35.52</b>	166	<b>55.58.50</b>	182	<b>55.84.65</b>	189
<b>55.35.53</b>	166	<b>55.58.60</b>	182	<b>55.84.70</b>	189
<b>55.35.54</b>	167	<b>55.59.18</b>	181	<b>55.85.00</b>	161
<b>55.35.57</b>	167	<b>55.59.19</b>	181	<b>55.85.15</b>	161

21



<b>55.85.30</b>	161	<b>56.82.20</b>	116	<b>56.87.05</b>	111
<b>55.85.45</b>	161	<b>56.82.21</b>	116	<b>56.87.08</b>	111
<b>55.85.90</b>	161	<b>56.82.22</b>	116	<b>56.87.18</b>	111
<b>55.86.00</b>	161	<b>56.82.23</b>	116	<b>56.87.30</b>	111
<b>55.86.15</b>	161	<b>56.82.24</b>	116	<b>56.87.35</b>	111
<b>55.86.30</b>	161	<b>56.82.25</b>	116	<b>56.87.38</b>	112
<b>55.86.45</b>	161	<b>56.85.07</b>	107	<b>56.87.45</b>	111, 113, 114
<b>55.86.90</b>	161	<b>56.85.08</b>	107	<b>56.87.46</b>	111, 113, 114
<b>55.86.91</b>	197	<b>56.85.10</b>	107	<b>56.87.49</b>	112
<b>55.86.92</b>	197	<b>56.85.11</b>	107	<b>57.25.20</b>	27
<b>55.86.93</b>	197	<b>56.85.13</b>	107	<b>57.35.19</b>	78
<b>55.86.94</b>	197	<b>56.85.14</b>	107	<b>57.35.20</b>	78
<b>55.86.95</b>	197	<b>56.85.16</b>	107	<b>57.36.14</b>	79
<b>55.86.96</b>	197	<b>56.85.17</b>	107	<b>57.36.25</b>	79
<b>55.86.97</b>	197	<b>56.85.18</b>	107	<b>57.36.26</b>	79
<b>55.90.05</b>	265	<b>56.85.19</b>	107	<b>57.49.10</b>	208
<b>55.90.06</b>	265	<b>56.85.27</b>	108	<b>58.16.45</b>	97
<b>55.90.07</b>	265	<b>56.85.28</b>	108	<b>58.16.48</b>	97
<b>55.90.50</b>	266	<b>56.85.30</b>	108	<b>58.19.20</b>	34
<b>55.90.55</b>	267	<b>56.85.31</b>	108	<b>58.19.21</b>	34
<b>55.90.60</b>	267	<b>56.85.33</b>	108	<b>58.19.25</b>	34
<b>56.50.01</b>	106	<b>56.85.34</b>	108	<b>58.19.26</b>	34
<b>56.50.02</b>	106	<b>56.85.36</b>	108	<b>58.19.27</b>	34
<b>56.50.03</b>	106	<b>56.85.37</b>	108	<b>58.19.28</b>	34
<b>56.50.04</b>	106	<b>56.85.47</b>	108	<b>58.19.29</b>	34
<b>56.50.11</b>	106	<b>56.85.48</b>	108	<b>58.19.30</b>	34
<b>56.50.12</b>	106	<b>56.85.50</b>	108	<b>58.19.31</b>	34
<b>56.50.14</b>	106	<b>56.85.51</b>	108	<b>58.19.40</b>	97
<b>56.50.15</b>	106	<b>56.85.53</b>	108	<b>58.19.45</b>	97
<b>56.50.19</b>	106	<b>56.85.54</b>	108	<b>58.20.60</b>	63
<b>56.50.25</b>	106	<b>56.85.56</b>	108	<b>58.20.64</b>	63
<b>56.50.29</b>	106	<b>56.85.57</b>	108	<b>58.20.70</b>	34
<b>56.50.30</b>	106	<b>56.85.58</b>	108	<b>58.20.71</b>	34
<b>56.50.40</b>	106	<b>56.85.59</b>	108	<b>58.20.91</b>	97
<b>56.60.16</b>	117	<b>56.85.67</b>	109	<b>58.20.95</b>	97
<b>56.74.06</b>	113	<b>56.85.68</b>	109	<b>58.30.26</b>	208
<b>56.74.09</b>	113	<b>56.85.70</b>	109	<b>58.30.31</b>	207
<b>56.75.09</b>	113	<b>56.85.71</b>	109	<b>58.30.32</b>	207
<b>56.76.09</b>	113	<b>56.85.73</b>	109	<b>58.30.35</b>	207
<b>56.77.09</b>	113	<b>56.85.74</b>	109	<b>58.30.36</b>	207
<b>56.78.01</b>	114	<b>56.85.76</b>	109	<b>58.32.03</b>	208
<b>56.78.02</b>	114	<b>56.85.77</b>	109	<b>58.32.04</b>	208
<b>56.78.03</b>	114	<b>56.85.80</b>	107	<b>58.32.13</b>	208
<b>56.78.04</b>	114	<b>56.85.81</b>	107	<b>58.32.18</b>	208
<b>56.79.00</b>	112	<b>56.85.87</b>	107	<b>58.36.02</b>	80
<b>56.80.04</b>	115	<b>56.85.88</b>	107	<b>58.36.03</b>	80
<b>56.80.06</b>	115	<b>56.85.91</b>	110	<b>58.52.02</b>	117
<b>56.80.14</b>	115	<b>56.85.93</b>	110	<b>58.52.09</b>	117
<b>56.81.04</b>	115	<b>56.85.96</b>	107	<b>58.52.19</b>	117
<b>56.81.06</b>	115	<b>56.85.97</b>	107	<b>58.52.29</b>	117
<b>56.82.10</b>	116	<b>56.85.98</b>	110	<b>59.20.40</b>	97
<b>56.82.11</b>	116	<b>56.86.36</b>	107	<b>59.20.45</b>	97
<b>56.82.12</b>	116	<b>56.86.37</b>	107	<b>59.23.42</b>	97
<b>56.82.13</b>	116	<b>56.86.58</b>	108	<b>59.23.45</b>	97
<b>56.82.14</b>	116	<b>56.86.59</b>	108	<b>59.45.15</b>	58







**Numerischer Index**  
**Numerical Index**  
**Indice numérico**  
**Index numérique**  
**Indice numérico**

21

<b>59.45.18</b>	58	<b>204.13.13</b>	13	<b>204.35.73</b>	20
<b>59.45.21</b>	58	<b>204.13.15</b>	13	<b>204.54.16</b>	10
<b>59.46.15</b>	58	<b>204.13.18</b>	13	<b>204.54.66</b>	10
<b>59.46.18</b>	58	<b>204.13.62</b>	12	<b>204.55.16</b>	10
<b>59.46.21</b>	58	<b>204.13.63</b>	13	<b>204.55.66</b>	10
<b>59.47.15</b>	58	<b>204.13.65</b>	13	<b>204.67.12</b>	21
<b>59.47.18</b>	58	<b>204.13.68</b>	13	<b>204.67.16</b>	21
<b>59.47.21</b>	58	<b>204.24.14</b>	14	<b>204.67.18</b>	21
<b>59.48.15</b>	58	<b>204.24.64</b>	14	<b>204.73.17</b>	27
<b>59.48.18</b>	58	<b>204.25.14</b>	14	<b>204.73.19</b>	27
<b>59.48.21</b>	58	<b>204.25.64</b>	14	<b>204.73.23</b>	27
<b>59.49.15</b>	59	<b>204.32.11</b>	14	<b>204.75.17</b>	28
<b>59.49.18</b>	59	<b>204.32.14</b>	15	<b>204.75.19</b>	28
<b>59.49.21</b>	59	<b>204.32.18</b>	15	<b>204.75.23</b>	28
<b>59.49.25</b>	59	<b>204.32.20</b>	15	<b>205.15.74</b>	37
<b>59.49.28</b>	59	<b>204.32.23</b>	17	<b>205.18.70</b>	36
<b>59.49.31</b>	59	<b>204.32.26</b>	17	<b>205.18.71</b>	36
<b>60.05.10</b>	209	<b>204.32.30</b>	17	<b>212.20.11</b>	9
<b>60.05.11</b>	209	<b>204.32.61</b>	14	<b>212.21.11</b>	9
<b>60.05.12</b>	209	<b>204.32.64</b>	15	<b>212.40.12</b>	12
<b>60.05.13</b>	209	<b>204.32.68</b>	15	<b>212.41.12</b>	12
<b>60.05.14</b>	209	<b>204.32.70</b>	15	<b>212.50.12</b>	9
<b>66.53.32</b>	80	<b>204.32.73</b>	17	<b>212.50.13</b>	9
<b>68.04.86</b>	103	<b>204.33.11</b>	14	<b>214.13.12</b>	12
<b>76.01.02</b>	104	<b>204.33.14</b>	16	<b>214.13.13</b>	13
<b>76.01.03</b>	104	<b>204.33.15</b>	16	<b>214.13.15</b>	13
<b>76.01.04</b>	104	<b>204.33.18</b>	16	<b>214.13.18</b>	13
<b>76.01.05</b>	104	<b>204.33.20</b>	16	<b>214.32.11</b>	14
<b>76.01.06</b>	104	<b>204.33.23</b>	18	<b>214.32.14</b>	15
<b>76.01.07</b>	104	<b>204.33.26</b>	18	<b>214.32.18</b>	15
<b>76.01.08</b>	104	<b>204.33.30</b>	18	<b>214.32.20</b>	15
<b>76.01.09</b>	104	<b>204.33.61</b>	14	<b>214.32.23</b>	17
<b>76.01.10</b>	104	<b>204.33.64</b>	16	<b>214.32.26</b>	17
<b>76.01.12</b>	104	<b>204.33.68</b>	16	<b>214.32.30</b>	17
<b>76.01.15</b>	104	<b>204.33.70</b>	16	<b>214.33.11</b>	14
<b>76.01.18</b>	104	<b>204.33.73</b>	18	<b>214.33.14</b>	16
<b>76.01.20</b>	104	<b>204.33.76</b>	18	<b>214.33.15</b>	16
<b>76.45.10</b>	103	<b>204.33.80</b>	18	<b>214.33.18</b>	16
<b>76.45.15</b>	103	<b>204.34.14</b>	19	<b>214.33.20</b>	16
<b>76.45.19</b>	103	<b>204.34.18</b>	19	<b>214.33.23</b>	18
<b>76.45.73</b>	101	<b>204.34.20</b>	19	<b>214.33.26</b>	18
<b>76.45.85</b>	101	<b>204.34.23</b>	19	<b>214.33.30</b>	18
<b>202.20.11</b>	9	<b>204.34.64</b>	19	<b>214.34.14</b>	19
<b>202.20.61</b>	9	<b>204.34.68</b>	19	<b>214.34.18</b>	19
<b>202.21.11</b>	9	<b>204.34.70</b>	19	<b>214.34.20</b>	19
<b>202.21.61</b>	9	<b>204.34.73</b>	19	<b>214.34.23</b>	19
<b>202.40.12</b>	12	<b>204.35.14</b>	20	<b>214.35.14</b>	20
<b>202.40.62</b>	12	<b>204.35.18</b>	20	<b>214.35.18</b>	20
<b>202.41.12</b>	12	<b>204.35.20</b>	20	<b>214.35.20</b>	20
<b>202.41.62</b>	12	<b>204.35.23</b>	20	<b>214.35.23</b>	20
<b>202.50.12</b>	9	<b>204.35.26</b>	21	<b>214.54.16</b>	10
<b>202.50.13</b>	9	<b>204.35.28</b>	21	<b>214.55.16</b>	10
<b>204.10.11</b>	10	<b>204.35.64</b>	20	<b>214.67.12</b>	21
<b>204.11.11</b>	10	<b>204.35.68</b>	20	<b>214.67.16</b>	21
<b>204.13.12</b>	12	<b>204.35.70</b>	20	<b>214.67.18</b>	21



<b>214.73.17</b>	27	<b>255.15.46</b>	30
<b>214.73.19</b>	27	<b>390.10.10</b>	103
<b>214.73.23</b>	27		
<b>214.75.17</b>	28		
<b>214.75.19</b>	28		
<b>214.75.23</b>	28		
<b>222.20.61</b>	9		
<b>222.21.61</b>	9		
<b>222.40.62</b>	12		
<b>222.41.62</b>	12		
<b>222.50.62</b>	9		
<b>222.50.63</b>	9		
<b>224.10.61</b>	10		
<b>224.11.61</b>	10		
<b>224.13.62</b>	12		
<b>224.32.61</b>	14		
<b>224.32.64</b>	15		
<b>224.32.68</b>	15		
<b>224.32.70</b>	15		
<b>224.32.73</b>	17		
<b>224.33.61</b>	14		
<b>224.33.64</b>	16		
<b>224.33.68</b>	16		
<b>224.33.70</b>	16		
<b>224.33.73</b>	18		
<b>224.33.80</b>	18		
<b>224.35.64</b>	20		
<b>224.35.68</b>	20		
<b>224.35.70</b>	20		
<b>224.35.73</b>	20		
<b>224.54.66</b>	10		
<b>224.55.66</b>	10		
<b>224.67.66</b>	21		
<b>224.67.68</b>	21		
<b>224.73.67</b>	27		
<b>224.73.69</b>	27		
<b>224.73.73</b>	27		
<b>224.75.67</b>	28		
<b>224.75.69</b>	28		
<b>224.75.73</b>	28		
<b>225.15.32</b>	31		
<b>225.15.34</b>	31		
<b>225.15.36</b>	31		
<b>225.15.39</b>	31		
<b>225.19.25</b>	33		
<b>225.19.45</b>	33		
<b>225.19.60</b>	33		
<b>225.19.90</b>	33		
<b>225.19.95</b>	33		
<b>255.15.32</b>	31		
<b>255.15.34</b>	31		
<b>255.15.36</b>	31		
<b>255.15.39</b>	31		
<b>255.15.42</b>	30		
<b>255.15.44</b>	30		

- Alphabetischer Index 
- Alphabetical Index 
- Índice alfabético 
- Index alphabétique 
- Índice alfabético 

**A**

<b>ACLAND</b> Approximatoren	108-109
<b>ACLAND</b> Clip-Anlegepinzetten	110
<b>ACLAND</b> Mikro-Gefäßclips	107-109
<b>ADSON</b> Arterienklemmen	138
<b>ADSON BABY</b> Präparier- und Ligaturklemmen	145
<b>ADSON BECKMANN</b> Wundspreizer	239
<b>ADSON BROWN</b> chirurgische Pinzetten	43
<b>ADSON GRAEFE</b> chirurgische Pinzetten	43
<b>ADSON HALSTED</b> Arterienklemmen	138
<b>ADSON HM</b> anatomische Pinzette	43
<b>ADSON HM</b> chirurgische Pinzette	43
<b>ADSON JACOBSON (KOSHIMA)</b> Mikropinzette	60
<b>ADSON JACOBSON</b> Mikropinzette	59
<b>ADSON MICRO</b> anatomische Pinzette	43
<b>ADSON MICRO</b> chirurgische Pinzette	43
<b>ADSON</b> Wundspreizer	239
<b>ALEXANDER FARABEUF</b> Raspatorium	244
<b>ALLEN KOCHER</b> Arterienklemmen	132
<b>ALLIS AT</b> Gewebefasszangen	202
<b>ALLISON</b> Lungenspatel	228
<b>ALM</b> Wundspreizer	236
Anastomosenklemmen	174-176
Anatomische Pinzetten	42-46
<b>ANDREWS PYNCHON</b> Sauginstrument	67
<b>ANKENEY MEDICON</b> Rippen- und Sternumspreizer	277-278
Anlegepinzetten Clip	110-111, 113-115
Anlegezange für Bulldog-Klemmen	125
Anlegezangen Clip	106, 117
Aorta Aneurysma Klemmen	183-184
Aortadilatatoren	299
Aortahaken	229, 234
Aortaklemmen	166, 189-191
Aortastanzen	304
Approximatoren	108-109, 111-114
Arterienklemmen	128-142
Arterienklemmen Titan	130-131
Atraumatische Bulldog-Klemmen	120-121, 125-127
Atraumatische Klemmen	120-121, 125-127, 129, 132, 135, 153-185, 187-196
Atraumatische Pinzetten	47-55
Atriumhaken	230-233
Aurikelklemme	169
<b>AUSTIN</b> Mikroknüpfpinzette	64

**B**

<b>BABCOCK AT</b> Gewebefasszangen	204
<b>BABCOCK BABY</b> Gewebefasszange	203
<b>BABCOCK</b> Gewebefasszangen	203
<b>BABCOCK HM</b> Gewebefasszangen	203
<b>BABY ADSON</b> Präparier- und Ligaturklemmen	145
<b>BABY BABCOCK</b> Gewebefasszangen	203

<b>BABY CRILE</b> Arterienklemmen	128
<b>BABY CRILE WOOD HM</b> Nadelhalter	83
<b>BABY DEAVER</b> Wundhaken und Lungenspatel	222
<b>BABY FINOCHIETTO HAIGHT</b> Rippen- und Sternumspreizer	279
<b>BABY HAIGT</b> Rippen- und Sternumspreizer	281
<b>BABY HARRINGTON</b> Wundhaken und Lungenspatel	221
<b>BABY KOCHER</b> Arterienklemmen	128
<b>BABY METZENBAUM</b> Präparierscheren	14
<b>BABY MIXTER</b> Präparier- und Ligaturklemmen	145
<b>BABY PEAN</b> Arterienklemmen	128
<b>BABY SATINSKY</b> Vena-Cava-Klemme	186
<b>BAILEY</b> Aortastanze	304
<b>BAILEY GIBBON</b> Rippenspreizer	264
<b>BAILEY</b> Rippenspreizer	264
<b>BAINBRIDGE DEBAKEY AT</b> Arterienklemmen	132
<b>BARRAQUER</b> Mikronadelhalter	92
Bauch-Aorta-Klemmen	164-165
<b>BAUMGARTNER HM</b> Nadelhalter	83
<b>BECK DEBAKEY AT</b> Vena-Cava-Klemmen	188
<b>BECKMANN ADSON</b> Wundspreizer	239
<b>BECKMANN EATON</b> Wundspreizer	239
<b>BECKMANN WEITLANER</b> Wundspreizer	238
<b>BECKMANN</b> Wundspreizer	238
<b>BELMONT RUMEL</b> Tourniquets	298
<b>BENGOLEA</b> Arterienklemmen	141
<b>BETHUNE CORYLLOS (COLLIN)</b> Rippenscheren	258
<b>BETHUNE</b> Rippenscheren	259
<b>BIEMER</b> Approximatoren	111-112
<b>BIEMER</b> Clip-Anlegepinzetten	111, 113, 114
<b>BIEMER</b> Gefäßspreizer	117
<b>BIEMER</b> Mikro-Gefäßclips	111
<b>BIEMER</b> Venenschere	39
<b>BIEMER MÜLLER</b> Approximatoren	113
<b>BIEMER MÜLLER</b> Mikro-Gefäßclips	113
<b>BIEMER</b> Nerv-Approximatoren	112
<b>BLACK LINE</b> Scheren	9-10, 12-21, 27-28
<b>BLANK</b> anatomische Pinzetten	42
<b>BOYD</b> Gefäßschere	25
<b>BOZEMANN (WERTHEIM) HM</b> Nadelhalter	87
<b>BRIDGE</b> Arterienklemmen	140
Bronchusklemmen	151-154
<b>BROPHY</b> anatomische Pinzetten	45
<b>BROPHY</b> chirurgische Pinzetten	45
<b>BROWN ADSON</b> chirurgische Pinzetten	43
<b>BROWN</b> Gewebefasspinzetten	57
<b>BRUNNER</b> Rippenscheren	261
Bulldog-Klemmen	120-127, 155
Bulldog-Klemmen atraumatisch	120-121, 125-127
Bulldog-Klemmen Titan	120-121
<b>BURFORD</b> Rippen- und Sternumspreizer	271-273

**C**

Carotisklemmen	166-167
<b>CASTANEDA AT</b> Neonataalklemmen	196

<b>CASTANEDA STERNAL</b> Rippen- und Sternumspreizer	283
<b>CASTROVIEJO (KOSHIMA)</b> Mikronadelhalter	91
<b>CASTROVIEJO HM</b> Mikronadelhalter	91
<b>CASTROVIEJO MICRO</b> Mikronadelhalter	91
<b>CASTROVIEJO</b> Mikronadelhalter	91
Chirurgische Pinzetten	43-46
Clip-Anlegepinzetten	110, 111, 113-115
Clip-Anlegezangen	106, 117
Clip-Anlegezangen für Titan Clips	106
Coarktationsklemmen	172-173
<b>COLLIN CORYLLOS BETHUNE</b> Rippenscheren	258
<b>COLLIN DUVAL</b> Gewebefasspinzetten	56
<b>COLLIN</b> Gewebefasszange	200
<b>COOLEY</b> Aortadilatator	299
<b>COOLEY AT</b> Anastomosenklemme	175
<b>COOLEY AT</b> Bronchusklemmen	154
<b>COOLEY AT</b> Coarktationsklemmen	172
<b>COOLEY AT</b> Gefäßklemmen	156-159
<b>COOLEY AT</b> Iliac-Klemmen	169
<b>COOLEY AT</b> Neonatal-Klemmen	192-194
<b>COOLEY AT</b> Nieren-Arterien-Klemmen	181
<b>COOLEY AT</b> Patent-Ductus-Klemmen	170
<b>COOLEY</b> Atriumhaken	330-233
<b>COOLEY DERRA AT</b> Anastomosenklemmen	174
<b>COOLEY GLOVER AT</b> Anastomosenklemme	175
<b>COOLEY GLOVER AT</b> Gefäßklemmen	159
<b>COOLEY</b> Katheterklemmen	197
<b>COOLEY</b> Rippen- und Sternumspreizer	286, 289-295
<b>COOLEY AT</b> Neonataalklemmen	299
<b>COOLEY</b> Sauginstrumente	68
<b>CORWIN HEGAR</b> Drahtspannzange	104
<b>CORYLLOS BETHUNE (COLLIN)</b> Rippenscheren	258
<b>CORYLLOS</b> Wundhaken	218
<b>CRAFOORD</b> Lungenschere	22
<b>CRAFOORD MIXTER</b> Präparier- und Ligaturklemmen	148
<b>CRAFOORD SELLORS</b> Arterienklemmen	137
<b>CRAWFORD</b> Aortahaken	229
<b>CRILE</b> Arterienklemmen	131
<b>CRILE BABY</b> Arterienklemmen	128
<b>CRILE WOOD BABY HM</b> Nadelhalter	83
<b>CRILE WOOD HM</b> Nadelhalter	84
<b>CUSHING</b> anatomische Pinzette	46
<b>CUSHING</b> chirurgische Pinzette	46
<b>CUSHING</b> Gefäßhäkchen	206
<b>CUSHING HM</b> anatomische Pinzetten	46
<b>CUSHING</b> Nervhäkchen	206
<b>CUSHING</b> Raspatorien	242
<b>CUSHING</b> Venenhaken	209, 212





<b>HARRINGTON PEMBERTON</b>		Klemme Aurikel	169	<b>LAMBERT KAY AT</b> Aortaklemme	191
Wundhaken und Lungenspatel	222	Klemme Subklavia	165	<b>LAMBOTTE</b> Raspatorien	242
<b>HARRINGTON</b> Wundhaken und Lungenspatel	221	Klemmen	120-197	<b>LANGENBECK HM</b> Nadelhalter	90
<b>HEANEY HM</b> Nadelhalter	87	Klemmen Anastomosen	174-176	<b>LANGENBECK</b> Knochenhaltezeuge	257
<b>HEGAR CORWIN</b> Drahtspannzange	104	Klemmen Aorta	166, 189-191	<b>LANGENBECK KOCHER</b> Wundhaken	216
<b>HEGAR MAYO HM</b> Nadelhalter	83	Klemmen Aorta-Aneurysma	183-184	<b>LANGENBECK</b> Raspatorium	242
<b>HEGEMANN DIETRICH</b> Gefäßscheren	31	Klemmen Arterie	128-142	<b>LANGENBECK</b> Wundhaken	213-215
<b>HEISS</b> Arterienklemmen	139, 142	Klemmen atraumatisch	120-121, 125-127, 129, 132, 135, 153-185, 187-196	<b>LEBSCHKE</b> Sternummeißel	296
<b>HENLY AT</b> Subklavia Arterienklemmen	165			<b>LEES AT</b> Bronchusklemmen	153
<b>HM</b> Scheren	9-10, 12-20, 33	Klemmen Bauch-Aorta	164-165	<b>LEKSELL</b> Hohlmeißelzangen	250
Hohlmeißelzangen	247-251	Klemmen Bronchus	151-154	<b>LELAND JONES AT</b> Peripheralgefäßklemmen	177
<b>HÖPFNER</b> Gefäßklemmen	159	Klemmen Bulldog	120-127	<b>LEMMON</b> Gefäßspatel	78
<b>HOPKINS JOHN</b> Bulldogklemmen	124	Klemmen Carotis	166-167	<b>LEMOLE AT</b> Aortaklemmen	166
<b>HOPT AT</b> Nierenarterienklemmen	182	Klemmen Coarktation	172-173	<b>LERICHE</b> Arterienklemmen	131
<b>HUSFELDT DEBAKEY AT</b>	166-167	Klemmen Gefäß	155-197	<b>LICHTENBERG HM</b> Nadelhalter	90
Carotisklemmen		Klemmen Iliac	169	Ligaturklemmen	143-150, 185
		Klemmen Katheter	197	Ligaturscheren	40
<b>I</b>		Klemmen Ligatur	143-150, 184-185	<b>LISTON KEY</b> Knochensplitterzange	254
Iliac-Klemmen	169	Klemmen Mehrzweck	156-163	<b>LISTON</b> Knochensplitterzangen	252
<b>IMA</b> -Spreizer	265-267	Klemmen Neonatal	192-196	<b>LISTON RUSKIN</b> Knochensplitterzangen	253
<b>INFANT FINOCHIETTO</b>		Klemmen Nierenarterie	181-182	<b>LISTON STILLE</b> Knochensplitterzangen	254
Rippen- und Sternumspreizer	279	Klemmen Patent-Ductus	170-171	<b>LITTAUER</b> Knochensplitterzange	253
Instrumenten-Pflegeöl	321	Klemmen Peripheralgefäß	177-180	<b>LOCKLIN</b> Gewebescherer	23
Instrumenten-Tray	320	Klemmen Präparier	143-150	<b>LOVE (MORSE)</b> Wund- und Gefäßhäkchen	212
<b>INTRACARDIAC HM</b> Nadelhalter	85	Klemmen Tangentialverschluß	168	<b>LOVELACE</b> Arterienklemme	133
		Klemmen Titan	120-121, 130-131	<b>LOVELACE DIXON</b> Arterienklemme	133
		Klemmen Vena-Cava	186-188	<b>LUCAE</b> Gefäßhäkchen	206
		<b>KLINKENBERGH</b> Gefäßschere	24	<b>LUER STILLE</b> Hohlmeißelzangen	248
		Knochendrähte	104	Lungenhaken	229
		Knochenhaltezeugen	255-257	Lungenscheren	22-23
		Knochensplitterzangen	252-254	Lungenspatel	221-228
		Knüppelpinzetten	64		
		<b>KOCHER ALLEN</b> Arterienklemmen	132	<b>M</b>	
		<b>KOCHER</b> Arterienklemmen	133	<b>MAGIC CUT</b> Scheren	9-10, 12, 14-18, 20, 27-28, 31
		<b>KOCHER BABY</b> Arterienklemmen	128	<b>MARBERGER</b> Wund- und Gefäßhäkchen	210
		<b>KOCHER LANGENBECK</b> Wundhaken	216	<b>MASSON HM</b> Nadelhalter	88
		<b>KOCHER ROCHESTER OCHSNER</b>		<b>MATHIEU HM</b> Nadelhalter	90
		Arterienklemmen	136	<b>MATHIEU RYDER MICRO HM</b>	
		<b>KOENIG</b> Wund- und Gefäßhäkchen	209	Nadelhalter	90
		<b>KOSHIMA CASTROVIEJO</b>		<b>MATSON</b> Raspatorium	244
		Mikronadelhalter	91	<b>MAYO</b> Gewebefasspinzette	57
		<b>KOSHIMA JACOBSON ADSON</b>		<b>MAYO HEGAR HM</b> Nadelhalter	83
		Mikropinzette	60	<b>MAYO</b> Krampfaderinstrumente	74
		<b>KOSHIMA MICRO JACOBSON</b>		<b>MCINDOE</b> anatomische Pinzette	45
		Arterienklemmen	129	<b>MCINDOE</b> Knochensplitterzangen	253
		<b>KOSHIMA</b> Mikropinzetten	60	<b>MEDICON ANKENEY</b>	
		<b>KOSHIMA</b> Mikroscheren	35	Rippen- und Sternumspreizer	277-278
		Krampfaderbestecke	72-73	<b>MEDICON</b> Drahtspannzange	102
		Krampfaderinstrumente	72-74	<b>MEDICON FINOCHIETTO</b>	
		<b>KRAYENBÜHL</b> Gefäßhäkchen	207	Rippen- und Sternumspreizer	280
				<b>MEDICON HM</b> Drahtspannzange	102
		<b>L</b>		<b>MEDICON IMA</b> -Spreizer	266-267
		<b>LAHEY</b> Präparier- und Ligaturklemme	145, 148	<b>MEDICON MORSE STERNAL</b>	
		<b>LAHEY SWEET</b>		Rippen- und Sternumspreizer	270
		Präparier- und Ligaturklemmen	148	<b>MEDICON PACKER (SKILLMAN)</b>	
		<b>LAHEY</b> Wundhaken	213	Arterienklemmen	130
<b>K</b>					
<b>KADER</b> Wund- und Lungenspatel	227				
Katheterklemmen	197				
<b>KAY LAMBERT AT</b> Aortaklemme	191				
<b>KELLY</b> feine Scheren	10				
<b>KELLY</b> Wundhaken	219				
<b>KEY LISTON</b> Knochensplitterzange	254				
<b>KILNER RAGNELL</b> Präparierscheren	13				



<b>MEDICON</b> Rippenspreizer	264	<b>N</b>			
<b>MEDICON</b> Wundspreizer	236	<b>NABATOFF</b> Krampfaderbesteck	73	Pinzetten anatomisch	42-46
<b>MEEKER</b> Arterienklemme	140	Nadelhalter	81-97	Pinzetten atraumatisch	47-55
<b>MEHDORN</b> Mikro-Gefäßclips	115	Nadelhalter Erläuterung	82	Pinzetten atraumatisch Titan	53-55
Mehrzweckklemmen	156-163	Nadelhalter HM	83-92	Pinzetten chirurgisch	43-46
<b>MERZ</b> Aortastanze	304	Nadelhalter Mikro	91-97	Pinzetten fein	43-45
<b>METZENBAUM BABY</b> Präparierscheren	14	Nahtpinzetten	61, 63	Pinzetten Gefäß	48-55
<b>METZENBAUM</b> Präparierscheren	15-16	<b>NELSON</b> Gewebefasspinzette	56	Pinzetten Gewebefass	56-57
<b>METZENBAUM SLIM</b> Präparierscheren	19-21	<b>NELSON</b> Präparierscheren	17-18	Pinzetten Knüpf	64
<b>MICRO 2000 (KOSHIMA)</b> Mikropinzette	60	<b>NEONATAL</b> AT Neonatalklemmen	192-193	Pinzetten Mikro	58-64
<b>MICRO 2000</b> Mikronadelhalter	95-97	<b>NEONATAL CASTANEDA AT</b>		Pinzetten Naht	61, 63
<b>MICRO 2000</b> Mikropinzetten	60-63	Neonatalklemmen	196	<b>POTTS</b> Coarktationsklemmen	172
<b>MICRO 2000</b> Mikroscheren	34-36	Neonatalklemmen	192-196	<b>POTTS DEMARTEL</b> Gefäßschere	32
<b>MICRO ADSON</b> anatomische Pinzette	43	Nerv-Approximatoren	112	<b>POTTS GLOVER</b> Anastomosenklemme	175
<b>MICRO ADSON</b> chirurgische Pinzette	43	Nervhäkchen	206	<b>POTTS GLOVER</b> Gefäßklemmen	160
<b>MICRO CASTROVIEJO</b> Mikronadelhalter	91	Nierenarterienklemmen	181-182	<b>POTTS</b> Patent-Ductus-Klemmen	170
<b>MICRO HALSTED</b> Arterienklemmen	128	<b>NIRO</b> Drahtspannzange	102	<b>POTTS SATINSKY</b> Anastomosenklemme	175
<b>MICRO JACOBSON (KOSHIMA)</b>		<b>NIRO HM</b> Drahtspannzange	102	<b>POTTS SATINSKY</b> Vena-Cava-Klemmen	187
Arterienklemmen	129	<b>NISSEN HARKEN</b>		<b>POTTS SMITH</b> anatomische Pinzetten	45
<b>MICRO JACOBSON</b> Arterienklemmen	138	Rippen- und Sternumspreizer	284	<b>POTTS SMITH</b> chirurgische Pinzetten	45
<b>MICRO SLIM HM</b> Nadelhalter	85	<b>O</b>		<b>POTTS SMITH</b> Gefäßscheren	26, 30
<b>MICROVASCULAR HM</b> Nadelhalter	86	<b>O'SHAUGNESSY</b> Ligaturklemme	146	<b>POTTS SMITH HM</b> anatomische Pinzetten	42
Mikro-Gefäßclips	107-109, 111-115	<b>OBWEGESER</b> Flachzange	103	Präparierklemmen	143-150
Mikro-Knüpfpinzetten	64	<b>OBWEGESER</b> Raspatorien	246	Präparierscheren	12-21
Mikronadelhalter	91-97	<b>OCHSNER ROCHESTER KOCHER</b>		<b>PRICE THOMAS</b> Bronchusklemmen	151
Mikronadelhalter Titan	94	Arterienklemmen	136	<b>PYNCHON ANDREWS</b> Sauginstrument	67
Mikropinzetten	58-64	<b>OVERHOLT GEISSENDOERFER</b>		<b>R</b>	
Mikropinzetten Titan	58	Präparier- und Ligaturklemmen	143	<b>RAGNELL (KILNER)</b> Präparierscheren	13
Mikroscheren	33-39	<b>OVERHOLT MIOTTI</b>		Raspatorien	242-246
Mikroscheren Titan	38	Präparier- und Ligaturklemmen	144	<b>REYNOLDS (JAMESON)</b> Präparierscheren	21
<b>MIKULICZ</b> Wundhaken	219-220	<b>OVERHOLT MIXTER</b>		<b>RIENHOFF FINOCHIETTO</b>	
<b>MILLESI</b> Mikroscheren	39	Präparier- und Ligaturklemme	146	Rippen- und Sternumspreizer	281
<b>MILLS</b> Gefäßschere	32	<b>OVERHOLT SLIM</b>		Rippen- und Sternumspreizer	265-295
<b>MINI RYDER HM</b> Nadelhalter	85	Präparier- und Ligaturklemmen	144	Rippenkontraktoren	264
<b>MIOTTI OVERHOLT</b>		<b>P</b>		Rippenscheren	258-261
Präparier- und Ligaturklemmen	144	<b>PACKER MEDICON (SKILLMAN)</b>		Rippenspreizer	264
<b>MIXTER BABY</b>		Arterienklemmen	130	<b>ROCHESTER OCHSNER KOCHER</b>	
Präparier- und Ligaturklemmen	145	Patent-Ductus-Klemmen	170-171	Arterienklemmen	136
<b>MIXTER CRAFOORD</b>		<b>PEAN</b> Arterienklemmen	133	<b>ROCHESTER PEAN</b> Arterienklemmen	134
Präparier- und Ligaturklemmen	148	<b>PEAN AT</b> Arterienklemmen	135	<b>ROSS</b> Aortahaken	234
<b>MIXTER OVERHOLT</b>		<b>PEAN BABY</b> Arterienklemmen	128	<b>RUMEL BELMONT</b> Tourniquets	298
Präparier- und Ligaturklemme	146	<b>PEAN DEBAKEY AT</b> Arterienklemmen	135	<b>RUSKIN LISTON</b> Knochensplitterzangen	253
<b>MIXTER</b>		<b>PEAN ROCHESTER</b> Arterienklemmen	134	<b>RYDER (FRENCH EYE) HM</b> Nadelhalter	85
Präparier- und Ligaturklemmen	145, 149	<b>PEMBERTON HARRINGTON</b>		<b>RYDER MATHIEU MICRO HM</b> Nadelhalter	90
<b>MOLDESTAD</b> Gefäßhäkchen	206	Wundhaken und Lungenspatel	222	<b>RYDER MINI HM</b> Nadelhalter	85
<b>MORSE FAVALORO STERNAL</b>		Peripheralgefäßklemmen	177-180	<b>RYDER SLIM HM</b> Nadelhalter	86
Rippen- und Sternumspreizer	269	<b>PERWIZSCHKY</b> Gefäßscheren	24		
<b>MORSE LOVE</b> Wund- und Gefäßhäkchen	212	<b>PETERSEN SMITH</b> Hohlmeißelzangen	248	<b>S</b>	
<b>MORSE MEDICON STERNAL</b>		Pflegeöl für Instrumente	321	<b>SACHS</b> Gefäßspatel	78
Rippen- und Sternumspreizer	270	Phlebodissektor	73	<b>SAROT</b> Arterienklemmen	137
<b>MORSE STERNAL</b>		Phleboextraktoren	73	<b>SAROT</b> Bronchusklemmen	152
Rippen- und Sternumspreizer	268	Pinzetten	41-64	<b>SAROT HM</b> Nadelhalter	84
<b>MOSQUITO AT</b> Arterienklemmen	129			<b>SATINSKY BABY</b> Vena-Cava-Klemme	186
<b>MOSQUITO HALSTED</b>				<b>SATINSKY DEBAKEY AT</b>	
Arterienklemmen	130			Vena-Cava-Klemmen	187
<b>MÜLLER</b> Approximatoren	114				
<b>MÜLLER</b> Gefäßclips	116				
<b>MÜLLER</b> Mikro-Gefäßclips	114				
<b>MYERS</b> Krampfaderinstrumente	74				

<b>SATINSKY</b> Gefäßschere	24, 26	<b>SMITH POTTS</b> anatomische Pinzetten	45	<b>U</b>	
<b>SATINSKY POTTS</b> Anastomosenklemme	175	<b>SMITH POTTS</b> chirurgische Pinzetten	45	<b>ULTRA</b> Arterienklemme	129
<b>SATINSKY POTTS</b> Vena-Cava-Klemmen	187	<b>SMITH POTTS</b> Gefäßscheren	26, 30	<b>UNIVERSAL</b> Drahtscheren	100
<b>SATINSKY</b> Vena-Cava-Klemme	186	<b>SMITH POTTS HM</b> anatomische Pinzetten	42	<b>UNIVERSAL</b> Drahtspannzange	103
<b>SAUERBRUCH</b> Rippenschere	260	Spatel Lunge	221-228	<b>UNIVERSAL HM</b> Drahtscheren	100
<b>SAUERBRUCH</b> Wundhaken	217	Spreizer IMA	265-267	Unterminierscheren	10
Saug- und Spülrohre	69	Spreizer Rippen	264-295		
Sauginstrumente	66-69	Spreizer Wund	236-239		
Scheren	1-40	Stanzen Aorta	304		
Scheren blackline	9-10, 12-21, 27-28	<b>STERNAL CASTANEDA</b>		<b>V</b>	
Scheren chirurgisch	11	Rippen- und Sternumspreizer	283	Valvulotome	305
Scheren Draht	100	<b>STERNAL MEDICON MORSE</b>		<b>VARADY</b> Phlebo dissektor	73
Scheren Erläuterung	2-8	Rippen- und Sternumspreizer	270	<b>VARADY</b> Phleboextraktor	73
Scheren fein	9-10	<b>STERNAL MORSE FAVALORO</b>		Vena-Cava-Klemmen	186-188
Scheren Gefäß	24-32	Rippen- und Sternumspreizer	269	Venenhäkchen	206, 209
Scheren Gewebe	23	<b>STERNAL MORSE</b>		Venenhaken	209, 212
Scheren HM	9-10, 12-20, 33	Rippen- und Sternumspreizer	268	Veneninstrumente	73
Scheren Ligatur	40	Sternummeißel	296	Venenschere	39
Scheren Lunge	22-23	Sternumspreizer	265-295	Venenstripper	74
Scheren magic cut	9-10, 12, 14-18, 20, 27-28, 31	<b>STEVENS</b> feine Scheren	9	<b>VERNET GIL</b> Wund- und Gefäßhäkchen	211
Scheren Mikro	33-39	<b>STILLE</b> Hohlmeißelzange	249		
Scheren Präparier	12-21	<b>STILLE LISTON</b> Knochensplitterzangen	254		
Scheren Rippen	258-261	<b>STILLE LUER</b> Hohlmeißelzangen	248	<b>W</b>	
Scheren supercut	9-12, 12-21, 27-28, 30-31, 36-37	<b>STILLE SEMB</b> Hohlmeißelzange	249	<b>WANGENSTEEN</b> Gewebefasspinzetten	57
Scheren supercut plus	9-10, 12-20	<b>STRATTE HM</b> Nadelhalter	87	<b>WANGENSTEEN HM</b> Gewebefasspinzetten	57
Scheren unterminier	10	<b>STRUCK</b> Rippen- und Sternumspreizer	275	<b>WANGENSTEEN HM</b> Nadelhalter	89
<b>SCHMID</b> Gefäßspatel	78	<b>STRULLY</b> Gefäßschere	27	<b>WEBER AT</b> Aortaklemmen	190
<b>SCHMID</b> Gefäßspülkanülen	76	Subklavia Arterienklemme	165	<b>WEITLANER BECKMANN</b> Wundspreizer	238
<b>SCHOENBORN</b> Wundhaken	213	<b>SUBRAMANIAN DEBAKEY AT</b>		<b>WEITLANER</b> Wundspreizer	236-237
<b>SCHWARTZ</b> Clip-Anlegezange	117	Neonatakllemmen	195	<b>WERTHEIM BOZEMANN HM</b> Nadelhalter	87
<b>SCHWARTZ</b> Gefäßclips	117	<b>SUBRAMANIAN</b> Neonatakllemmen	195	<b>WIKSTROEM</b> Präparier- und Ligaturklemme	146
<b>SELECT</b> anatomische Pinzetten	44	<b>SUPERCUT PLUS</b> Scheren	9-10, 12-20	<b>WILLAUER</b> Lungenschere	22
<b>SELECT</b> chirurgische Pinzetten	44	<b>SUPERCUT</b> Scheren	9-12, 12-21, 27-28, 30-31, 36-37	<b>WILLIAMS</b> Gewebefasszange	202
<b>SELLORS CRAFOORD</b> Arterienklemmen	137	<b>SWEET LAHEY</b> Präparier- und Ligaturklemmen	148	<b>WOOD CRILE HM</b> Nadelhalter	84
<b>SELLORS</b> Rippenspreizer	264	<b>SYPERT</b> Hohlmeißelzange	251	Wundhaken	209-227
<b>SEMB AT</b> Ligaturklemme	185			Wundspreizer	235-239
<b>SEMB DEBAKEY AT</b> Ligaturklemme	185	<b>T</b>		<b>WYLIE AT</b> Bauch-Aortaklemmen	164
<b>SEMB</b> Knochenhalte zangen	257	Tangential-Verschluß-Klemmen	168		
<b>SEMB</b> Lungenhaken	229	<b>THOMAS PRICE</b> Bronchusklemmen	151	<b>Y</b>	
<b>SEMB</b> Präparier- und Ligaturklemmen	150	Titan Arterienklemmen	130-131	<b>YANKAUER</b> Sauginstrumente	66-67
<b>SEMB</b> Raspatorien	243	Titan Bulldogklemmen	120-121	<b>YASARGIL</b> Mikronadelhalter	95, 97
<b>SEMB STILLE</b> Hohlmeißelzange	249	Titan Gefäß-Clips	106	<b>YASARGIL</b> Mikroscheren	34, 39
<b>SEMKEN</b> chirurgische Pinzetten	44	Titan Klemmen	120-121, 130-131	<b>YASARGIL POTTS</b> Mikroschere	39
<b>SENNING HM</b> Nadelhalter	88	Titan Mikronadelhalter	94		
<b>SENNING</b> Nadelhalter	88	Titan Mikropinzetten	58		
<b>SHEA</b> Präparierschere	12	Titan Mikroscheren	38	<b>Z</b>	
Siebvorschläge	307-318	Titan Pinzetten atraumatisch	53-55	Zangen	200-204
<b>SIEGERT</b> feine Scheren	10	Titan klemmen	120-121, 130-31	Zangen Hohlmeißel	247-251
Skapulahaken	229	<b>TOENNIS</b> Gefäßspatel	79	Zangen Knochenhalte	256-257
<b>SKILLMAN MEDICON PACKER</b>		<b>TOENNIS HM</b> Nadelhalter	90	Zangen Knochensplitter	252-254
Arterienklemmen	130	Tourniquets	298	<b>ZANGER AT</b> Bauch-Aortaklemmen	165
<b>SLIM MIKRO HM</b> Nadelhalter	85	Tray für Instrumente	320	<b>ZENKER</b> Wundhaken	217
<b>SLIM OVERHOLT</b>		<b>TUBBS</b> Aortadilatator	299	Zubehör	319-321
Präparier- und Ligaturklemmen	144	<b>TUFFIER</b> Rippen- und Sternumspreizer	288		
<b>SLIM</b> Präparierscheren	14	Tunnelierbesteck	302-303		
<b>SLIM RYDER HM</b> Nadelhalter	86	<b>TUTTLE</b> Gewebefasspinzette	56		
<b>SMITH PETERSEN</b> Hohlmeißelzangen	248				



<b>COOLEY AT</b> Iliac clamps	169	<b>DEBAKEY AT</b> Ligature clamps	184-185	<b>DUVAL HM</b> Tissue grasping forceps	200
<b>COOLEY AT</b> Neonatal clamps	192-194	<b>DEBAKEY AT</b> Patent ductus clamps	171	<b>DUVAL</b> Tissue grasping forceps	56, 200
<b>COOLEY AT</b> Patent ductus clamps	170	<b>DEBAKEY AT</b>			
<b>COOLEY AT</b> Renal Hemostatic clamps	181	Peripheral vascular clamps	177-178, 180		
<b>COOLEY</b> Atrium retractors	230-233	<b>DEBAKEY AT SUBRAMANIAN</b>		<b>E</b>	
<b>COOLEY</b> Catheter clamps	197	Neonatal clamp	195	<b>EASY CUT HM</b> Wire cutting pliers	101
<b>COOLEY DERRA AT</b> Anastomosis clamps	174	<b>DEBAKEY AT</b>		<b>EATON BECKMANN</b>	
<b>COOLEY GLOVER AT</b> Anastomosis clamp	175	Tangential occlusion clamps	168	Self-retaining retractor	239
<b>COOLEY GLOVER AT</b>		<b>DEBAKEY AT</b> Tissue grasping forceps	201	<b>ECHLIN</b> Bone rongeurs	251
Cardiovascular clamp	159	<b>DEBAKEY BAINBRIDGE AT</b>		<b>ELF</b> Fine hook	208
<b>COOLEY</b>		Hemostatic forceps	132	<b>Endarterectomy</b> instruments	75
Rib and sternal retractors	286, 289-295	<b>DEBAKEY BECK AT</b> Vena cava clamps	188	<b>Endarterectomy</b> strippers	75
<b>COOLEY</b> Suction instruments	68	<b>DEBAKEY DERRA AT</b>		<b>Epicardial</b> retractor	236
<b>CORWIN HEGAR</b>		Anastomosis clamps	174	<b>EUFRATE PASQUÉ HM</b> Needle holders	86
Wire twisting forceps	104	<b>DEBAKEY GLOVER AT</b>			
<b>CORYLLOS BETHUNE (COLLIN)</b>		Anastomosis clamps	176	<b>F</b>	
Rib shears	258	<b>DEBAKEY GLOVER AT</b> Auricle clamp	169	<b>FARABEUF ALEXANDER</b> Raspatory	244
<b>CORYLLOS</b> Retractors	218	<b>DEBAKEY GLOVER AT</b>		<b>FAVALORO MORSE STERNAL</b>	
<b>CRAFOORD</b> Lobectomy scissors	22	Cardiovascular clamps	159-160	Rib and sternal retractors	269
<b>CRAFOORD MIXTER</b>		<b>DEBAKEY HARKEN AT</b>		<b>FAVALORO</b> Vascular scissors	32
Dissecting and ligature forceps	148	Vena cava clamps	188	<b>FERGUSSON</b> Bone holding forceps	257
<b>CRAFOORD SELLORS</b> Hemostatic forceps	137	<b>DEBAKEY HM</b> Needle holders	84	<b>FINOCHIETTO BABY HAIGHT</b>	
<b>CRAWFORD</b> Aorta retractors	229	<b>DEBAKEY HM</b> Vascular scissors	29	Rib and sternal retractors	279
<b>CRILE</b> Hemostatic forceps	131	<b>DEBAKEY PEAN AT</b> Hemostatic forceps	135	<b>FINOCHIETTO</b>	
<b>CRILE BABY</b> Hemostatic forceps	128	<b>DEBAKEY</b> Rib and sternal retractors	274	Dissecting and ligature forceps	150
<b>CRILE WOOD BABY HM</b> Needle holder	83	<b>DEBAKEY SATINSKY AT</b>		<b>FINOCHIETTO HM</b> Needle holder	89
<b>CRILE WOOD HM</b> Needle holders	84	Vena cava clamps	187	<b>FINOCHIETTO INFANT</b>	
<b>CUSHING</b> Dressing forceps	46	<b>DEBAKEY SEMB AT</b> Ligature clamp	185	Rib and sternal retractors	279
<b>CUSHING HM</b> Dressing forceps	46	<b>DEBAKEY</b> Suction instruments	67, 69	<b>FINOCHIETTO Lobectomy</b> scissors	23
<b>CUSHING</b> Nerve hooks	206	<b>DEBAKEY</b> Vascular dilators	298	<b>FINOCHIETTO MEDICON</b>	
<b>CUSHING</b> Raspatories	242	<b>DEBAKEY</b> Vascular scissors	26, 29, 32	Rib and sternal retractor	280
<b>CUSHING</b> Tissue forceps	46	<b>DEBOER</b> Rib and sternal retractor	287	<b>FINOCHIETTO</b>	
<b>CUSHING</b> Vein retractors	209, 212	Delicate forceps	43-45	Dissecting and ligature forceps	150
<b>CUSHING</b> Vessel hooks	206	Delicate scissors	9-10	<b>FINOCHIETTO HM</b> Needle holder	89
		<b>DEMARTEL POTTS</b> Vascular scissors	32	<b>FINOCHIETTO INFANT</b>	
<b>D</b>		<b>DEMARTEL</b> Vascular scissors	25	Rib and sternal retractors	279
<b>DALE AT</b> Peripheral vascular clamps	179	<b>DERRA COOLEY AT</b>		<b>FINOCHIETTO Lobectomy</b> scissors	23
<b>DARDIK AT</b> Cardiovascular clamps	161	Anastomosis clamps	174	<b>FINOCHIETTO MEDICON</b>	
<b>DAVIDSON</b> Retractors scapular	229	<b>DERRA DEBAKEY AT</b>		Rib and sternal retractor	280
<b>DAVIS</b> Vascular spatulas	78-79	Anastomosis clamps	174	<b>FINOCHIETTO</b>	
<b>DEAVER BABY</b>		<b>DESMARRES</b>		Rib and sternal retractors	280, 282, 285
Retractors and lung spatulas	222	Wound and vessel retractors	209	<b>FINOCHIETTO RIENHOFF</b>	
<b>DEAVER</b>		<b>DIEFFENBACH</b> Bulldog clamps	123	Rib and sternal retractor	281
Retractors and lung spatulas	223-226	<b>DIETHRICH</b> Bulldog clamps	122	<b>FINSTERER</b>	
<b>DEBAKEY AT</b> Aorta clamps	189	<b>DIETHRICH GREGORY</b>		Aspirating and irrigating tube	69
<b>DEBAKEY AT</b>		Vascular scissors	32	<b>FISCH</b> Fine hooks	208
Aortic aneurysm clamps	183-184	<b>DIETHRICH HEGEMANN</b>		Flat nose pliers	103
<b>DEBAKEY AT</b> Hemostatic forceps	132	Vascular scissors	31	Forceps	42-64, 120-197
<b>DEBAKEY AT</b> Atraumatic forceps	48-55	Dilators	298-299	Forceps hemostatic	128-142
<b>DEBAKEY AT</b>		Dilators vascular	298	Forceps atraumatic	47-55, 120-121, 125-127, 129, 132, 135, 153-185, 187-196
Atraumatic forceps titan	53-55	<b>DINGMANN</b> Bone holding forceps	256	Forceps atraumatic Titanium	53-55
<b>DEBAKEY AT</b> Bulldog clamps	125-126	Dissecting forceps	143-150	Forceps bone cutting	252-254
<b>DEBAKEY AT</b>		Dissecting scissors	12-21	Forceps bone holding	256-257
Cardiovascular clamps	155-156, 162-163	<b>DIXON LOVELACE</b> Hemostatic forceps	133	Forceps clip applying	106, 110-111, 113-115, 117
<b>DEBAKEY AT</b> Coarctation clamps	173	<b>DOYEN</b> Raspatories	245	Forceps delicate	43-45
<b>DEBAKEY AT HUSFELDT</b>		Dressing forceps	42-46	Forceps dissecting	143-150
Carotid clamps	166-167	<b>DUBOST</b> Rib and sternal retractor	276	Forceps dressing	42-46
		<b>DUVAL AT</b> Tissue grasping forceps	201	Forceps grasping	200-204
		<b>DUVAL COLLIN</b> Tissue grasping forceps	56	Forceps ligature	143-150, 184-185
				Forceps micro	58-64
				Forceps suture tying	61, 63-64



Ligature scissors	40	<b>MICRO ADSON</b> Dressing forceps	43	<b>NELSON</b> Tissue grasping forceps	56
<b>LISTON</b> Bone cutting forceps	252	<b>MICRO ADSON</b> Tissue forceps	43	<b>NEONATAL AT</b> Neonatal clamps	192-193
<b>LISTON KEY</b> Bone cutting forceps	254	<b>MICRO CASTROVIEJO</b>		<b>NEONATAL CASTANEDA AT</b>	
<b>LISTON RUSKIN</b> Bone cutting forceps	253	Micro needle holders	91	Neonatal clamps	196
<b>LISTON STILLE</b> Bone cutting forceps	254	Micro forceps	58-64	Neonatal clamps	192-196
<b>LITTAUER</b> Bone cutting forceps	253	Micro forceps titanium	58	Nerve hooks	206
Lobectomy scissors	22-23	<b>MICRO HALSTED</b> Hemostatic forceps	128	<b>NIRO HM</b> Wire twisting forceps	102
<b>LOCKLIN</b> Tissue scissors	23	<b>MICRO JACOBSON (KOSHIMA)</b>		<b>NIRO</b> Wire twisting forceps	102
<b>LOVE (MORSE)</b>		Hemostatic forceps	129	<b>NISSEN HARKEN</b>	
Wound and vessel retractors	212	<b>MICRO JACOBSON</b> Hemostatic forceps	138	Rib and sternal retractor	284
<b>LOVELACE</b> Hemostatic forceps	133	Micro needle holders	91-97		
<b>LOVELACE DIXON</b> Hemostatic forceps	133	Micro needle holders titanium	94		
<b>LUCAE</b> Vessel hooks	206	Micro scissors	33-39		
<b>LUER STILLE</b> Bone rongeurs	248	Micro scissors titanium	38		
Lung retractors	229	<b>MICRO SLIM HM</b> Needle holders	85		
Lung spatulas	221-228	Micro suture tying forceps	64		
		Micro vessel clips	107-109, 111-115		
		<b>MICROVASCULAR HM</b>			
		Needle holders	86		
<b>M</b>		<b>MIKULICZ</b> Retractors	219-220		
<b>MAGIC CUT</b> Scissors	9-10, 12, 14-18, 20-21, 27-28, 31, 33	<b>MILLESI</b> Micro scissors	39	<b>OBWEGESER</b> Flat nose pliers	103
Maintenance oil for instruments	321	<b>MILLS</b> Vascular scissors	32	<b>OBWEGESER</b> Raspatories	246
<b>MARBERGER</b>		<b>MINI RYDER HM</b> Needle holder	85	<b>OCHSNER ROCHESTER KOCHER</b>	
Wound and vessel retractors	210	<b>MIOTTI OVERHOLT</b>		Hemostatic forceps	136
<b>MASSON HM</b> Needle holder	88	Dissecting and ligature forceps	144	Operating scissors	11
<b>MATHIEU HM</b> Needle holders	90	<b>MIXTER BABY</b>		<b>O'SHAUGNESSY</b>	
<b>MATHIEU RYDER MICRO HM</b>		Dissecting and ligature forceps	145	Dissecting and Ligature Forceps	146
Needle holders	90	<b>MIXTER CRAFOORD</b>		<b>OVERHOLT GEISSENDOERFER</b>	
<b>MATSON</b> Raspatory	244	Dissecting and ligature forceps	148	Dissecting and ligature forceps	143
<b>MAYO HEGAR HM</b> Needle holders	83	<b>MIXTER</b>		<b>OVERHOLT MIOTTI</b>	
<b>MAYO</b> Tissue grasping forceps	57	Dissecting and ligature forceps	145, 149	Dissecting and ligature forceps	144
<b>MAYO</b> Varicose vein instruments	74	<b>MIXTER OVERHOLT</b>		<b>OVERHOLT MIXTER</b>	
<b>MCINDOE</b> Bone cutting forceps	253	Dissecting and ligature forceps	146	Dissecting and ligature forceps	146
<b>MCINDOE</b> Dressing forceps	45	<b>MOLDESTAD</b> Vessel hook	206	<b>OVERHOLT SLIM</b>	
<b>MEDICON ANKENEY</b>		<b>MORSE FAVALORO STERNAL</b>		Dissecting and ligature forceps	144
Rib and sternal retractors	277-278	Rib and sternal retractors	269		
<b>MEDICON FINOCHIETTO</b>		<b>MORSE LOVE</b>			
Rib and sternal retractor	280	Wound and vessel retractors	212	<b>PACKER MEDICON (SKILLMAN)</b>	
<b>MEDICON HM</b> Wire twisting forceps	102	<b>MORSE MEDICON STERNAL</b>		Hemostatic forceps	130
<b>MEDICON IMA</b> Spreaders	266-267	Rib and sternal retractors	270	Patent ductus clamps	170-171
<b>MEDICON MORSE STERNAL</b>		<b>MORSE STERNAL</b>		<b>PEAN</b> Hemostatic forceps	133
Rib and sternal retractors	270	Rib and sternal retractors	268	<b>PEAN AT</b> Hemostatic forceps	135
<b>MEDICON PACKER (SKILLMAN)</b>		<b>MOSQUITO AT</b> Hemostatic forceps	129	<b>PEAN BABY</b> Hemostatic forceps	128
Hemostatic forceps	130	<b>MOSQUITO HALSTED</b> Hemostatic forceps	130	<b>PEAN DEBAKEY AT</b> Hemostatic forceps	135
<b>MEDICON</b> Rib spreader	264	<b>MUELLER</b> Approximators	114	<b>PEAN ROCHESTER</b> Hemostatic forceps	134
<b>MEDICON</b> Self-retaining retractors	236	<b>MUELLER</b> Micro vessel clips	114	<b>PEMBERTON HARRINGTON</b>	
<b>MEDICON</b> Wire twisting forceps	102	<b>MUELLER</b> Vessel clips	116	Retractor and lung spatula	222
<b>MEEKER</b> Hemostatic forceps	140	Multipurpose clamps	156-163	Peripheral vascular clamps	177-180
<b>MEHDORN</b> Micro vessel clips	115	<b>MYERS</b> Varicose vein instruments	74	<b>PERWIZSCHKY</b> Vascular scissors	24
<b>MERZ</b> Aorta punch	304			<b>PETERSEN SMITH</b> Bone rongeurs	248
<b>METZENBAUM BABY</b> Dissecting scissors	14			Phleboextractors	73
<b>METZENBAUM</b> Dissecting scissors	15-16	<b>N</b>		Phlebodissector	73
<b>METZENBAUM SLIM</b>		<b>NABATOFF</b> Varicose vein probe set	72	<b>POTTS</b> Coarctation clamps	172
Dissecting scissors	19-21	Needle holders	82-97	<b>POTTS DEMARTEL</b> Vascular scissors	32
<b>MICRO 2000 (KOSHIMA)</b> Micro forceps	60	Needle holders HM	83-92	<b>POTTS GLOVER</b> Anastomosis clamp	175
<b>MICRO 2000</b> Micro forceps	60-63	Needle holders HM explanations	82	<b>POTTS GLOVER</b> Cardiovascular clamp	160
<b>MICRO 2000</b> Micro needle holders	95-97	Needle holders micro	91-97	<b>POTTS</b> Patent ductus clamps	170
<b>MICRO 2000</b> Micro scissors	34-36	<b>NELSON</b> Dissecting scissors	17-18	<b>POTTS SATINSKY</b> Anastomosis clamp	175
				<b>POTTS SATINSKY</b> Vena cava clamps	187
				<b>POTTS SMITH</b> Dressing forceps	45
				<b>POTTS SMITH</b> Tissue forceps	45
				<b>POTTS SMITH</b> Vascular scissors	26, 30
				<b>POTTS SMITH HM</b> Dressing forceps	42



<b>POTTS YASARGIL</b> Micro scissors	39	<b>SAUERBRUCH</b> Rib shears	260	<b>SMITH POTTS</b> Vascular scissors	26, 30
<b>PRICE THOMAS</b> Bronchus clamps	151	Scapular retractors	229	Spatulas lung	221-228
Punches aorta	304	<b>SCHMID</b> Vascular irrigation cannulas	76	Spreaders rib	264-295
<b>PYNCHON ANDREWS</b> Suction instrument	67	<b>SCHMID</b> Vascular spatulas	78	<b>STERNAL CASTANEDA</b>	
		<b>SCHOENBORN</b> Retractors	213	Rib and sternal retractors	283
<b>R</b>		<b>SCHWARTZ</b> Clip applying forceps	117	<b>STERNAL MEDICON MORSE</b>	
<b>RAGNELL (KILNER)</b> Dissecting scissors	13	<b>SCHWARTZ</b> Vessel clips	117	Rib and sternal retractors	270
Raspatories	242-246	Scissors	2-40	<b>STERNAL MORSE FAVALORO</b>	
Renal hemostatic clamps	181-182	Scissors black line	9-10, 12-21, 27-28	Rib and sternal retractors	269
Retractors	209-227	Scissors delicate	9-10	<b>STERNAL MORSE</b>	
Retractors aorta	229, 234	Scissors dissecting	12-21	Rib and sternal retractors	268
Retractors atrium	230-233	Scissors explanations	2-8	Sternal retractor	265-295
Retractors IMA	265-267	Scissors HM	9-10, 12-20, 27-29, 33	Sternum chisel	296
Retractors lung	229	Scissors ligature	40	<b>STEVENS</b> Delicate scissors	9
Retractors rib	264-295	Scissors lobectomy	22-23	<b>STILLE</b> Bone rongeur	249
Retractors scapular	229	Scissors magic cut	9-10, 12, 14-18, 20-21, 27-28, 31, 33	<b>STILLE LISTON</b>	
Retractors self-retaining	236-239	Scissors micro	33-39	Bone cutting forceps	254
<b>REYNOLDS (JAMESON)</b>		Scissors operating	11	<b>STILLE LUER</b> Bone rongeurs	248
Dissecting scissors	21	Scissors supercut	9-10, 12-21, 27-28, 30-31, 36-37	<b>STILLE SEMB</b> Bone rongeurs	249
Rib and sternal retractors	265-295	Scissors supercut plus	9-10, 12-20	<b>STRATTE HM</b> Needle holders	87
Rib contractors	264	Scissors tissue	23	<b>STRUCK</b> Rib and sternal retractor	275
Rib shears	258-261	Scissors undermining	10	<b>STRULLY</b> Vascular scissors	27
Rib spreaders	264-295	Scissors vascular	24-32	Subclavian Hemostatic clamp	165
<b>RIENHOFF FINOCHIETTO</b>		Scissors vein	39	<b>SUBRAMANIAN DEBAKEY AT</b>	
Rib and sternal retractor	281	Scissors wire cutting	100	Neonatal clamp	195
<b>ROCHESTER OCHSNER KOCHER</b>		<b>SELECT</b> Dressing forceps	44	<b>SUBRAMANIAN</b> Neonatal clamps	195
Hemostatic Forceps	136	<b>SELECT</b> Tissue forceps	44	Suction instruments	66-69
<b>ROCHESTER PEAN</b> Hemostatic forceps	134	Self-retaining retractors	236-239	<b>SUPERCUT PLUS</b> Scissors	9-10, 12-20
Rongeurs bone	247-251	<b>SELLORS CRAFOORD</b>		<b>SUPERCUT</b> Scissors	9-10, 12-21, 27-28, 30-31, 36-37
<b>ROSS</b> Aorta retractors	234	Hemostatic forceps	137	Suture forceps	61, 63
<b>RUMEL BELMONT</b> Tourniquets	298	<b>SELLORS</b> Rib spreader	264	Suture tying forceps micro	64
<b>RUSKIN LISTON</b>		<b>SEMB</b> Bone holding forceps	257	<b>SWEET LAHEY</b>	
Bone cutting forceps	253	<b>SEMB</b> DEBAKEY AT ligature clamp	185	Dissecting and ligature forceps	148
<b>RYDER (FRENCH EYE) HM</b>		<b>SEMB</b> Dissecting and ligature forceps	150	<b>SYPERT</b> Bone rongeur	251
Needle holders	85	<b>SEMB</b> Lung retractors	229		
<b>RYDER MATHIEU MICRO HM</b>		<b>SEMB</b> Raspatories	243	<b>T</b>	
Needle holders	90	<b>SEMB STILLE</b> Bone rongeurs	249	Tangential occlusion clamps	168
<b>RYDER MINI HM</b> Needle holders	85	<b>SEMKEN</b> Tissue forceps	44	<b>THOMAS PRICE</b> Bronchus clamps	151
<b>RYDER SLIM HM</b> Needle holders	86	<b>SENNING HM</b> Needle holders	88	Tissue forceps	43-46
		<b>SENNING</b> Needle holder	88	Tissue grasping forceps	56-57, 200-204
		Set suggestions	308-318	Tissue grasping forceps HM	200, 203
<b>S</b>		<b>SHEA</b> Dissecting scissors	12	Tissue scissors	23
<b>SACHS</b> Vascular spatula	78	Shears rib	258-261	Titanium Hemostatic forceps	130-131
<b>SAROT</b> Hemostatic forceps	137	<b>SIEGERT</b> Delicate scissors	10	Titanium bulldog clamps	120-121
<b>SAROT</b> Bronchus clamps	152	<b>SKILLMAN MEDICON PACKER</b>		Titanium forceps	120-121, 130-131
<b>SAROT HM</b> Needle holders	84	Hemostatic forceps	130	Titanium forceps atraumatic	53-55
<b>SATINSKY BABY</b> Vena cava clamp	186	<b>SLIM</b> Dissecting scissors	14	Titanium micro forceps	58
<b>SATINSKY DEBAKEY AT</b>		<b>SLIM METZENBAUM</b>		Titanium micro forceps	94
Vena cava clamps	187	Dissecting scissors	19-21	Titanium micro needle holders	38
<b>SATINSKY POTTS</b>		<b>SLIM MICRO HM</b> Needle holders	85	Titanium micro scissors	106
Anastomosis clamp	175	<b>SLIM OVERHOLT</b>		Titanium vessel clips	106
<b>SATINSKY POTTS</b>		Dissecting and ligature forceps	144	<b>TOENNIS HM</b> Needle Holders	90
Vena cava clamps	187	<b>SLIM RYDER HM</b> Needle holders	86	<b>TOENNIS</b> Vascular spatulas	79
<b>SATINSKY</b> Vascular scissors	24, 26	<b>SMITH PETERSEN</b> Bone rongeurs	248	Tourniquets	298
<b>SATINSKY</b> Vena cava clamps	186	<b>SMITH POTTS</b> Dressing forceps	45	Tray for instruments	320
<b>SAUERBRUCH</b> Retractor	217	<b>SMITH POTTS HM</b> Dressing forceps	42	<b>TUBBS</b> Aorta dilator	299
		<b>SMITH POTTS</b> Tissue forceps	45	<b>TUFFIER</b> Rib and sternal retractors	288





## Alphabetical Index, Page

Tunneling set	302-303	Wire cutting pliers HM	100-101
<b>TUTTLE</b> Tissue grasping forceps	56	Wire instruments	100-104
<b>U</b>			
<b>ULTRA</b> Hemostatic forceps	129	Wire twisting forceps	102-104
Undermining scissors	10	<b>WOOD CRILE HM</b> Needle holders	84
<b>UNIVERSAL HM</b>		Wound retractors	209-227
Wire cutting scissors	100	<b>WYLIE AT</b> Abdominal aorta clamps	164
<b>UNIVERSAL</b> Wire cutting scissors	100	<b>Y</b>	
<b>UNIVERSAL</b> Wire twisting forceps	103	<b>YANKAUER</b> Suction instruments	66-67
<b>V</b>			
Valvulotomes	305	<b>YASARGIL</b> Micro needle holders	95, 97
<b>VARADY</b> Phleboextractors	73	<b>YASARGIL</b> Micro scissors	34, 39
<b>VARADY</b> Phlebodissector	73	<b>YASARGIL POTTS</b> Micro scissors	39
Varicose vein instruments	72-74	<b>Z</b>	
Varicose vein probe sets	72-73	<b>ZANGER AT</b> Abdominal aorta clamps	165
Vascular dilators	298	<b>ZENKER</b> Retractors	217
Vascular forceps	48-55		
Vascular irrigation cannulas	76		
Vascular scissors	24-32		
Vascular spatulas	78-80		
Vein hooks	206		
Vein instruments	73		
Vein retractors	209, 212		
Vein scissors	39		
Vein stripper	74		
Vena cava clamps	186-188		
<b>VERNET GIL</b> Wound and vessel retractors	211		
Vessel clips	106-109, 111-117		
Vessel clips micro	107-109, 111-115		
Vessel clips titanium	106		
Vessel hooks	206-212		
Vessel spreader	117		
<b>W</b>			
<b>WANGENSTEEN HM</b> Needle holder	89		
<b>WANGENSTEEN HM</b>			
Tissue grasping forceps	57		
<b>WANGENSTEEN</b>			
Tissue grasping forceps	57		
<b>WEBER AT</b> Aorta clamps	190		
<b>WEITLANER BECKMANN</b>			
Self-retaining retractors	238		
<b>WEITLANER</b> Self-retaining retractors	236-237		
<b>WERTHEIM BOZEMANN HM</b>			
Needle holders	87		
<b>WIKSTROEM</b>			
Dissecting and ligature forceps	146		
<b>WILLAUER</b> Lobectomy scissors	22		
<b>WILLIAMS</b> Tissue grasping forceps	202		
Wire cutters	100		
Wire cutting pliers	100-101		



<b>A</b>			<b>B</b>			<b>C</b>		
Accesorios	320-321		<b>BABY HAIGHT</b>			Cánulas para lavado vascular		76
Aceite para el mantenimiento de instrumentos	321		Separadores para costillas y esternón	281		<b>CASTANEDA AT NEONATAL</b>		
<b>ACLAND</b> Aproximadores	108-109		<b>BABY HARRINGTON</b>			Pinzas para recién nacidos		196
<b>ACLAND</b> Micro clips vasculares	107-109		Separador y espátula para pulmones	221		<b>CASTANEDA STERNAL</b>		
<b>ACLAND</b> Pinzas para aplicar clips	110		<b>BABY KOCHER</b> Pinzas hemostáticas	128		Separadores para costillas y esternón		283
<b>ADSON BABY</b>			<b>BABY METZENBAUM</b>			<b>CASTROVIEJO (KOSHIMA)</b>		
Pinzas para preparación y para ligadura	145		Tijeras para preparación	14		Micro porta-agujas		91
<b>ADSON BECKMANN</b>			<b>BABY MIXTER</b>			<b>CASTROVIEJO HM</b> Micro porta-agujas		91
Separadores autoestáticos	239		Pinzas para preparación y para ligadura	145		<b>CASTROVIEJO MICRO</b> Micro porta-agujas		91
<b>ADSON BROWN</b> Pinzas quirúrgicas	43		<b>BABY PEAN</b> Pinzas hemostáticas	128		<b>CASTROVIEJO MICRO</b> porta-agujas		91
<b>ADSON GRAEFE</b> Pinza quirúrgica	43		<b>BABY SATINSKY</b> Pinza de vena cava	186		Cinzel esternal		296
<b>ADSON HALSTED</b> Pinzas hemostáticas	138		<b>BAILEY GIBBON</b>			Clips vasculares	106-109, 111-117	
<b>ADSON HM</b> Pinza anatómica	43		Separador para costillas	264		Clips vasculares de titanio		106
<b>ADSON HM</b> Pinza quirúrgica	43		<b>BAILEY</b> Perforadora para aorta	304		Clips vasculares micro	107-109, 111-115	
<b>ADSON JACOBSON (KOSHIMA)</b>			<b>BAILEY</b> Separador para costillas	264		<b>COLLIN CORYLLOS BETHUNE</b>		
Micro Pinza	60		<b>BAINBRIDGE DEBAKEY AT</b>			Costótomos		258
<b>ADSON JACOBSON</b> Micro Pinza	59		Pinzas hemostáticas	132		<b>COLLIN DUVAL</b>		
<b>ADSON MICRO</b> Pinza anatómica	43		Bandeja de plástico	320		Pinzas para agarrar tejidos		56
<b>ADSON MICRO</b> Pinza quirúrgica	43		<b>BARRAQUER</b> Micro porta-agujas	92		<b>COLLIN</b> Pinza para agarrar tejidos		200
<b>ADSON</b> Pinzas hemostáticas	138		<b>BAUMGARTNER HM</b> Porta-aguja	83		<b>COOLEY AT</b> Pinza para anastomosis		175
<b>ADSON</b> Separador autoestático	239		<b>BECK DEBAKEY AT</b>			<b>COOLEY AT</b> Pinzas de conducto arterial		170
Alambres para huesos	104		Pinzas de vena cava	188		<b>COOLEY AT</b> Pinzas para arteria renal		181
<b>ALEXANDER FARABEUF</b> Legra	244		<b>BECKMANN ADSON</b>			<b>COOLEY AT</b> Pinzas para coarctación		172
Alicates	100-101		Separadores autoestáticos	239		<b>COOLEY AT</b> Pinzas para iliaca		169
Alicates HM	100-101		<b>BECKMANN EATON</b>			<b>COOLEY AT</b> Pinzas para los bronquios		154
Alicates de pico plano	103		Separador autoestático	238		<b>COOLEY AT</b> Pinzas para recién nacidos		192-194
<b>ALLEN KOCHER</b> Pinzas hemostáticas	132		<b>BECKMANN</b> Separador autoestático			<b>COOLEY AT</b> Pinzas vasculares		156-159
<b>ALLIS AT</b> Pinzas para agarrar tejidos	202		<b>BECKMANN WEITLANER</b>			<b>COOLEY DERRA AT</b>		
<b>ALLISON</b> Espátulas para pulmones	228		Separadores autoestáticos	298		Pinza para anastomosis		174
<b>ALM</b> Separadores autoestáticos	236		<b>BELMONT RUMEL</b> Tourniquetes			<b>COOLEY</b> Dilatador para la aorta		299
<b>ANDREWS PYNCHON</b>			<b>BENGOLEA</b> Pinzas hemostáticas	141		<b>COOLEY GLOVER AT</b>		
Instrumento de aspiración	67		<b>BETHUNE CORYLLOS (COLLIN)</b>			Pinza para anastomosis		175
<b>ANKENEY MEDICON</b>			Costótomos	258		<b>COOLEY GLOVER AT</b> Pinza vascular		159
Separadores para costillas y esternón	277-278		<b>BETHUNE</b> Costótomo	259		<b>COOLEY</b> Instrumento de aspiración		68
Aproximador para nervios	112		<b>BIEMER</b> Aproximador	111-112		<b>COOLEY</b> Pinzas para catéteres		197
Aproximadores	108-109, 111-114		<b>BIEMER</b> Aproximador para nervios	112		<b>COOLEY</b> Separadores para atrium		230-233
<b>AUSTIN</b> Micro Pinza para enlazar	64		<b>BIEMER</b> Micro clips vasculares	111		<b>COOLEY</b>		
			<b>BIEMER</b> Muellers Aproximadores	113		Separadores para costillas y esternón		286, 289-295
			<b>BIEMER MUELLER</b>			<b>CORWIN HEGAR</b>		
			Micro clips vasculares	113		Pinza-tensora de alambre		104
			<b>BIEMER</b> Pinzas para aplicar clips	111, 113-114		<b>CORYLLOS BETHUNE (COLLIN)</b>		
			<b>BIEMER</b> Separador para vasos	117		Costótomos		258
			<b>BIEMER</b> Tijera para venas	39		<b>CORYLLOS</b> Separadores		218
			<b>BLACK LINE</b> Tijeras	9-10, 12-21, 27-28		Costótomos		258-261
			<b>BLANK</b> Pinzas anatómicas	42		<b>CRAFOORD MIXTER</b>		
			<b>BOYD</b> Tijera vascular	25		Pinzas para preparación y para ligadura		148
			<b>BOZEMANN (WERTHEIM) HM</b>			<b>CRAFOORD SELLORS</b>		
			Porta-agujas	87		Pinzas hemostáticas		137
			<b>BRIDGE</b> Pinzas hemostáticas	140		<b>CRAFOORD</b> Tijera pulmonar		22
			<b>BROPHY</b> Pinzas anatómicas	45		<b>CRAWFORD</b> Separadores para aorta		229
			<b>BROPHY</b> Pinzas quirúrgicas	45		<b>CRILE BABY</b> Pinzas hemostáticas		128
			<b>BROWN ADSON</b> Pinzas quirúrgicas	43		<b>CRILE</b> Pinzas hemostáticas		131
			<b>BROWN</b> Pinzas para agarrar tejidos	57		<b>CRILE WOOD BABY HM</b> Porta-aguja		83
			<b>BRUNNER</b> Costótomos	261		<b>CRILE WOOD HM</b> Porta-agujas		84
			Bulldog pinzas	120-127, 155		<b>CUSHING</b> Ganchitos para nervios		206
			Bulldog pinzas atraumáticas	120-121, 125-127		<b>CUSHING</b> Ganchos para vasos		206
			<b>BURFORD</b>					
			Separadores para costillas y esternón	271-273				

<b>CUSHING</b> Ganchos para venas	209, 212	<b>DEBAKEY SEMB AT</b> Pinza para ligadura	185	<b>FINOCHIETTO INFANT</b>	
<b>CUSHING HM</b> Pinzas anatómicas	46	<b>DEBAKEY</b>		Separadores para costillas y esternón	279
<b>CUSHING</b> Legras	242	Separadores para costillas y esternón	274	<b>FINOCHIETTO MEDICON</b>	
<b>CUSHING</b> Pinza anatómica	46	<b>DEBAKEY</b> Tijeras vasculares	26, 29, 32	Separador para costillas y esternón	280
<b>CUSHING</b> Pinza quirúrgica	46	<b>DEBOER</b>		<b>FINOCHIETTO</b>	
		Separador para costillas y esternón	287	Pinza para preparaciones y para ligaduras	150
<b>D</b>		<b>DEMARTEL POTTS</b> Tijera vascular	32	<b>FINOCHIETTO RIENHOFF</b>	
<b>DALE AT</b> Pinzas para vasos periféricos	179	<b>DEMARTEL</b> Tijeras vasculares	25	Separador para costillas y esternón	281
<b>DARDIK AT</b> Pinzas vasculares	161	<b>DERRA COOLEY AT</b>		<b>FINOCHIETTO</b>	
<b>DAVIDSON</b> Espátulas para scapula	229	Pinzas para anastomosis	174	Separadores para costillas	
<b>DAVIS</b> Espátulas vasculares	78-79	<b>DERRA DEBAKEY AT</b>		y esternón	280, 282, 285
<b>DEAVER BABY</b>		Pinzas para anastomosis	174	<b>FINOCHIETTO</b> Tijera pulmonar	23
Separadores y espátulas para pulmones	222	<b>DESMARRES</b>		<b>FINSTERER</b>	
<b>DEAVER</b>		Separadores y ganchos para vasos	209	Tubo de aspiración y de lavado	69
Separadores y espátulas para pulmones	223-226	<b>DIEFFENBACH</b> Pinzas Bulldog	123	<b>FISCH</b> Ganchos finos	208
<b>DEBAKEY AT HUSFELDT</b>		<b>DIETHRICH GREGORY</b> Tijera vascular	32	Fleboextractores	73
Pinzas para carótida	166-167	<b>DIETHRICH HEGEMANN</b>		Flebodisector	73
<b>DEBAKEY AT</b> Pinzas atraumáticas	48-55	Tijeras vasculares	31	<b>FREEMAN GORNEY</b> Tijeras vasculares	28
<b>DEBAKEY AT</b>		<b>DIETHRICH</b> Pinzas Bulldog	122	<b>FRENCH EYE RYDER HM</b> Porta-agujas	85
Pinzas atraumáticas de titanio	53-55	Dilatadores	298-299	<b>FUCHSIG</b> Pinza hemostática	142
<b>DEBAKEY AT</b> Pinzas Bulldog	125-126	Dilatadores para la aorta	299		
<b>DEBAKEY AT</b> Pinzas de conducto arterial	171	Dilatadores vasculares	298		
<b>DEBAKEY AT</b> Pinzas hemostáticas	132	<b>DINGMANN</b> Pinzas para de huesos	256		
<b>DEBAKEY AT</b> Pinzas para agarrar tejidos	201	Disectores de endoarteriotomía	75	<b>G</b>	
<b>DEBAKEY AT</b>		<b>DIXON LOVELACE</b> Pinzas hemostáticas	133	Ganchitos para nervios	206
Pinzas para aneurisma de aorta	183-184	<b>DOYEN</b> Legras	245	Ganchitos para venas	206
<b>DEBAKEY AT</b> Pinzas para aorta	189	<b>DUBOST</b>		Ganchos finos	207-208
<b>DEBAKEY AT</b> Pinzas para coarctación	173	Separador para costillas y esternón	276	Ganchos para vasos	206-212
<b>DEBAKEY AT</b> Pinzas para ligadura	184-185	<b>DUVAL AT</b> Pinza para agarrar tejidos	201	Ganchos para venas	209, 212
<b>DEBAKEY AT</b>		<b>DUVAL COLLIN</b>		<b>GEISSENDOERFER OVERHOLT</b>	
Pinzas para multiples aplicaciones	156-163	Pinzas para agarrar tejidos	56	Pinzas para preparación y para ligadura	143
<b>DEBAKEY AT</b>		<b>DUVAL HM</b> Pinzas para agarrar tejidos	200	<b>GEMINI</b>	
Pinzas para oclusión tangencial	168	<b>DUVAL</b> Pinzas para agarrar tejidos	56, 200	Pinzas para preparación y para ligadura	147
<b>DEBAKEY AT</b>				<b>GIBBON BAILEY</b> Separador para costillas	264
Pinzas para vasos periféricos	177-178, 180	<b>E</b>		<b>GIERTZ</b> Costótomo	260
<b>DEBAKEY AT</b> Pinzas vasculares	155-156, 162-163	<b>EASY CUT HM</b> Pinza para cortar alambres	101	<b>GIL VERNET</b>	
<b>DEBAKEY AT SUBRAMANIAN</b>		<b>EATON BECKMANN</b>		Separadores y ganchos para vasos	211
Pinza para recién nacidos	195	Separador autoestático	239	<b>GILLIES</b> Ganchos para vasos	207
<b>DEBAKEY BAINBRIDGE AT</b>		<b>ECHLIN</b> Pinzas-gubias	251	<b>GILLIES</b> Pinza quirúrgica	45
Pinzas hemostáticas	132	<b>ELF</b> Gancho fino	208	<b>GLOVER AT</b> Pinzas Bulldog	126
<b>DEBAKEY BECK AT</b> Pinzas de vena cava	188	Espátulas para pulmones	221-229	<b>GLOVER COOLEY AT</b>	
<b>DEBAKEY DERRA AT</b>		Espátulas para scapula	229	Pinza para anastomosis	175
Pinzas para anastomosis	174	Espátulas vasculares	78-80	<b>GLOVER COOLEY AT</b> Pinza vascular	159
<b>DEBAKEY</b> Dilatadores vasculares	298	<b>EUFRATE PASQUÉ HM</b> Porta-agujas	86	<b>GLOVER DEBAKEY AT</b>	
<b>DEBAKEY GLOVER AT</b> Pinza para aurícula	169	Extractores de venas	74	Pinza para aurícula	169
<b>DEBAKEY GLOVER AT</b>				<b>GLOVER DEBAKEY AT</b>	
Pinzas para anastomosis	176	<b>F</b>		Pinzas para anastomosis	176
<b>DEBAKEY GLOVER AT</b> Pinzas vasculares	159-160	<b>FARABEUF ALEXANDER</b> Legra	244	<b>GLOVER DEBAKEY AT</b>	
<b>DEBAKEY HARKEN AT</b>		<b>FAVALORO MORSE STERNAL</b>		Pinzas vasculares	159-160
Pinzas de vena cava	188	Separadores para costillas y esternón	269	<b>GLOVER POTTS</b> Pinza para anastomosis	175
<b>DEBAKEY HM</b> Porta-agujas	84	<b>FAVALORO</b> Tijera vascular	32	<b>GLOVER POTTS</b> Pinza vascular	160
<b>DEBAKEY HM</b> Tijera vascular	29	<b>FAVALORO</b> Pinza para de huesos	257	<b>GLUCK</b> Costótomo	259
<b>DEBAKEY</b> Instrumentos de aspiración	67, 69	<b>FINOCHIETTO BABY HAIGHT</b>		<b>GORNEY FREEMAN</b> Tijeras vasculares	28
<b>DEBAKEY PEAN AT</b> Pinzas hemostáticas	135	Separadores para costillas y esternón	279	<b>GORNEY</b> Tijeras vasculares	27
<b>DEBAKEY SATINSKY AT</b>		<b>FINOCHIETTO HM</b> Porta-aguja	89	<b>GRAEFE ADSON</b> Pinza quirúrgica	43
Pinzas de vena cava	187			<b>GREENBERG PAR</b> Tijeras para preparación	12



<b>H</b>		
<b>HAIGHT BABY</b>		
Separadores para costillas y esternón	281	
<b>HAIGHT FINOCHIETTO BABY</b>		
Separadores para costillas y esternón	279	
<b>HAIMOVICI</b> Tijeras vasculares	25	
<b>HALLE</b> Espátula vascular	80	
<b>HALSEY HM</b> Porta-aguja	83	
<b>HALSTED (ADSON)</b> Pinzas hemostáticas	138	
<b>HALSTED MICRO</b> Pinzas hemostáticas	128	
<b>HALSTED MOSQUITO</b>		
Pinzas hemostáticas	130	
<b>HARKEN DEBAKEY AT</b>		
Pinzas de vena cava	188	
<b>HARKEN NISSEN</b>		
Separador para costillas y esternón	284	
<b>HARRINGTON BABY</b>		
Separador y espátula para pulmones	221	
<b>HARRINGTON PEMBERTON</b>		
Separador y espátula para pulmones	222	
<b>HARRINGTON</b>		
Separadores y espátulas para pulmones	221	
<b>HEANEY HM</b> Porta-aguja	87	
<b>HEGAR CORWIN</b>		
Pinza-tensora de alambre	104	
<b>HEGAR MAYO HM</b> Porta-agujas	83	
<b>HEGEMANN DIETRICH</b>		
Tijeras vasculares	31	
<b>HEISS</b> Pinzas hemostáticas	139, 142	
<b>HENLY AT</b> Pinza para arteria subclaviana	165	
<b>HM</b> Tijeras	9-10, 12-20, 27-29, 33	
<b>HOEPFNER</b> Pinza vascular	159	
<b>HOPKINS JOHNS</b> Pinzas Bulldog	124	
<b>HOPT AT</b> Pinzas para arteria renal	182	
<b>HUSFELDT DEBAKEY AT</b>		
Pinzas para carótida	166-167	
<b>I</b>		
<b>IMA</b> Separadores	265-267	
<b>INFANT FINOCHIETTO</b>		
Separadores para costillas y esternón	279	
Instrumentos de aspiración	66-69	
Instrumentos para alambre	100-104	
Instrumentos para endarterectomía	75	
Instrumentos para varices	72-74	
Instrumentos para vena	73	
<b>INTRACARDIAC HM</b> Porta-agujas	85	
<b>J</b>		
<b>JACOBSON ADSON (KOSHIMA)</b>		
Micro Pinza	60	
<b>JACOBSON ADSON</b> Micro Pinza	59	
<b>JACOBSON</b> Gancho fino	208	
<b>JACOBSON HM</b> Micro porta-agujas	92	
<b>JACOBSON MICRO (KOSHIMA)</b>		
Pinzas hemostáticas	129	
<b>JACOBSON MICRO 2000</b> Tijeras micro	35	
<b>JACOBSON</b> Micro Pinzas	59	
<b>JACOBSON MICRO</b> Pinzas hemostáticas	138	
<b>JACOBSON</b> Micro porta-agujas	92	
<b>JACOBSON</b> Tijera micro	39	
<b>JAMESON REYNOLDS</b>		
Tijeras para preparaciones	21	
<b>JAVID</b> Pinzas para carótida	167	
<b>JOHNS HOPKINS</b> Pinzas Bulldog	124	
<b>JONES LELAND AT</b>		
Pinzas para vasos periféricos	177	
Juego de tunelización	302-303	
Juegos para varices	72-73	
<b>JULIAN HM</b> Porta-agujas	84	
<b>K</b>		
<b>KADER</b>		
Separadores y espátulas para pulmones	227	
<b>KAY LAMBERT AT</b> Pinza para aorta	191	
<b>KELLY</b> Separador	219	
<b>KELLY</b> Tijeras finas	10	
<b>KEY LISTON</b> Pinza cortante para huesos	254	
<b>KILNER RAGNELL</b>		
Tijeras para preparaciones	13	
<b>KLINKENBERGH</b> Tijera vascular	24	
<b>KOCHER ALLEN</b> Pinzas hemostáticas	132	
<b>KOCHER BABY</b> Pinzas hemostáticas	128	
<b>KOCHER LANGENBECK</b> Separadores	216	
<b>KOCHER</b> Pinzas hemostáticas	133	
<b>KOCHER ROCHESTER OCHSNER</b>		
Pinzas hemostáticas	136	
<b>KOENIG</b>		
Separadores y ganchos para vasos	209	
<b>KOSHIMA CASTROVIEJO</b>		
Micro porta-agujas	91	
<b>KOSHIMA JACOBSON ADSON</b>		
Micro Pinza	60	
<b>KOSHIMA MICRO JACOBSON</b>		
Pinzas hemostáticas	129	
<b>KOSHIMA</b> Micro Pinzas	60	
<b>KOSHIMA</b> Tijeras micro	35	
<b>KRAYENBUEHL</b> Ganchos para vasos	207	
<b>L</b>		
<b>LAHEY</b>		
Pinzas para preparación y para ligadura	145, 147	
<b>LAHEY</b> Separadores	213	
<b>LAHEY SWEET</b>		
Pinza para preparación y para ligaduras	148	
<b>LAMBERT KAY AT</b> Pinza para aorta	191	
<b>LAMBOTTE</b> Legras	242	
<b>LANGENBECK HM</b> Porta-agujas	90	
<b>LANGENBECK KOCHER</b> Separadores	216	
<b>LANGENBECK</b> Legra	242	
<b>LANGENBECK</b> Pinza para de huesos	257	
<b>LANGENBECK</b> Separadores	213-215	
<b>LEBSCHKE</b> Cíncel esternal	296	
<b>LEES AT</b>		
Pinzas para los bronquios	153	
Legras	242-246	
<b>LEKSELL</b> Pinzas-gubias	250	
<b>LELAND JONES AT</b>		
Pinzas para vasos periféricos	177	
<b>LEMMON</b> Espátulas vasculares	78	
<b>LEMOLE AT</b> Pinzas para aorta	166	
<b>LERICHE</b> Pinzas hemostáticas	131	
<b>LICHTENBERG HM</b> Porta-agujas	90	
<b>LISTON KEY</b> Pinza cortante para huesos	254	
<b>LISTON</b> Pinzas cortantes para huesos	252	
<b>LISTON RUSKIN</b>		
Pinzas cortantes para huesos	253	
<b>LISTON STILLE</b>		
Pinzas cortantes para huesos	254	
<b>LITTAUER</b> Pinza cortante para huesos	253	
<b>LOCKLIN</b> Tijera para tejidos	23	
<b>LOVE (MORSE)</b>		
Separadores y ganchos para vasos	212	
<b>LOVELACE DIXON</b> Pinza hemostática	133	
<b>LOVELACE</b> Pinza hemostática	133	
<b>LUCAE</b> Ganchos para vasos	206	
<b>LUER STILLE</b> Pinzas-gubias	248	
<b>M</b>		
<b>MAGIC CUT</b> Tijeras	9-10, 12, 14-18, 20-21, 27-28, 31, 33	
<b>MARBERGER</b>		
Separadores y ganchos para vasos	210	
<b>MASSON HM</b> Porta-aguja	88	
<b>MATHIEU HM</b> Porta-agujas	90	
<b>MATHIEU RYDER MICRO HM</b>		
Porta-agujas	90	
<b>MATSON</b> Legra	244	
<b>MAYO HEGAR HM</b> Porta-agujas	83	
<b>MAYO</b> Instrumentos para varices	74	
<b>MAYO</b> Pinza para agarrar tejidos	57	
<b>MCINDOE</b> Pinza anatómica	45	
<b>MCINDOE</b> Pinzas cortantes para huesos	253	
<b>MEDICON ANKENEY</b>		
Separadores para costillas y esternón	277-278	
<b>MEDICON FINOCHIETTO</b>		
Separador para costillas y esternón	280	
<b>MEDICON HM</b> Pinza-tensora de alambre	102	
<b>MEDICON IMA</b> Separadores	266-267	
<b>MEDICON MORSE STERNAL</b>		
Separadores para costillas y esternón	270	
<b>MEDICON PACKER (SKILLMAN)</b>		
Pinzas hemostáticas	130	
<b>MEDICON</b> Pinza-tensora de alambre	102	
<b>MEDICON</b> Separador para costillas	264	
<b>MEDICON</b> Separadores autoestáticos	236	

<b>MEEKER</b> Pinza hemostática	140
<b>MEHDORN</b> Micro clips vasculares	115
<b>MERZ</b> Perforadora para aorta	304
<b>METZENBAUM BABY</b> Tijeras para preparación	14
<b>METZENBAUM SLIM</b> Tijeras para preparación	19-21
<b>METZENBAUM</b> Tijeras para preparación	15-16
<b>MICRO 2000 (KOSHIMA)</b> Micro pinza	60
<b>MICRO 2000</b> Micro pinzas	60-63
<b>MICRO 2000</b> Micro porta-agujas	95-97
<b>MICRO 2000</b> Micro tijeras	34-36
<b>MICRO ADSON</b> Pinza anatómica	43
<b>MICRO ADSON</b> Pinza quirúrgica	43
<b>MICRO CASTROVIEJO</b> Micro porta-agujas	91
Micro clips vasculares	107-109, 111-115
<b>MICRO HALSTED</b> Pinzas hemostáticas	128
<b>MICRO JACOBSON (KOSHIMA)</b> Pinzas hemostáticas	129
<b>MICRO JACOBSON</b> Pinzas hemostáticas	138
Micro pinzas	58-64
Micro pinzas de titanio	58
Micro pinzas para enlazar	64
Micro porta-agujas	91-97
Micro porta-agujas de titanio	94
<b>MICRO SLIM HM</b> Porta-agujas	85
Micro tijeras	33-39
<b>MICROVASCULAR HM</b> Porta-agujas	86
<b>MIKULICZ</b> Separadores	219-220
<b>MILLES</b> Tijeras micro	39
<b>MILLS</b> Tijera vascular	32
<b>MINI RYDER HM</b> Porta-agujas	85
<b>MIOTTI OVERHOLT</b> Pinzas para preparación y para ligadura	144
<b>MIXTER BABY</b> Pinzas para preparación y para ligadura	145
<b>MIXTER CRAFOORD</b> Pinzas para preparación y para ligadura	148
<b>MIXTER OVERHOLT</b> Pinza para preparación y para ligadura	146
<b>MIXTER</b> Pinzas para preparación y para ligadura	145, 149
<b>MOLDESTAD</b> Gancho para vasos	206
<b>MORSE FAVALORO STERNAL</b> Separadores para costillas y esternón	269
<b>MORSE LOVE</b> Separadores y ganchos para vasos	212
<b>MORSE MEDICON STERNAL</b> Separadores para costillas y esternón	270
<b>MORSE STERNAL</b> Separadores para costillas y esternón	268
<b>MOSQUITO AT</b> Pinzas hemostáticas	129
<b>MOSQUITO HALSTED</b> Pinzas hemostáticas	130
<b>MUELLER</b> Aproximadores	114
<b>MUELLER</b> Clips vasculares	116
<b>MUELLER</b> Micro clips vasculares	114
<b>MYERS</b> Instrumentos para varices	74

**N**

<b>NABATOFF</b> Juego para varices	72
<b>NELSON</b> Pinzas para agarrar tejidos	56
<b>NELSON</b> Tijeras para preparación	17-18
<b>NEONATAL AT</b> Pinzas para recién nacidos	192-193
<b>NEONATAL CASTANEDA AT</b> Pinzas para recién nacidos	196
<b>NIRO HM</b> Pinza-tensora de alambre	102
<b>NIRO</b> Pinza-tensora de alambre	102
<b>NISSEN HARKEN</b> Separador para costillas y esternón	284

**O**

<b>OBWEGESER</b> Alicates de pico plano	103
<b>OBWEGESER</b> Legras	246
<b>OCHSNER ROCHESTER KOCHER</b> Pinzas hemostáticas	136
<b>O'SHAUGNESSY</b> Pinza para preparación y para ligadura	146
<b>OVERHOLT GEISSENDOERFER</b> Pinzas para preparación y para ligadura	143
<b>OVERHOLT MIOTTI</b> Pinzas para preparación y para ligadura	144
<b>OVERHOLT MIXTER</b> Pinza para preparación y para ligadura	146
<b>OVERHOLT SLIM</b> Pinzas para preparación y para ligadura	144

**P**

<b>PACKER MEDICON (SKILLMAN)</b> Pinzas hemostáticas	130
<b>PEAN AT</b> Pinzas hemostáticas	135
<b>PEAN BABY</b> Pinzas hemostáticas	128
<b>PEAN DEBAKEY AT</b> Pinzas hemostáticas	135
<b>PEAN</b> Pinzas hemostáticas	133
<b>PEAN ROCHESTER</b> Pinzas hemostáticas	134
<b>PEMBERTON HARRINGTON</b> Separador y espátula para pulmones	222
Perforadoras para aorta	304
<b>PERWIZSCHKY</b> Tijera vascular	24
<b>PETERSEN SMITH</b> Pinzas-gubias	248
Pinza para arteria subclaviana	165
Pinza para aurícula	169
Pinza para ligadura	116
Pinza para poner los clamps Bulldog	125
Pinzas	42-64, 120-197
Pinzas anatómicas	42-46
Pinzas atraumáticas	47-55, 120-121, 125-127, 129, 132, 135, 153-185, 187-196
Pinzas atraumáticas de titanio	53-55
Pinzas Bulldog	120-127, 155
Pinzas Bulldog atraumáticas	120-121, 125-127

Pinzas Bulldog de titanio	120-121
Pinzas cortantes para huesos	252-254
Pinzas de conducto arterial	170-171
Pinzas de titanio	120-121, 130-131
Pinzas de vena cava	186-188
Pinzas finas	43-45
Pinzas hemostáticas	128-142
Pinzas hemostáticas de titanio	130-131
Pinzas micro	58-64
Pinzas para agarrar	200-204
Pinzas para agarrar tejidos	56-57, 200-204
Pinzas para agarrar tejidos HM	200, 203
Pinzas para anastomosis	174-176
Pinzas para aneurisma de aorta	183-184
Pinzas para aorta	166, 189-191
Pinzas para aorta abdominal	164-165
Pinzas para aplicar clips	106, 110-111, 113-115, 117
Pinzas para aplicar clips para clips de titanio	106
Pinzas para arteria renal	181-182
Pinzas para carótida	166-167
Pinzas para catéteres	197
Pinzas para coarctación	172-173
Pinzas para enlazar	64
Pinzas para iliaca	169
Pinzas para ligadura	143-150, 184-185
Pinzas para los bronquios	156-163
Pinzas para multiples aplicaciones	151-154
Pinzas para oclusión tangencial	168
Pinzas para preparación	143-150
Pinzas para recién nacidos	192-196
Pinzas para sutura	61, 63-64
Pinzas para vasos periféricos	177-180
Pinzas para de huesos	256-257
Pinzas quirúrgicas	43-46
Pinzas vasculares	48-55, 155-197
Pinzas-gubias	247-251
Pinzas-tensoras de alambre	102-104
Porta-agujas	82-97
Porta-agujas HM	83-92
Porta-agujas HM explicaciones	82
Porta-agujas micro	91-97
<b>POTTS DEMARTEL</b> Tijera vascular	32
<b>POTTS GLOVER</b> Pinza para anastomosis	175
<b>POTTS GLOVER</b> Pinza vascular	160
<b>POTTS</b> Pinzas de conducto arterial	170
<b>POTTS</b> Pinzas para coarctación	172
<b>POTTS SATINSKY</b> Pinza para anastomosis	175
<b>POTTS SATINSKY</b> Pinzas de vena cava	187
<b>POTTS SMITH HM</b> Pinzas anatómicas	42
<b>POTTS SMITH</b> Pinzas anatómicas	45
<b>POTTS SMITH</b> Pinzas quirúrgicas	45
<b>POTTS SMITH</b> Tijeras vasculares	26, 30
<b>POTTS YASARGIL</b> Tijera micro	39



<b>PRICE THOMAS</b>		<b>SEMB DEBAKEY AT</b>		<b>SUPERCUT PLUS</b> Tijeras	9-10, 12-20
Pinzas para los bronquios	151	Pinza para ligadura	185	<b>SUPERCUT</b> Tijeras	9-10, 12-21, 27-28, 30-31, 36-37
Proposición de juegos	308-318	<b>SEMB</b> Espátulas para pulmones	229	<b>SWEET LAHEY</b>	
<b>PYNCHON ANDREWS</b>		<b>SEMB</b> Legras	243	Pinza para preparación y para ligadura	148
Instrumento de aspiración	67	<b>SEMB</b>		<b>SYPERT</b> Pinza-gubia	251
		Pinzas para preparación y para ligadura	150		
<b>R</b>		<b>SEMB</b> Pinzas para de huesos	257	<b>T</b>	
<b>RAGNELL (KILNER)</b>		<b>SEMB STILLE</b> Pinzas-gubias	249	<b>THOMAS PRICE</b> Pinzas para los bronquios	151
Tijeras para preparación	13	<b>SEMKEN</b> Pinzas quirúrgicas	44	Tijera para tejidos	23
<b>REYNOLDS (JAMESON)</b>		<b>SENNING HM</b> Porta-agujas	88	Tijera para venas	39
Tijeras para preparaciones	21	<b>SENNING</b> Porta-aguja	88	Tijeras	2-40
<b>RIENHOFF FINOCHIETTO</b>		Separador epicardiaco	236	Tijeras black line	9-10, 12-21, 27-28
Separador para costillas y esternón	281	Separador para vasos	117	Tijeras explicaciones	2-8
<b>ROCHESTER OCHSNER KOCHER</b>		Separadores	209-227	Tijeras finas	9-10
Pinzas hemostáticas	136	Separadores autoestáticos	236-239	Tijeras HM	9-10, 12-20, 27-29, 33
<b>ROCHESTER PEAN</b>		Separadores IMA	265-267	Tijeras magic cut	9-10, 12, 14-18, 20-21, 27-28, 31, 33
Pinzas hemostáticas	134	Separadores para aorta	229, 234	Tijeras micro	33-39
<b>ROOS</b> Separadores para aórta	234	Separadores para atrium	230-233	Tijeras micro de titanio	38
<b>RUMEL BELMONT</b> Tourniquetes	298	Separadores para costillas	264-295	Tijeras para cortar hilo de acero	100
<b>RUSKIN LISTON</b>		Separadores para costillas y esternón	265-295	Tijeras para ligaduras	40
Pinzas cortantes para huesos	253	Separadores para esternón	265-295	Tijeras para preparación	12-21
<b>RYDER (FRENCH EYE) HM</b>		<b>SHEA</b> Tijera para preparación	12	Tijeras para tunelización	10
Porta-agujas	85	<b>SIEGERT</b> Tijeras finas	10	Tijeras pulmonares	22-23
<b>RYDER MATHIEU MICRO HM</b>		<b>SKILLMAN MEDICON PACKER</b>		Tijeras quirúrgicas	11
Porta-agujas	90	Pinzas hemostáticas	130	Tijeras supercut	9-10, 12-21, 27-28, 30-31, 36-37
<b>RYDER MINI HM</b> Porta-agujas	85	<b>SLIM METZENBAUM</b>		Tijeras supercut plus	9-10, 12-20
<b>RYDER SLIM HM</b> Porta-agujas	86	Tijeras para preparaciones	19-21	Tijeras vasculares	24-32
		<b>SLIM MICRO HM</b> Porta-agujas	85	Titanio Bulldog pinzas	120-121
<b>S</b>		<b>SLIM OVERHOLT</b>		Titanio clips vasculares	106
<b>SACHS</b> Espátula vascular	78	Pinzas para preparación y para ligadura	144	Titanio micro pinzas	58
<b>SAROT HM</b> Porta-agujas	84	<b>SLIM RYDER HM</b> Porta-agujas	86	Titanio micro porta-agujas	94
<b>SAROT</b> Pinzas hemostáticas	137	<b>SLIM</b> Tijeras para preparaciones	14	Titanio pinzas	120-121, 130-131
<b>SAROT</b> Pinzas para los bronquios	152	<b>SMITH PETERSEN</b> Pinzas-gubias	248	Titanio pinzas atraumáticas	53-55
<b>SATINSKY BABY</b> Pinza de vena cava	186	<b>SMITH POTTS HM</b> Pinzas anatómicas	42	Titanio pinzas hemostáticas	130-131
<b>SATINSKY DEBAKEY AT</b>		<b>SMITH POTTS</b> Pinzas anatómicas	45	Titanio tijeras micro	38
Pinzas de vena cava	187	<b>SMITH POTTS</b> Pinzas quirúrgicas	45	<b>TOENNIS</b> Espátulas vasculares	79
<b>SATINSKY</b> Pinzas de vena cava	186	<b>SMITH POTTS</b> Tijeras vasculares	26, 30	<b>TOENNIS HM</b> Porta-agujas	90
<b>SATINSKY POTTS</b>		<b>STERNAL CASTANEDA</b>		Tourniquetes	298
Pinza para anastomosis	175	Separadores para costillas y esternón	283	<b>TUBBS</b> Dilatador para la aorta	299
<b>SATINSKY POTTS</b>		<b>STERNAL MEDICON MORSE</b>		Tabo de aspiración y de lavado	69
Pinzas de vena cava	187	Separadores para costillas y esternón	270	<b>TUFFIER</b>	
<b>SATINSKY</b> Pinzas de vena cava	186	<b>STERNAL MORSE FAVALORO</b>		Separadores para costillas y esternón	288
<b>SAUERBRUCH</b> Costótomo	260	Separadores para costillas y esternón	269	<b>TUTTLE</b> Pinzas para agarrar tejidos	56
<b>SAUERBRUCH</b> Separador	217	<b>STERNAL MORSE</b>			
<b>SCHMID</b>		Separadores para costillas y esternón	268	<b>U</b>	
Cánulas para lavado vascular	76	<b>STEVENS</b> Tijeras finas	9	<b>ULTRA</b> Pinzas hemostáticas	129
<b>SCHMID</b> Espátulas vasculares	78	<b>STILLE LISTON</b>		<b>UNIVERSAL HM</b>	
<b>SCHOENBORN</b> Separadores	213	Pinzas cortantes para huesos	254	Tijera para cortar hilo de acero	100
<b>SCHWARTZ</b> Clips vasculares	117	<b>STILLE LUER</b> Pinzas-gubias	248	<b>UNIVERSAL</b>	
<b>SCHWARTZ</b> Pinza aplicadora de clips	117	<b>STILLE</b> Pinza-gubia	249	Pinza-tensora de alambre	103
<b>SELECT</b> Pinzas anatómicas	44	<b>STILLE SEMB</b> Pinzas-gubias	249	<b>UNIVERSAL</b>	
<b>SELECT</b> Pinzas quirúrgicas	44	<b>STRATTE HM</b> Porta-agujas	87	Tijera para cortar hilo de acero	100
<b>SELLORS CRAFOORD</b>		<b>STRUCK</b>			
Pinzas hemostáticas	137	Separador para costillas y esternón	275		
<b>SELLORS</b> Separador para costillas	264	<b>STRULLY</b> Tijera vascular	27		
		<b>SUBRAMANIAN DEBAKEY AT</b>			
		Pinza para recién nacidos	195		
		<b>SUBRAMANIAN</b>			
		Pinzas para recién nacidos	195		



**V**

Valvulotomos	305
<b>VARADY</b> Fleboextractores	73
<b>VARADY</b> Flebodisector	73
<b>VERNET GIL</b>	
Separadores y ganchos para vasos	211

**W**

<b>WANGENSTEEN HM</b>	
Pinzas para agarrar tejidos	57
<b>WANGENSTEEN HM</b> Porta-aguja	89
<b>WANGENSTEEN</b>	
Pinzas para agarrar tejidos	57
<b>WEBER AT</b> Pinzas para aorta	190
<b>WEITLANER BECKMANN</b>	
Separadores autoestáticos	238
<b>WEITLANER</b>	
Separadores autoestáticos	236-237
<b>WERTHEIM BOZEMANN HM</b>	
Porta-agujas	87
<b>WIKSTROEM</b>	
Pinza para preparación y para ligadura	146
<b>WILLAUER</b> Tijera pulmonar	22
<b>WILLIAMS</b> Pinza para agarrar tejidos	202
<b>WOOD CRILE HM</b> Porta-agujas	84
<b>WYLIE AT</b> Pinzas para aorta abdominal	164

**Y**

<b>YANKAUER</b> Instrumentos de aspiración	66-67
<b>YASARGIL</b> Micro porta-agujas	95, 97
<b>YASARGIL POTTS</b> Tijera micro	39
<b>YASARGIL</b> Tijeras micro	34, 39

**Z**

<b>ZANGER AT</b> Pinzas para aorta abdominal	165
<b>ZENKER</b> Separadores	217





<b>CORYLLOS BETHUNE (COLLIN)</b>		<b>DEBAKEY AT SUBRAMANIAN</b>		<b>E</b>	
Costotomes	258	Pince pour nouveaux-nés	195	<b>EASY CUT HM</b> Pince coupe-fil	101
<b>CORYLLOS</b> Ecarteurs	218	<b>DEBAKEY BAINBRIDGE AT</b>		<b>EATON BECKMANN</b> Ecarteur autostatique	239
Costotomes	258-261	Pincés hémostatiques	132	Ecarteur épiscardic	236
<b>CRAFOORD</b> Ciseaux pulmonaires	22	<b>DEBAKEY BECK AT</b>		Ecarteur pour vaisseaux	117
<b>CRAFOORD MIXTER</b>		Pincés pour vena cava	188	Ecarteurs	209-227
Pincés à préparation et à ligature	148	<b>DEBAKEY</b> Ciseaux vasculaires	26, 29, 32	Ecarteurs à veines	209, 212
<b>CRAFOORD SELLORS</b>		<b>DEBAKEY DERRA AT</b>		Ecarteurs autostatiques	236-239
Pincés hémostatiques	137	Pincés à anastomoses	174	Ecarteurs IMA	265-267
<b>CRAWFORD</b> Ecarteurs pour aorta	229	<b>DEBAKEY</b> Dilatateurs vasculaires	298	Ecarteurs pour aorte	229, 234
<b>CRILE BABY</b> Pincés hémostatiques	128	<b>DEBAKEY</b>		Ecarteurs pour costaux	264-295
<b>CRILE</b> Pincés hémostatiques	131	Ecarteurs pour costaux et sternum	274	Ecarteurs pour costaux et sternum	265-295
<b>CRILE WOOD BABY HM</b> Porte-aiguille	83	<b>DEBAKEY GLOVER AT</b>		Ecarteurs pulmonaire	229
<b>CRILE WOOD HM</b> Porte-aiguilles	84	Pince pour oreillette	169	Ecarteurs pour sternum	265-295
Crochets à nerfs	206	<b>DEBAKEY GLOVER AT</b>		Ecarteurs pour oreillette	230-233
Crochets à veines	206	Pincés à anastomoses	176	Ecarteurs scapulaires	229
Crochets fins	207-208	<b>DEBAKEY GLOVER AT</b>		<b>ECHLIN</b> Pincés-gouges	251
Crochets pour vaisseaux	206-212	Pincés vasculaires	159-160	<b>ELF</b> Crochet fin	208
<b>CUSHING</b> Crochets à nerfs	206	<b>DEBAKEY HARKEN AT</b>		<b>EUFRATE PASQUÉ HM</b> Porte-aiguilles	86
<b>CUSHING</b> Crochets pour vaisseaux	206	Pincés pour vena cava	188	Extracteurs phlebites	73
<b>CUSHING</b> Ecarteurs à veines	209, 212	<b>DEBAKEY HM</b> Ciseaux vasculaires	29		
<b>CUSHING HM</b> Pincés anatomiques	46	<b>DEBAKEY HM</b> Porte-aiguilles	84	<b>F</b>	
<b>CUSHING</b> Pince anatomique	46	<b>DEBAKEY</b> Instruments à aspiration	67, 69	<b>FARABEUF ALEXANDER</b> Rugine	244
<b>CUSHING</b> Pince chirurgical	46	<b>DEBAKEY PEAN AT</b>		<b>FAVALORO MORSE STERNAL</b>	
<b>CUSHING</b> Rugines	242	Pincés hémostatiques	135	Ecarteurs pour costaux et sternum	269
		<b>DEBAKEY SATINSKY AT</b>		<b>FAVALORO</b> Ciseaux vasculaires	32
<b>D</b>		Pincés pour vena cava	187	<b>FERGUSSON</b> Davier à os	257
<b>DALE AT</b>		<b>DEBAKEY SEMB AT</b> Pince à ligature	185	Fils d'acier à os	104
Pincés pour vaisseaux périphériques	179	<b>DEBOER</b> Ecarteur pour costaux et sternum	287	<b>FINOCHIETTO BABY HAIGHT</b>	
<b>DARDIK AT</b> Pincés vasculaires	161	<b>DEMARTEL</b> Ciseaux vasculaires	25	Ecarteurs pour costaux et sternum	279
<b>DAVIDSON</b> Ecarteurs scapulaires	229	<b>DEMARTEL POTTS</b> Ciseaux vasculaires	32	<b>FINOCHIETTO</b> Ciseaux pulmonaires	23
Daviers à os	256-257	<b>DERRA COOLEY AT</b>		<b>FINOCHIETTO</b>	
<b>DAVIS</b> Spatules vasculaires	78-79	Pincés à anastomoses	174	Ecarteurs pour costaux et sternum	280, 282, 285
<b>DEAVER BABY</b>		<b>DERRA DEBAKEY AT</b>		<b>FINOCHIETTO HM</b> Porte-aiguille	89
Ecarteurs et spatules pulmonaires	222	Pincés à anastomoses	174	<b>FINOCHIETTO INFANT</b>	
<b>DEAVER</b>		<b>DESMARRES</b>		Ecarteurs pour costaux et sternum	279
Ecarteurs et spatules pulmonaires	223-226	Ecarteurs et crochets pour vaisseaux	209	<b>FINOCHIETTO MEDICON</b>	
<b>DEBAKEY AT</b> Clamps Bulldog	125-126	Désoblitérateurs de veines	74	Ecarteur pour costaux et sternum	280
<b>DEBAKEY AT HUSFELDT</b>		Désoblitérateurs pour endartérectomie	75	<b>FINOCHIETTO</b>	
Pincés pour carotide	166-167	<b>DIEFFENBACH</b> Clamps Bulldog	123	Pince à préparation et à ligature	150
<b>DEBAKEY AT</b> Pincés à ligature	184-185	<b>DIETHRICH</b> Clamps Bulldog	122	<b>FINOCHIETTO RIENHOFF</b>	
<b>DEBAKEY AT</b> Pincés atraumatiques	48-55	<b>DIETHRICH GREGORY</b>		Ecarteur pour costaux et sternum	281
<b>DEBAKEY AT</b>		Ciseaux vasculaires	32	<b>FINSTERER</b> Tube à aspiration et irrigation	69
Pincés atraumatiques en titane	53-55	<b>DIETHRICH HEGEMANN</b>		<b>FISCH</b> Crochets fins	208
<b>DEBAKEY AT</b> Pincés hémostatiques	132	Ciseaux vasculaires	31	<b>FREEMAN GORNEY</b> Ciseaux vasculaires	28
<b>DEBAKEY AT</b>		Dilatateurs	298-299	<b>FRENCH EYE RYDER HM</b> Porte-aiguilles	85
Pincés pour anévrisme de l'aorte	183-184	Dilatateurs pour l'aorte	299	<b>FUCHSIG</b> Pince hémostatique	142
<b>DEBAKEY AT</b> Pincés pour coarctation	173	Dilatateurs vasculaires	298		
<b>DEBAKEY AT</b> Pincés pour l'aorte	189	<b>DINGMANN</b> Daviers à os	256	<b>G</b>	
<b>DEBAKEY AT</b>		Dissecteur phlébite	73	<b>GEISSENDOERFER OVERHOLT</b>	
Pincés pour occlusion tangentielle	168	<b>DIXON LOVELACE</b> Pincés hémostatiques	133	Pincés à préparation et à ligature	143
<b>DEBAKEY AT</b> Pincés pour patent ductus	171	<b>DOYEN</b> Rugines	245	<b>GEMINI</b> Pincés à préparation et à ligature	147
<b>DEBAKEY AT</b> Pincés pour saisir le tissu	201	<b>DUBOST</b>		<b>GIBBON BAILEY</b> Ecarteur pour costaux	264
<b>DEBAKEY AT</b>		Ecarteur pour costaux et sternum	276	<b>GIERTZ</b> Costotom	260
Pincés pour vaisseaux		<b>DUVAL AT</b> Pince pour saisir le tissu	201		
périphériques	177-178, 180	<b>DUVAL COLLIN</b>			
<b>DEBAKEY AT</b> Pincés vasculaires	155-156, 162-163	Pincés pour saisir le tissu	56		
		<b>DUVAL HM</b> Pincés pour saisir le tissu	200		
		<b>DUVAL</b> Pincés pour saisir le tissu	56, 200		

<b>GIL VERNET</b>		Huile pour entretenir les instruments	321	<b>KOSHIMA CASTROVIEJO</b>	
Ecarteurs et crochets pour vaisseaux	211	<b>HUSFELDT DEBAKEY AT</b>		Micro porte-aiguilles	91
<b>GILLIES</b> Crochets pour vaisseaux	207	Pincés pour carotide	166-167	<b>KOSHIMA</b> Ciseaux micro	35
<b>GILLIES</b> Pince chirurgical	45	<b>I</b>		<b>KOSHIMA JACOBSON ADSON</b>	
<b>GLOVER AT</b> Clamps Bulldog	126			Micro pince	60
<b>GLOVER COOLEY AT</b>		<b>IMA</b> Ecarteurs	265-267	<b>KOSHIMA MICRO JACOBSON</b>	
Pince à anastomoses	175	<b>INFANT FINOCHIETTO</b>		Pincés hémostatiques	129
<b>GLOVER COOLEY AT</b> Pince vasculaire	159	Ecarteurs pour costaux et sternum	279	<b>KOSHIMA</b> Micro Pincés	60
<b>GLOVER DEBAKEY AT</b>		Instruments à aspiration	66-69	<b>KRAYENBUEHL</b> Crochets pour vaisseaux	207
Pince pour oreillette	169	Instruments pour endartérectomie	75		
<b>GLOVER DEBAKEY AT</b>		Instruments pour fils métalliques	100-104	<b>L</b>	
Pincés à anastomoses	176	Instruments pour les veines	73	<b>LAHEY</b> Ecarteurs	213
<b>GLOVER DEBAKEY AT</b> Pincés vasculaires	159-160	Instruments pour varices	72-74	<b>LAHEY</b> Pincés à préparation et à ligature	145, 147
<b>GLOVER POTTS</b> Pince à anastomoses	175	<b>INTRACARDIAC</b> Porte-aiguilles	85	<b>LAHEY SWEET</b>	148
<b>GLOVER POTTS</b> Pince vasculaire	160			Pince à préparation et à ligature	
<b>GLUCK</b> Costotom	259	<b>J</b>		<b>LAMBERT KAY AT</b> Pince pour l'aorte	191
<b>GORNEY</b> Ciseaux vasculaires	27	<b>JACOBSON ADSON (KOSHIMA)</b>		<b>LAMBOTTE</b> Rugines	242
<b>GORNEY FREEMAN</b> Ciseaux vasculaires	28	Micro pince	60	<b>LANGENBECK</b> Davier à os	257
<b>GRAEFE ADSON</b> Pince chirurgical	43	<b>JACOBSON ADSON</b> Micro pince	59	<b>LANGENBECK</b> Ecarteurs	213-215
<b>GREENBERG PAR</b> Ciseaux à préparation	12	<b>JACOBSON</b> Ciseaux micro	39	<b>LANGENBECK HM</b> Porte-aiguilles	90
<b>GREGORY AT</b> Pincés vasculaires	157	<b>JACOBSON</b> Crochet fin	208	<b>LANGENBECK KOCHER</b> Ecarteurs	216
<b>GREGORY</b> Clamps Bulldog	127	<b>JACOBSON HM</b> Micro porte-aiguilles	92	<b>LANGENBECK</b> Rugine	242
<b>GREGORY DIETRICH</b> Ciseaux vasculaires	32	<b>JACOBSON MICRO (KOSHIMA)</b>		<b>LEBSCHKE</b> Burin à sternum	296
		Pincés hémostatiques	129	<b>LEES AT</b> Pincés-clamps pour bronches	153
<b>H</b>		<b>JACOBSON MICRO 2000</b> Ciseaux micro	35	<b>LEKSELL</b> Pincés-gouges	250
<b>HAIGHT BABY</b>		<b>JACOBSON</b> Micro pincés	59	<b>LELAND JONES AT</b>	177
Ecarteurs pour costaux et sternum	281	<b>JACOBSON MICRO</b> Pincés hémostatiques	138	Pincés pour vaisseaux périphériques	
<b>HAIGHT FINOCHIETTO BABY</b>		<b>JACOBSON</b> Micro porte-aiguilles	92	<b>LEMMON</b> Spatules vasculaires	78
Ecarteurs pour costaux et sternum	279	<b>JAMESON REYNOLDS</b>		<b>LEMOLE AT</b> Pincés pour l'aorte	166
<b>HAIMOVICI</b> Ciseaux vasculaires	25	Ciseaux à préparation	21	<b>LERICHE</b> Pincés hémostatiques	131
<b>HALLE</b> Spatule vasculaire	80	<b>JAVID</b> Pincés pour carotide	167	<b>LICHTENBERG HM</b> Porte-aiguilles	90
<b>HALSEY HM</b> Porte-aiguille	83	<b>JEU</b> pour tunnelisation	302-303	<b>LISTON KEY</b> Pince coupante à os	254
<b>HALSTED (ADSON)</b> Pincés hémostatiques	138	<b>JOHNS HOPKINS</b> Clamps Bulldog	124	<b>LISTON</b> Pincés coupantes à os	252
<b>HALSTED MICRO</b> Pincés hémostatiques	128	<b>JONES LELAND AT</b>		<b>LISTON RUSKIN</b> Pincés coupantes à os	253
<b>HALSTED MOSQUITO</b> Pincés hémostatiques	130	Pincés pour vaisseaux périphériques	177	<b>LISTON STILLE</b> Pincés coupantes à os	254
<b>HARKEN DEBAKEY AT</b>		<b>JULIAN HM</b> Porte-aiguilles	84	<b>LITTAUER</b> Pince coupante à os	253
Pincés pour vena cava	188			<b>LOCKLIN</b> Ciseaux à tissu	23
<b>HARKEN NISSEN</b>		<b>K</b>		<b>LOVE (MORSE)</b>	212
Ecarteur pour costaux et sternum	284	<b>KADER</b> Ecarteurs et spatules pulmonaires	227	Ecarteurs et crochets pour vaisseaux	
<b>HARRINGTON BABY</b>		<b>KAY LAMBERT AT</b> Pince pour l'aorte	191	<b>LOVELACE DIXON</b> Pince hémostatique	133
Ecarteur et spatule pulmonaire	221	<b>KELLY</b> Ciseaux délicats	10	<b>LOVELACE</b> Pince hémostatique	133
<b>HARRINGTON</b>		<b>KELLY</b> Ecarteur	219	<b>LUCAE</b> Crochets pour vaisseaux	206
Ecarteurs et spatules pulmonaires	221	<b>KEY LISTON</b> Pince coupante à os	254	<b>LUER STILLE</b> Pincés-gouges	248
<b>HARRINGTON PEMBERTON</b>		<b>KILNER RAGNELL</b> Ciseaux à préparation	13		
Ecarteur et spatule pulmonaire	222	<b>KLINKENBERGH</b> Ciseaux vasculaires	24	<b>M</b>	
<b>HEANEY HM</b> Porte-aiguille	87	<b>KOCHER ALLEN</b> Pincés hémostatiques	132	<b>MAGIC CUT</b> Ciseaux	9-10, 12, 14-18, 20-21, 27-28, 31, 33
<b>HEGAR CORWIN</b> Pince serre-fil	104	<b>KOCHER BABY</b> Pincés hémostatiques	128	<b>MARBERGER</b>	
<b>HEGAR MAYO HM</b> Porte-aiguilles	83	<b>KOCHER LANGENBECK</b> Ecarteurs	216	Ecarteurs et crochets pour vaisseaux	210
<b>HEGEMANN DIETRICH</b>		<b>KOCHER</b> Pincés hémostatiques	133	<b>MASSON HM</b> Porte-aiguille	88
Ciseaux vasculaires	31	<b>KOCHER ROCHESTER OCHSNER</b>		<b>MATHIEU HM</b> Porte-aiguilles	90
<b>HEISS</b> Pincés hémostatiques	139, 142	Pincés hémostatiques	136	<b>MATHIEU RYDER MICRO HM</b>	
<b>HENLY AT</b> Pince pour artère subclavia	165	<b>KOENIG</b>		Porte-aiguilles	90
<b>HM</b> Ciseaux	9-10, 12-20, 27-29, 33	Ecarteurs et crochets pour vaisseaux	209	<b>MATSON</b> Rugine	244
<b>HOEPFNER</b> Pince vasculaire	159			<b>MAYO HEGAR HM</b> Porte-aiguilles	83
<b>HOPKINS JOHNS</b> Clamps Bulldog	124				
<b>HOPT AT</b> Pincés pour artères rénales	182				

<b>MAYO</b> Instruments pour varices	74	<b>MIXTER</b> Pincés à préparation et à ligature	145, 149	<b>PEAN ROCHESTER</b> Pincés hémostatiques	134
<b>MAYO</b> Pince pour saisir le tissu	57	<b>MOLDESTAD</b> Crochet pour vaisseaux	206	<b>PEMBERTON HARRINGTON</b>	
<b>MCINDOE</b> Pince anatomique	45	<b>MORSE FAVALORO STERNAL</b>		Ecarteur et spatule pulmonaires	222
<b>MCINDOE</b> Pincés coupantes à os	253	Ecarteurs pour costaux et sternum	269	Perforateurs pour l'aorte	304
<b>MEDICON</b> Ecarteur pour costaux	264	<b>MORSE LOVE</b>		<b>PERWIZSCHKY</b> Ciseaux vasculaires	24
<b>MEDICON</b> Ecarteurs autostatiques	236	Ecarteurs et crochets pour vaisseaux	212	<b>PETERSEN SMITH</b> Pincés-gouges	248
<b>MEDICON FINOCHIETTO</b>		<b>MORSE MEDICON STERNLA</b>		Pince à ligature	116
Ecarteur pour costaux et sternum	280	Ecarteurs pour costaux et sternum	270	Pince pour artère subclavia	165
<b>MEDICON HM</b> Pince serre-fil	102	<b>MORSE STERNAL</b>		Pince pour oreillette	169
<b>MEDICON IMA</b> Ecarteurs	266-267	Ecarteurs pour costaux et sternum	268	Pince pour poser les clamps Bulldog	125
<b>MEDICON MORSE STERNAL</b>		<b>MORSE AT</b> Pincés hémostatiques	129	Pincés	42-64, 120-197
Ecarteurs pour costaux et sternum	270	<b>MOSQUITO HALSTED</b>		Pincés à anastomoses	174-176
<b>MEDICON PACKER (SKILLMAN)</b>		Pincés hémostatiques	130	Pincés à appliquer les clips	106, 110-111, 113-115, 117
Pincés hémostatiques	130	<b>MUELLER</b> Approximateurs	114	Pincés à ligature	143-150, 184-185
<b>MEDICON</b> Pince serre-fil	102	<b>MUELLER</b> Clips vasculaires	116	Pincés à préparation	143-150
<b>MEDICON ANKENEY</b>		<b>MUELLER</b> Micro clips vasculaires	114	Pincés à suture	61, 63-64
Ecarteurs pour costaux et sternum	277-278	<b>MYERS</b> Instruments pour varices	74	Pincés anatomiques	42-46
<b>MEEKER</b> Pince hémostatique	140			Pincés atraumatiques	47-55, 120-121, 125-127, 129, 132, 135, 153-185, 187-196
<b>MEHDORN</b> Micro clips vasculaires	115	<b>N</b>		Pincés atraumatiques en titane	53-55
<b>MEHDORN</b> Pince à appliquer les clips	115	<b>NABATOFF</b> Trousse pour varices	72	Pincés chirurgicales	43-46
<b>MERZ</b> Perforateur pour l'aorte	304	<b>NELSON</b> Ciseaux à préparation	17-18	Pincés coupantes à os	252-254
<b>METZENBAUM BABY</b>		<b>NELSON</b> Pincés pour saisir le tissu	56	Pincés coupe-fil	100-101
Ciseaux à préparation	14	<b>NEONATAL AT</b> Pincés pour nouveaux-nés	192-193	Pincés coupe-fil HM	100-101
<b>METZENBAUM</b> Ciseaux à préparation	15-16	<b>NEONATAL CASTANEDA AT</b>		Pincés en titane	120-121, 130-131
<b>METZENBAUM SLIM</b>		Pincés pour nouveaux-nés	196	Pincés fines	43-45
Ciseaux à préparation	19-21	<b>NIRO HM</b> Pince serre-fil	102	Pincés hémostatiques	128-142
<b>MICRO 2000 (KOSHIMA)</b> Micro Pince	60	<b>NIRO</b> Pince serre-fil	102	Pincés hémostatiques en titane	130-131
<b>MICRO 2000</b> Ciseaux micro	34-36	<b>NISSEN HARKEN</b>		Pincés micro	58-64
<b>MICRO 2000</b> Micro pincés	60-63	Ecarteur pour costaux et sternum	284	Pincés plates	103
<b>MICRO 2000</b> Micro porte-aiguilles	95-97			Pincés polyvalents	156-163
<b>MICRO ADSON</b> Pince anatomique	43	<b>O</b>		Pincés pour anévrisme de l'aorte	183-184
<b>MICRO ADSON</b> Pince chirurgical	43	<b>OBWEGESER</b> Pince plate	103	Pincés pour artères rénales	181-182
<b>MICRO CASTROVIEJO</b>		<b>OBWEGESER</b> Rugines	246	Pincés pour carotide	166-167
Micro porte-aiguilles	91	<b>OCHSNER ROCHESTER KOCHER</b>		Pincés pour cathéters	197
Micro ciseaux	33-39	Pincés hémostatiques	136	Pincés pour coarctation	172-173
Micro clips vasculaires	107-109, 111-115	<b>O'SHAUGNESSY</b>		Pincés pour l'aorte	166, 189-191
<b>MICRO HALSTED</b> Pincés hémostatiques	128	Pince à préparation et à ligature	146	Pincés pour l'aorte abdominale	164-165
<b>MICRO JACOBSON (KOSHIMA)</b>		<b>OVERHOLT GEISSENDOERFER</b>		Pincés pour nouer les fils	64
Pincés hémostatiques	129	Pincés à préparation et à ligature	143	Pincés pour nouveaux-nés	192-196
<b>MICRO JACOBSON</b> Pincés hémostatiques	138	<b>OVERHOLT MIOTTI</b>		Pincés pour occlusion tangentielle	168
Micro pincés	58-64	Pincés à préparation et à ligature	144	Pincés pour patent ductus	170-171
Micro pincés en titane	58	<b>OVERHOLT MIXTER</b>		Pincés pour poser les clips	106, 110-111, 113-115, 117
Micro pincés pour nouer les fils	64	Pince à préparation et à ligature	146	Pincés pour poser les clips pour clips en titane	106
Micro porte-aiguilles	91-97	<b>OVERHOLT SLIM</b>		Pincés pour saisir	200-204
Micro porte-aiguilles en titane	94	Pincés à préparation et à ligature	144	Pincés pour saisir le tissu	56-57, 200-204
<b>MICRO SLIM HM</b> Porte-aiguilles	85			Pincés pour saisir le tissu HM	200, 203
<b>MICROVASCULAR HM</b> Porte-aiguilles	86	<b>P</b>		Pincés pour vaisseaux périphériques	177-180
<b>MIKULICZ</b> Ecarteurs	219-220	<b>PACKER MEDICON (SKILLMAN)</b>		Pincés pour veine iliaque	169
<b>MILLES</b> Ciseaux micro	39	Pincés hémostatiques	130	Pincés pour vena cava	186-188
<b>MILLS</b> Ciseaux vasculaires	32	<b>PEAN AT</b> Pincés hémostatiques	135	Pincés serre-fil	102-104
<b>MINI RYDER HM</b> Porte-aiguilles	85	<b>PEAN BABY</b> Pincés hémostatiques	128	Pincés vasculaires	48-55, 155-197
<b>MIOTTI OVERHOLT</b>		<b>PEAN DEBAKEY AT</b> Pincés hémostatiques	135	Pincés-clamps pour bronches	151-154
Pincés à préparation et à ligature	144	<b>PEAN</b> Pincés hémostatiques	133	Pincés-gouges	247-251
<b>MIXTER BABY</b>				Plateau de stérilisation	320
Pincés à préparation et à ligature	145				
<b>MIXTER CRAFOORD</b>					
Pincés à préparation et à ligature	148				
<b>MIXTER OVERHOLT</b>					
Pince à préparation et à ligature	146				

Porte-aiguilles	82-97	<b>SAUERBRUCH</b> Costotom	260	<b>SUBRAMANIAN</b>	
Porte-aiguilles HM	83-92	<b>SAUERBRUCH</b> Ecarteur	217	Pincés pour nouveaux-nés	195
Porte-aiguilles HM explications	82	<b>SCHMID</b>		<b>SUPERCUT</b> Ciseaux	9-10, 12-21, 27-28, 30-31, 36-37
Porte-aiguilles micro	91-97	Canules pour lavage des vaisseaux	76	<b>SUPERCUT PLUS</b> Ciseaux	9-10, 12-20
<b>POTTS DEMARTEL</b> Ciseaux vasculaires	32	<b>SCHMID</b> Spatules vasculaires	78	<b>SWEET LAHEY</b>	
<b>POTTS GLOVER</b> Pince à anastomoses	175	<b>SCHOENBORN</b> Ecarteurs	213	Pince à préparation et à ligature	148
<b>POTTS GLOVER</b> Pince vasculaire	160	<b>SCHWARTZ</b> Clips vasculaires	117	<b>SYPERT</b> Pince-gouge	251
<b>POTTS</b> Pincés pour coarctation	172	<b>SCHWARTZ</b> Pince à appliquer les clips	117		
<b>POTTS</b> Pincés pour patent ductus	170	<b>SELECT</b> Pincés anatomiques	44	<b>T</b>	
<b>POTTS SATINSKY</b> Pince à anastomoses	175	<b>SELECT</b> Pincés chirurgicales	44		
<b>POTTS SATINSKY</b> Pincés pour vena cava	187	<b>SELLORS CRAFOORD</b>		<b>THOMAS PRICE</b>	
<b>POTTS SMITH</b> Ciseaux vasculaires	26, 30	Pincés hémostatiques	137	Pincés-clamps pour bronches	151
<b>POTTS SMITH HM</b> Pincés anatomiques	42	<b>SELLORS</b> Ecarteur pour costaux	264	Titane Bulldog clamps	120-121
<b>POTTS SMITH</b> Pincés anatomiques	45	<b>SEMB</b> Daviers à os	257	Titane ciseaux micro	38
<b>POTTS SMITH</b> Pincés chirurgicales	45	<b>SEMB</b> DEBAKEY AT Pince à ligature	185	Titane clips vasculaires	106
<b>POTTS YASARGIL</b> Ciseaux micro	39	<b>SEMB</b> Ecarteur pulmonaire	229	Titane micro pincés	58
<b>PRICE THOMAS</b>		<b>SEMB</b> Pincés à préparation et à ligature	150	Titane micro porte-aiguilles	94
Pincés-clamps pour bronches	151	<b>SEMB</b> Rugines	243	Titane pincés	120-121, 130-131
Propositions pour boîtes	308-318	<b>SEMB STILLE</b> Pincés-gouges	249	Titane pincés atraumatiques	53-55
<b>PYNCHON ANDREWS</b>		<b>SEMKEN</b> Pincés chirurgicales	44	Titane pincés hémostatiques	130-131
Instrument à aspiration	67	<b>SENNING HM</b> Porte-aiguilles	88	<b>TOENNIS HM</b> Porte-aiguilles	90
		<b>SENNING</b> Porte-aiguille	88	<b>TOENNIS</b> Spatules vasculaires	79
<b>R</b>		<b>SHEA</b> Ciseaux à préparation	12	Tourniquets	298
		<b>SIEGERT</b> Ciseaux délicats	10	Trousse pour varoces	72-73
<b>RAGNELL (KILNER)</b> Ciseaux à préparation	13	<b>SKILLMAN MEDICON PACKER</b>		<b>TUBBS</b> Dilatateur pour l'aorte	299
<b>REYNOLDS (JAMESON)</b>		Pincés hémostatiques	130	Tube à aspiration et irrigation	69
Ciseaux à préparation	21	<b>SLIM</b> Ciseaux à préparation	14	<b>TUFFIER</b>	
<b>RIENHOFF FINOCHIETTO</b>		<b>SLIM METZENBAUM</b>		Ecarteurs pour costaux et sternum	288
Ecarteur pour costaux et sternum	281	Ciseaux à préparation	19-21	<b>TUTTLE</b> Pincés pour saisir le tissu	56
<b>ROCHESTER OCHSNER KOCHER</b>		<b>SLIM MICRO HM</b> Porte-aiguilles	85		
Pincés hémostatiques	136	<b>SLIM OVERHOLT</b>		<b>U</b>	
<b>ROCHESTER PEAN</b>		Pincés à préparation et à ligature	144		
Pincés hémostatiques	134	<b>SLIM RYDER HM</b> Porte-aiguilles	86	<b>ULTRA</b> Pincés hémostatiques	129
<b>ROSS</b> Ecarteurs pour aorte	234	<b>SMITH PETERSEN</b> Pincés-gouges	248	<b>UNIVERSAL</b> Ciseaux coupe-fil	100
Rugines	242-246	<b>SMITH POTTS</b> Ciseaux vasculaires	26, 30	<b>UNIVERSAL HM</b> Ciseaux coupe-fil	100
<b>RUMEL BELMONT</b> Tourniquets	298	<b>SMITH POTTS HM</b>		<b>UNIVERSAL</b> Pince serre-fil	103
<b>RUSKIN LISTON</b> Pincés coupantes à os	253	Pincés anatomiques	42		
<b>RYDER (FRENCH EYE) HM</b>		<b>SMITH POTTS</b> Pincés anatomiques	45	<b>V</b>	
Porte-aiguilles	85	<b>SMITH POTTS</b> Pincés chirurgicales	45		
<b>RYDER MATHIEU MICRO HM</b>		Spatules pulmonaires	221-228	Valvulotomes	305
Porte-aiguilles	90	Spatules vasculaires	78-80	<b>VARADY</b> Dissecteur pflébite	73
<b>RYDER MINI HM</b> Porte-aiguilles	85	<b>STERNAL CASTANEDA</b>		<b>VARADY</b> Extracteurs phlébites	73
<b>RYDER SLIM HM</b> Porte-aiguilles	86	Ecarteurs pour costaux et sternum	283	<b>VERNET GIL</b>	
		<b>STERNAL MEDICON MORSE</b>		Ecarteurs et crochets pour vaisseaux	211
		Ecarteurs pour costaux et sternum	270		
<b>S</b>		<b>STERNAL MORSE</b>		<b>W</b>	
		Ecarteurs pour costaux et sternum	268		
<b>SACHS</b> Spatule vasculaire	78	<b>STERNAL MORSE FAVALORO</b>		<b>WANGENSTEEN HM</b>	
<b>SAROT</b> HM Porte-aiguilles	84	Ecarteurs pour costaux et sternum	269	Pincés pour saisir le tissu	57
<b>SAROT</b> Pincés hémostatiques	137	<b>STEVENS</b> Ciseaux délicats	9	<b>WANGENSTEEN HM</b> Porte-aiguille	89
<b>SAROT</b> Pincés-clamps pour bronches	152	<b>STILLE LISTON</b> Pincés coupantes à os	254	<b>WANGENSTEEN</b> Pincés pour saisir le tissu	57
<b>SATINSKY BABY</b> Pince pour vena cava	186	<b>STILLE LUER</b> Pincés-gouges	248	<b>WEBER AT</b> Pincés pour l'aorte	190
<b>SATINSKY</b> Ciseaux vasculaires	24, 26	<b>STILLE</b> Pince-gouge	249	<b>WEITLANER BECKMANN</b>	
<b>SATINSKY DEBAKEY AT</b>		<b>STILLE SEMB</b> Pincés-gouges	249	Ecarteurs autostatiques	238
Pincés pour vena cava	187	<b>STRATTE</b> HM Porte-aiguilles	87		
<b>SATINSKY</b> Pincés pour vena cava	186	<b>STRUCKE</b> Ecarteur pour costaux et sternum	275		
<b>SATINSKY POTTS</b> Pince à anastomoses	175	<b>STRULLY</b> Ciseaux vasculaires	27		
<b>SATINSKY POTTS</b> Pincés pour vena cava	187	<b>SUBRAMANIAN DEBAKEY AT</b>			
		Pince pour nouveaux-nés	195		



## Indice alfabético, pagina

<b>WEITLANER</b> Ecarteurs autostatiques	236-237
<b>WERTHEIM BOZEMANN HM</b>	
Porte-aiguilles	87
<b>WIKSTROEM</b>	
Pince à préparation et à ligature	146
<b>WILLAUER</b> Ciseaux pulmonaires	22
<b>WILLIAMS</b> Pince pour saisir le tissu	202
<b>WOOD CRILE HM</b> Porte-aiguilles	84
<b>WYLIE AT</b> Pincés pour l'aorte abdominale	164

### Y

<b>YANKAUER</b> Instruments à aspiration	66-67
<b>YASARGIL</b> Ciseaux micro	34, 39
<b>YASARGIL</b> Micro porte-aiguilles	95, 97
<b>YASARGIL POTTS</b> Ciseaux micro	39

### Z

<b>ZANGER AT</b>	
Pincés pour l'aorte abdominale	165
<b>ZENKER</b> Ecarteurs	217



<b>A</b>		<b>BABY METZENBAUM</b>		<b>CASTROVIEJO HM</b> Micro port'aghi 91	
Accessori	320-321	Forbici per preparazione	14	<b>CASTROVIEJO MICRO</b> Micro port'aghi 91	
<b>ACLAND</b> Approssimatori	108-109	<b>BABY MIXTER</b>		<b>CASTROVIEJO</b> Micro port'aghi 91	
<b>ACLAND</b> Micro clip vascolari	107-109	Pinze per preparazione e per legatura	145	Clip per legatura	116
<b>ACLAND</b> Pinze per applicare clip	110	<b>BABY PEAN</b> Pinze emostatiche	128	Clip vascolari	106-109, 111-117
<b>ADSON BABY</b>		<b>BABY SATINSKY</b> Pinza per vena cava	186	Clip vascolari in titanio	106
Pinze per preparazione e per legatura	145	<b>BAILEY</b> Divaricatore costali	264	Clip vascolari micro	107-109, 111-115
<b>ADSON BECKMANN</b>		<b>BAILEY GIBBON</b> Divaricatore costali	264	<b>COLLIN CORYLLOS BETHUNE</b> Costotomi	258
Divaricatori autostatici	239	<b>BAILEY</b> Perforatore per aorta	304	<b>COLLIN DUVAL</b> Pinze per afferrare tessuti	56
<b>ADSON BROWN</b> Pinze chirurgiche	43	<b>BAINBRIDGE DEBAKEY AT</b>		<b>COLLIN</b> Pinza per afferrare tessuto	200
<b>ADSON</b> Divaricatore autostatico	239	Pinze emostatiche	132	<b>COOLEY AT</b> Pinza per anastomose	175
<b>ADSON GRAEFE</b> Pinza chirurgica	43	<b>BARRAQUER</b> Micro port'aghi	92	<b>COOLEY AT</b> Pinze neonatale	192-194
<b>ADSON HALSTED</b> Pinze emostatiche	138	<b>BAUMGARTNER HM</b> Port'aghi	83	<b>COOLEY AT</b> Pinze per arteria renale	181
<b>ADSON HM</b> Pinza anatomica	43	<b>BECK DEBAKEY AT</b> Pinze per vena cava	188	<b>COOLEY AT</b> Pinze per coarctazione	172
<b>ADSON HM</b> Pinza chirurgica	43	<b>BECKMANN ADSON</b>		<b>COOLEY AT</b> Pinze per i bronchi	154
<b>ADSON JACOBSON (KOSHIMA)</b>		Divaricatori autostatici	239	<b>COOLEY AT</b> Pinze per patent ductus	170
Micro pinza	60	<b>BECKMANN</b> Divaricatore autostatico	238	<b>COOLEY AT</b> Pinze per vena iliaca	169
<b>ADSON JACOBSON</b> Micro pinza	59	<b>BECKMANN EATON</b>		<b>COOLEY AT</b> Pinze vascolari	156-159
<b>ADSON MICRO</b> Pinza anatomica	43	Divaricatore autostatico	239	<b>COOLEY DERRA AT</b> Pinze per anastomosi	174
<b>ADSON MICRO</b> Pinza chirurgica	43	<b>BECKMANN WEITLANER</b>		<b>COOLEY</b> Dilatatore per l'aorta	299
<b>ADSON</b> Pinze emostatiche	138	Divaricatori autostatici	238	<b>COOLEY</b>	
<b>ALEXANDER FARABEUF</b>		<b>BELMONT RUMEL</b> Compressori	298	Divaricatori costali e sternali	286, 289-295
Periostotomo	244	<b>BENGOLEA</b> Pinze emostatiche	141	<b>COOLEY GLOVER AT</b>	
<b>ALLEN KOCHER</b> Pinze emostatiche	132	<b>BETHUNE CORYLLOS (COLLIN)</b>		Pinza per anastomose	175
<b>ALLIS AT</b> Pinze per afferrare tessuti	202	Costotomi	258	<b>COOLEY GLOVER AT</b> Pinza vascolare	159
<b>ALLISON</b> Spatole per polmoni	228	<b>BETHUNE</b> Costotomo	259	<b>COOLEY</b> Pinze per catetere	197
<b>ALM</b> Divaricatori autostatici	236	<b>BIEMER</b> Approssimatore	111-112	<b>COOLEY</b> Strumenti d'aspirazione	68
<b>ANDREWS PYNCHON</b>		<b>BIEMER</b> Approssimatore per nervi	112	<b>COOLEY</b> Uncini d'atrio	230-233
Strumento d'aspirazione	67	<b>BIEMER</b> Divaricatore per vasi	117	<b>CORWIN HEGAR</b> Pinza tenda filo d'acciaio	104
<b>ANKENEY MEDICON</b>		<b>BIEMER</b> Forbice per vene	39	<b>CORYLLOS BETHUNE (COLLIN)</b> Costotomi	258
Divaricatori costali e sternali	277-278	<b>BIEMER</b> Micro clip vascolari	111	<b>CORYLLOS</b> Divaricatori	218
Approssimatore per nervi	112	<b>BIEMER MUELLER</b> Approssimatori	113	Costotomi	258-261
Approssimatori	108-109, 111-114	<b>BIEMER MUELLER</b> Micro clip vascolari	113	<b>CRAFOORD</b> Forbice polmonari	22
<b>AUSTIN</b> Pinza per annodare fili	64	<b>BIEMER</b> Pinze per applicare clip	111, 113-114	<b>CRAFOORD MIXTER</b>	
<b>B</b>		<b>BLACK LINE</b> Forbici	9-10, 12-21, 27-28	Pinze per preparazione e per legatura	148
<b>BABCOCK AT</b> Pinze per afferrare tessuti	204	<b>BLANK</b> Pinze anatomiche	42	<b>CRAFOORD SELLORS</b> Pinze emostatiche	137
<b>BABCOCK BABY</b>		<b>BOYD</b> Forbice vascolare	25	<b>CRAWFORD</b> Divaricatori per aorta	229
Pinza per afferrare tessuto	203	<b>BOZEMANN (WERTHEIM) HM</b> Port'aghi	87	<b>CRILE BABY</b> Pinze emostatiche	128
<b>BABCOCK HM</b> Pinze per afferrare tessuti	203	<b>BRIDGE</b> Pinze emostatiche	140	<b>CRILE</b> Pinze emostatiche	131
<b>BABCOCK</b> Pinze per afferrare tessuti	203	<b>BROPHY</b> Pinze anatomiche	45	<b>CRILE WOOD BABY HM</b> Port'aghi	83
<b>BABY ADSON</b>		<b>BROPHY</b> Pinze chirurgiche	45	<b>CRILE WOOD HM</b> Port'aghi	84
Pinze per preparazione e per legatura	145	<b>BROWN ADSON</b> Pinze chirurgiche	43	<b>CUSHING</b> Divaricatori per vene	209, 212
<b>BABY BABCOCK</b>		<b>BROWN</b> Pinze per afferrare tessuti	57	<b>CUSHING HM</b> Pinze anatomiche	46
Pinza per afferrare tessuto	203	<b>BRUNNER</b> Costotomi	261	<b>CUSHING</b> Periostotomi	242
<b>BABY CRILE</b> Pinze emostatiche	128	Bulldog pinze	120-127, 155	<b>CUSHING</b> Pinza anatomica	46
<b>BABY CRILE WOOD HM</b> Port'aghi	83	Bulldog pinze atraumatiche	120-121, 125-127	<b>CUSHING</b> Pinza chirurgica	46
<b>BABY DEAVER</b>		<b>BURFORD</b> Divaricatori costali e sternali	271-273	<b>CUSHING</b> Uncinetti vascolari	206
Divaricatori e spatole per polmoni	222	<b>C</b>		<b>CUSHING</b> Uncini per nervi	206
<b>BABY FINOCHIETTO HAIGHT</b>		Cannula d'aspirazione e lavaggio	69	<b>D</b>	
Divaricatori costali e sternali	279	Cannule di lavaggio per vasi	76	<b>DALE AT</b>	
<b>BABY HAIGHT</b>		Cassetta per strumenti	320	Pinze emostatiche per vasi periferici	179
Divaricatori costali e sternali	281	<b>CASTANEDA AT NEONATAL</b>		<b>DARDIK AT</b> Pinze vascolari	161
<b>BABY HARRINGTON</b>		Pinze neonatale	196	<b>DAVIDSON</b> Divaricatori scapola	229
Divaricatori e spatole per polmoni	221	<b>CASTANEDA STERNAL</b>		<b>DAVIS</b> Spatole vascolari	78-79
<b>BABY KOCHER</b> Pinze emostatiche	128	Divaricatori costali e sternali	283	<b>DEAVER BABY</b>	
		<b>CASTROVIEJO (KOSHIMA)</b> Micro port'aghi	91	Divaricatori e spatole per polmoni	222

<b>DEAVER</b>					
Divaricatori e spatole per polmoni	223-226				
<b>DEBAKEY AT HUSFELD</b> Pinze carotisi	166-167				
<b>DEBAKEY AT</b> Pinze atraumatiche	48-55				
<b>DEBAKEY AT</b> Pinze atraumatiche in titanio	53-55				
<b>DEBAKEY AT</b> Pinze Bulldog	125-126				
<b>DEBAKEY AT</b> Pinze emostatiche	201				
<b>DEBAKEY AT</b>					
Pinze emostatiche per vasi perfici	177-178, 180				
<b>DEBAKEY AT</b> Pinze per afferrare tessuti	132				
<b>DEBAKEY AT</b>					
Pinze per aneurisma de aorta	183-184				
<b>DEBAKEY AT</b> Pinze per aorta	189				
<b>DEBAKEY AT</b> Pinze per coarctazione	173				
<b>DEBAKEY AT</b> Pinze per legatura	184-185				
<b>DEBAKEY AT</b>					
Pinze per occlusione tangenziale	168				
<b>DEBAKEY AT</b> Pinze per patent ductus	171				
<b>DEBAKEY AT</b> Pinze vascolari	155-156, 162-163				
<b>DEBAKEY AT SUBRAMANIAN</b>					
Pinza neonatale	195				
<b>DEBAKEY BAINBRIDGE AT</b>					
Pinze emostatiche	132				
<b>DEBAKEY BECK AT</b> Pinze per vena cava	188				
<b>DEBAKEY DERRA AT</b>					
Pinze per anastomosi	174				
<b>DEBAKEY</b> Dilatatori vascolari	298				
<b>DEBAKEY</b> Divaricatori costali e sternali	274				
<b>DEBAKEY</b> Forbici vascolari	26, 29, 32				
<b>DEBAKEY GLOVER AT</b>					
Pinze per anastomosi	176				
<b>DEBAKEY GLOVER AT</b> Pinza per auricola	169				
<b>DEBAKEY GLOVER AT</b> Pinze vascolari	159-160				
<b>DEBAKEY HARKEN AT</b>					
Pinze per vena cava	188				
<b>DEBAKEY HM</b> Forbice vascolare	29				
<b>DEBAKEY HM</b> Port'aghi	84				
<b>DEBAKEY PEAN AT</b> Pinze emostatiche	135				
<b>DEBAKEY SATINSKY AT</b>					
Pinze per vena cava	187				
<b>DEBAKEY SEMB AT</b> Pinza per legatura	185				
<b>DEBAKEY</b> Strumenti d'aspirazione	67, 69				
<b>DEBOER</b> Divaricatore per costali e sterno	287				
<b>DEMARTEL</b> Forbici vascolari	25				
<b>DEMARTEL POTTS</b> Forbice vascolare	32				
<b>DERRA COOLEY AT</b> Pinze per anastomosi	174				
<b>DERRA DEBAKEY AT</b>					
Pinze per anastomosi	174				
<b>DESMARRES</b> Uncini e divaricatori per vasi	209				
<b>DIEFFENBACH</b> Pinze Bulldog	123				
<b>DIETHRICH GREGORY</b> Forbice vascolare	32				
<b>DIETHRICH HEGEMANN</b> Forbici vascolari	31				
<b>DIETHRICH</b> Pinze Bulldog	122				
Dilatatori	298-299				
Dilatatori per aorta	299				
Dilatatori vascolari	298				
<b>DINGMANN</b> Tenaglie per ossa	256				
Disobliteratori di vene	74				
Disobliteratori per endarterectomia	75				
Dissettoflebo	73				
Divaricatore epicardiaco	236				
Divaricatori per atrio	230-231				
Divaricatore per vasi	117				
Divaricatori	209-227				
Divaricatori autostatici	236-239				
Divaricatori costali	264-295				
Divaricatori costali e sternali	265-295				
Divaricatori IMA	265-267				
Divaricatori per aorta	229, 234				
Divaricatori per polmoni	229				
Divaricatori per scapola	229				
Divaricatori sternali	265-295				
Divaricatori per vene	209, 212				
<b>DIXON LOVELACE</b> Pinza emostatica	133				
<b>DOYEN</b> Periostotomi	245				
<b>DUBOST</b> Divaricatore costali e sternali	276				
<b>DUVAL AT</b> Pinza per afferrare tessuti	201				
<b>DUVAL COLLIN</b>					
Pinze per afferrare tessuti	56				
<b>DUVAL HM</b> Pinze per afferrare tessuti	200				
<b>DUVAL</b> Pinze per afferrare tessuti	56, 200				
<b>E</b>					
<b>EASY CUT HM</b> Tenaglia tagliafilii	101				
<b>EATON BECKMANN</b>					
Divaricatore autostatico	239				
<b>ECHLIN</b> Pinze-sgorbie	251				
<b>ELF</b> Uncino fino	208				
Estrattori flebo	73				
<b>EUFRATE PASQUÉ HM</b> Port'aghi	86				
<b>F</b>					
<b>FARABEUF ALEXANDER</b> Periostotomo	244				
<b>FAVALORO MORSE STERNAL</b>					
Divaricatori costali e sternali	269				
<b>FAVALORO</b> Forbice vascolare	32				
<b>FERGUSON</b> Tenaglia per ossa	257				
Filo d'acciaio per ossa	104				
<b>FINOCHIETTO BABY HAIGHT</b>					
Divaricatori costali e sternali	279				
<b>FINOCHIETTO</b>					
Divaricatori costali e sternali	280, 282, 285				
<b>FINOCHIETTO</b> Forbice polmonare	23				
<b>FINOCHIETTO HM</b> Port'aghi	89				
<b>FINOCHIETTO INFANT</b>					
Divaricatori costali e sternali	279				
<b>FINOCHIETTO MEDICON</b>					
Divaricatori costali e sternali	280				
<b>FINOCHIETTO</b>					
Pinza per preparazione e per legatura	150				
<b>FINOCHIETTO RIENHOFF</b>					
Divaricatori costali e sternali	281				
<b>FINSTERER</b>					
Cannula d'aspirazione e lavaggio	69				
<b>FISCH</b> Uncini fini	208				
Forbice per preparazione	12				
Forbice per tessuto	23				
Forbice per vene	39				
Forbici	2-40				
Forbici black line	9-10, 12-21, 27-28				
Forbici chirurgiche	11				
Forbici delicate	9-10				
Forbici HM	9-10, 12-20, 27-29, 33				
Forbici magic cut	9-10, 12, 14-18, 20-21, 27-28, 31, 33				
Forbici micro	33-39				
Forbici micro in titanio	38				
Forbici per legatura	40				
Forbici per preparazione	12-21				
Forbici per tagliare fili d'acciaio	100				
Forbici per tunnelizzare	10				
Forbici polmonari	22-23				
Forbici spiegazioni	2-8				
Forbici supercut	9-10, 12-21, 27-28, 30-31, 36-37				
Forbici supercut plus	9-10, 12-20				
Forbici vascolari	24-32				
<b>FREEMAN GORNEY</b> Forbici vascolari	28				
<b>FRENCH EYE RYDER HM</b> Port'aghi	85				
<b>FUCHSIG</b> Pinza emostatica	142				
<b>G</b>					
<b>GEISSENDOERFER OVERHOLT</b>					
Pinze per preparazione e per legatura	143				
<b>GEMINI</b>					
Pinze per preparazione e per legatura	147				
<b>GIBBON BAILEY</b> Divaricatore per costali	264				
<b>GIERTZ</b> Costotomo	260				
<b>GIL VERNET</b> Uncini e divaricatori per vasi	211				
<b>GILLIES</b> Pinza chirurgica	45				
<b>GILLIES</b> Uncinettivascolari	207				
<b>GLOVER AT</b> Pinze Bulldog	126				
<b>GLOVER COOLEY AT</b>					
Pinza per anastomose	175				
<b>GLOVER COOLEY AT</b> Pinza vascolare	159				
<b>GLOVER DEBAKEY AT</b> Pinza per auricola	169				
<b>GLOVER DEBAKEY AT</b>					
Pinze per anastomosi	176				
<b>GLOVER DEBAKEY AT</b> Pinze vascolari	159-160				
<b>GLOVER POTTS</b> Pinza per anastomose	175				
<b>GLOVER POTTS</b> Pinza vascolare	160				
<b>GLUCK</b> Costotomo	259				
<b>GORNEY</b> Forbici vascolari	27				
<b>GORNEY FREEMAN</b> Forbici vascolari	28				
<b>GRAEFE ADSON</b> Pinza chirurgica	43				
<b>GREENBERG PAR</b>					
Forbici per preparazione	12				
<b>GREGORY AT</b> Pinze vascolari	157				
<b>GREGORY DIETHRICH</b>					
Forbice vascolare	32				
<b>GREGORY</b> Pinze Bulldog	127				



<b>H</b>			<b>JOHNS HOPKINS</b> Pinze Bulldog 124			<b>LOCKLIN</b> Forbice per tessuto 23		
<b>HAIGHT BABY</b>			<b>JONES LELAND AT</b>			<b>LOVE (MORSE)</b> Uncini e divaricatori per vasi 212		
Divaricatori costali e sternali 281			Pinze emostatica periferica 177			<b>LOVELACE DIXON</b> Pinza emostatica 133		
<b>HAIGHT FINOCHIETTO BABY</b>			<b>JULIAN HM</b> Port'aghi 84			<b>LOVELACE</b> Pinza emostatica 133		
Divaricatori costali e sternali 279			<b>K</b>			<b>LUCAE</b> Uncinetti vascolari 206		
<b>HAIMOVICI</b> Forbici vascolari 25			<b>KADER</b> Divaricatori e spatole per polmoni 227			<b>LUER STILLE</b> Pinze-sgorbie 248		
<b>HALLE</b> Spatola vascolare 80			<b>KAY LAMBERT AT</b> Pinza per aorta 191			<b>M</b>		
<b>HALSEY HM</b> Port'aghi 83			<b>KELLY</b> Divaricatore 219			<b>MAGIC CUT</b> Forbici 9-10, 12, 14-18, 20-21, 27-28, 31, 33		
<b>HALSTED (ADSON)</b> Pinze emostatiche 138			<b>KELLY</b> Forbici delicate 10			<b>MARBERGER</b> Uncini e divaricatori per vasi 210		
<b>HALSTED MICRO</b> Pinze emostatiche 128			<b>KEY LISTON</b> Pinza ossivora 254			<b>MASSON HM</b> Port'aghi 88		
<b>HALSTED MOSQUITO</b> Pinze emostatiche 130			<b>KILNER RAGNELL</b> Forbici per preparazione 13			<b>MATHIEU HM</b> Port'aghi 90		
<b>HARKEN DEBAKEY AT</b> Pinze per vena cava 188			<b>KLINKENBERGH</b> Forbice vascolare 24			<b>MATHIEU RYDER MICRO HM</b> Port'aghi 90		
<b>HARKEN NISSEN</b>			<b>KOCHER ALLEN</b> Pinze emostatiche 132			<b>MATSON</b> Periostotomo 244		
Divaricatore costali e sternali 284			<b>KOCHER BABY</b> Pinze emostatiche 128			<b>MAYO HEGAR HM</b> Port'aghi 83		
<b>HARRINGTON BABY</b>			<b>KOCHER LANGENBECK</b> Divaricatori 216			<b>MAYO</b> Pinza per afferrare tessuto 57		
Divaricatore e spatola per polmone 221			<b>KOCHER</b> Pinze emostatiche 133			<b>MAYO</b> Strumenti per varici 74		
<b>HARRINGTON</b>			<b>KOCHER ROCHESTER OCHSNER</b>			<b>MCINDOE</b> Pinza anatomica 45		
Divaricatori e spatole per polmoni 221			Pinze emostatiche 136			<b>MCINDOE</b> Pinze ossivore 253		
<b>HARRINGTON PEMBERTON</b>			<b>KOENIG</b> Uncini e divaricatori per vasi 209			<b>MEDICON ANKENEY</b>		
Divaricatore e spatola per polmone 222			<b>KOSHIMA CASTROVIEJO</b> Micro port'aghi 91			Divaricatori costali e sternali 277-278		
<b>HEANEY HM</b> Port'aghi 87			<b>KOSHIMA</b> Forbici micro 35			<b>MEDICON</b> Divaricatore per costali 264		
<b>HEGAR CORWIN</b> Pinza tenda fili d'acciaio 104			<b>KOSHIMA JACOBSON ADSON</b> Micro pinza 60			<b>MEDICON</b> Divaricatori autostatici 236		
<b>HEGAR MAYO HM</b> Port'aghi 83			<b>KOSHIMA MICRO JACOBSON</b>			<b>MEDICON FINOCHIETTO</b>		
<b>HEGEMANN DIETRICH</b> Forbici vascolari 31			Pinze emostatiche 129			Divaricatori costali e sternali 280		
<b>HEISS</b> Pinze emostatiche 139, 142			<b>KOSHIMA</b> Micro pinze 60			<b>MEDICON HM</b> Pinza tenda fili d'acciaio 102		
<b>HENLY AT</b> Pinza per arteria sottoclavicale 165			<b>KRAYENBUEHL</b> Uncinetti vascolari 207			<b>MEDICON IMA</b> Divaricatore 266-267		
<b>HM</b> Forbici 9-10, 12-20, 27-29, 33			<b>L</b>			<b>MEDICON MORSE STERNAL</b>		
<b>HOEPFNER</b> Pinza vascolare 159			<b>LAHEY</b> Divaricatori 213			Divaricatori costali e sternali 270		
<b>HOPKINS JOHNS</b> Pinze Bulldog 124			<b>LAHEY</b>			<b>MEDICON PACKER (SKILLMAN)</b>		
<b>HOPT AT</b> Pinze per arteria renale 182			Pinze per preparazione e per legatura 145, 147			Pinze emostatiche 130		
<b>HUSFELDT DEBAKEY AT</b> Pinze carotis 166-167			<b>LAHEY SWEET</b>			<b>MEDICON</b> Pinza tenda fili d'acciaio 102		
			Pinza per preparazione e per legatura 148			<b>MEEKER</b> Pinza emostatica 140		
			<b>LAMBERT KAY AT</b> Pinza per aorta 191			<b>MEHDORN</b> Micro clips vascolari 115		
			<b>LAMBOTTE</b> Periostotomi 242			<b>MERZ</b> Perforatore per aorta 304		
			<b>LANGENBECK</b> Divaricatori 213-215			<b>METZENBAUM BABY</b>		
			<b>LANGENBECK HM</b> Port'aghi 90			Forbici per preparazione 14		
			<b>LANGENBECK KOCHER</b> Divaricatori 216			<b>METZENBAUM</b> Forbici per preparazione 15-16		
			<b>LANGENBECK</b> Periostotomo 242			<b>METZENBAUM SLIM</b>		
			<b>LANGENBECK</b> Tenaglia per ossa 257			Forbici per preparazione 19-21		
			<b>LEBSCHKE</b> Scalpello per sterno 296			<b>MICRO 2000 (KOSHIMA)</b> Micro pinza 60		
			<b>LEES AT</b> Pinze per bronchi 153			<b>MICRO 2000</b> Forbici micro 34-36		
			<b>LEKSELL</b> Pinze-sgorbie 250			<b>MICRO 2000</b> Pinze micro 60-63		
			<b>LELAND JONES AT</b>			<b>MICRO 2000</b> Port'aghi micro 95-97		
			Pinze emostatiche per vasi periferici 177			<b>MICRO ADSON</b> Pinza anatomica 43		
			<b>LEMMON</b> Spatole vascolari 78			<b>MICRO ADSON</b> Pinza chirurgica 43		
			<b>LEMOLE AT</b> Pinze per aorta 166			<b>MICRO CASTROVIEJO</b> Micro port'aghi 91		
			<b>LERICHE</b> Pinze emostatiche 131			Micro clip vascolari 107-109, 111-115		
			<b>LICHTENBERG HM</b> Port'aghi 90			Micro forbici 33-39		
			<b>LISTON KEY</b> Pinza ossivora 254			<b>MICRO HALSTED</b> Pinze emostatiche 128		
			<b>LISTON</b> Pinze ossivore 252			<b>MICRO JACOBSON (KOSHIMA)</b>		
			<b>LISTON RUSKIN</b> Pinze ossivore 253			Pinze emostatiche 129		
			<b>LISTON STILLE</b> Pinze ossivore 254			<b>MICRO JACOBSON</b> Pinze emostatiche 138		
			<b>LITTAUER</b> Pinza ossivora 253			Micro pinze 58-64		
						Micro pinze in titanio 58		
						Micro pinze per annodare fili 64		
<b>I</b>								
<b>IMA</b> Divaricatori 265-267								
<b>INFANT FINOCHIETTO</b>								
Divaricatori costali e sternali 279								
<b>INTRACARDIAC HM</b> Port'aghi 85								
<b>J</b>								
<b>JACOBSON ADSON (KOSHIMA)</b>								
Micro pinza 60								
<b>JACOBSON ADSON</b> Micro pinza 59								
<b>JACOBSON</b> Forbice micro 39								
<b>JACOBSON HM</b> Micro port'aghi 92								
<b>JACOBSON MICRO (KOSHIMA)</b>								
Pinze emostatiche 129								
<b>JACOBSON MICRO 2000</b> Forbici micro 35								
<b>JACOBSON</b> Micro pinze 59								
<b>JACOBSON MICRO</b> Pinze emostatiche 138								
<b>JACOBSON</b> Micro port'aghi 92								
<b>JACOBSON</b> Uncino fino 208								
<b>JAMESON REYNOLDS</b>								
Forbici per preparazione 21								
<b>JAVID</b> Pinze carotis 167								



Micro port'aghi	91-97	<b>OVERHOLT MIOTTI</b>		Pinze per catetere	197
Micro port'aghi in titanio	94	Pinze per preparazione e per legatura	144	Pinze per coarctazione	172-173
<b>MICRO SLIM HM</b> Port'aghi	85	<b>OVERHOLT MIXTER</b>		Pinze per diversi applicazioni	156-163
<b>MICROVASCULAR HM</b> Port'aghi	86	Pinza per preparazione e per legatura	146	Pinze per legatura	143-150, 184-185
<b>MIKULICZ</b> Divaricatore	219-220	<b>OVERHOLT SLIM</b>		Pinze per occlusione tangenziale	168
<b>MILLES</b> Forbici micro	39	Pinze per preparazione e per legatura	144	Pinze per patent ductus	170-171
<b>MILLS</b> Forbice vascolare	32	<b>P</b>		Pinze per preparazione	143-150
<b>MINI RYDER HM</b> Port'aghi	85			Pinze per sutura	61, 63-64
<b>MIOTTI OVERHOLT</b>				pinza per vari applicazioni	156-163
Pinze per preparazione e per legatura	144	<b>PACKER MEDICON (SKILLMAN)</b>		Pinze per vena cava	186-188
<b>MIXTER BABY</b>		Pinze emostatiche	130	Pinze per vena iliaca	169
Pinze per preparazione e per legatura	145	<b>PEAN AT</b> Pinze emostatiche	135	Pinze tenda fili d'acciaio	102-104
<b>MIXTER CRAFOORD</b>		<b>PEAN BABY</b> Pinze emostatiche	128	Pinze vascolari	48-55, 155-197
Pinze per preparazione e per legatura	148	<b>PEAN DEBAKEY AT</b> Pinze emostatiche	135	Pinze-sgorbie	247-251
<b>MIXTER OVERHOLT</b>		<b>PEAN</b> Pinze emostatiche	133	Port'aghi	82-97
Pinza per preparazione e per legatura	146	<b>PEAN ROCHESTER</b> Pinze emostatiche	134	Port'aghi HM	83-92
<b>MIXTER</b>		<b>PEMBERTON HARRINGTON</b>	222	Port'aghi HM spiegazioni	82
Pinze per preparazione e per legatura	145, 149	Divaricatore e spatola per polmone		Port'aghi micro	91-97
<b>MOLDESTAD</b> Uncinetto vascolare	206	Perforatori per aorta	304	<b>POTTS DEMARTEL</b> Forbice vascolare	32
<b>MORSE FAVALORO STERNAL</b>		Periostotomi	242-246	<b>POTTS GLOVER</b>	
Divaricatori costali e sternali	269	<b>PERWIZSCHKY</b> Forbice vascolare	24	Pinza per anastomose	175
<b>MORSE LOVE</b> Uncini e divaricatori per vasi	212	<b>PETERSEN SMITH</b> Pinze-sgorbie	248	<b>POTTS GLOVER</b> Pinza vascolare	160
<b>MORSE MEDICON STERNAL</b>		Pinza per applicare le pinze Bulldog	125	<b>POTTS</b> Pinze per coarctazione	172
Divaricatori costali e sternali	270	Pinza per arteria sottoclavicale	165	<b>POTTS</b> Pinze per patent ductus	170
<b>MORSE STERNAL</b>		Pinza per auricola	169	<b>POTTS SATINSKY</b>	
Divaricatori costali e sternali	268	Pinze	42-64, 120-197	Pinza per anastomose	175
<b>MOSQUITO AT</b> Pinze emostatiche	129	Pinze anatomiche	42-46	<b>POTTS SATINSKY</b>	
<b>MOSQUITO HALSTED</b> Pinze emostatiche	130	Pinze atraumatiche	47-55, 120-121, 125-127, 129, 132, 135, 153-185, 187-196	Pinze per vena cava	187
<b>MUELLER</b> Approssimatori	114	Pinze atraumatiche in titanio	53-55	<b>POTTS SMITH</b> Forbici vascolari	26, 30
<b>MUELLER</b> Clips vascolari	116	Pinze Bulldog	120-127, 155	<b>POTTS SMITH HM</b> Pinze anatomiche	42
<b>MUELLER</b> Micro clips vascolari	114	Pinze Bulldog atraumatiche	120-121, 125-127	<b>POTTS SMITH</b> Pinze anatomiche	45
<b>MYERS</b> Strumenti per varici	74	Pinze Bulldog in titanio	120-121	<b>POTTS SMITH</b> Pinze chirurgiche	45
		Pinze carotis	166-167	<b>POTTS YASARGIL</b> Forbice micro	39
		Pinze chirurgiche	43-46	<b>PRICE THOMAS</b> Pinze per bronchi	151
		Pinze delicate	43-45	Proposte di sets	308-318
		Pinze emostatiche per vasi periferici	177-180	<b>PYNCHON ANDREWS</b>	
		Pinze emostatiche	128-142	Strumento per aspirazione	67
		Pinze emostatiche in titanio	130-131		
		Pinze in titanio	120-121, 130-131		
		Pinze micro	58-64		
		Pinze neonatali	192-196	<b>R</b>	
		Pinze ossivore	252-254	<b>RAGNELL (KILNER)</b>	
		Pinze per afferrare	200-204	Forbici per preparazione	13
		Pinze per afferrare tessuti	56-57, 200-204	<b>REYNOLDS (JAMESON)</b>	
		Pinze per afferrare tessuti HM	200, 203	Forbici per preparazione	21
		Pinze per anastomosi	174-176	<b>RIENHOFF FINOCHIETTO</b>	
		Pinze per aneurisma d'aorta	183-184	Divaricatore costali e sternali	281
		Pinze per annodare fili	64	<b>ROCHESTER OCHSNER KOCHER</b>	
		Pinze per aorta	166, 189-191	Pinze emostatiche	136
		Pinze per aorta addominale	164-165	<b>ROCHESTER PEAN</b> Pinze emostatiche	134
		Pinze per applicare clip	106, 110-111, 113-115, 117	<b>ROSS</b> Divaricatori per aorta	234
		Pinze per applicare clip		<b>RUMEL BELMONT</b> Compressori	298
		per clip in titanio	106	<b>RUSKIN LISTON</b> Pinze ossivore	253
		Pinze per arteria renale	181-182	<b>RYDER (FRENCH EYE) HM</b>	
		Pinze per bronchi	151-154	Port'aghi	85
				<b>RYDER MATHIEU MICRO</b>	
				HM Port'aghi	90
				<b>RYDER MINI HM</b> Port'aghi	85
				<b>RYDER SLIM HM</b> Port'aghi	86

**S**

<b>SACHS</b> Spatola vascolare	78
<b>SAROT HM</b> Port'aghi	84
<b>SAROT</b> Pinze emostatiche	137
<b>SAROT</b> Pinze per bronchi	152
<b>SATINSKY BABY</b> Pinza per vena cava	186
<b>SATINSKY DEBAKEY AT</b> Pinze per vena cava	187
<b>SATINSKY</b> Forbici vascolari	24, 26
<b>SATINSKY</b> Pinze per vena cava	186
<b>SATINSKY POTTS</b> Pinza per anastomose	175
<b>SATINSKY POTTS</b> Pinze per vena cava	187
<b>SAUERBRUCH</b> Costotomo	260
<b>SAUERBRUCH</b> Divaricatore	217
Scalpello per sterno	296
<b>SCHMID</b> Cannule di lavaggio per vasi	76
<b>SCHMID</b> Spatole vascolari	78
<b>SCHOENBORN</b> Divaricatori	213
<b>SCHWARTZ</b> Clips vascolari	117
<b>SCHWARTZ</b> Pinza per applicare clip	117
<b>SELECT</b> Pinze anatomiche	44
<b>SELECT</b> Pinze chirurgiche	44
<b>SELLORS CRAFOORD</b> Pinze emostatiche	137
<b>SELLORS</b> Divaricatore costali	264
<b>SEMB DEBAKEY AT</b> Pinza per legatura	185
<b>SEMB</b> Periostotomi	243
<b>SEMB</b> Pinze per preparazione e per legatura	150
<b>SEMB STILLE</b> Pinze-sgorbie	249
<b>SEMB</b> Tenaglie per ossa	257
<b>SEMB</b> Divaricatori per polmoni	229
<b>SEMKEN</b> Pinze chirurgiche	44
<b>SENNING HM</b> Port'aghi	88
<b>SENNING</b> Port'aghi	88
Set per tunnelizzazione	302-303
Sets di sonde per varici	72-73
<b>SIEGERT</b> Forbici delicate	10
<b>SKILLMAN MEDICON PACKER</b> Pinze emostatiche	130
<b>SLIM</b> Forbici per preparazione	14
<b>SLIM METZENBAUM</b> Forbici per preparazione	19-21
<b>SLIM MICRO HM</b> Port'aghi	85
<b>SLIM OVERHOLT</b> Pinze per preparazione e per legatura	144
<b>SLIM RYDER HM</b> Port'aghi	86
<b>SMITH PETERSEN</b> Pinze-sgorbie	248
<b>SMITH POTTS</b> Forbici vascolari	26, 30
<b>SMITH POTTS HM</b> Pinze anatomiche	42
<b>SMITH POTTS</b> Pinze anatomiche	45
<b>SMITH POTTS</b> Pinze chirurgiche	45
Spatole per polmoni	221-228
Spatole vascolari	78-80
<b>STERNAL CASTANEDA</b> Divaricatori costali e sternali	283
<b>STERNAL MEDICON MORSE</b> Divaricatori costali e sternali	270
<b>STERNAL MORSE</b> Divaricatori costali e sternali	268

**STERNAL MORSE FAVALORO**

Divaricatori costali e sternali	269
<b>STEVENS</b> Forbici delicate	9
<b>STILLE LISTON</b> Pinze ossivore	254
<b>STILLE LUER</b> Pinze-sgorbie	248
<b>STILLE</b> Pinza-sgorbia	249
<b>STILLE SEMB</b> Pinze-sgorbie	249
<b>STRATTE HM</b> Port'aghi	87
<b>STRUCK</b> Divaricatori costali e sternali	275
<b>STRULLY</b> Forbice vascolare	27
Strumenti d'aspirazione	66-69
Strumenti per endarterectomia	75
Strumenti per fili d'acciaio	100-104
Strumenti per varici	72-74
Strumenti per vene	73
<b>SUBRAMANIAN DEBAKEY AT</b> Pinza neonatale	195
<b>SUBRAMANIAN</b> Pinze neonatali	195
<b>SUPERCUT</b> Forbici	9-10, 12-21, 27-28, 30-31, 36-37
<b>SUPERCUT PLUS</b> Forbici	9-10, 12-20
<b>SWEET LAHEY</b> Pinza per preparazione e per legatura	148
<b>SYPERT</b> Pinza-sgorbia	251

**T**

Tenaglie per ossa	256-257
Tenaglie piatte	103
Tenaglie tagliafilii	100-101
Tenaglie tagliafilii HM	100-101
<b>THOMAS PRICE</b> Pinze per bronchi	151
Titanio Bulldog pinze	120-121
Titanio clips vascolari	106
Titanio forbici micro	38
Titanio micro pinze	58
Titanio micro port'aghi	94
Titanio pinze	120-121, 130-131
Titanio pinze atraumatiche	53-55
Titanio pinze emostatiche	130-131
<b>TOENNIS HM</b> Port'aghi	90
<b>TOENNIS</b> Spatole vascolari	79
Tourniquets	298
<b>TUBBS</b> Dilatatore per l'aorta	299
<b>TUFFIER</b> Divaricatori costali e sternali	288
<b>TUTTLE</b> Pinze per afferrare tessuti	56

**U**

<b>ULTRA</b> Pinze emostatiche	129
Uncinetti vascolari	206-212
Uncini fini	207-208
Uncini per nervi	206
Uncini per vene	206
<b>UNIVERSAL</b> Forbice per fili d'acciaio	100
<b>UNIVERSAL HM</b> Forbice per fili d'acciaio	100
<b>UNIVERSAL</b> Pinze tenda fili d'acciaio	103

**V**

Valvulòtomi	305
<b>VARADY</b> estrattori flebi	73
<b>VARADY</b> dissettore flebo	73
<b>VERNET GIL</b> Uncini e divaricatori per vasi	211

**W**

<b>WANGENSTEEN HM</b> Pinze per afferrare tessuti	57
<b>WANGENSTEEN HM</b> Port'aghi	89
<b>WANGENSTEEN</b> Pinze per afferrare tessuti	57
<b>WEBER AT</b> Pinze per aorta	190
<b>WEITLANER BECKMANN</b> Divaricatori autostatici	238
<b>WEITLANER</b> Divaricatori autostatici	236-237
<b>WERTHEIM BOZEMANN HM</b> Port'aghi	87
<b>WIKSTROEM</b> Pinza per preparazione e per legatura	146
<b>WILLAUER</b> Forbice polmonare	22
<b>WILLIAMS</b> Pinza per afferrare tessuto	202
<b>WOOD CRILE HM</b> Port'aghi	84
<b>WYLIE AT</b> Pinze per aorta addominale	164

**Y**

<b>YANKAUER</b> Strumenti d'aspirazione	66-67
<b>YASARGIL</b> Forbici micro	34, 39
<b>YASARGIL</b> Micro port'aghi	95, 97
<b>YASARGIL POTTS</b> Forbice micro	39

**Z**

<b>ZANGER AT</b> Pinze per aorta addominale	165
<b>ZENKER</b> Divaricatori	217



**Sterilgut-Container aus Aluminium**  
**Aluminium Containers for Sterilization**  
**Contenedores para esterilización de aluminio**  
**Containers pour la stérilisation en aluminium**  
**Contenitori per sterilizzazione in alluminio**

**MEDICONTAINER**  
**CONTAINER** *system*



Unser komplettes Medicontainer-Programm finden Sie in unserem Sonderprospekt.  
For our complete Medicontainer program please ask for our special brochure.  
Nuestro programa completo de Medicontainer se encuentra en nuestro folleto especial.  
Vous trouverez notre programme complet des Medicontainers dans notre prospectus spécial.  
Il nostro programma completo di Medicontenitori lo troverete nel prospetto speciale.



the art of surgery



**Unser Sortiment**  
**Our Product Range**  
**Nuestro programa de producción**  
**Notre gamme de produits**  
**Nostro programma di produzione**

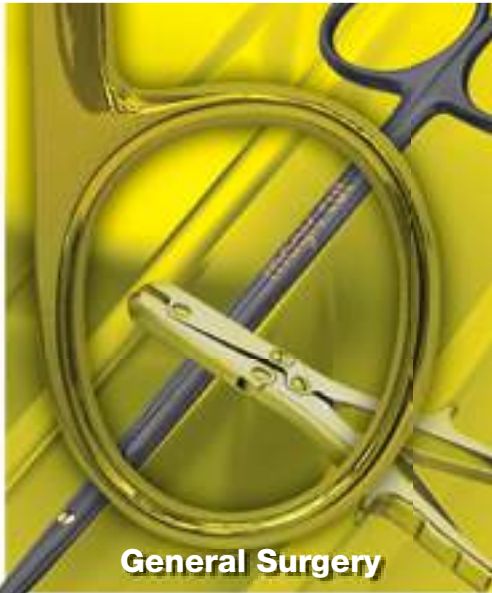

**General Surgery**

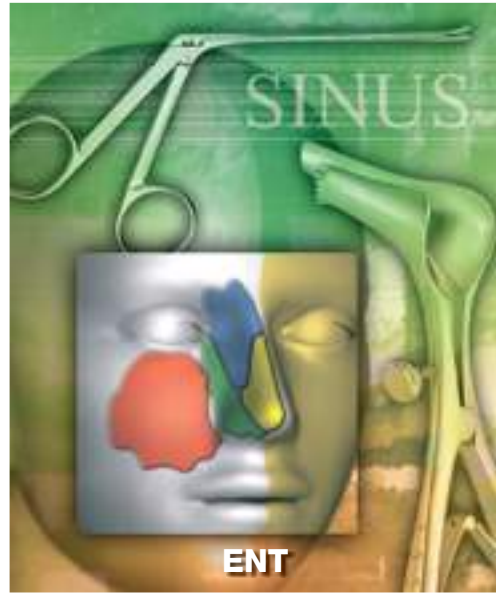

**ENT**



**Minimally Invasive Surgery**



**Plastic**



**OMF**



**Neuro / Spine**

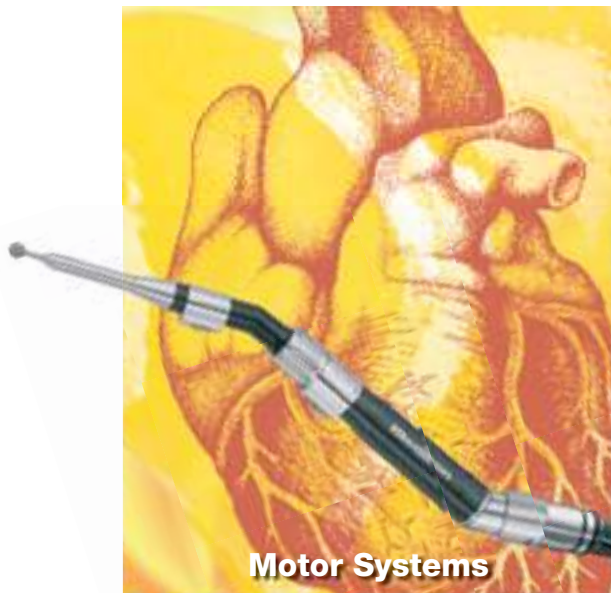

**Motor Systems**

- ■ ■ und vieles mehr.  
and much more.  
y mucho más.  
et plus encore.  
e molto di più.



**MEDICON-Gesamtprogramm**  
**Complete MEDICON Range**  
**Gama completa de MEDICON**  
**Gamme complète MEDICON**  
**Programma completo MEDICON**



Einen Überblick über das MEDICON-Gesamtprogramm finden Sie im Internet.

For general information on the complete MEDICON range please refer to the Internet.

Una vista general de la gama completa de MEDICON pueden encontrar en el Internet.

Pour une vue d'ensemble de la gamme MEDICON nous vous prions de bien vouloir vous référer sur notre site Internet.

Una visione generale della completa gamma MEDICON la trovate nell' Internet.