

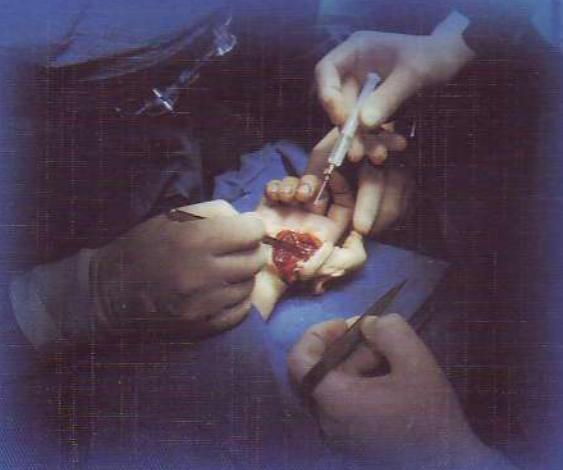

medicon
Instrumente

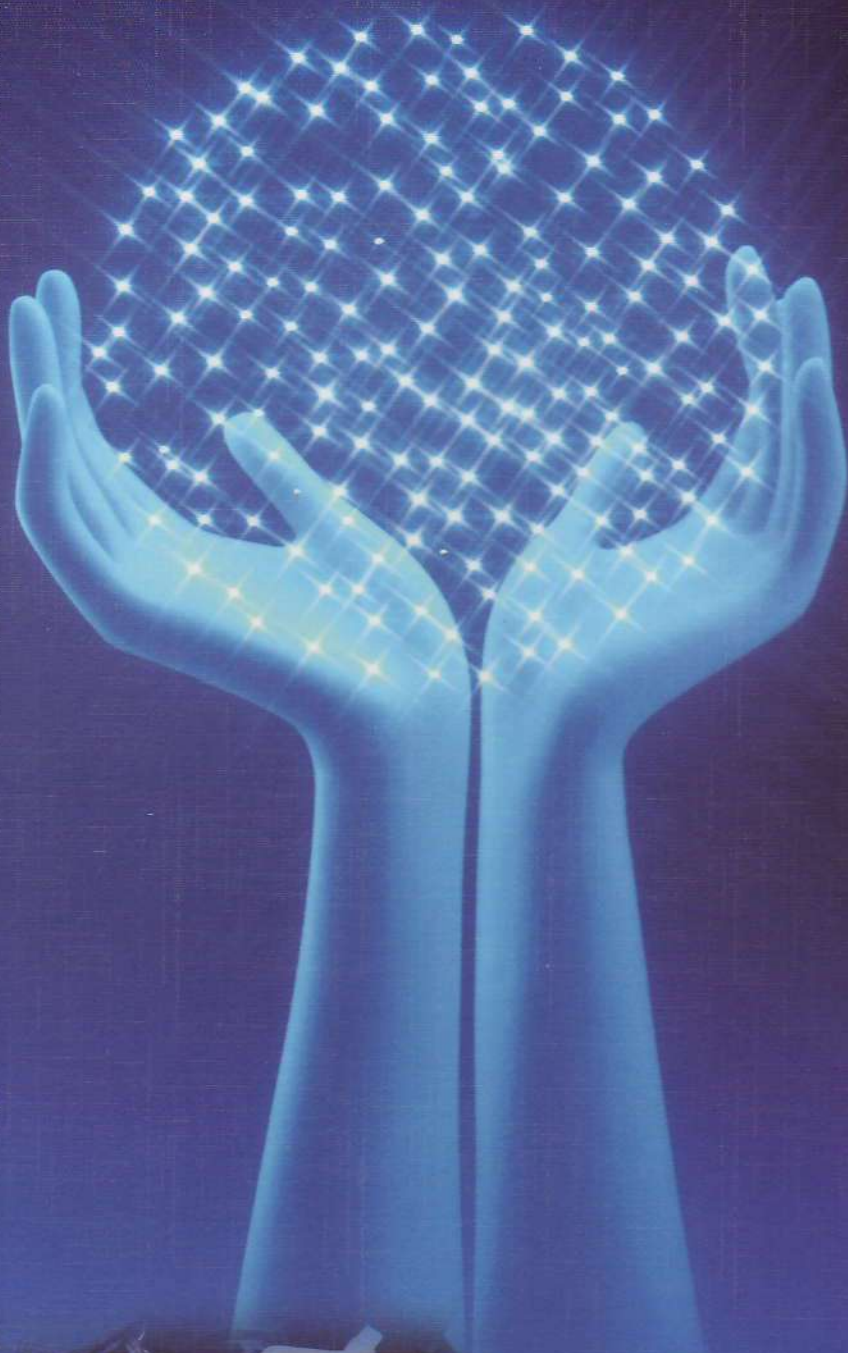

Instrumente für die Handchirurgie

Instruments for Hand Surgery
Instrumentos para cirugía de mano
Instrumentos pour la chirurgie de la main
Strumentario per la chirurgia della mano

Instrumente für die Handchirurgie
Instruments for Hand Surgery
Instrumentos para cirugía de mano
Instruments pour la chirurgie de la main
Strumentario per la chirurgia della mano

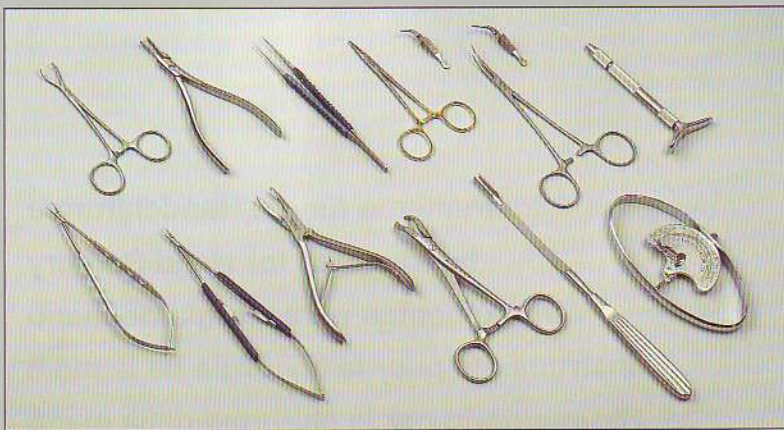

Seit über 50 Jahren haben MEDICON-Produkte durch ihre Zuverlässigkeit und Präzision weltweit Anerkennung gefunden.

Die im Verbund der MEDICON eG zusammengeschlossenen Herstellungsbetriebe mit modernsten Produktionseinrichtungen und erfahrenen Spezialisten fertigen eine umfassende Produktpalette für den Vertrieb im Inland und den Export in nahezu alle Länder der Welt. Ca. 350 Mitarbeiter in Fertigung, Vertrieb und Verwaltung bilden eine leistungsfähige Gemeinschaft. Durch die internationale Kooperation mit Chirurgen wie auch die ständige Anpassung an neue medizinische Technologien wird ein Optimum an Fortschritt und Innovation garantiert.

MEDICON products have won recognition worldwide for over 50 years thanks to their reliability and precision.

The manufacturing companies belonging to the registered MEDICON group, with their up-to-the minute production facilities and experienced specialists, offer a comprehensive range of products for sale in Germany and export to virtually every country of the world. Approx. 350 staff in production, sales and administration go to make up an efficient team. Optimal progress and innovation is guaranteed by means of international cooperation with surgeons and constant adaptation to new medical engineering techniques.

Desde hace más de 50 años, los productos de MEDICON están reconocidos en todo el mundo a razón de su fiabilidad y su precisión.

Las empresas fabricantes reunidas en la MEDICON eG, que tienen instalaciones de producción muy modernas y en las que trabajan especialistas con experiencia, fabrican una gama de productos amplia para la venta en Alemania y para la exportación a casi todos los países del mundo. Unas 350 personas empleadas en la producción, la venta y la administración están reunidas en una comunidad capaz de satisfacer todas las exigencias. La cooperación internacional con cirujanos como también la adaptación constante a nuevas tecnologías medicinales garantizan el máximo nivel con respecto a adelanto técnico e innovación.

Depuis plus de 50 ans, les produits MEDICON sont reconnus et appréciés dans le monde entier grâce à leur fiabilité et leur précision.

Les usines de fabrication regroupées dans l'association de la MEDICON eG, qui possèdent des installations de productions les plus modernes et des spécialistes ayant une grande expérience, fabriquent une palette de produits très large pour la vente en Allemagne et l'exportation dans presque tous les pays du monde. Env. 350 personnes, réparties entre la production, la vente et l'administration, représentent une communauté efficace. En raison de la coopération avec des chirurgiens ainsi qu'une adaptation continue à de nouvelles technologies médicales, nous assurons un optimum en progrès et innovation.

Da oltre 50 anni i prodotti MEDICON sono apprezzati a livello internazionale grazie alla loro affidabilità e precisione.

Le aziende produttrici associate alla MEDICON eG con gli impianti di produzione più moderni e gli specialisti più qualificati realizzano una vasta gamma di prodotti per la distribuzione in Germania e l'esportazione in quasi tutti i paesi del mondo. Circa 350 collaboratori distribuiti nei reparti di produzione, distribuzione e amministrazione formano un gruppo molto efficiente. Grazie alla cooperazione internazionale con chirurghi e all'adattamento continuo alle nuove tecnologie della medicina, viene garantito il massimo livello relativo a progresso e innovazione.

Qualitätssicherungs-System nach ISO/EN, zertifiziert durch TÜV SÜDWEST.

Ziel der Einführung und Anwendung des Qualitätssicherungs-Systems der MEDICON eG ist den anerkannt hohen Qualitätsstandard zu sichern und zu verbessern. Durch die systematische Optimierung produktionsrelevanter Techniken, Prüfverfahren und Entwicklungen erreichen wir eine Vielzahl von Vorteilen, die wir unseren Kunden weitervermitteln können.

- Modelltreue bei hohem Qualitätsniveau
- Kosten-/Nutzen-Optimierung
- Maximierung der Lieferbereitschaft
- Erfüllung internationaler Anforderungen
- Lückenloser Nachweis bei Haftungsansprüchen
- Exakte Auftragsabwicklung

Quality assurance system according to ISO/EN, certified by the TÜV (technical inspection board) for the south-west region.

The MEDICON group's quality assurance system was introduced and applied with the aim of securing and improving the recognized high standard of quality. Through systematic optimization of production-related techniques, testing procedures and developments, we achieve a number of advantages which we can then pass on to our customers.

- true-to-model accuracy with a high level of quality
- maximization of cost/benefit ratio
- optimization of delivery service
- compliance with international requirements
- complete evidence records in the event of liability claims
- accurate order processing

Sistema de aseguramiento de calidad según ISO/EN, certificado por el TÜV SÜDWEST (ITV del sudoeste de Alemania).

Para asegurar y mejorar el alto nivel de calidad reconocido, se ha introducido y aplicado el sistema de aseguramiento de calidad en la MEDICON eG. En vigor de la optimización sistemática de las técnicas importantes para la producción, de los procedimientos de ensayo y de los desarrollos, obtenemos un sinnúmero de ventajas, que ponemos a disposición de nuestros clientes.

- Exactitud de modelos a un alto nivel de calidad
- Optimización de la relación entre costes y beneficio
- Una capacidad máxima de suministro
- Cumplimiento de las exigencias internacionales
- Comprobación ininterrumpida en caso de reclamaciones de garantía
- Ejecución exacta del pedido

Système de l'assurance de la qualité selon ISO/EN, certification par le TÜV SÜDWEST.

Le but de l'introduction et de l'utilisation du système de l'assurance de la qualité de la MEDICON eG est d'assurer le standard de qualité élevé reconnu et de l'améliorer. Grâce à l'optimisation systématique de techniques importantes de production, de procédures d'essai et de développement, nous obtenons un grand nombre d'avantages que nous pouvons partager avec nos clients.

- fidélité au modèle pour un niveau élevé de qualité
- optimisation du rapport coûts/profit
- maximisation de la disponibilité de livraison
- réponse aux exigences internationales
- justification complète lors de prétentions de responsabilité
- traitement exact des commandes

Sistema di sicurezza di qualità secondo ISO/EN certificato dal TÜV SÜDWEST.

L'obiettivo dell'introduzione e dell'applicazione del sistema di sicurezza di qualità della MEDICON eG consiste nel garantire e nel migliorare l'elevato standard qualitativo. In seguito all'ottimizzazione sistematica delle tecniche di produzione, dei processi di controllo e dello sviluppo, siamo riusciti ad ottenere una serie di vantaggi che possiamo trasmettere ai nostri clienti.

- Fedeltà al modello unita ad un elevato livello qualitativo
- Ottimizzazione costi/utilità
- Massimizzazione nelle consegne
- Adempimento delle esigenze internazionali
- Prova completa in caso di diritti di responsabilità
- Esatto espletamento degli ordini

Der Ihnen vorliegende MEDICON-Katalog Nr. 8 bleibt unser Eigentum, auch wenn eine Leih- oder Schutzgebühr bezahlt wurde. Er darf nur zum Einkauf und Vertrieb der darin beschriebenen MEDICON-Produkte durch den dazu autorisierten Fachhandel und für die Bedarfsbeschaffung durch den jeweiligen Anwender verwendet werden. Seine Verwendung gegen unsere Interessen berechtigt uns zur sofortigen Rückforderung und möglichen weitergehenden Maßnahmen.

Ohne unsere ausdrückliche, schriftliche Genehmigung darf dieser Katalog weder im gesamten noch auszugsweise nachgedruckt oder kopiert werden.

This MEDICON catalogue No. 8 remains our property even if a lending fee or charge has been paid for it. It is to be used only by specialized dealers to buy and sell MEDICON products or by individual users to meet their own requirements. In case of misuse we are entitled to reclaim it immediately and to take further steps if necessary.

It is not allowed to reprint or copy this catalogue in whole or in part without our written permission.

El catálogo MEDICON No. 8 que Vd. tiene ante sí queda de nuestra propiedad hasta si hubiesen sido pagados ciertos derechos de préstamo de custodia. A los revendedores autorizados del ramo debe servir exclusivamente para la compra y la distribución de los productos MEDICON que describe y a los especialistas y usuarios particulares para escoger los instrumentos necesarios para su abastecimiento. Su empleo abusivo en perjuicio de nuestros intereses, nos da derecho a exigir su restitución inmediata y a tomar todas las medidas ulteriores que juzguemos necesarias.

Salvo nuestro permiso expreso por escrito, quedan prohibidas la reproducción tipográfica o por calcador, tanto en total como en extractos.

Le présent catalogue No. 8 de MEDICON demeure notre propriété, même après acquittement d'une taxe autorisée ou taxe de prêt. Il ne peut être utilisé que pour l'achat ou la vente des produits qui y sont décrits, par des spécialistes y étant autorisés et par l'utilisateur correspondant pour l'approvisionnement des ses besoins. Son utilisation contre nos intérêts nous autorise à une demande en restitution immédiate et à la prise éventuelle de mesures allant plus loin.

Sans autorisation formelle écrite, ce catalogue ne peut être ni réimprimé, ni copié, que ce soit complètement ou partiellement.

Il presente catalogo MEDICON No. 8 rimane di nostra proprietà anche se é stato pagato un diritto di noleggio o di proprietà riservata. Esso può essere adoperato soltanto per l'acquisto e la vendita dei prodotti MEDICON ivi descritti attraverso il commercio specializzato e autorizzato o per l'approvvigionamento tramite chi, di volta in volta, li impiega. L'uso del catalogo contro i nostri interessi ci autorizza al suo immediato ritiro e possibili ulteriori provvedimenti.

Senza la nostra esplicita autorizzazione scritta questo catalogo non può essere ristampato o copiato nè integralmente nè parzialmente.

Instrumente für die Handchirurgie Instruments for Hand Surgery Instrumentos para cirugía de mano Instruments pour la chirurgie de la main Strumentario per la chirurgia della mano	1 - 231
---	----------------

Siebvorschläge für die Handchirurgie Proposals for Hand Surgery Sets Proposiciones para sets de Cirugía de Mano Propositions de boîtes pour la chirurgie de la main Proposte di set per la chirurgia della mano	233 - 239
--	------------------

Numerisches Inhaltsverzeichnis Numerical Index Indice numérico Table des matières numérique Indice numerico	243 - 249
--	------------------

Alphabetisches Inhaltsverzeichnis	252 - 255
Alphabetical Index	256 - 259
Indice alfabético	260 - 263
Index alphabétique	264 - 267
Indice alfabetico	268 - 271

Instrumente für die Zahnheilkunde
Instrumente für die Zahnheilkunde
Instrumente für die Zahnheilkunde
Instrumente für die Zahnheilkunde
Instrumente für die Zahnheilkunde

Instrumente für die Zahnheilkunde
Instrumente für die Zahnheilkunde
Instrumente für die Zahnheilkunde
Instrumente für die Zahnheilkunde
Instrumente für die Zahnheilkunde

Instrumente für die Zahnheilkunde
Instrumente für die Zahnheilkunde
Instrumente für die Zahnheilkunde
Instrumente für die Zahnheilkunde
Instrumente für die Zahnheilkunde

Instrumente für die Zahnheilkunde
Instrumente für die Zahnheilkunde
Instrumente für die Zahnheilkunde
Instrumente für die Zahnheilkunde
Instrumente für die Zahnheilkunde

01.25.10
01.8

01.25.10
01.8

01.25.10
01.8

Medicon Instrumente
Skalpellen, Skalpellblätter,
Skalpellschneidblätter,
Skalpellschneidblätter,
Skalpellschneidblätter

**Skalpelle
Scalpels
Bisturías
Bistouris
Bisturi**



01.22.10
10



01.22.11
11



01.22.12
12



01.22.13
13



01.22.15
15



Verpackungseinheit 100 Stück, steril
Packing unit 100 pieces, sterile
Cajas con 100 piezas, estériles
Boîtes de 100 pièces, stériles
Unità di 100 pezzi, sterile

Skalpellklingen
Scalpel blades
Hojas de bisturí
Lames stériles de bistouris
Lame sterili per bisturi

Skalpellgriffe, passend für
auswechselbare Skalpellklingen
Fig. 10, 11, 12, 13, 15

Scalpel Handles for scalpel
blades fig. 10, 11, 12, 13, 15

Mangos de bisturí para
hojas intercambiables
fig. 10, 11, 12, 13, 15

Manches pour bistouris, allant
avec les lames de bistouris
interchangeables
fig. 10, 11, 12, 13, 15

Manici per bisturi, per fissare
le lame intercambiabili
fig. 10, 11, 12, 13, 15



01.27.03
no. 3



01.27.07
no. 7



01.27.17
no. 7K



01.27.40
16 cm - 6 1/4"

Scalpel handle
 Scalpel handles
 Scalpel handles for scalpel
 Manches de bistouri
 Manches de bistouri
 Manches de bistouri
 Manches de bistouri
 Manches de bistouri
 Manches de bistouri
 Manches de bistouri
 Manches de bistouri
 Manches de bistouri



01.72.10
 18 cm - 8N



01.72.10
 18 cm - 8N



01.72.10
 18 cm - 8N



01.72.10
 18 cm - 8N

mm 5,1 ad 7,1
mm 5,1 ad 7,1
mm 5,1 ad 7,1

HUMBY Dermatome
Schäufel mit
HUMBY Dermatome
Wahl für die
HUMBY Dermatome
Kopf des
HUMBY Dermatome
Kopf des
HUMBY Dermatome
Kopf des



05.11.78
35 cm - 15W
Humby

16.11.78

Produktionscode HUMBY Dermatome Nr. 05.11.78
 05.11.78
 05.11.78
 05.11.78
 05.11.78

Dermatome
Dermatomes
Dermatomo
Dermatomes
Dermatomi



67.14.30
32 cm - 12 1/2"
Humby

HUMBY Dermatom, einstellbar von 0,1 bis 1,2 mm,
Schnittbreite max. 155 mm.

HUMBY Dermatome, adjustable from 0.1 to 1.2 mm,
width of cut max. 155 mm.

HUMBY Dermatomo, regulable de 0,1 hasta 1,2 mm
ancho de corte máximo 155 mm.

HUMBY Dermatome, ajustable de 0,1 à 1,2 mm
largeur de coupe 155 mm maximum.

HUMBY Dermatomo, regolabile da mm. 0,1 a 1,2;
larghezza massima del taglio mm. 155.



67.14.31

Ersatzklinge zum HUMBY Dermatom Nr. 67.14.30
Spare Blade for HUMBY Dermatome No. 67.14.30
Hoja de repuesto para HUMBY dermatomo No. 67.14.30
Lame de rechange pour HUMBY dermatome No. 67.14.30
Lama di ricambio per HUMBY dermatomo No. 67.14.30

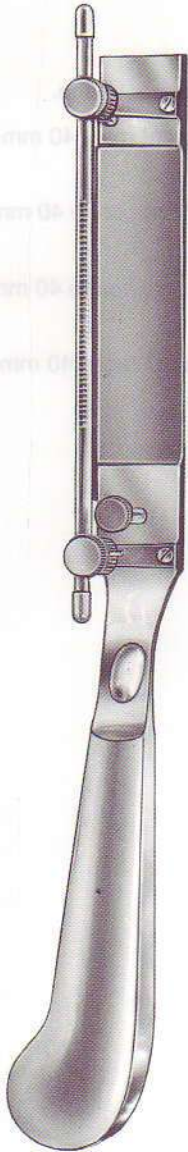

67.14.50
30 cm – 11³/₄"
Schink

SCHINK Dermatome, einstellbar von 0,1 bis 2,0 mm, Schnittbreite max. 100 mm, komplett mit 1 auswechselbaren Klinge und 2 Spannplatten.

SCHINK Dermatome, adjustable from 0.1 to 2.0 mm, width of cut max. 100 mm, complete with 1 interchangeable blade and 2 holding plates.

SCHINK Dermotomo, regulable de 0,1 hasta 2,0 mm, ancho de corte máximo 100 mm, completo con 1 hoja intercambiable y 2 placas tensoras de membrana.

SCHINK Dermatome, ajustable de 0,1 à 2,0 mm, largeur de coupe 100 mm maximum, complet avec 1 lame échangeable et 2 plaques pour tendre la peau.

SCHINK Dermatomo, regolabile da mm. 0,1 a 2,0, larghezza massima del taglio mm. 100, completo di lama intercambiabile e di 2 piastre per tendere.

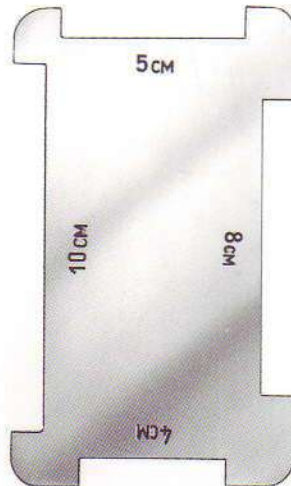

67.14.52

Haut-Spannplatte allein
Skin Holding Plate only
Placa tensora de membrana, suelta
Plaques seules, pour tendre la peau
Piastra per tendere la pelle, sola



67.14.51

Ersatzklinge zum SCHINK Dermatome Nr. 67.14.50
Spare Blade for SCHINK Dermatome No. 67.14.50
Hoja de repuesto para SCHINK dermatomo No. 67.14.50
Lame de rechange pour SCHINK dermatome No. 67.14.50
Lama di ricambio per SCHINK dermatomo No. 67.14.50



78.05.00
20 cm - 8"

Handschnittmesser, einstellbar von 0 - 2 mm,
Schnittbreite 40 mm, komplett mit auswechselbarer Klinge.

Hand knife, adjustable from 0 - 2 mm, width of cut max. 40 mm,
complete with interchangeable blade.

Cuchillo de mano, ajustable de 0 - 2 mm, ancho de corte 40 mm,
completo con hoja intercambiable.

Couteau à main, ajustable de 0 à 2 mm, largeur de coupe 40 mm,
complet avec 1 lame échangeable.

Dermatomo, regolabile da 0 - 2 mm, larghezza del taglio 40 mm,
completo con lama di ricambio.

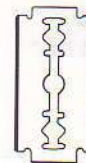

01.94.19

Ersatzklingen für Handschnittmesser 78.05.00,
Packung à 10 Stück.

Spare blades for hand knife 78.05.00,
pack of 10 pieces.

Hoja de repuesto para cuchillo de mano 78.05.00,
paquete con 10 piezas.

Lames de rechange pour couteau à main 78.05.00,
boîte de 10 pièces.

Lama di ricambio per dermatomo 78.05.00,
Pacco da 10 pezzi.



01.00.20
10,5 cm - 4 1/8"
Scheren



01.00.202
10,5 cm - 4 1/8"
Scheren



01



01.00.20
10,5 cm - 4 1/8"
Scheren

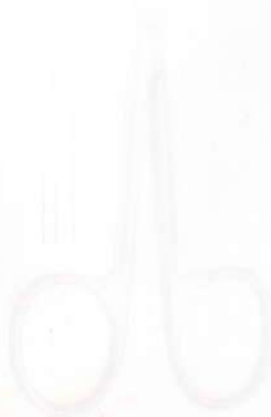

01.00.202
10,5 cm - 4 1/8"
Scheren



01.00.20
10,5 cm - 4 1/8"
Scheren

**Scheren
Scissors
Tijeras
Ciseaux
Forbici**

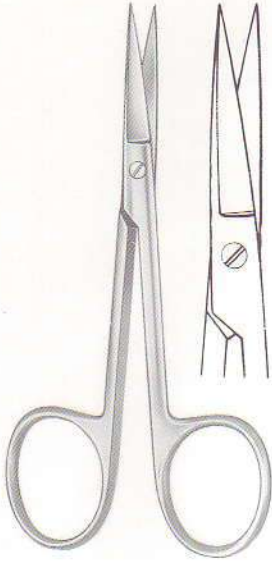

02.06.10
10,5 cm - 4¹/₈"

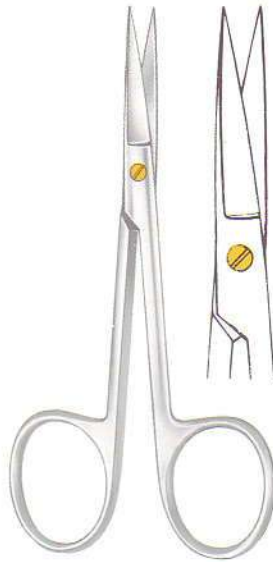

202.06.10
10,5 cm - 4¹/₈"
supercut

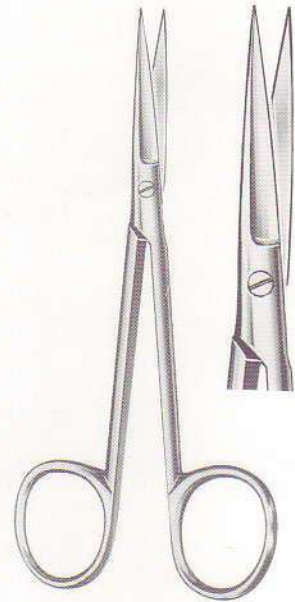

02.06.12
12 cm - 4³/₄"
Wagner

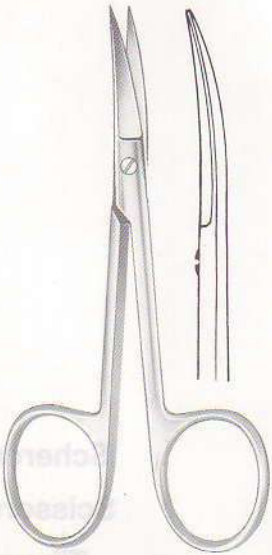

02.07.10
10,5 cm - 4¹/₈"



202.07.10
10,5 cm - 4¹/₈"
supercut

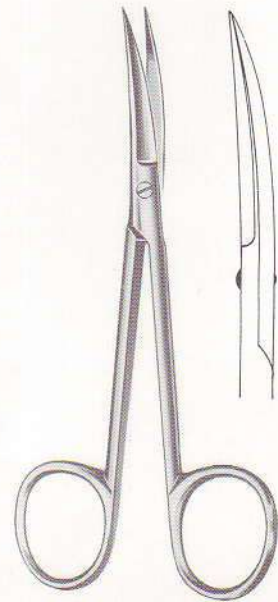

02.07.12
12 cm - 4³/₄"
Wagner

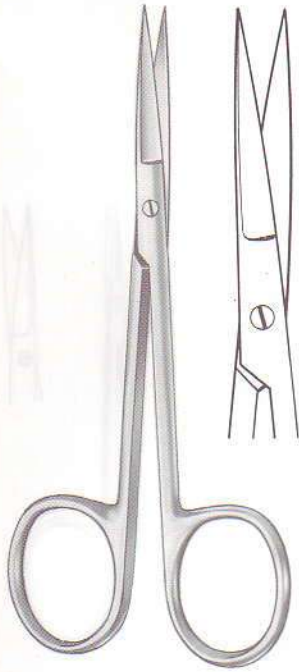

02.06.13
13 cm - 5 1/8"
Jabeley

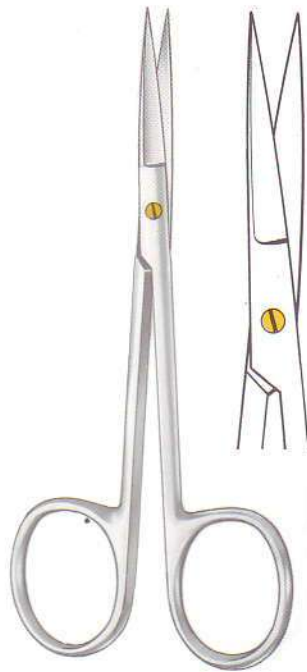

202.06.13
13 cm - 5 1/8"
Jabeley supercut

Unterminierschere
Undermining Scissors
Tijera para tunelización
Ciseau à tunnelisation
Forbici per tunnelizzare

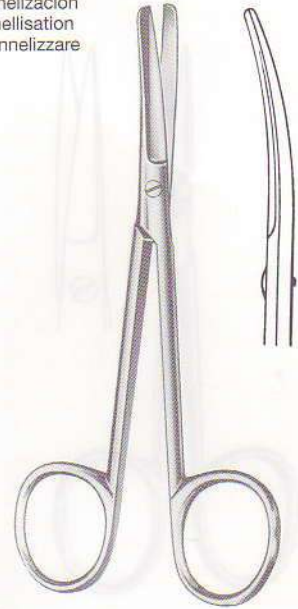

02.07.02
12 cm - 4 3/4"
Wagner

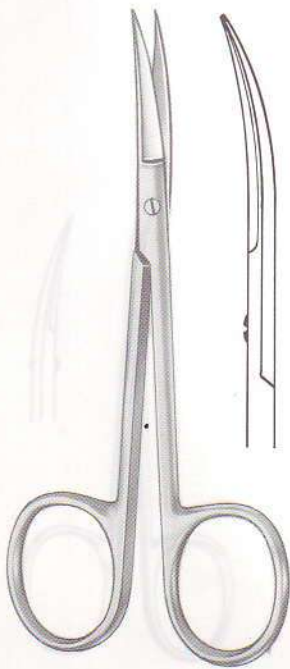

02.07.13
13 cm - 5 1/8"
Jabeley



202.07.13
13 cm - 5 1/8"
Jabeley supercut

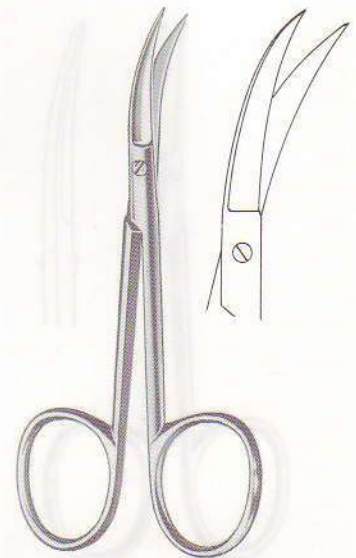

02.07.80
10,5 cm - 4 1/8"

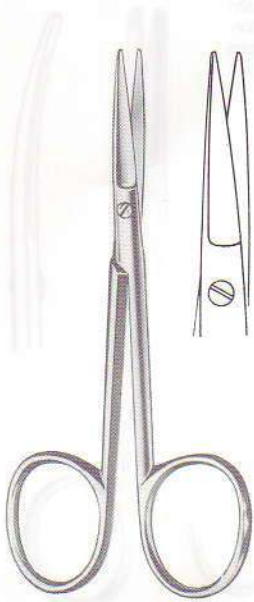

02.10.10
 10,5 cm - 4¹/₈"

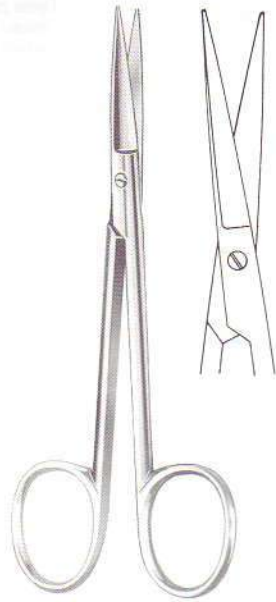

02.10.12
 12 cm - 4³/₄"



02.20.09
 9 cm - 3¹/₂"
Iris Standard

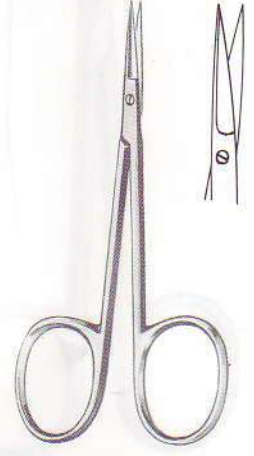

02.20.30
 9 cm - 3¹/₂"
Micro-Iris

Unterminierschere
 Undermining Scissors
 Tijera para tunelización
 Ciseau à tunnelisation
 Forbici per tunnelizzare

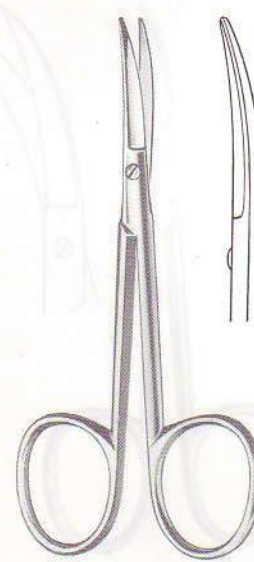

02.11.10
 10,5 cm - 4¹/₈"

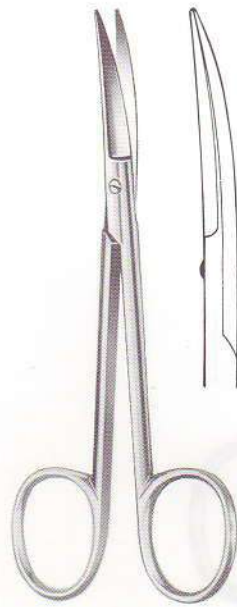

02.11.12
 12 cm - 4³/₄"



02.21.09
 9 cm - 3¹/₂"
Iris Standard

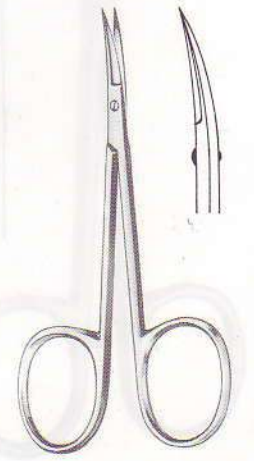

02.21.30
 9 cm - 3¹/₂"
Micro-Iris

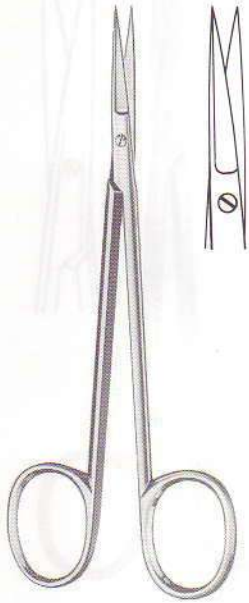

02.20.42
 12 cm - 4³/₄"
Knapp

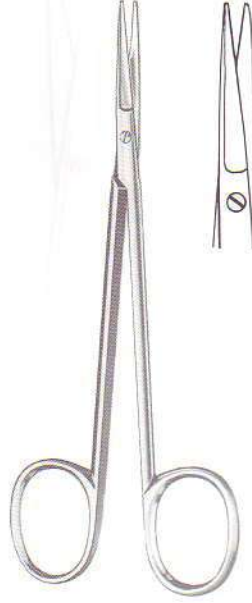

02.20.43
 12 cm - 4³/₄"
Knapp



02.20.61
 11,5 cm - 4¹/₂"
Iris "HM"

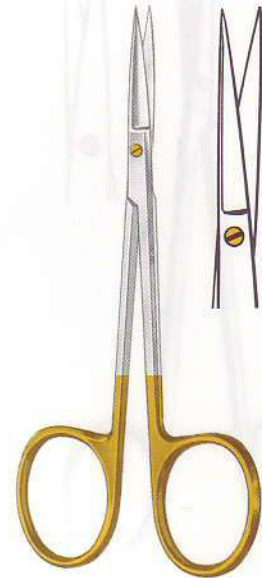

202.20.61
 11,5 cm - 4¹/₂"
Iris supercut plus

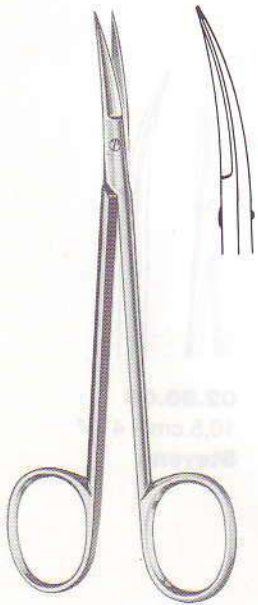

02.21.42
 12 cm - 4³/₄"
Knapp

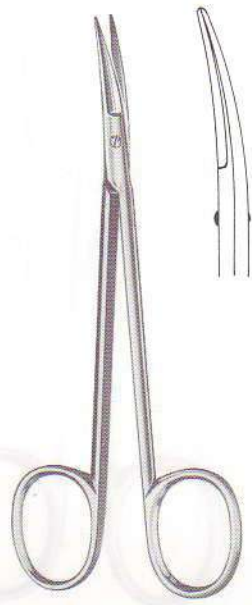

02.21.43
 12 cm - 4³/₄"
Knapp

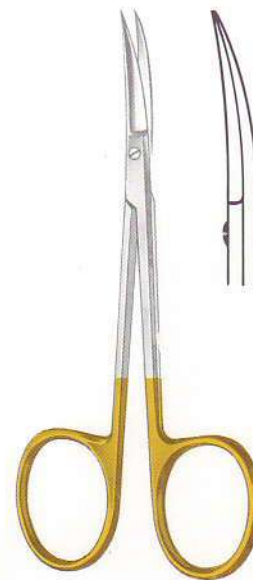

02.21.61
 11,5 cm - 4¹/₂"
Iris "HM"

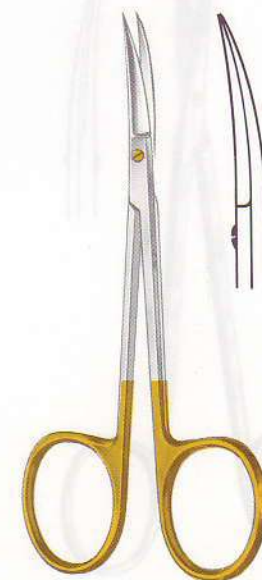

202.21.61
 11,5 cm - 4¹/₂"
Iris supercut plus

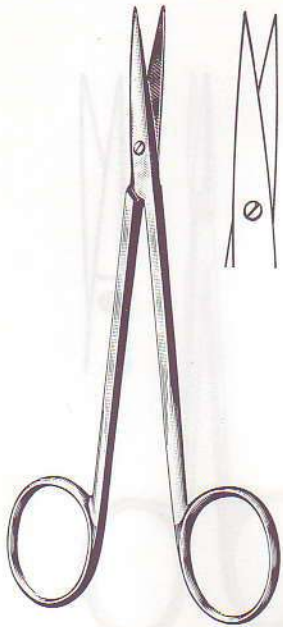

02.26.12
 12 cm - 4³/₄"

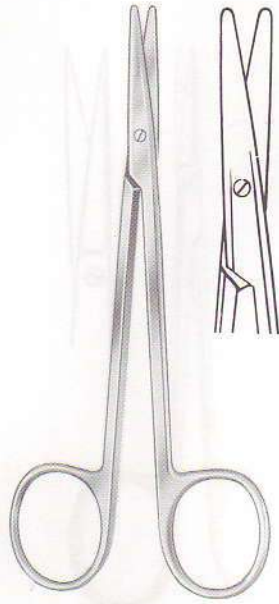

02.40.12
 12 cm - 4³/₄"

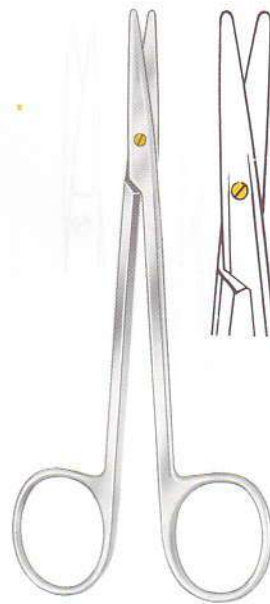

202.40.12
 12 cm - 4³/₄"
supercut

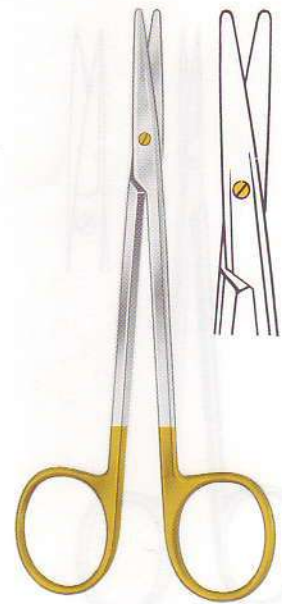

202.40.62
 12 cm - 4³/₄"
supercut plus

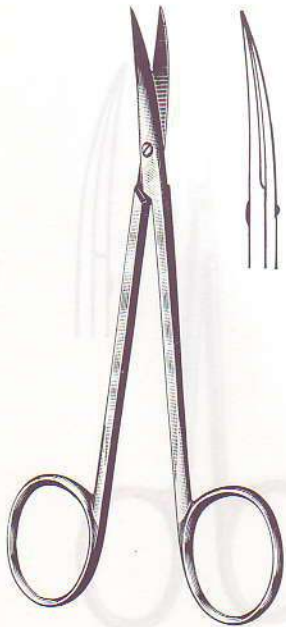

02.27.12
 12 cm - 4³/₄"

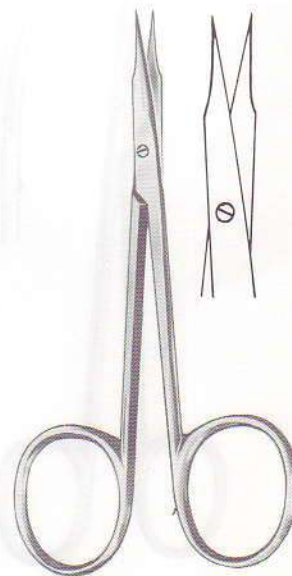

02.50.02
 10,5 cm - 4¹/₈"
Stevens

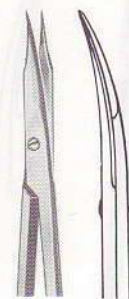

02.50.03
 10,5 cm - 4¹/₈"
Stevens

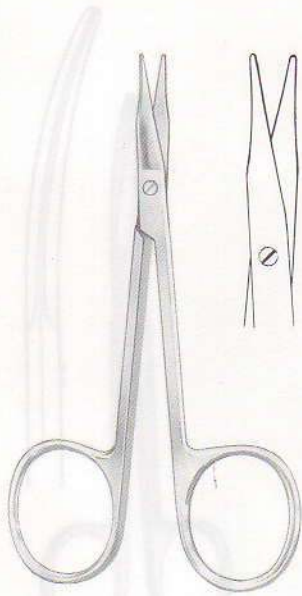

02.50.12
10,5 cm - 4¹/₈"
Stevens

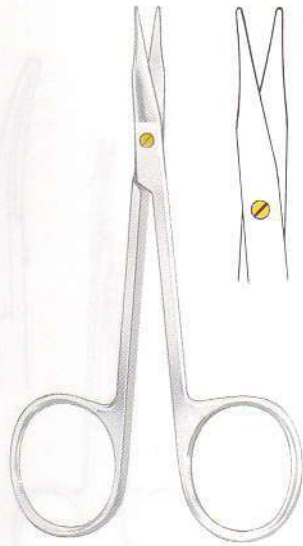

202.50.12
10,5 cm - 4¹/₈"
Stevens supercut

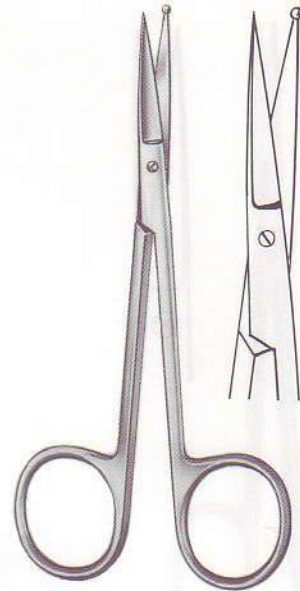

02.50.52
11,5 cm

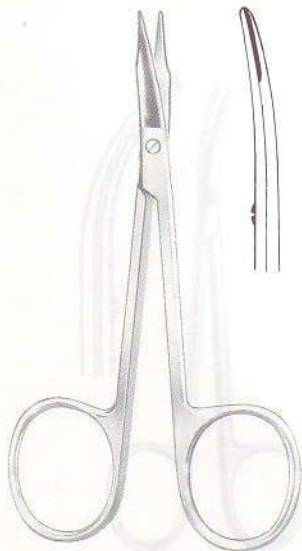

02.50.13
10,5 cm - 4¹/₈"
Stevens



202.50.13
10,5 cm - 4¹/₈"
Stevens supercut

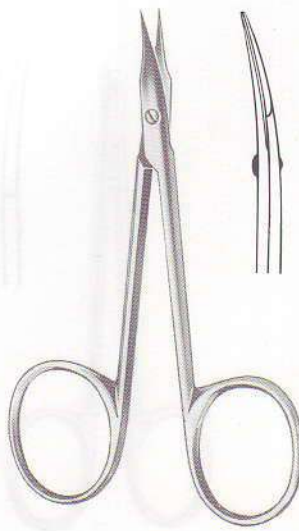

02.50.43
10 cm - 4"

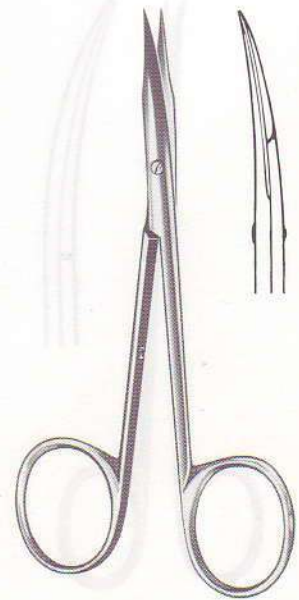

02.50.45
12,5 cm - 5"

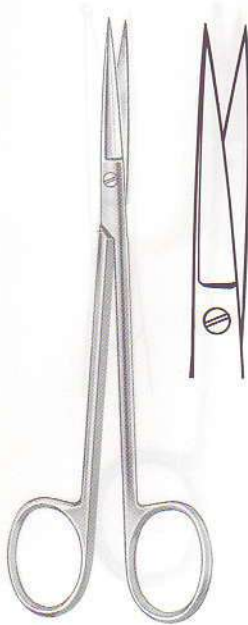

04.50.15
 15 cm - 6"
Joseph

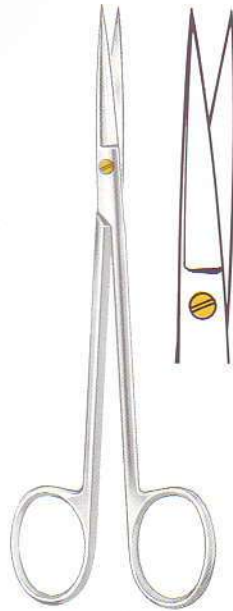

204.50.15
 15 cm - 6"
Joseph supercut

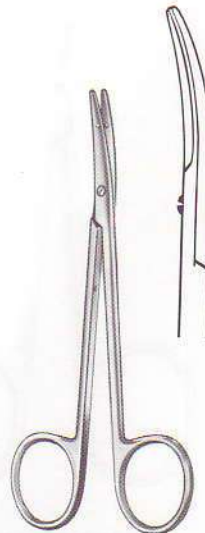

67.50.01
 12 cm - 4 3/4"
Littler



67.51.14
 14 cm - 5 1/2"
Aufricht

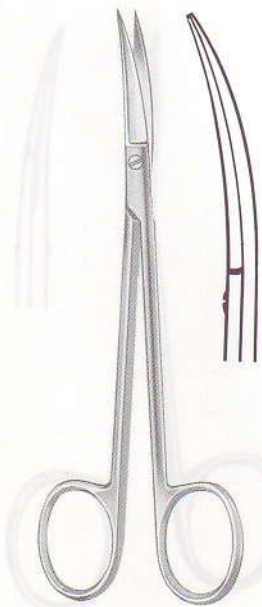

04.51.15
 15 cm - 6"
Joseph

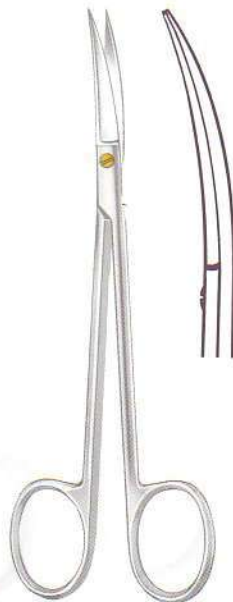

204.51.15
 15 cm - 6"
Joseph supercut



67.52.12
 12,5 cm - 5"
Fomon

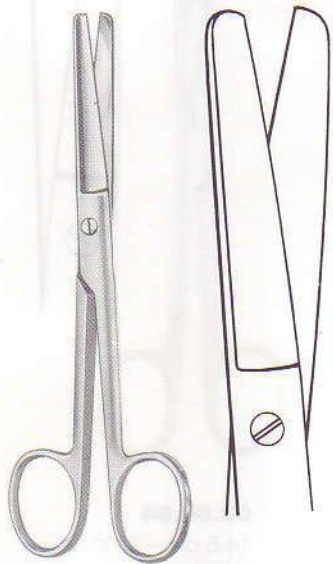

03.02.14
14,5 cm - 5³/₄"

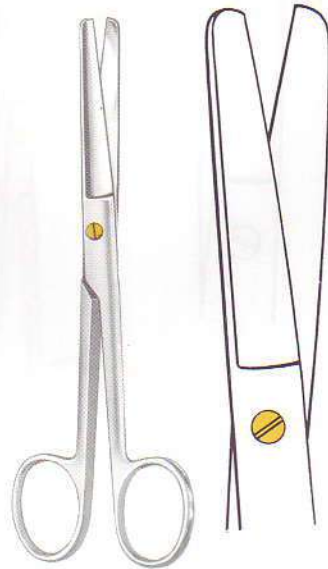

203.02.14
14,5 cm - 5³/₄"
supercut

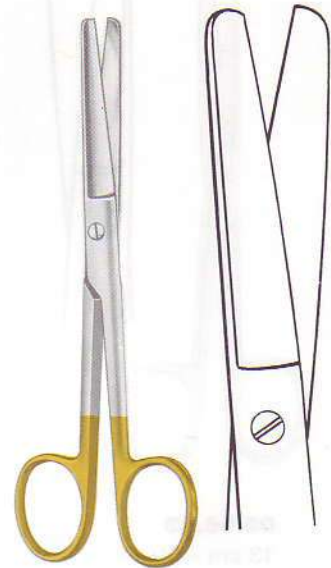

03.02.64
14,5 cm - 5³/₄"
"HM"

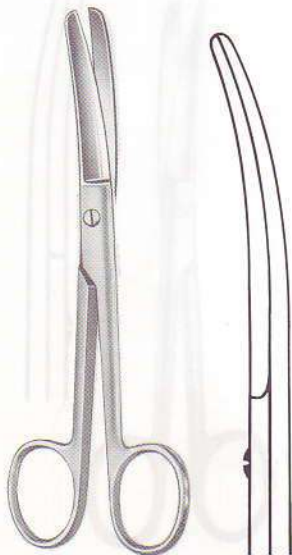

03.03.14
14,5 cm - 5³/₄"



203.03.14
14,5 cm - 5³/₄"
supercut



03.03.64
14,5 cm - 5³/₄"
"HM"

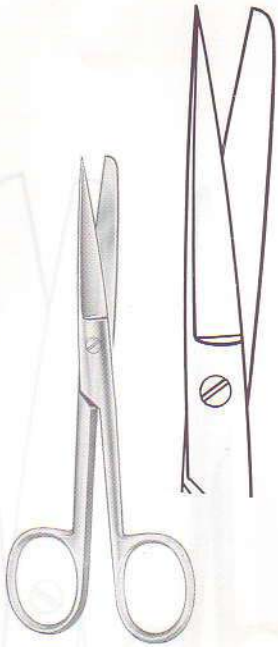

03.06.13
 13 cm - 5¹/₈"

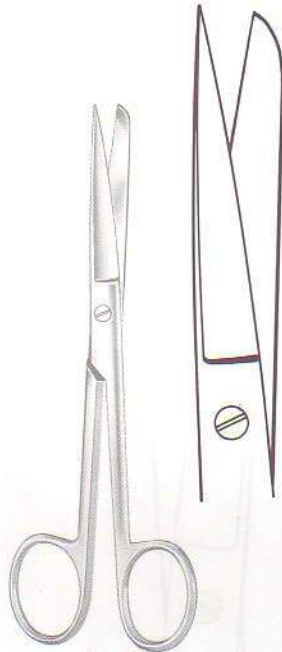

03.06.14
 14,5 cm - 5³/₄"

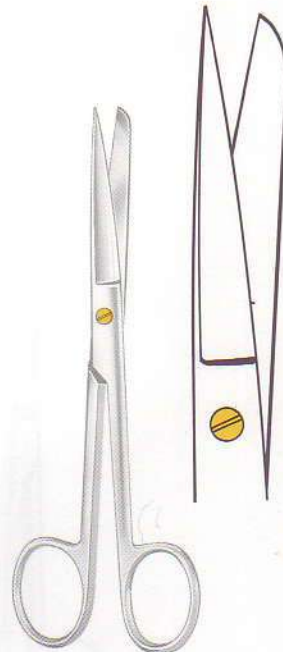

203.06.14
 14,5 cm - 5³/₄"
supercut

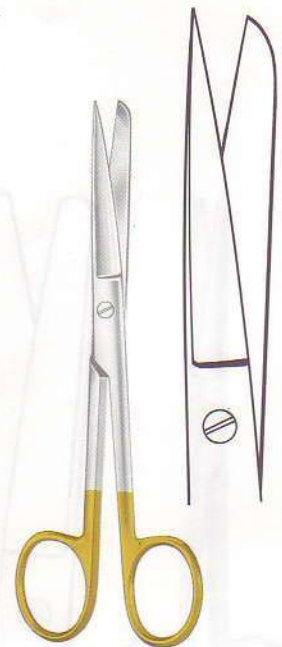

03.06.64
 14,5 cm - 5³/₄"
"HM"

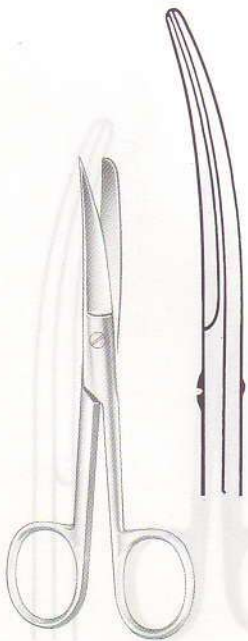

03.07.13
 13 cm - 5¹/₈"

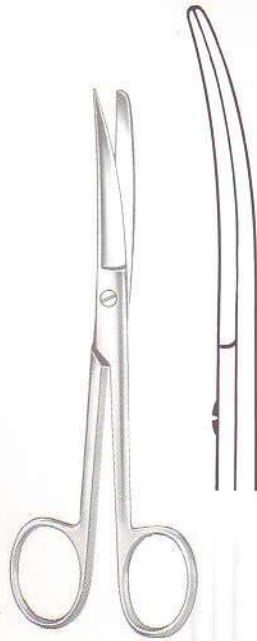

03.07.14
 14,5 cm - 5³/₄"

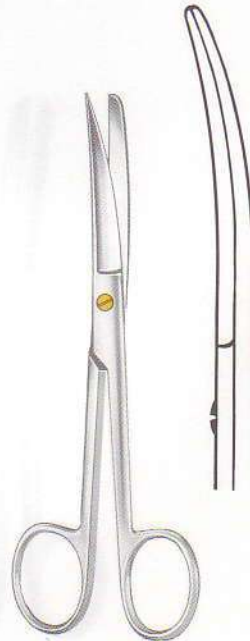

203.07.14
 14,5 cm - 5³/₄"
supercut

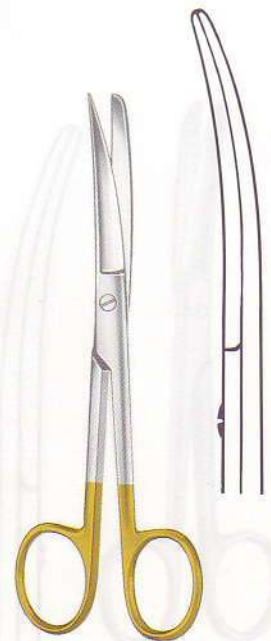

03.07.64
 14,5 cm - 5³/₄"
"HM"

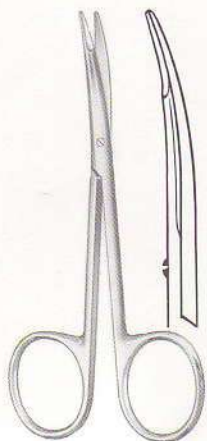

04.13.12
12 cm - 4³/₄"
Greenberg PAR (Shea)



204.13.62
12 cm - 4³/₄"
**Greenberg PAR (Shea)
supercut plus**



04.13.20
20 cm - 8"



04.13.13 13 cm - 5¹/₈"
04.13.15 15 cm - 6"



04.13.13



04.13.15

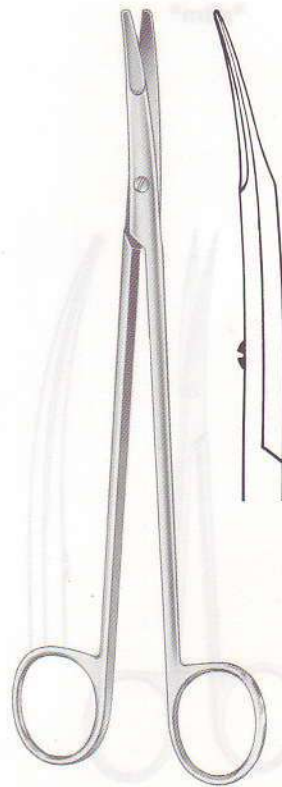

04.13.20
20 cm - 8"
Ragnell (Kilner)

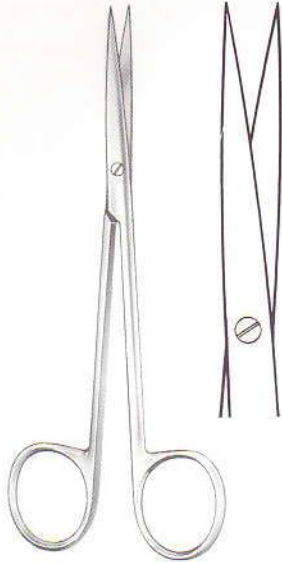

04.24.14
 14 cm - 5 1/2"
 "slim"



04.24.64
 14 cm - 5 1/2"
 slim "HM"

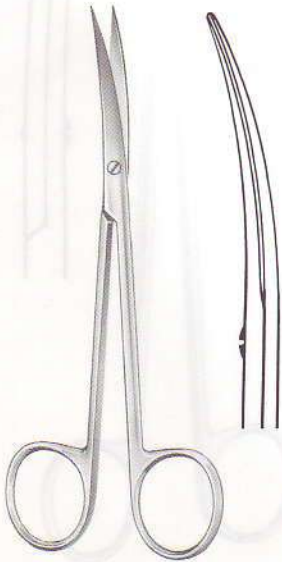

04.25.14
 14 cm - 5 1/2"
 "slim"



04.25.64
 14 cm - 5 1/2"
 slim "HM"

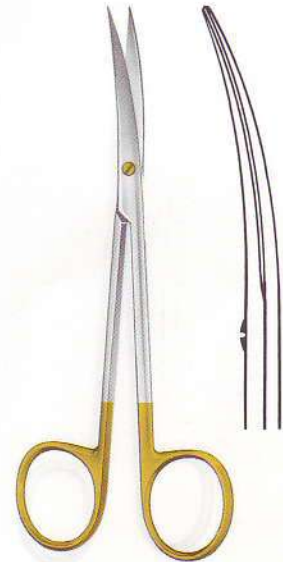

204.25.64
 14 cm - 5 1/2"
 slim supercut plus

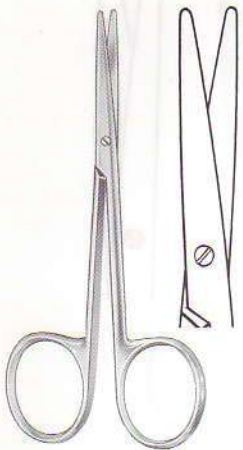

04.32.11
11,5 cm – 4 1/2"
Baby-Metzenbaum



204.32.11
11,5 cm – 4 1/2"
**Baby-Metzenbaum
supercut**

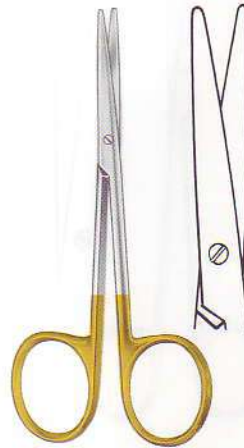

04.32.61
11,5 cm – 4 1/2"
**Baby-Metzenbaum
"HM"**

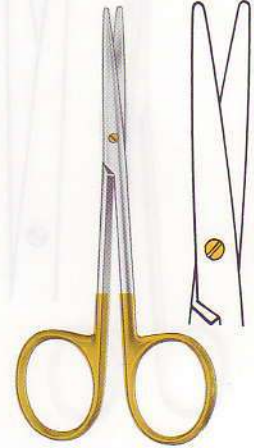

204.32.61
11,5 cm – 4 1/2"
**Baby-Metzenbaum
supercut plus**

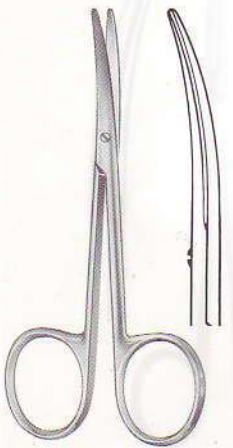

04.33.11
11,5 cm – 4 1/2"
Baby-Metzenbaum



204.33.11
11,5 cm – 4 1/2"
**Baby-Metzenbaum
supercut**



04.33.61
11,5 cm – 4 1/2"
**Baby-Metzenbaum
"HM"**

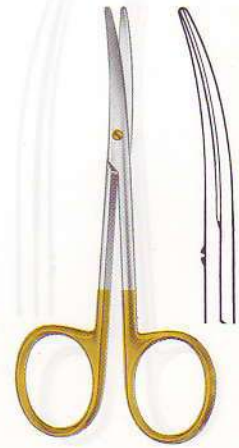

204.33.61
11,5 cm – 4 1/2"
**Baby-Metzenbaum
supercut plus**

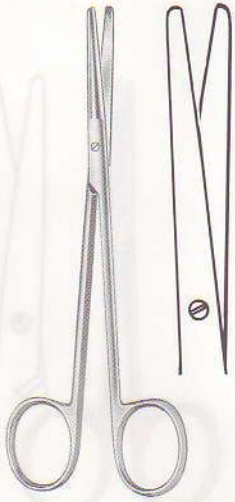

04.32.14
14 cm - 5 1/2"
Metzenbaum

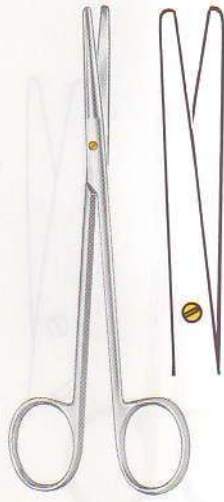

204.32.14
14 cm - 5 1/2"
**Metzenbaum
supercut**



04.32.64
14 cm - 5 1/2"
**Metzenbaum
"HM"**



204.32.64
14 cm - 5 1/2"
**Metzenbaum
supercut plus**



04.33.14
14 cm - 5 1/2"
Metzenbaum

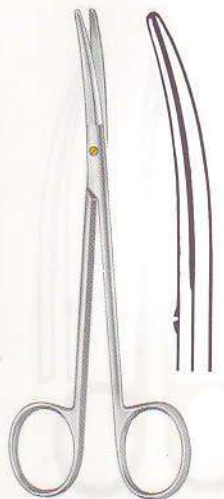

204.33.14
14 cm - 5 1/2"
**Metzenbaum
supercut**



04.33.64
14 cm - 5 1/2"
**Metzenbaum
"HM"**



204.33.64
14 cm - 5 1/2"
**Metzenbaum "HM"
supercut plus**

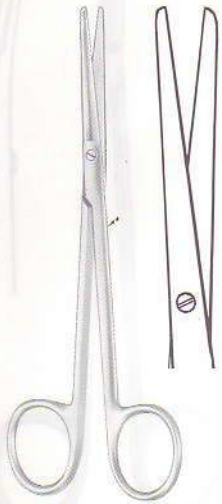

04.34.14
14 cm – 5½"
Metzenbaum-slim

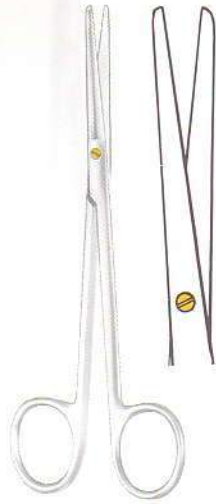

204.34.14
14 cm – 5½"
**Metzenbaum-slim
supercut**



04.34.64
14 cm – 5½"
**Metzenbaum-slim
"HM"**

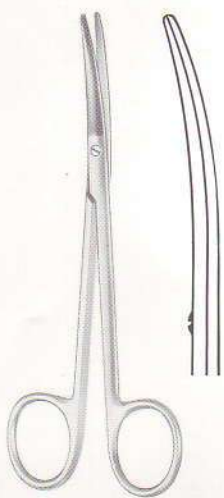

04.35.14
14 cm – 5½"
Metzenbaum-slim



204.35.14
14 cm – 5½"
**Metzenbaum-slim
supercut**



04.35.64
14 cm – 5½"
**Metzenbaum-slim
"HM"**



204.35.64
14 cm – 5½"
**Metzenbaum-slim
supercut plus**

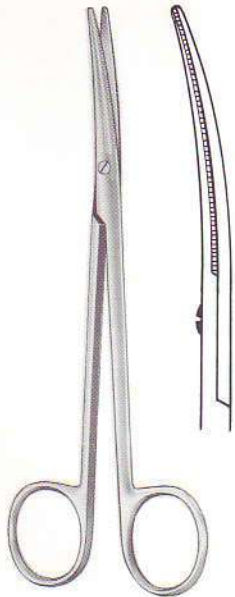

04.33.15
 15 cm - 6"
Metzenbaum



204.33.15
 15 cm - 6"
Metzenbaum supercut

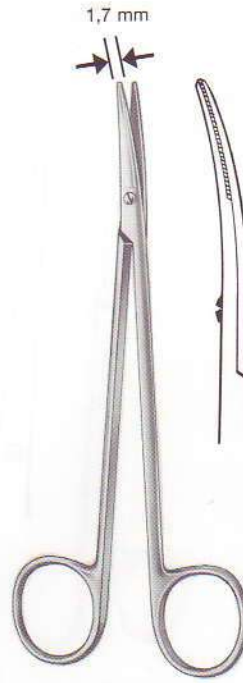

04.63.15
 15 cm - 6"

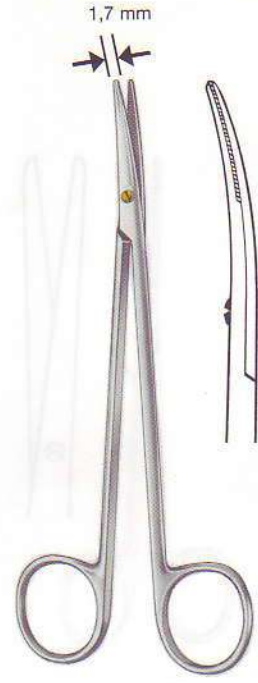

204.63.15
 15 cm - 6"
supercut

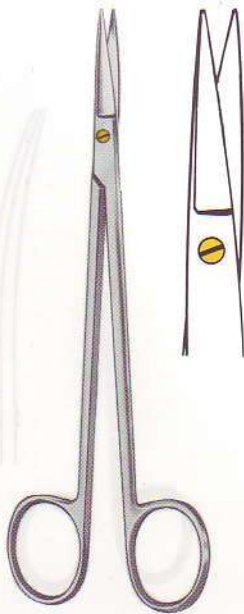

204.56.16
 16 cm - 6 1/4"
Brüser-Kelly supercut



204.57.16
 16 cm - 6 1/4"
Brüser-Kelly supercut

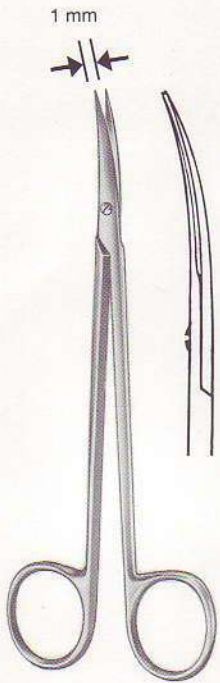

04.65.15
15 cm - 6"

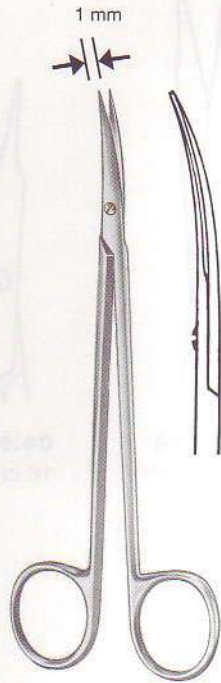

204.65.15
15 cm - 6"
supercut

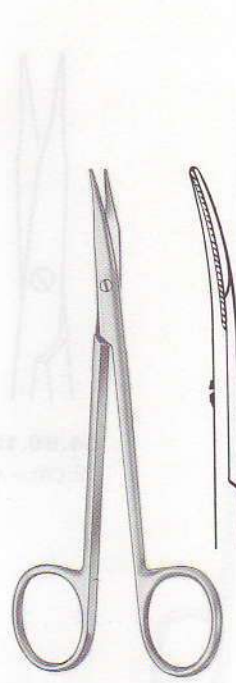

04.67.13
13 cm - 5 1/8"
Stevens

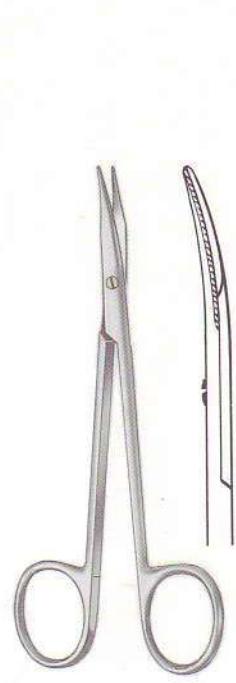

204.67.13
13 cm - 5 1/8"
Stevens supercut

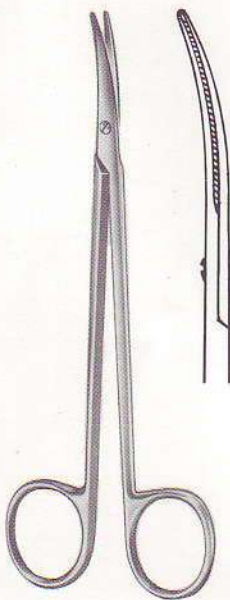

04.67.15
15 cm - 6"

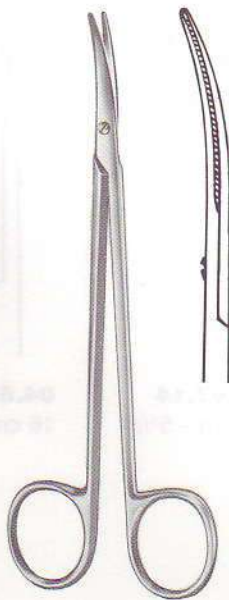

204.67.15
15 cm - 6"
supercut



Reynolds (Jameson)



04.66.12
12 cm - 4³/₄"



04.66.14
14 cm - 5¹/₂"



04.66.16
16 cm - 6¹/₄"



Reynolds (Jameson)



04.67.12
12 cm - 4³/₄"

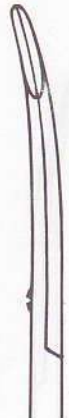

04.67.14
14 cm - 5¹/₂"



04.67.16
16 cm - 6¹/₄"

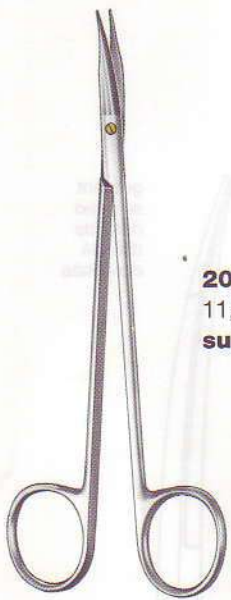

204.67.12
11,5 cm - 4 1/2"
supercut



204.67.16
16 cm - 6 1/4"
supercut

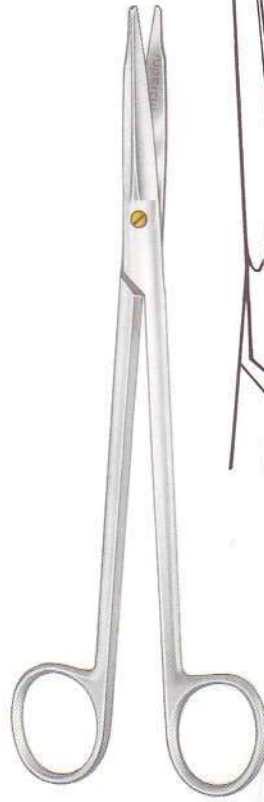

204.68.16 16,5 cm - 6 1/2"
204.68.20 20,5 cm - 8"
Fanous supercut

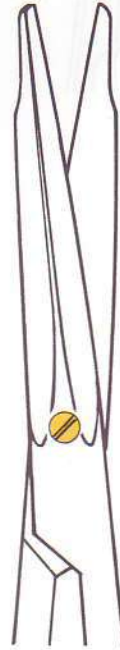

204.69.16 16,5 cm - 6 1/2"
204.69.20 20,5 cm - 8"
Fanous supercut



02.82.77
"8 - mo 05
nitram

02.82.77
"8 - mo 05
nitram

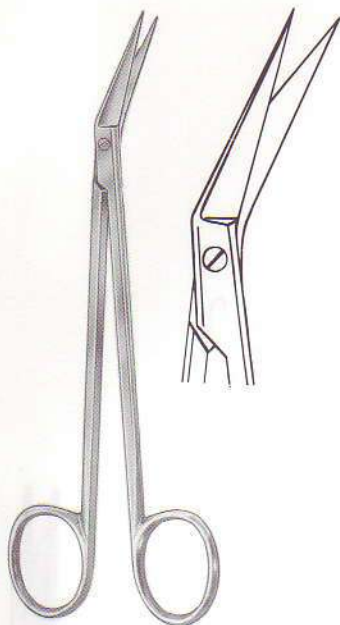

Gewebescherer
 Tissue Scissors
 Tijera para tejidos
 Ciseaux à tissus
 Forbici per Tendini

04.83.16
 16 cm - 6 1/4"
Locklin

Knorpelscheren
 Cartilage Scissors
 Tijeras para cartilagos
 Ciseaux à cartilages
 Forbici per cartilagine

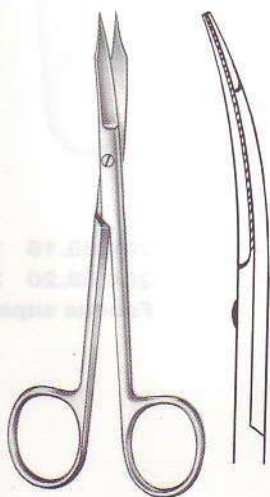

77.55.13
 13 cm - 5 1/8"
Martin

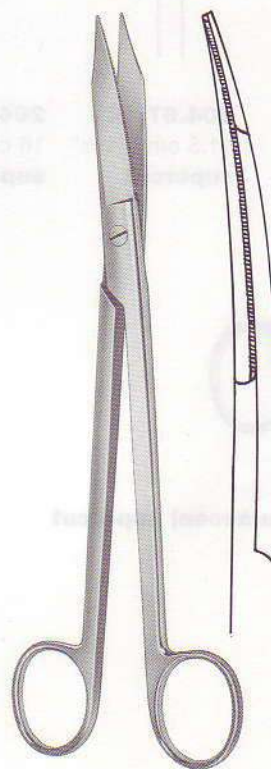

gezahnt
 serrated
 dentada
 dentelè
 dentellate

77.55.20
 20 cm - 8"
Martin

micro 2000

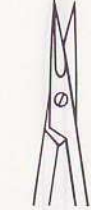

05.12.20



05.12.21

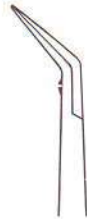

05.12.25

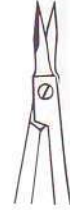

05.12.30



05.12.31

Vannas Schneiden
Vannas-type cutting edges
hojas según Vannas
lames selon Vannas
lame secondo Vannas

12,5 cm - 5"
micro 2000



05.15.20



05.15.21



05.18.20



05.18.21

15 cm - 6"
micro 2000

18 cm - 7"
micro 2000

micro 2000



05.15.70

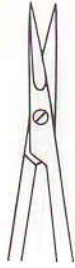

05.15.71



05.15.72



05.15.73



05.15.81



05.15.83



gezahnte Schneiden
 serrated cutting edges
 hojas dentadas
 lames dentées
 lame dentellate

runde Schneidblätter
 round cutting blades
 hojas redondas
 lames rondes
 lame rotonde

15 cm - 6"
micro 2000



05.18.70



05.18.71



Leichtmetall-Instrumente mit blau eloxierten Rundgriffen

- geringes Gewicht
- gut ausbalanciert
- sehr handlich
- ermüdungsfreies Arbeiten
- leicht zu pflegen
- korrosionsbeständig

Light-weight instruments with blue-colored anodized round handles

- extremely light weight
- well balanced
- easy to handle
- fatigueless working
- easy to care for
- corrosion-resistant

Instrumentos de metal ligero con mangos redondos azulados por anodización

- peso muy reducido
- bien equilibrados
- de fácil manejo
- operar sin fatigarse
- fáciles de cuidar
- anticorrosivos

Instruments en métal léger, avec manches ronds anodisés en bleu

- poids réduit
- bien équilibrés
- aisément maniables
- travail sans fatigue
- entretien faciles
- résistant à la corrosion

Strumenti di metallo leggero con manici rotondi, anodizzati azzurri

- minimo peso
- perfetta equilibratura
- maneggevoli
- non affaticano la mano
- manutenzione minima
- resistenti alla corrosione

18 cm - 7¹/₈"
micro 2000



15 cm - 6"

Rundgriff 8 mm Ø
Round Handle 8 mm Ø
Mango redondo 8 mm Ø
Manche rond 8 mm Ø
Manico rotondo Ø mm 8

9 mm



05.15.74



05.15.75

7 mm



05.15.76



05.15.77

Vannas Schneiden
Vannas-type cutting edges
hojas segun Vannas
lame selon Vannas
lame secondo Vannas



59.16.20
16 cm - 6 1/4"
Yasargil



59.16.21
16 cm - 6 1/4"
Yasargil



7,5 cm - 3"
Vannas



60.70.05



60.70.25

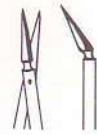

60.70.35



60.70.45



10 cm - 4"
Micro



60.73.30



60.73.31



60.73.57
 # 2, 11 cm - 4³/₈"
Wecker

stumpf
 blunt
 romo
 mousse
 smussa

spitz
 sharp
 agudo
 pointu
 acuta



8 cm - 3¹/₈"
**Mc Pherson-
 Vannas**



60.74.01

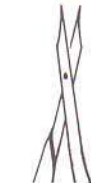

60.74.03

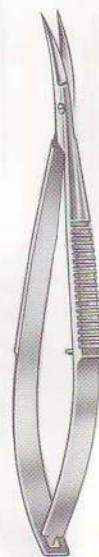

60.75.31
 11 cm - 4³/₈"
Castroviejo





29.12.80
 18 cm - 8"
 "MH" nosbA



30



29.02.80
 18 cm - 8"
 nosbA



29.12.80
 18 cm - 8"
 "MH" nosbA



29.12.80
 18 cm - 8"
 nosbA



29.12.80
 18 cm - 8"
 nosbA



29.12.80
 18 cm - 8"
 nosbA

Pinzetten
Forceps
Pinzas
Pinces
Pinze

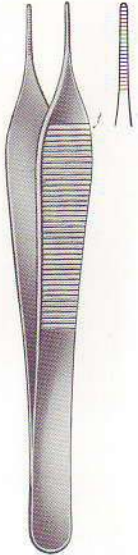

06.20.12
 12 cm - 4³/₄"
Adson



06.20.62
 12 cm - 4³/₄"
Adson "HM"



06.20.65
 15 cm - 6"
Adson "HM"



06.21.12
 12 cm - 4³/₄"
Adson



06.21.15
 15 cm - 6"
Adson



06.21.13
 12 cm - 4³/₄"
Adson



06.21.62
 12 cm - 4³/₄"
Adson "HM"



06.22.12
12 cm - 4³/₄"
Micro-Adson



06.22.15
15 cm - 6"
Micro-Adson



06.23.12
12 cm - 4³/₄"
Micro-Adson



06.23.15
15 cm - 6"
Micro-Adson



06.25.12
12 cm - 4³/₄"
Adson-Brown



06.25.72
12 cm - 4³/₄"
Adson-Brown



06.25.82
12 cm - 4³/₄"
Adson-Graefe



06.30.10



06.30.20



06.30.30

10 cm - 4"
Iris



06.31.10



06.31.20



06.31.30

10 cm - 4"
Iris



06.30.12
 12,5 cm - 5"



06.30.15
 15 cm - 6"



06.30.22
 12,5 cm - 5"



06.30.25
 15 cm - 6"



Semken



06.31.12
 12,5 cm - 5"



06.31.15
 15 cm - 6"



06.31.22
 12,5 cm - 5"



06.31.25
 15 cm - 6"



Semken

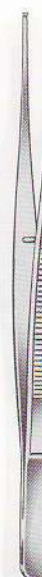

06.31.32
 12,5 cm - 5"
Semken





06.34.51
11 cm - 4³/₈"

"Select"



06.34.53
13 cm - 5¹/₈"



06.34.55
15 cm - 6"
"Select"



06.40.15
15 cm - 6"
McIndoe



06.35.51
11 cm - 4³/₈"

"Select"



06.35.53
13 cm - 5¹/₈"



06.35.55
15 cm - 6"
"Select"

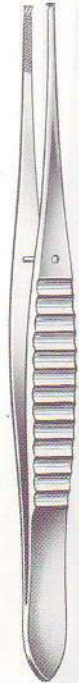

06.40.85
15 cm - 6"
Gillies



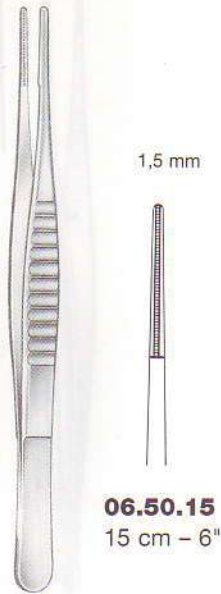

06.50.15
15 cm - 6"

DeBakey "AT"

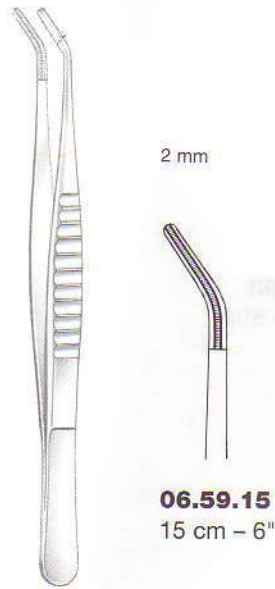

06.59.15
15 cm - 6"

DeBakey "AT"



"AT" = atraumatic Riefung
 atraumatic serrations
 con estriado atraumático
 avec striure atraumatique
 striatura atraumatica

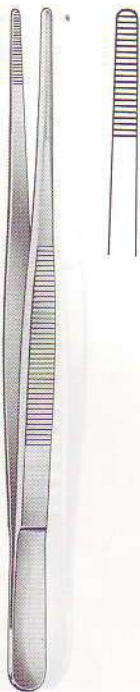

06.00.15
15 cm - 6"
Standard



06.02.65
15 cm - 6"
Potts Smith "HM"



06.07.14
14,5 cm - 5³/₄"



06.60.68
18 cm - 7¹/₈"
Cushing "HM"



06.60.69
18 cm - 7¹/₈"
Cushing "HM"

mit Dissektorende
with dissector end
extremo sirviendo de legra
extrémité dissecteur
parte finale utilizzabile come dissettore

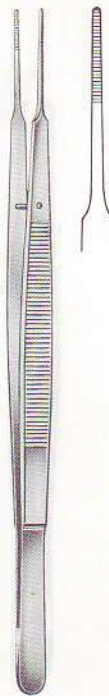

06.60.90
18 cm - 7¹/₈"
Gerald



06.60.91
18 cm - 7¹/₈"
Gerald



06.83.15
15 cm - 6"
Adlerkreutz

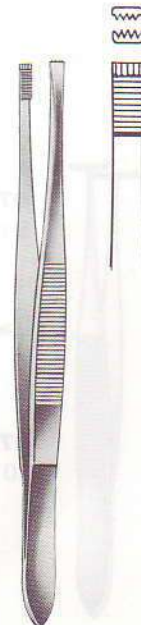

06.83.85
15 cm - 6"
Adlerkreutz

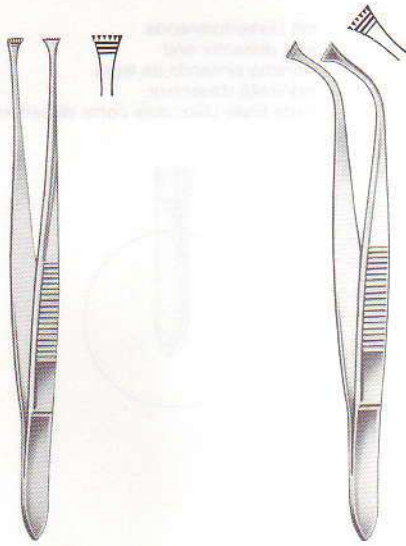

07.00.10
 11 cm - 4³/₈"
Green

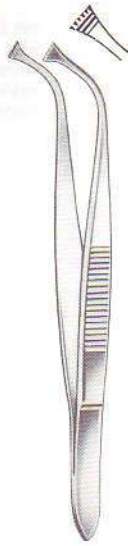

07.00.30
 11 cm - 4³/₈"
Fox

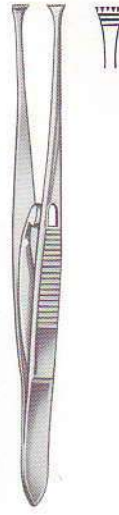

07.01.10
 11 cm - 4³/₈"
Hinderer

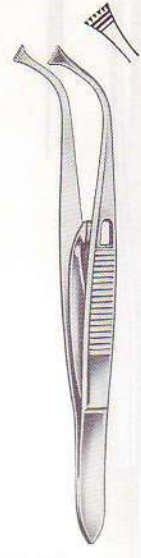

07.01.30
 11 cm - 4³/₈"
Hinderer

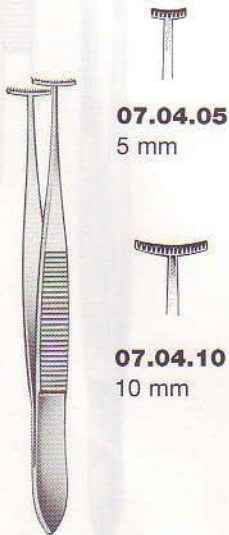

07.04.05
 5 mm

07.04.10
 10 mm

10 cm - 4"
Green

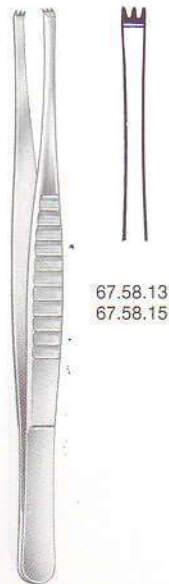

67.58.13
 67.58.15

67.58.13 13 cm - 5¹/₈"
67.58.15 15 cm - 6"
Fox

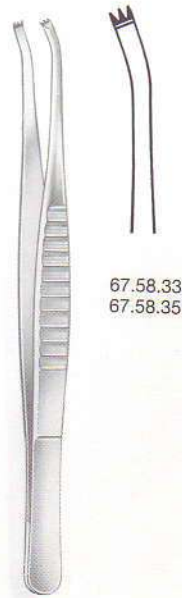

67.58.33
 67.58.35

67.58.33 13 cm - 5¹/₈"
67.58.35 15 cm - 6"
Fox



67.58.43
 13 cm - 5¹/₈"
Hinderer

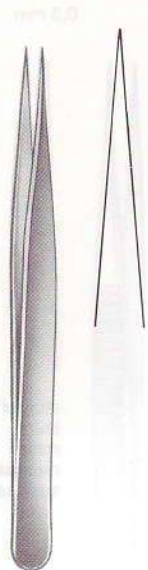

07.60.03
no. 3
11,5 cm – 4½"



07.60.04
no. 4
11 cm – 4¾"



07.60.05
no. 5
11 cm – 4¾"



07.60.07
no. 7
11,5 cm – 4½"

micro 2000



07.61.05
10,5 cm – 4⅛"
micro 2000



07.61.06
10,5 cm – 4⅛"
micro 2000

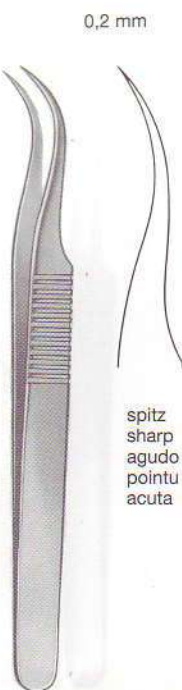

07.61.07
11,5 cm – 4½"
micro 2000

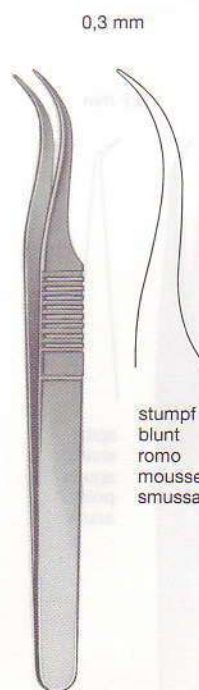

07.61.08
11,5 cm – 4½"
micro 2000

micro 2000

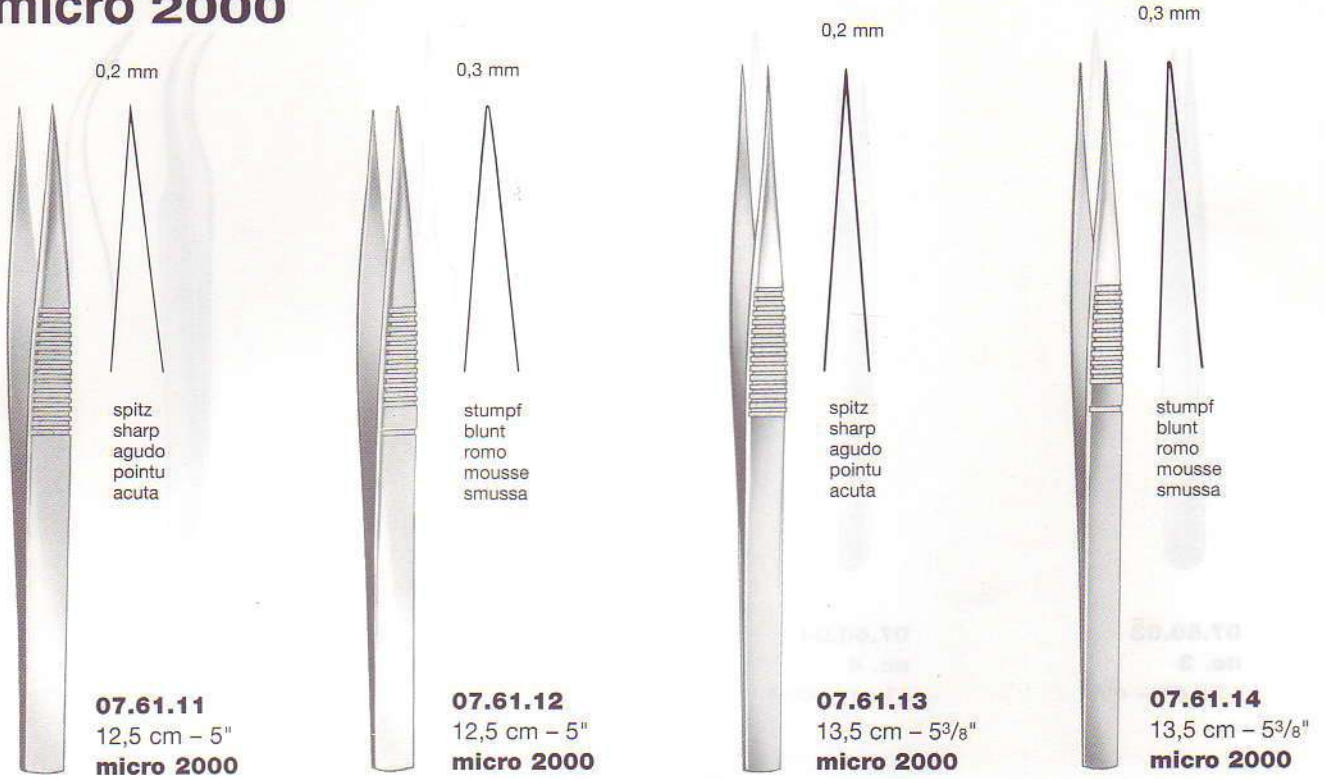

micro 2000

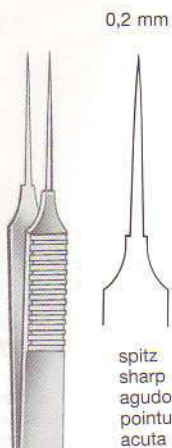

07.63.01
10,5 cm – 4¹/₈"
micro 2000

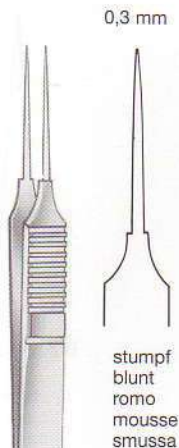

07.63.02
10,5 cm – 4¹/₈"
micro 2000

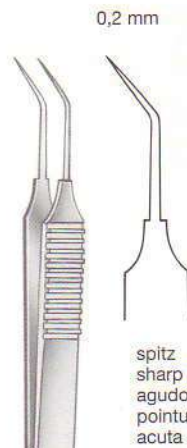

07.63.25
10,5 cm – 4¹/₈"
micro 2000

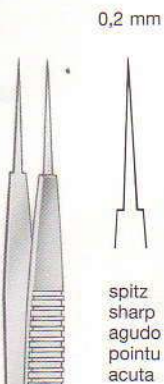

07.63.31
14 cm – 5¹/₂"
micro 2000



07.63.32
14 cm – 5¹/₂"
micro 2000

micro 2000



12 cm - 4³/₄"
micro 2000

0,2 mm



07.64.03

spitz
 sharp
 agudo
 pointu
 acuta

0,3 mm



07.64.04

stumpf
 blunt
 romo
 mousse
 smussa

0,2 mm



07.64.13

spitz
 sharp
 agudo
 pointu
 acuta

0,3 mm



07.64.14

stumpf
 blunt
 romo
 mousse
 smussa



15 cm - 6"
micro 2000

0,2 mm



07.64.63

spitz
 sharp
 agudo
 pointu
 acuta

0,3 mm



07.64.64

stumpf
 blunt
 romo
 mousse
 smussa

0,2 mm



07.64.73

spitz
 sharp
 agudo
 pointu
 acuta

0,3 mm



07.64.74

stumpf
 blunt
 romo
 mousse
 smussa

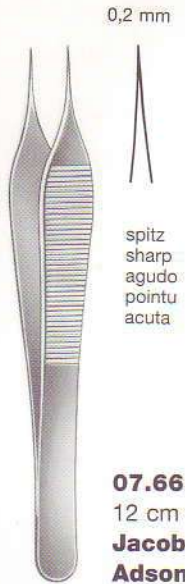

07.66.12
12 cm - 4³/₄"
Jacobson-Adson

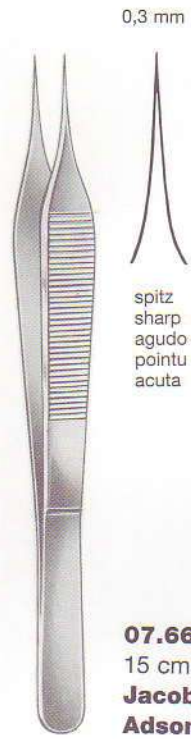

07.66.15
15 cm - 6"
Jacobson-Adson

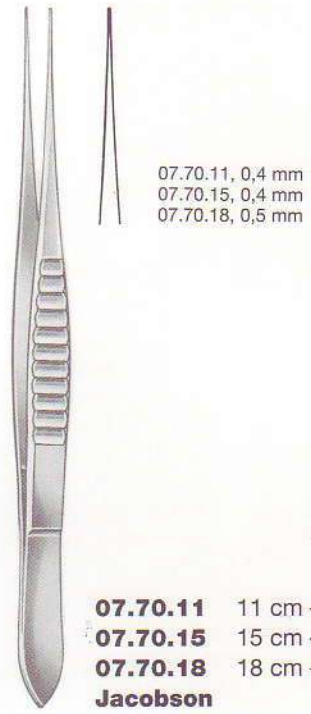

07.70.11 11 cm - 4³/₈"
07.70.15 15 cm - 6"
07.70.18 18 cm - 7¹/₈"
Jacobson

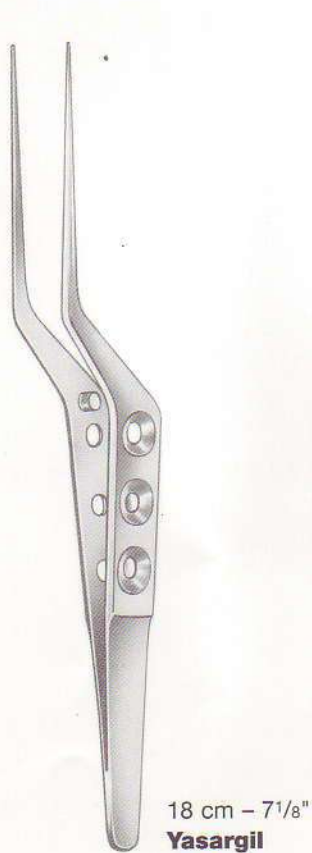

07.06.10
07.06.10
07.06.10



15 cm - 15
15 cm - 15
15 cm - 15
15 cm - 15
15 cm - 15

07.06.10

07.06.10
07.06.10
07.06.10

07.06.10
07.06.10
07.06.10
07.06.10
07.06.10



15 cm - 15
15 cm - 15



13 cm - SW
14 cm - SW
15 cm - B
16 cm - SW
17 cm - B
18 cm - B

00.10.00
10 cm - B

00.10.13 13 cm - SW
00.10.14 14 cm - SW

00.10.15 15 cm - SW
00.10.16 16 cm - SW

Sonden
Probes
Estiletes
Stylets
Sonde

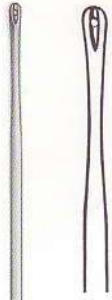

09.07.20
20 cm - 8"



09.08.24
24 cm - 9½"



aus Silber
Sterling silver
de plata pura
en argent pur
in argento puro

- 09.12.13** 13 cm - 5⅛"
- 09.12.14** 14,5 cm - 5¾"
- 09.12.15** 15 cm - 6"
- 09.12.18** 18 cm - 7⅛"
- 09.12.20** 20 cm - 8"
- USA-Modell**



09.15.13 13 cm - 5⅛"
09.15.14 14,5 cm - 5¾"



09.16.13 13 cm - 5⅛"
09.16.14 14,5 cm - 5¾"



aus Silber
Sterling silver
de plata pura
en argent pur
in argento puro



aus Silber
Sterling silver
de plata pura
en argent pur
in argento puro

60.34.10 0000-000
60.34.11 00-0
60.34.12 1-2
60.34.14 3-4
60.34.16 5-6
60.34.18 7-8
Bowman
13 cm - 5 1/8"

60.34.31 00-0
60.34.32 1-2
60.34.34 3-4
60.34.36 5-6
60.34.38 7-8
Bowman (Williams)
13 cm - 5 1/8"

Größenskala für Sonden
Size Scale for Probes
Escala de tamaños para estiletos exploradores
Echelle comparative pour sondes
Scala comparativa per sonde

fig.	0000	000	00	0	1	2	3	4	5	6	7	8
Ø mm	0.5	0.6	0.7	0.8	0.9	1.1	1.3	1.4	1.5	1.6	1.8	1.9

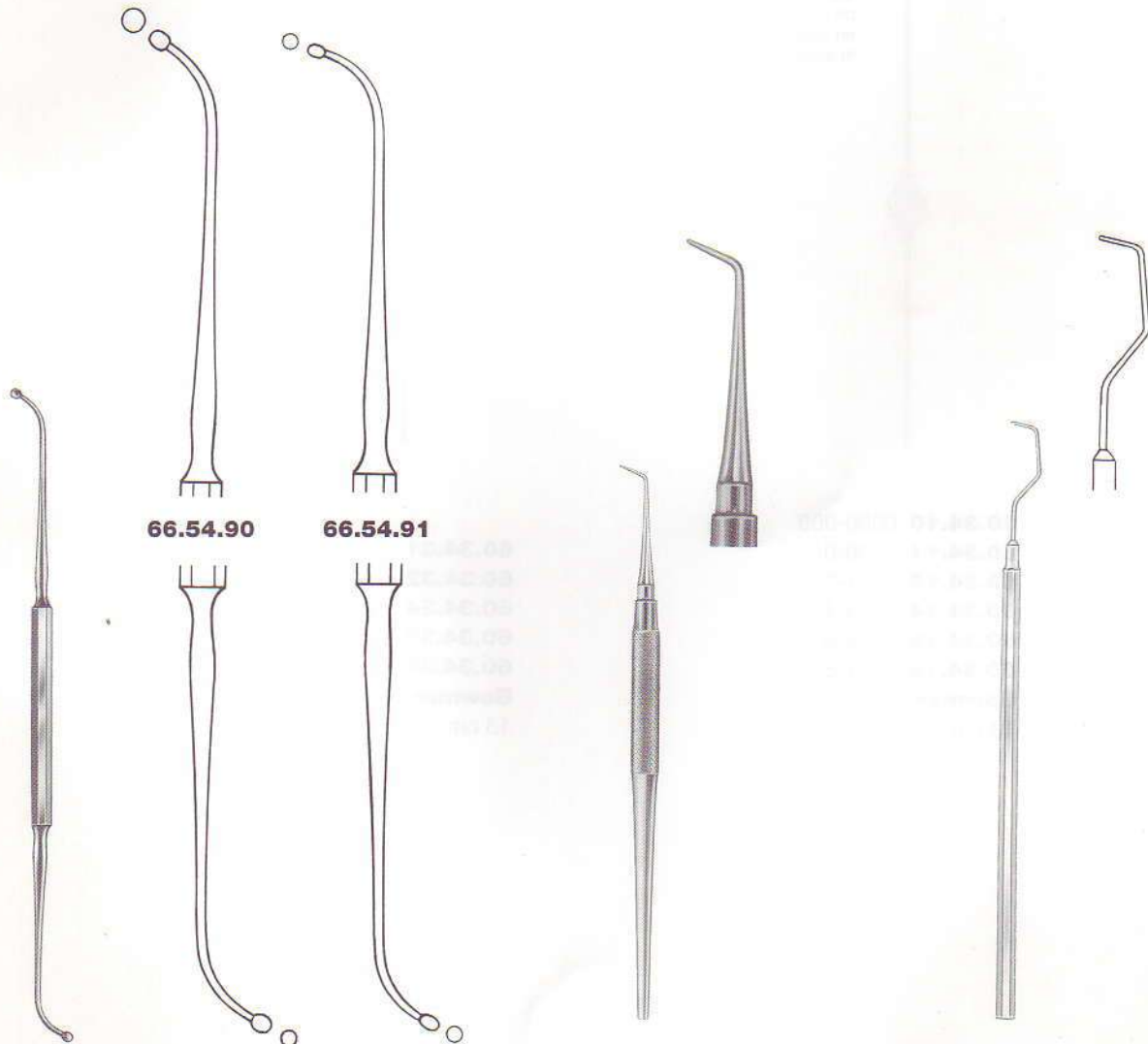

66.54.90

66.54.91

78.29.14
14 cm - 5 1/2"
Bunnell

78.29.15
15 cm
Mod. Lanz

17 cm - 6 3/4"
Kistner





00.25.00
34 cm - 32"
Aspirator
Suction

00.27.00
30 cm - 28"
Aspirator
Suction



00.28.00
30 cm - 28"
Aspirator
Suction



00.29.00
30 cm - 28"
Aspirator
Suction

**Sauginstrumente
Aspirating Instruments
Instrumentos de aspiración
Instruments à aspiration
Strumenti per aspirazione**

mm 08
mm 08 x 0
mm 08 x 0

Nutzlänge 15 cm
 Working length 15 cm - 6"
 Largo útil 15 cm
 Longueur utile 15 cm
 Lungh. utile cm. 15



09.81.42 2 mm
09.81.43 3 mm
 15 cm - 6"
Walter

Nutzlänge 12,5 cm
 Working length 12,5 cm - 5"
 Largo útil 12,5 cm
 Longueur utile 12,5 cm
 Lungh. utile cm. 12,5



Luer ♀

09.83.06 Charr. 6
09.83.08 Charr. 8
09.83.10 Charr. 10
Frazier

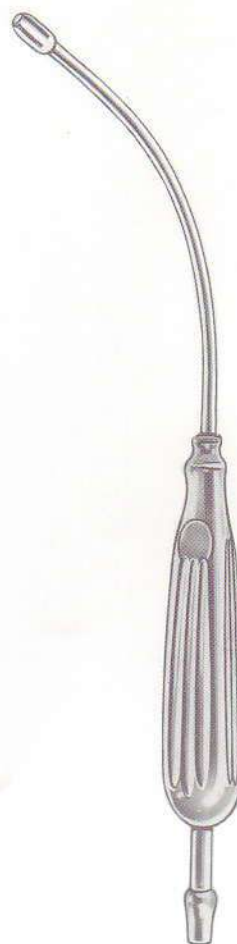

09.85.08
 24 cm - 9½"
Andrews-Pynchon



62.22.10 Ø 1,0 x 80 mm
62.22.15 Ø 1,5 x 80 mm
62.22.20 Ø 2,0 x 80 mm
Baron (Schuknecht)



11.00.01

11.00.02



Medicon-Needle
Holders

Medicon-Needle
Holders



11.00.01

11.00.02



Nahtinstrumente
Suture Instruments
Instrumentos para sutura
Instruments à sutures
Strumenti per sutura

Copyright-Medicon



10.00.11

10.00.12

11,5 cm - 4½"
Medicon-Halsted



10.00.62
 11,5 cm - 4½"
Medicon-Halsted "HM"



10.08.11
 12 cm - 4¾"

10.08.14
 14,5 cm - 5¾"

10.08.17
 17 cm - 6¾"

Obwegeser-Gillies



10.08.18
17 cm - 6 3/4"
Obwegeser-Gillies



10.08.07
15 cm - 6"
Webster "HM"

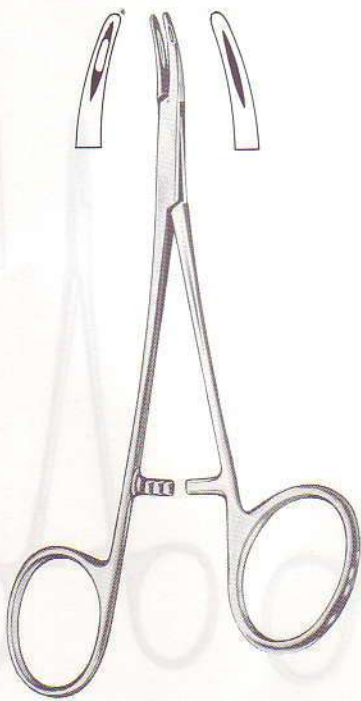

10.08.15
15 cm - 6"
Converse

10.08.13
15 cm - 6"
Webster "HM"



10.08.65
15 cm - 6"
Converse "HM"

10.08.07
15 cm - 6"
Webster "HM"



10.08.12
12,5 cm - 5"
Neivert



10.08.62
12,5 cm - 5"
Neivert "HM"



10.10.12
12,5 cm - 5"
Webster



10.10.62
12,5 cm - 5"
Webster "HM"



10.10.13
13,5 cm - 5³/₈"
Halsey



10.10.63
13,5 cm - 5³/₈"
Halsey "HM"



10.12.12
12,5 cm - 5"
Wright (Derf)



10.12.62
12,5 cm - 5"
Wright (Derf) "HM"



10.12.82
12,5 cm - 5"
Derf-Converse



10.15.13
13 cm - 5 1/8"
Brown



10.18.15
15 cm - 6"
Mayo-Hegar



10.18.65
15 cm - 6"
Mayo-Hegar "HM"



10.20.14 15 cm - 6"
Baby-Crile-Wood



10.20.64 15 cm - 6"
Baby-Crile-Wood "HM"



10.20.15 15 cm - 6"
Crile-Wood



10.20.65 15 cm - 6"
Crile-Wood "HM"



10.26.63 13 cm - 5 1/8"
10.26.65 15 cm - 6"
Ryder (French Eye) "HM"



10.26.63



10.26.65



10.28.63



10.28.65



10.28.64



10.28.66



10.28.63 13 cm - 5 1/8"
10.28.65 15 cm - 6"
Mini-Ryder "HM"

10.28.64 13 cm - 5 1/8"
10.28.66 15 cm - 6"



10.39.17
 17 cm - 6¾"
Senning



10.60.13
 12 cm - 4¾"
Olsen-Hegar-MINI



10.60.63
 12 cm - 4¾"
Olsen-Hegar-MINI "HM"



10.60.14
 14 cm - 5½"
Olsen-Hegar



10.60.64
 14 cm - 5½"
Olsen-Hegar "HM"

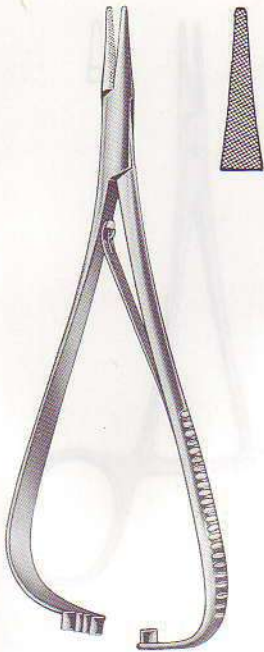

11.18.17
 17 cm - 6³/₄"
Mathieu-Kocher



11.18.67
 17 cm - 6³/₄"
Mathieu-Kocher "HM"

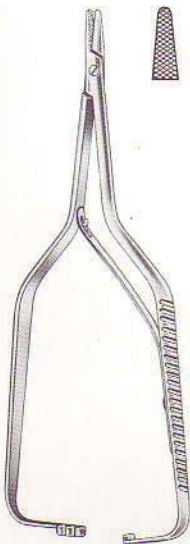

11.50.12
 12 cm - 4³/₄"
Boynton

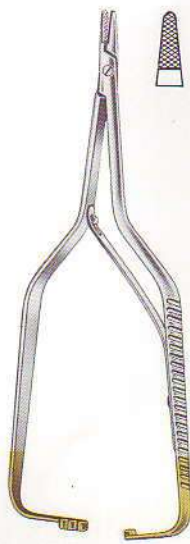

11.50.62
 12 cm - 4³/₄"
Boynton "HM"

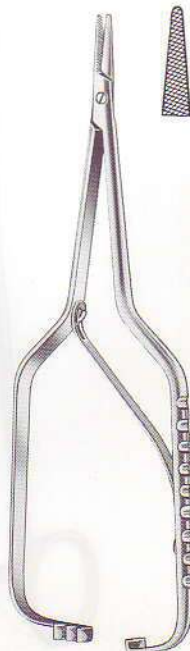

11.50.16
 16 cm - 6¹/₄"
Arruga

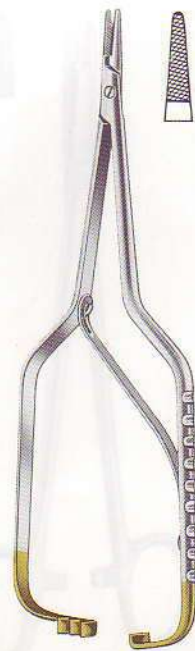

11.50.66
 16 cm - 6¹/₄"
Arruga "HM"



11.62.34
11.62.37

11.62.34 14 cm – 5½"
11.62.37 17 cm – 6¾"
Castroviejo



11.62.64
11.62.67

11.62.64 14 cm – 5½"
11.62.67 17 cm – 6¾"
Castroviejo "HM"



11.62.84
11.62.87

11.62.84 14 cm – 5½"
11.62.87 17 cm – 6¾"
Castroviejo "HM"



11.74.23
14 cm – 5½"
Barraquer



11.74.25
14 cm – 5½"
Barraquer



11.82.18
18,5 cm – 7¼"
Jacobson

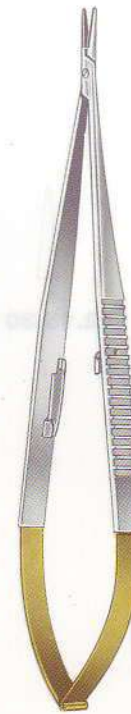

11.82.68
18,5 cm – 7¼"
Jacobson "HM"

micro 2000

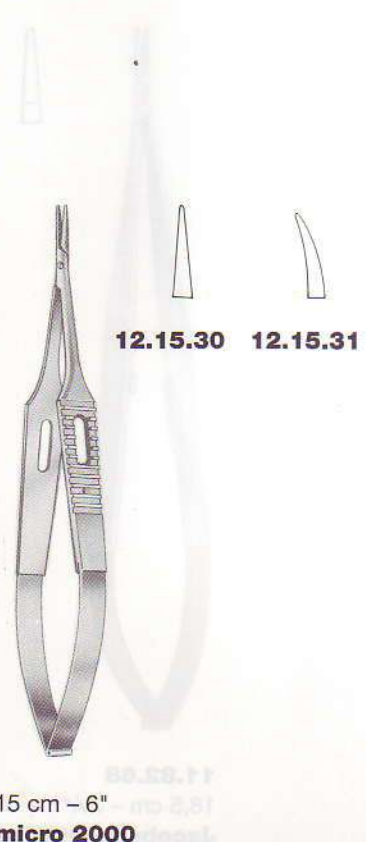
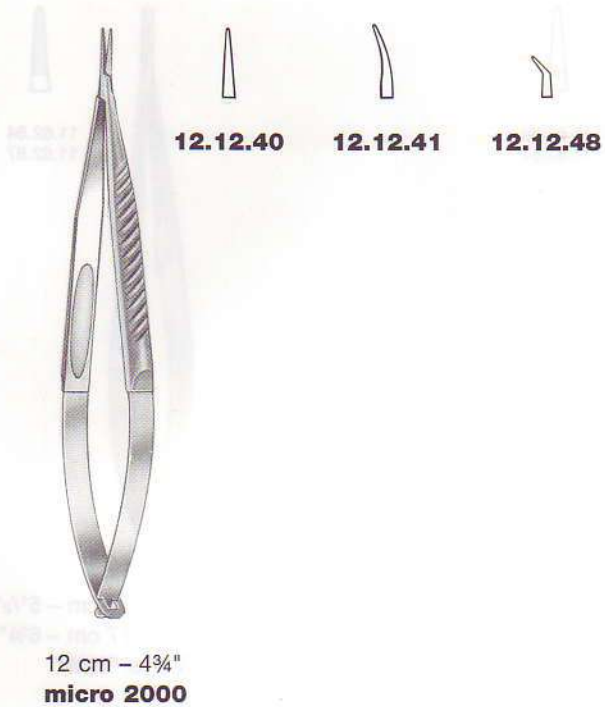

micro 2000



12.15.70

12.15.71



12.15.72

12.15.73

mit Sperre
 with catch
 con cremallera
 avec crémaillère
 con cremagliera

15 cm - 6"
micro 2000



15 cm - 6"
micro 2000

Leichtmetall-Instrumente mit
 blau eloxierten Rundgriffen

- geringes Gewicht
- gut ausbalanciert
- sehr handlich
- ermüdungsfreies Arbeiten
- leicht zu pflegen
- korrosionsbeständig

Light-weight instruments with
 blue-colored anodized round handles

- extremely light weight
- well balanced
- easy to handle
- fatigueless working
- easy to care for
- corrosion-resistant

Instrumentos de metal ligero con
 mangos redondos azulados por anodización

- peso muy reducido
- bien equilibrados
- de fácil manejo
- operar sin fatigarse
- fáciles de cuidar
- anticorrosivos



12.18.70

12.18.71



12.18.72

12.18.73

mit Sperre
 with catch
 con cremallera
 avec crémaillère
 con cremagliera

18 cm - 7¹/₈"
micro 2000



18 cm - 7¹/₈"
micro 2000

Instrument en métal léger,
 avec manches ronds anodisés en bleu

- poids réduit
- bien équilibrés
- aisément maniables
- travail sans fatigue
- entretien faciles
- résistant à la corrosion

Strumenti di metallo leggero
 con manici rotondi, anodizzati azzurri

- minimo peso
- perfetta equilibratura
- maneggevoli
- non affaticano la mano
- manutenzione minima
- resistenti alla corrosione



13 cm - 5 1/8"

(a) (a) (b)

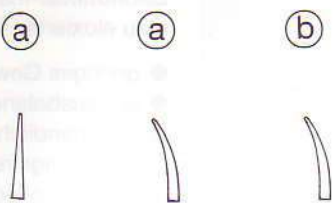

12.12.54	Spitze 0,4 mm Ø	Spitze 0,5 mm Ø
	Tips 0,4 mm Ø	Tips 0,5 mm Ø
	Punta 0,4 mm Ø	Punta 0,5 mm Ø
	Pointe 0,4 mm Ø	Pointe 0,5 mm Ø
	Punta mm, 0,4 Ø	Punta mm, 0,5 Ø



15 cm - 6"

(a) (a)

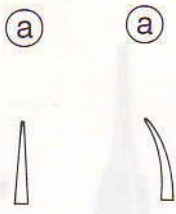

12.15.76	Spitze 0,4 mm Ø
	Tips 0,4 mm Ø
	Punta 0,4 mm Ø
	Pointe 0,4 mm Ø
	Punta mm, 0,4 Ø



18 cm - 7 1/8"

(a) (a)

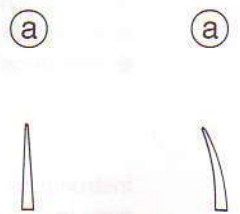

12.18.76	Spitze 0,4 mm Ø
	Tips 0,4 mm Ø
	Punta 0,4 mm Ø
	Pointe 0,4 mm Ø
	Punta mm, 0,4 Ø



(b) (b)

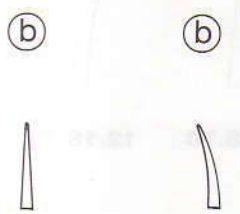

12.18.80	Spitze 0,5 mm Ø
	Tips 0,5 mm Ø
	Punta 0,5 mm Ø
	Pointe 0,5 mm Ø
	Punta mm, 0,5 Ø

(a) Rundgriff 8 mm Ø
 Round Handle 8 mm Ø
 Mango redondo 8 mm Ø
 Manche rond 8 mm Ø
 Manico rotondo Ø mm. 8

(b) Rundgriff 10 mm Ø
 Round Handle 10 mm Ø
 Mango redondo 10 mm Ø
 Manche rond 10 mm Ø
 Manico rotondo Ø mm. 10



13.11.10
 18 cm – 7¹/₈"
Henton



13.11.12
 19 cm – 7¹/₂"
Henton



13.11.13
 19 cm – 7¹/₂"
Henton



13.11.17
 20 cm – 8"



13.12.24
 20 cm – 8"
**Deschamps-
 Baby**



13.12.25
 20 cm – 8"
**Deschamps-
 Baby**

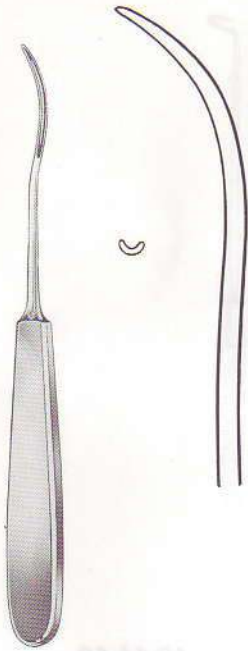

13.32.03
 2 mm, 19,5 cm – 7¾"
Koenig

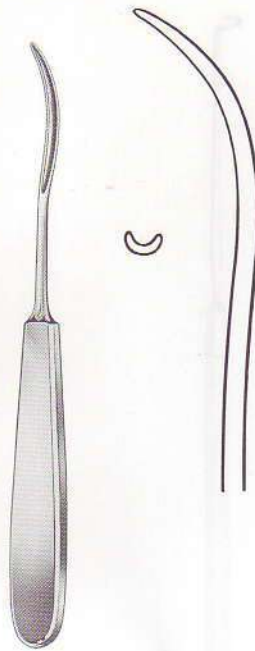

13.32.05
 5 mm, 19,5 cm – 7¾"
Koenig

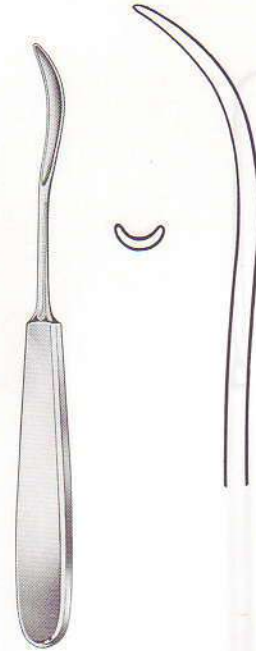

13.32.07
 7 mm, 19,5 cm – 7¾"
Koenig



13.13.02
 3 mm
 21 cm – 8¼"
Deschamps

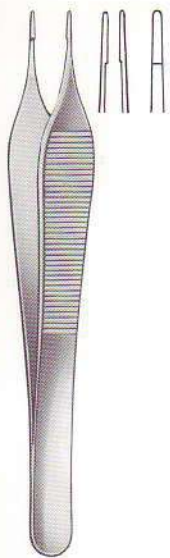

13.70.10 1 mm
13.70.20 2 mm
12 cm - 4¾"
Adson



13.70.11 1 mm
13.70.21 2 mm
12 cm - 4¾"
Adson

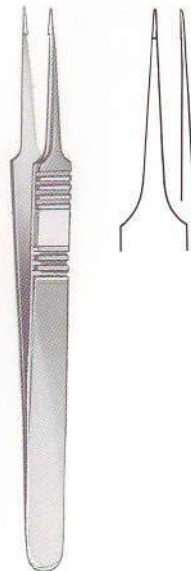

13.70.42
10,5 cm - 4 1/8"
micro 2000

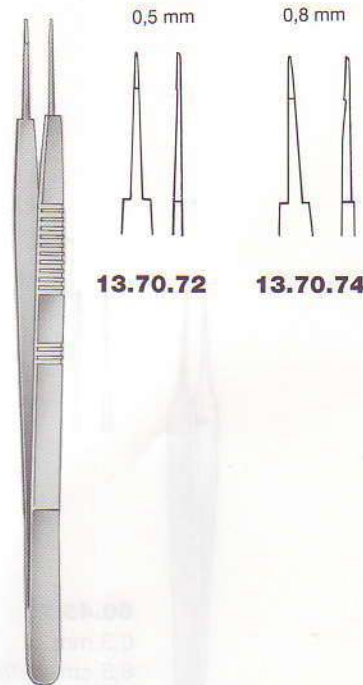

14 cm - 5½"
micro 2000

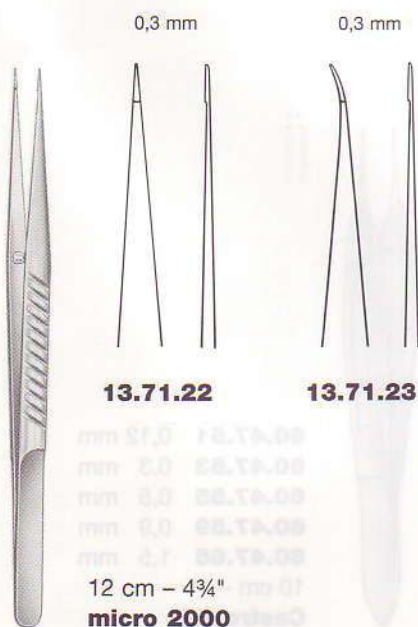

13.71.22
12 cm - 4¾"
micro 2000

13.71.23



13.71.42

13.71.43

15 cm - 6"
micro 2000



60.45.23
 0,3 mm
 8,5 cm – 3³/₈"
McPherson



60.45.28
 0,3 mm
 8,5 cm – 3³/₈"
McPherson

1 x 2 Zähne
 1 x 2 teeth
 1 x 2 dientes
 1 x 2 dents
 denti 1 x 2



60.47.01 0,12 mm
60.47.03 0,3 mm
60.47.05 0,5 mm
60.47.09 0,9 mm
60.47.15 1,5 mm
 10 cm – 4"
Castroviejo

1 x 2 Zähne
 1 x 2 teeth
 1 x 2 dientes
 1 x 2 dents
 denti 1 x 2

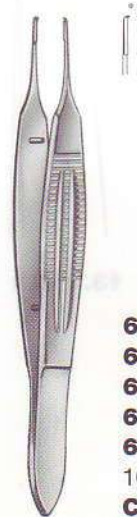

60.47.51 0,12 mm
60.47.53 0,3 mm
60.47.55 0,5 mm
60.47.59 0,9 mm
60.47.65 1,5 mm
 10 cm – 4"
Castroviejo

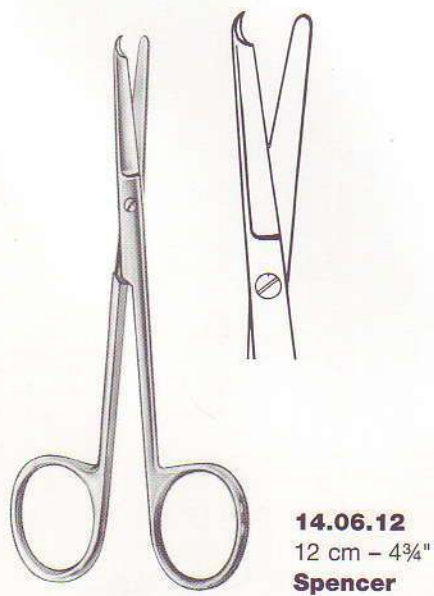



14.06.13
13 cm - 5/8"
Ligatures

14.06.13
13 cm - 5/8"
Suturing

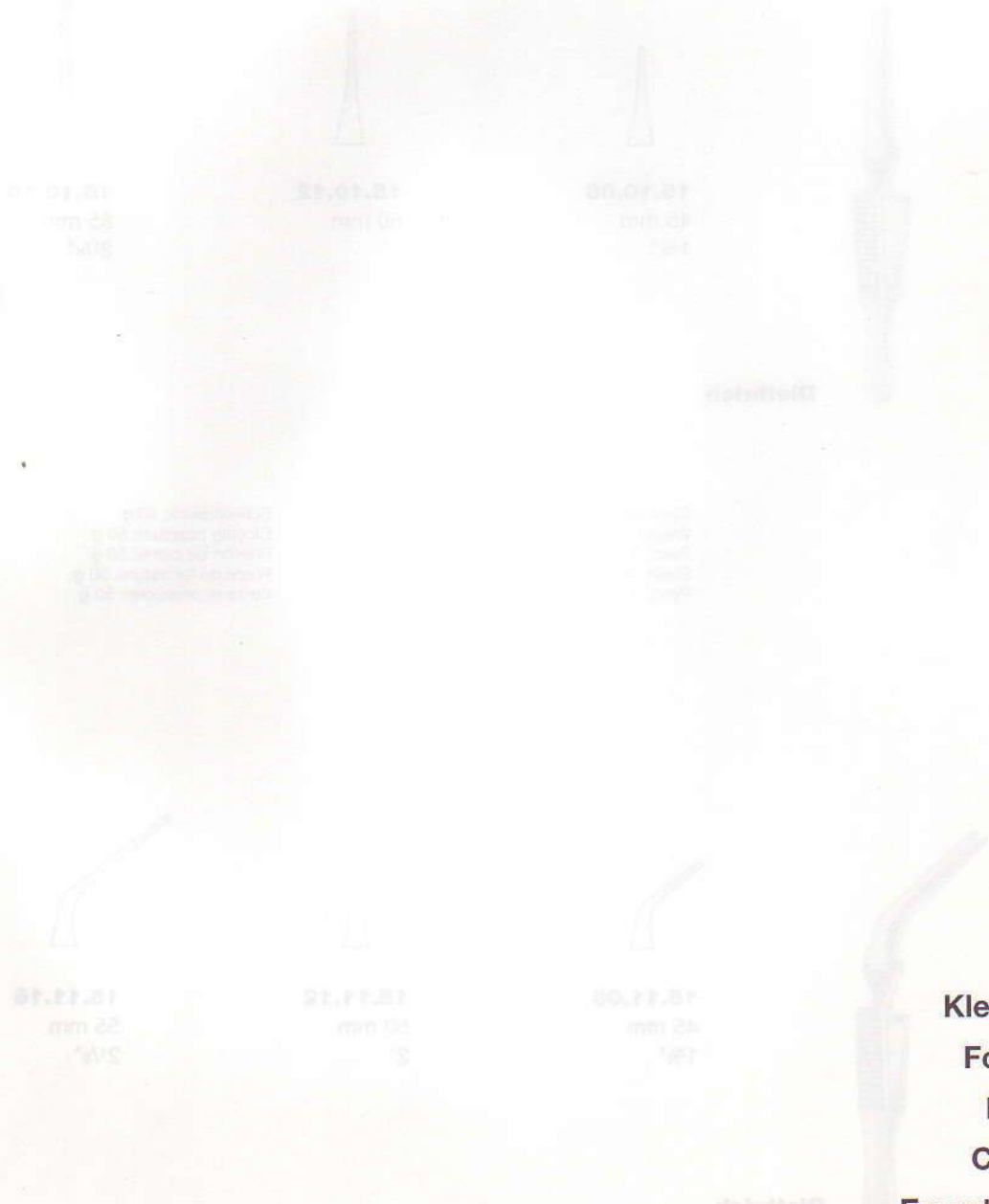

Klemmen
Forceps
Pinzas
Clamps
Emostatiche

Bulldog-Klemmen
 Bulldog Clamps
 Pinzas Bulldog
 Clamps Bulldog
 Pinze Bulldog



Diethrich



15.10.08
 45 mm
 1¾"



15.10.12
 50 mm
 2"



15.10.16
 55 mm
 2⅛"

Gewicht: 3 g
 Weight: 3 g
 Peso: 3 g
 Poids: 3 g
 Peso: 3 g

Schließdruck: 50 g
 Closing pressure: 50 g
 Presión de cierre: 50 g
 Force de fermeture: 50 g
 Forza di pressione: 50 g

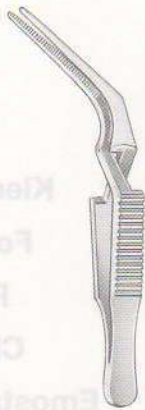

Diethrich



15.11.08
 45 mm
 1¾"



15.11.12
 50 mm
 2"



15.11.16
 55 mm
 2⅛"

Klemmen
 Forceps
 Pinzas
 Clamps
 Emostatiche

**Bulldog-Klemmen
Bulldog Clamps
Pinzas Bulldog
Clamps Bulldog
Pinze Bulldog**

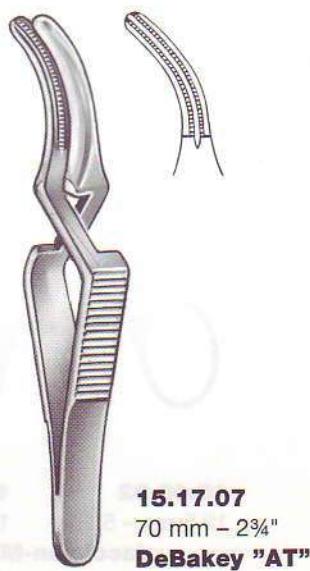
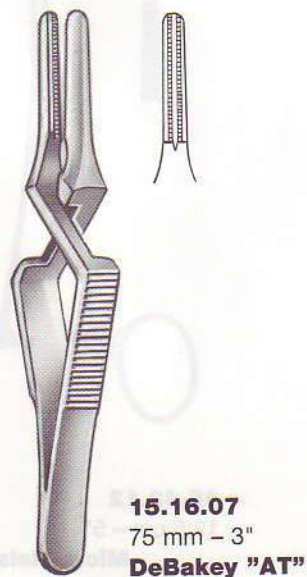
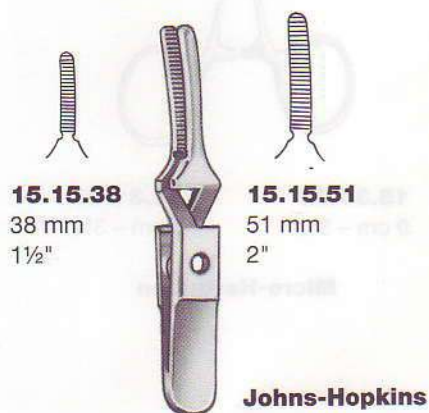
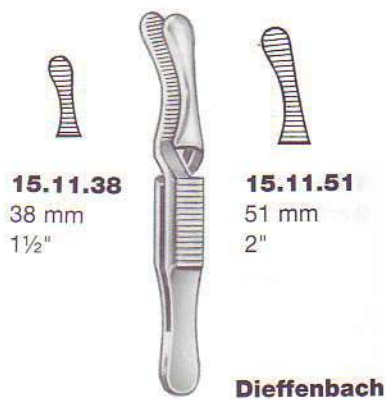
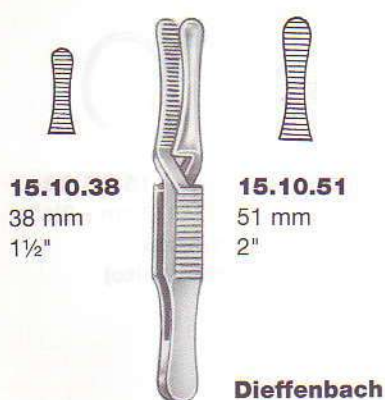

"AT" = atraumatische Riefung
atraumatic serrations
con estriado atraumático
avec striure atraumatique
striatura atraumatica



15.30.09
 9 cm - 3½"

Micro-Hartmann



15.32.09
 9 cm - 3½"

**Hartmann
 (Baby-Mosquito)**

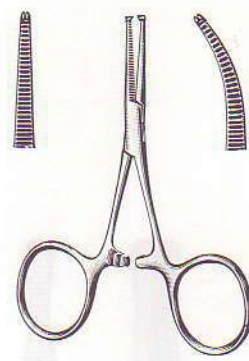

15.34.09
 9 cm - 3½"

**Hartmann
 (Baby-Mosquito)**



15.40.12
 12,5 cm - 5"

Micro-Halsted

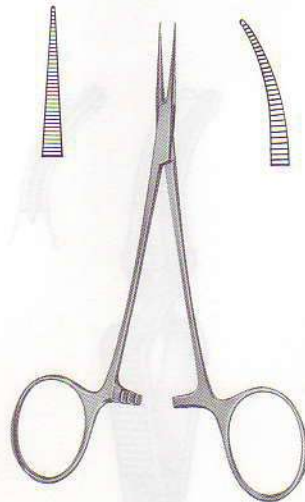

15.40.82
 12,5 cm - 5"

Jacobson-Micro



15.42.12
 12,5 cm - 5"

Micro-Halsted

15.41.12
 12,5 cm - 5"

15.41.82
 12,5 cm - 5"

15.43.12
 12,5 cm - 5"



"AT" = atraumatische Riefung
 atraumatic serrations
 con estrado atraumático
 avec striure atraumatique
 striatura atraumatica



15.44.12
 12,5 cm - 5"

Halsted-Mosquito



15.44.13
 12 cm - 4¾"

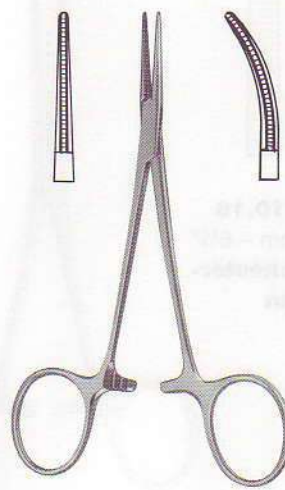

15.44.42
 12,5 cm - 5"

Mosquito "AT"



15.45.42
 12,5 cm - 5"

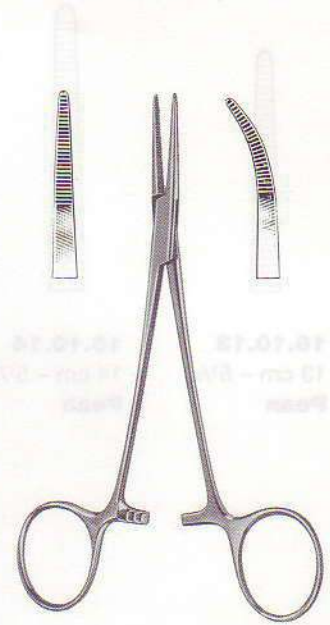

15.50.14
 14 cm - 5½"

Providence-Hospital

15.51.14
 14 cm - 5½"



15.56.15
 15 cm - 6"

Leriche

15.57.15
 15 cm - 6"



15.58.15
 15 cm - 6"

Leriche

15.59.15
 15 cm - 6"

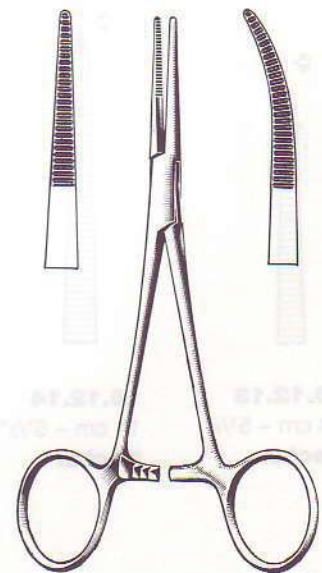

15.70.14
 14 cm - 5½"

Kelly

15.71.14
 14 cm - 5½"



16.10.13
 13 cm - 5 1/8"
Pean



16.10.14
 14 cm - 5 1/2"
Pean



16.10.16
 16 cm - 6 1/4"
Rochester-Pean



16.11.13
 13 cm - 5 1/8"
Pean



16.11.14
 14 cm - 5 1/2"
Pean

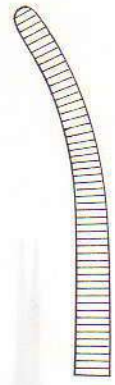

16.11.16
 16 cm - 6 1/4"
Rochester-Pean



16.12.13
 13 cm - 5 1/8"
Kocher



16.12.14
 14 cm - 5 1/2"
Kocher



16.12.16
 16 cm - 6 1/4"
Rochester-Ochsner



16.13.13
 13 cm - 5 1/8"
Kocher

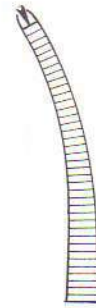

16.13.14
 14 cm - 5 1/2"
Kocher



16.13.16
 16 cm - 6 1/4"
Rochester-Ochsner



Präparier- und Ligaturklemmen
Dissecting and Ligature Forceps
Pinzas para preparaciones y para ligaduras
Pinces à préparations et à ligatures
Pinze per preparazione e per legatura

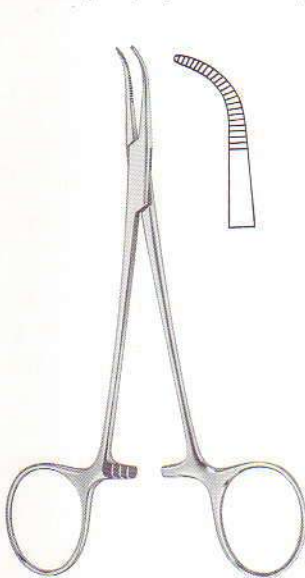

17.05.14
14 cm – 5½"
Adson-Baby



17.06.14
14 cm – 5½"
Mixer-Baby

Tuchklemmen
Towel Clamps
Pinzas de campo
Pinces pour fixer les compresses
Fissateli

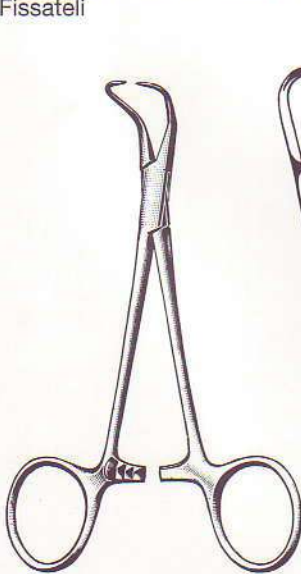

Backhaus



17.55.08
8,5 cm – 3¾"



17.55.10
10,5 cm – 4¼"

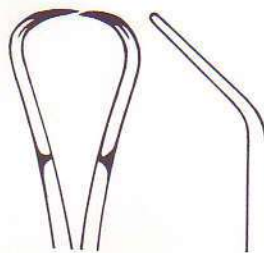

17.55.13
13 cm – 5¼"



17.55.20 11 cm – 4¾"
17.55.23 13 cm – 5¼"
Backhaus

Präparier- und Ligaturzangen
 Dissecting and Ligature Forceps
 Pinces pour préparations et pour ligatures
 Pinces à préparations et à ligatures
 Pinces per preparazioni e per legatura



Tuchklammer
 Towel Clamp
 Pinces de campo
 Pinces pour fixer les compresses
 Pinces



Bochmann



17.55.13
 10.5 cm

17.55.14
 10.5 cm



17.55.15
 13 cm - 5 1/4"

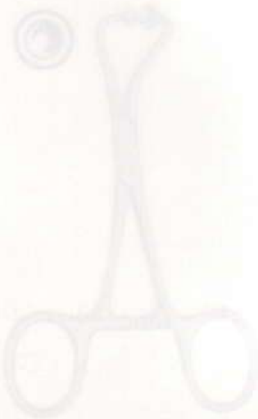

17.55.20 11 cm - 4 1/4"
 17.55.23 18 cm - 5 1/2"

Bochmann

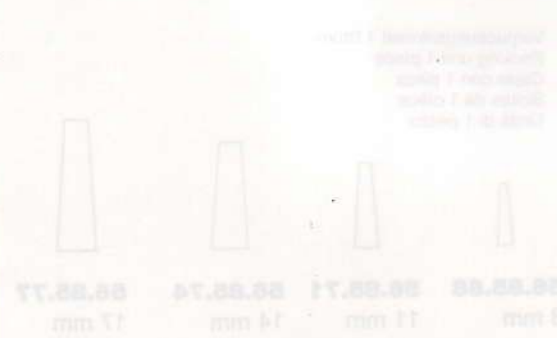

Mikro-Gefäßclips
Micro Vessel Clips
Micro Clips vasculares
Micro Clips vasculaires
Micro Clips vascolari



Acland

Einzelclip
 Single clip
 Clip suelto
 Clip simple
 Clip solo

Verpackungseinheit 2 Stück
 Packing unit 2 pieces
 Cajas con 2 piezas
 Boîtes de 2 pièces
 Unità di 2 pezzi

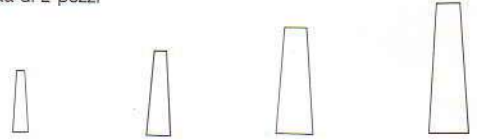

56.85.08 **56.85.11** **56.85.14** **56.85.17**
 8 mm 11 mm 14 mm 17 mm



Acland

Doppelclip fixiert
 Double Clip, fixed
 Clip doble, fijado
 Clip double, fixé
 Clip doppio, fisso

Verpackungseinheit 1 Stück
 Packing unit 1 piece
 Cajas con 1 pieza
 Boîtes de 1 pièce
 Unità di 1 pezzo

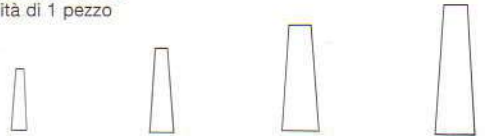

56.85.28 **56.85.31** **56.85.34** **56.85.37**
 8 mm 11 mm 14 mm 17 mm

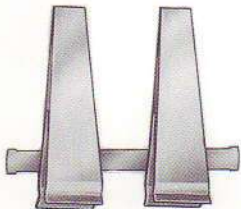

Acland

Approximator verstellbar
 Approximator, adjustable
 Aproximador ajustable
 Approximateur ajustable
 Approssimatore spostabile

Verpackungseinheit 1 Stück
 Packing unit 1 piece
 Cajas con 1 pieza
 Boîtes de 1 pièce
 Unità di 1 pezzo

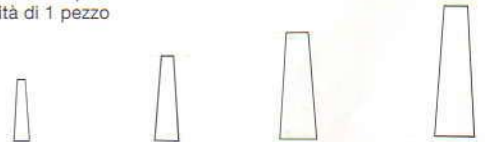

56.85.48 **56.85.51** **56.85.54** **56.85.57**
 8 mm 11 mm 14 mm 17 mm



Acland

Approximator verstellbar
 Approximator, adjustable
 Aproximador ajustable
 Approximateur ajustable
 Approssimatore spostabile

Verpackungseinheit 1 Stück
 Packing unit 1 piece
 Cajas con 1 pieza
 Boîtes de 1 pièce
 Unità di 1 pezzo

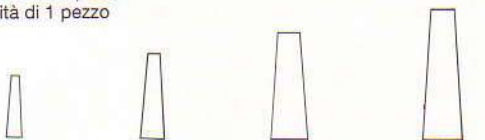

56.85.68 **56.85.71** **56.85.74** **56.85.77**
 8 mm 11 mm 14 mm 17 mm

für Clips
for Clips
para Clips
pour Clips
per Clips

8 - 11 mm

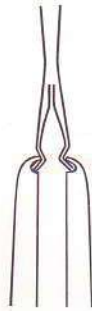

für Clips
for Clips
para Clips
pour Clips
per Clips

14 - 17 mm

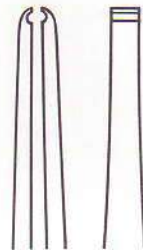

für Clips
for Clips
para Clips
pour Clips
per Clips

8 - 17 mm



56.85.91
14,5 cm - 5³/₄"
Acland



56.85.93
14,5 cm - 5³/₄"
Acland



56.85.98
11 cm - 4¹/₂"
Acland

für temporären Verschluss
 for temporary occlusion
 para oclusión temporal
 pour occlusion temporaire
 per chiusura temporaria

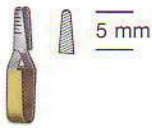

56.87.05
 20 g/mm³
Biemer



56.87.08
 18 g/mm³
Biemer



56.87.18
 21 g/mm³
Biemer



Anlegepinzette für
 Biemer Clips
 Applying Forceps for
 Biemer Clips
 Pinza aplicadora para
 clips de Biemer
 Pince pour poser les
 clips de Biemer
 Pinza per applicare
 i clips di Biemer

56.87.46
 14,5 cm - 5¾"
Biemer



56.87.38
Biemer

Approximator mit einstellbarem Clip-
 Abstand und Druck, komplett mit
 Schlüssel 56.87.49

Approximator with adjustable clip
 distance and pressure, complete with key
 56.87.49

Aproximador con distancia de clip
 y presión ajustable, completo con llave
 56.87.49

Approximateur, distance entre les clips
 et pression ajustables, complet avec clef
 56.87.49

Approssimatore con distanza per clip
 e pressione regolabile, completo con
 chiave 56.87.49



56.87.49
 Ersatzschlüssel für
 Approximator 56.87.38

Replacement Key for
 Approximator 56.87.38

Llave de repuesto para el
 aproximador 56.87.38

Clef de remplacement pour
 approximateur 56.87.38

Chiave di ricambio per
 approssimatore 56.87.38

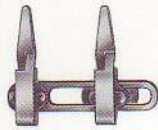

56.87.35
 13 g/mm²
Biemer

Approximator mit einstellbarem
 Clip-Abstand

Approximator with adjustable
 clip distance

Aproximador con distancia de
 clip ajustable

Approximateur, distance entre
 les clips ajustable

Approssimatore con distanza regolabile
 per clip

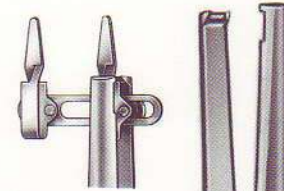

Anlegepinzette für Biemer
 Approximator 56.87.35

Applying Forceps for Biemer
 Approximator 56.87.35

Pinza aplicadora para Biemer
 Aproximador 56.87.35

Pince pour poser l'approximateur
 de Biemer 56.87.35

Pinza per applicare Biemer
 Approssimatore 56.87.35



56.87.47
 14,5 cm - 5¾"
Biemer

56.87.30

Biemer Approximator Set, bestehend aus Approximator 56.87.35
 und Anlegepinzette 56.87.47.

Biemer Approximator Set, consisting of Approximator 56.87.35
 and Applying Forceps 56.87.47.

Biemer set aproximador, compuesto por aproximador 56.87.35
 y pinza aplicadora 56.87.47.





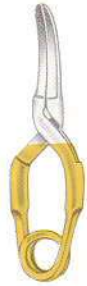

Jeu d'approximateurs de Biemer, comprenant: approximateur 56.87.35
 et pince 56.87.47.

Set Biemer approssimatore, composto da approssimatore 56.87.35
 e pinza per applicare 56.87.47.



Yasargil

für temporären Verschluss
 for temporary occlusion
 para oclusión temporal
 pour occlusion temporaire
 per chiusura temporaria

		Schließkraft g Closing pressure g Fuerza de cierre (g) Force de fermeture g Chiusura forte gr ± 10%	Öffnungsweite Opening Abertura Largeur d'ouverture Apertura mm	Maullänge Jaw length Longitud de la boca Longueur des mors Lunghezza del morso mm
 Standard	58.54.60	70	7,0	10
 Standard	58.55.60	70	6,8	10
 Standard	58.55.80	70	6,1	10
 Mini	58.56.58	70	4,6	7,7
 Mini	58.57.58	70	4,4	7,7
 Mini	58.57.68	70	4,0	7,7

Anlegezangen für Yasargil Clips
Applying Forceps for Yasargil Clips
Pinzas aplicadoras para clip de Yasargil
Pinces pour poser les clips de Yasargil
Pinze per applicare i clips di Yasargil

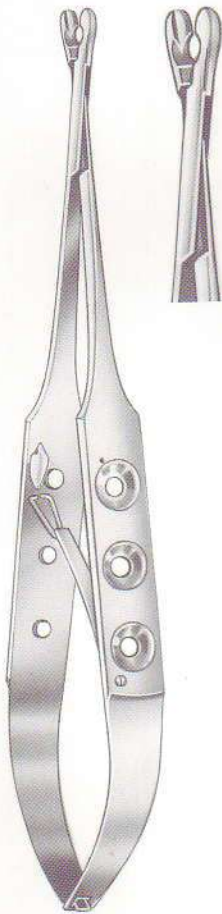

58.54.96
18 cm – 7¹/₈"
Standard
Yasargil



58.54.97
17 cm – 6³/₄"
Standard
Yasargil

58.56.96
18 cm – 7¹/₈"
Mini
Yasargil

58.56.97
17 cm – 6³/₄"
Mini
Yasargil

Gefäß-Spreizpinzette
Vessel Spreader
Pinza dilatador vascular
Pince-dilatateur vasculaire
Pinza per dilatazione vascolare



56.60.31
11 cm – 4¹/₂"

Clip-Anlagen, Oeß-Spreizpinzette
 Clip Applying Forceps, Vessel Spreader
 Pinces applicatrices de clips, Pinces dilatatrices vasculaires
 Pinces pour poser les clips, Pinces dilatatrices vasculaires
 Clip Pinces per applicatori, Pinze per dilatazione vascolare



Antennennenn für Yessigli Clips
 Applying Forceps for Yessigli Clips
 Pinces applicatrices pour clips Yessigli
 Pinces pour poser les clips Yessigli
 Pinze per applicare i clip Yessigli

1100



00.00.01
 17 cm - 5 1/2"



00.04.00
 18 cm - 7 1/4"
 Standard
 Yessigli



00.00.01
 17 cm - 5 1/2"
 Mini
 Yessigli

00.00.00
 18 cm - 7 1/4"
 Mini
 Yessigli



19.17.18
 15 cm - 5 7/8"
 Ulrich



19.17.19
 15 cm - 5 7/8"
 Ulrich

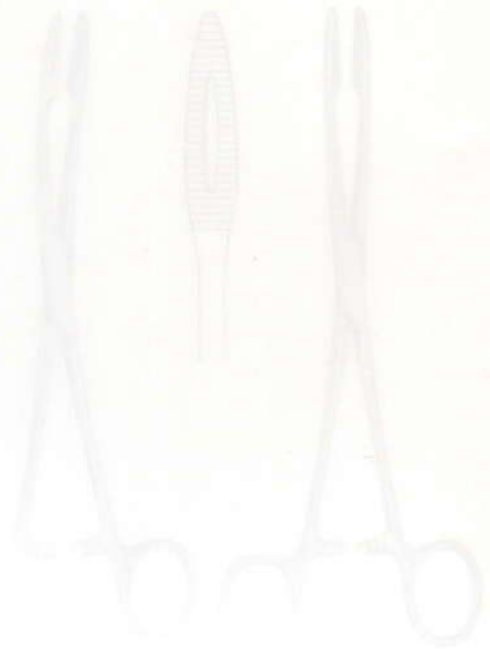

Kornzangen
 Dressing Forceps
 Pinzas para curaciones
 Pincès à pansements
 Pinze per medicazione

**Kornzangen
 Tupferzangen**

**Dressing Forceps
 Cotton Swab Forceps**

**Pinzas para curaciones
 Pinzas porta-tapones**

**Pincès à pansements
 Pincès porte-tampons**

**Pinze per medicazione
 Pinze per tamponamento**



19.17.18
 15 cm - 5 7/8"
 Ulrich

19.17.19
 15 cm - 5 7/8"
 Ulrich



Kornzangen
 Dressing Forceps
 Pinzas para curaciones
 Pinces à pansements
 Pinze per medicatura

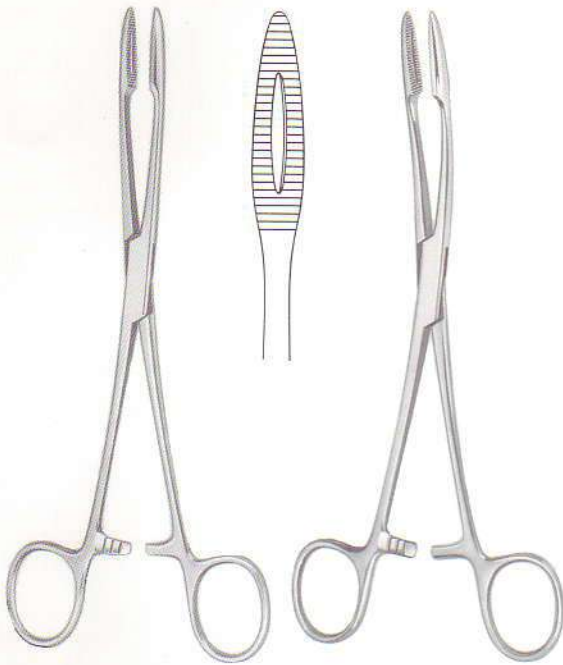

19.16.20
 20 cm - 8"
Gross

19.17.20
 20 cm - 8"
Gross

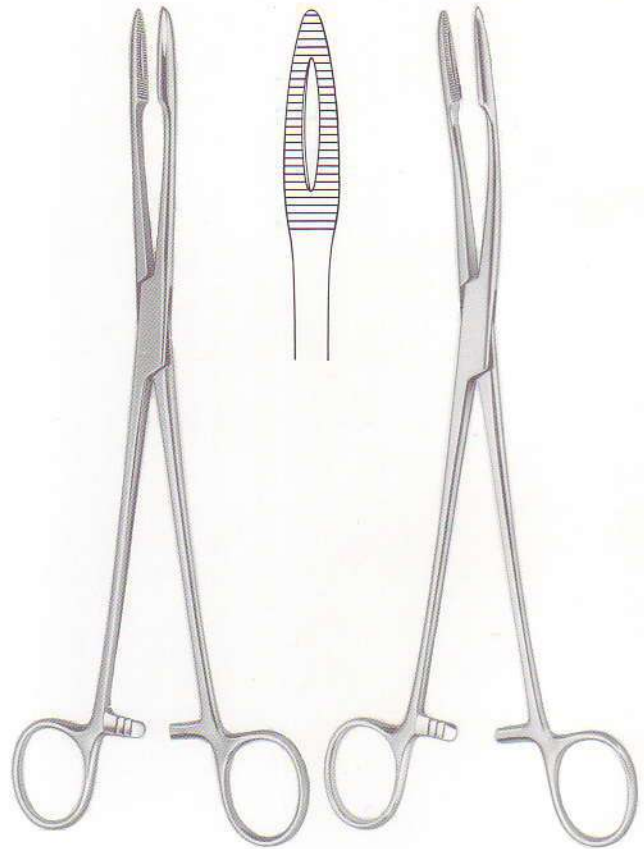

19.16.26
 26 cm - 10¼"
Maier

19.17.26
 26 cm - 10¼"
Maier

Tupferzangen
 Cotton Swab Forceps
 Pinzas porta-tapones
 Pinces porte-tampons
 Pinze per tamponamento



19.40.18
 18 cm - 7⅛"
Ulrich

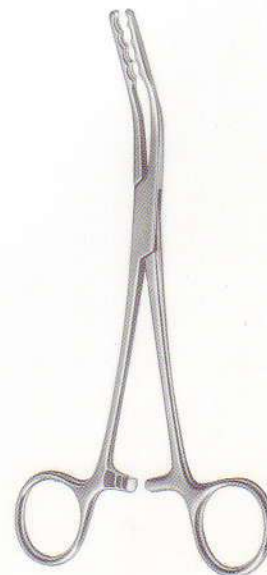
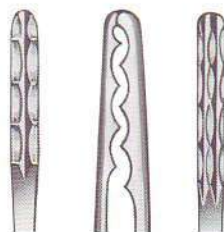

19.41.18
 18 cm - 7⅛"
Ulrich



20.02.02
18 cm - 6W*



20.02.03
18 cm - 1



20.02.12



20.02.13



18 cm - 6W*



20.02.08



20.02.09



18 cm - 6W*

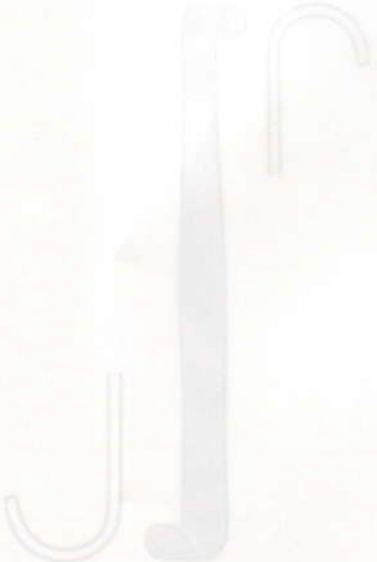

20.02.11
11 cm - 6W*



20.07.08
11 cm - 6W*



20.07.07
11 cm - 6W*



Wundhaken
Retractors
Separadores
Ecarteurs
Divaricatori



20.05.08

16 cm - 6 1/4"
Senn-Miller



20.05.12

16 cm - 6 1/4"
Mathieu



20.05.13



20.05.25
 16 cm - 6 1/4"
Ragnell



20.05.50
 18 cm - 7 1/8"
Cope

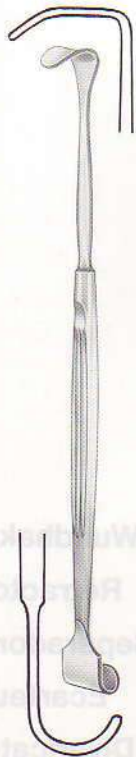

20.07.07
 17 cm - 6 3/4"
Lukens



20.07.08
 17 cm - 6 3/4"
Jackson

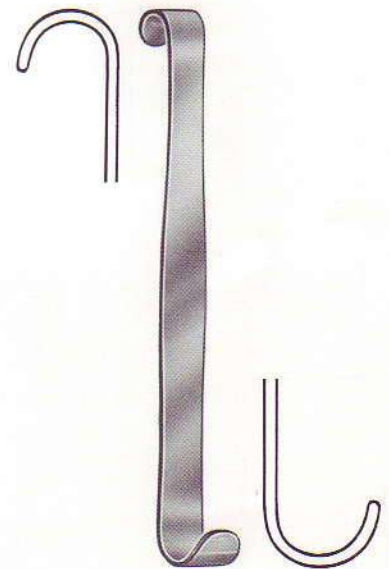

20.09.11
 11 cm - 4 3/8"
Luer



20.09.50
16 cm – 6 1/4"
Rose



18 cm – 7 1/8"
Meyerding



20.10.01
7 x 18 mm



20.10.02
5 x 16 mm



20.10.03
4 x 7 mm



20.10.04
3 x 10 mm



20.10.05
4 x 7 mm



20.10.06
10 x 4 mm



20.12.10
6 x 10 mm



20.12.20
6 x 20 mm

14 cm – 5 1/2"
Senn-Green



3 x 15 mm

20.12.18
18 cm – 7 1/8"
Mod. Lanz



20.12.25
6 x 25 mm



20.12.26
8 x 25 mm

17 cm – 6 3/4"
Langenbeck-Green

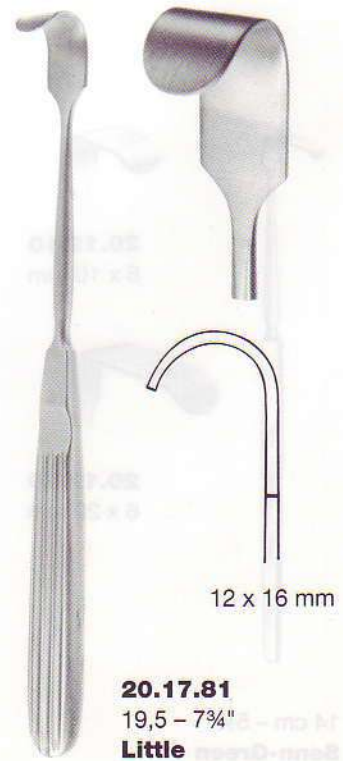
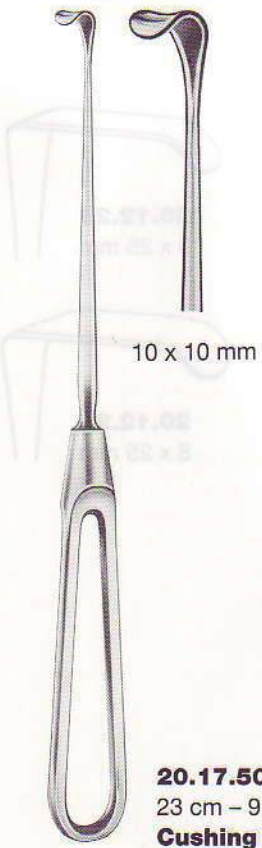
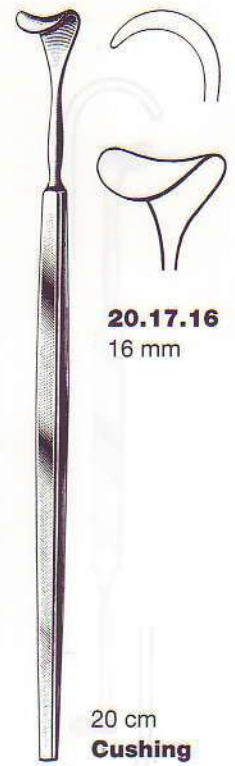
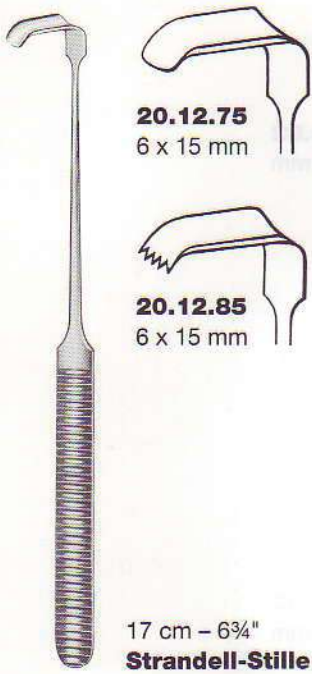



20.20.12
 13 cm - 5 1/8"
Moldestad



20.20.17
 5 mm



20.20.18
 7 mm

17 cm - 6 3/4"



4 mm

20.20.34
 16 cm - 6 1/4"



20.20.57
 7 mm



20.20.59
 9 mm

16 cm - 6 1/4"



20.22.01



20.22.02



20.22.03

14 cm - 5 1/2"
Lucae



20.22.31
 4 mm



20.22.32
 6 mm

19 cm - 7 1/2"
Cushing



20.22.36
 4 mm



20.22.37
 6 mm

28 cm - 11"
Cushing



20.30.12
12,5 cm - 5"
Frazier

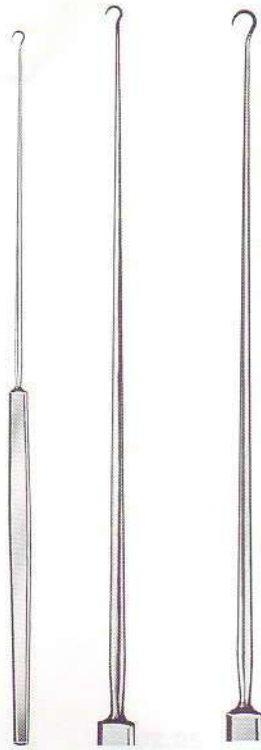

20.30.19 20.30.20
19 cm - 7½"
Gillies



20.31.13
13 cm - 5⅛"
Straight



20.31.15
13 cm - 5⅛"
Lahey Clinic



20.35.01
15 cm - 6"
Barsky

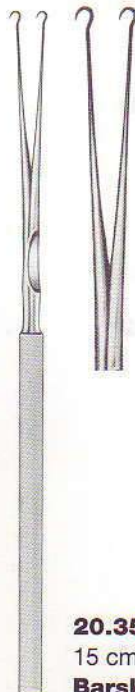

20.35.02
15 cm - 6"
Barsky

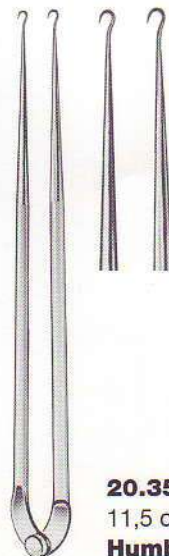

20.35.32
11,5 cm - 4½"
Humby



20.40.15
15 cm - 6"
News



20.40.16
16 cm - 6¼"
Cottle

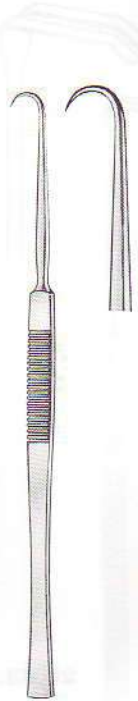

20.45.14
14 cm - 5½"
Bergmann



20.45.16
16,5 cm - 6½"



13 cm - 5⅛"
Kleinert-Kutz



20.48.03
3 mm



20.48.05
5 mm



20.48.07
7 mm



20.50.01
16 cm - 6¼"
Joseph



16 cm - 6¼"
Joseph



20.50.02
2 mm



20.50.05
5 mm

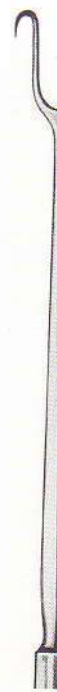

20.50.07
7 mm



20.50.10
10 mm

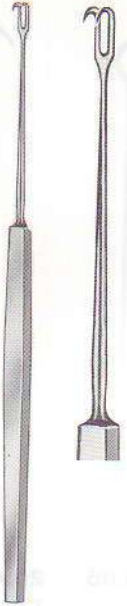

20.52.02
15 cm - 6"
Freer



20.52.10
13 cm - 5 1/8"
Guthrie



20.52.11
13 cm - 5 1/8"
Guthrie



20.53.50
16 cm - 6 1/4"

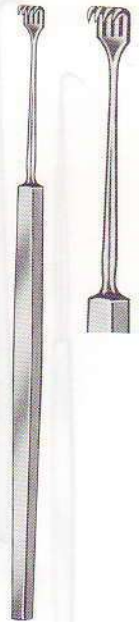

20.55.13
13 cm - 5 1/8"
Rollet



20.55.16
16 cm - 6 1/4"
Knapp



20.55.17
16 cm - 6 1/4"
Knapp



20.55.19
19 cm - 7 1/2"
Mod. Lanz



20.55.33
16 cm - 6 1/4"
Machatt



20.55.43
16 cm - 6 1/4"
Machatt



17 cm - 6³/₄"



20.60.01



20.60.02

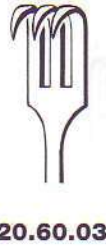

20.60.03

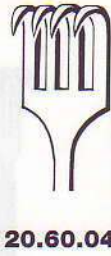

20.60.04



20.61.01



20.61.02

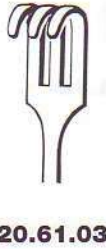

20.61.03



20.61.04



16 cm - 6¹/₄"



20.64.01



20.64.02

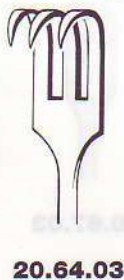

20.64.03



20.64.04



16 cm - 6¹/₄"



20.65.01



20.65.02

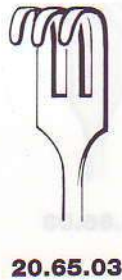

20.65.03

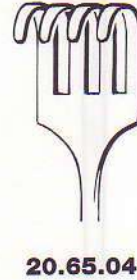

20.65.04



20.64.52



20.64.53



20.65.52



20.65.53



20.65.75
 16 cm - 6 1/4"

16 cm - 6 1/4"

16 cm - 6 1/4"



20.66.01



20.66.02



20.66.03



20.66.04



20.67.01



20.67.02



20.67.03

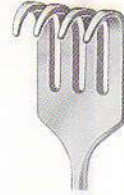

20.67.04

16 cm - 6 1/4"

16 cm - 6 1/4"

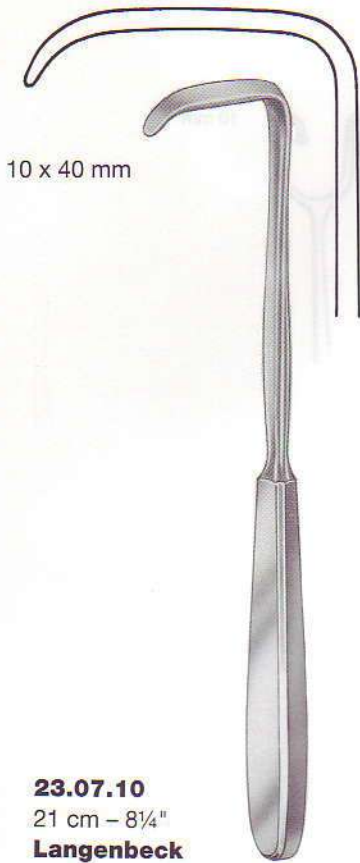

scharf
sharp
agudo
tranchant
tagliente

stumpf
blunt
romo
mousse
smussa



60.22.02 60.22.03

12 cm - 4¾"
Tyrell



60.22.51 60.22.52 60.22.53

14 cm - 5½"
Graefe

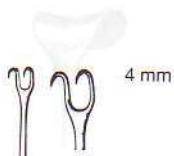

67.20.06
 mm 67 - 06

06

67.20.06
 mm 07 - 06



67.20.05
 mm 07 - 05



67.20.05
 mm 07 - 05



67.20.03
 15 cm - 6"
Cottle



67.20.25
 17 cm - 6¾"
Fomon



mm 04 x 07

67.20.25
 mm 17 - 25
 Fomon



67.20.23
 mm 55 - 23

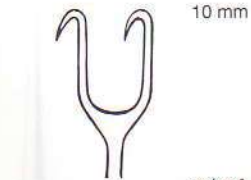

scharf
 sharp
 agudo
 tranchant
 tagliente

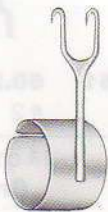

67.20.23
 5,5 cm - 2 1/8"
Millard (Cottle)

Fingerringhäkchen
 "Finger-ring" Retractor
 Ganchito del anillo para dedo
 Crochet en forme de bague
 Uncino d'anello per dito

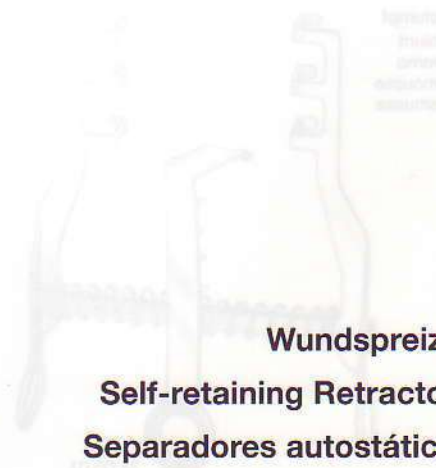

Wundspreizer
Self-retaining Retractors
Separadores autostáticos
Ecarteurs autostatiques
Divaricatori autostatici

scharf
sharp
agudo
tranchant
tagliente



24.04.05

5 cm - 2"
Finsen

stumpf
blunt
romo
mousse
smussa

24.04.06

scharf
sharp
agudo
tranchant
tagliente

24.04.07



stumpf
blunt
romo
mousse
smussa

24.04.08

7 cm - 2³/₄"
Finsen

stumpf
blunt
romo
mousse
smussa



24.04.18
7 cm - 2³/₄"
Finsen modif.

scharf
sharp
agudo
tranchant
tagliente

24.05.57

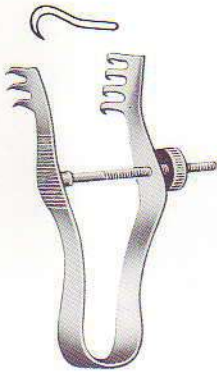

7 cm - 2³/₄"
Finsen

stumpf
blunt
romo
mousse
smussa

24.05.58

stumpf
blunt
romo
mousse
smussa

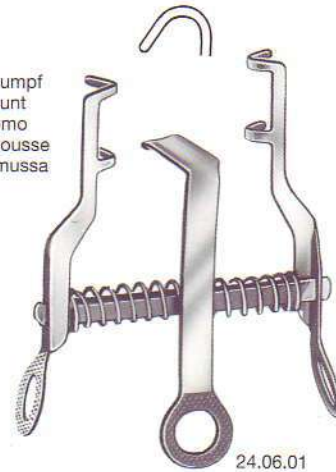

24.06.01

24.06.00
komplett, complete, completo, complet

stumpf
blunt
romo
mousse
smussa

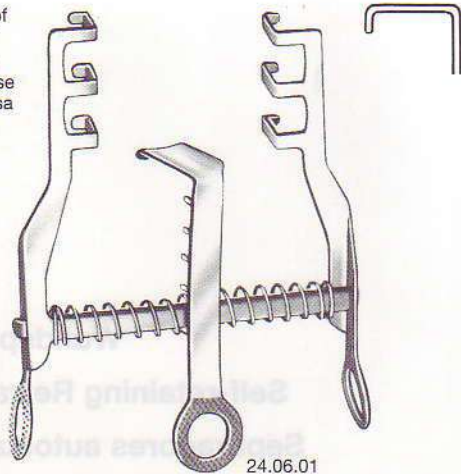

24.06.01

24.07.00

komplett, complete, completo, complet

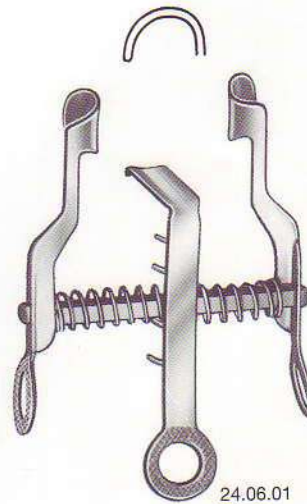

24.06.01

24.08.00

komplett, complete, completo, complet



Mittelvalven allein zu 24.06.00, 24.07.00, 24.08.00
Center valves for 24.06.00, 24.07.00, 24.08.00
Valvas centrales sueltas para 24.06.00, 24.07.00, 24.08.00
Valves centrales seules pour 24.06.00, 24.07.00, 24.08.00
Valve centrali sole per 24.06.00, 24.07.00, 24.08.00

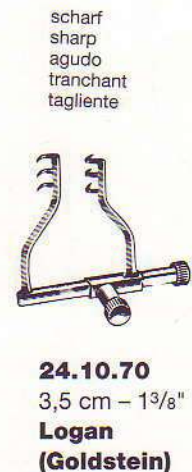
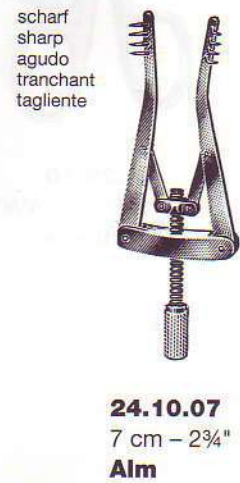
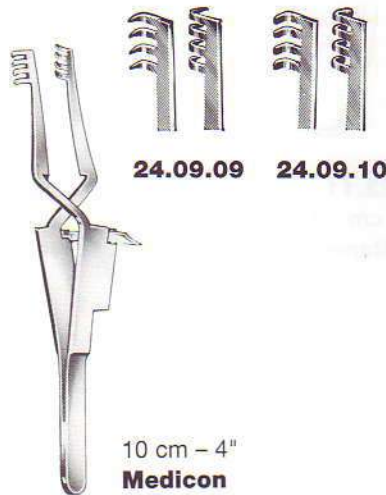



24.22.10
 10,5 cm - 4 1/8"
Weitlaner



24.22.11
 10,5 cm - 4 1/8"
Weitlaner



24.22.13
 13 cm - 5 1/8"
Weitlaner

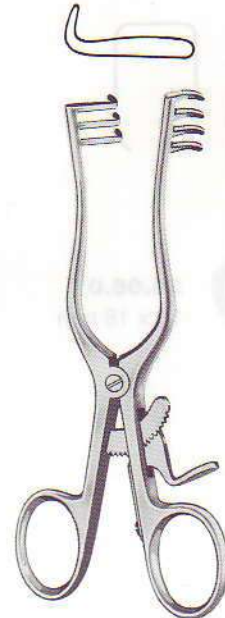

24.22.14
 13 cm - 5 1/8"
Weitlaner

Fingerspreizer
 Finger Spreader
 Separador para dedos
 Ecarteur à doigts
 Divaricatore per le dita



43.49.01
 8 cm - 3 1/8"



43.49.02
 10 cm - 4"



25.07.05
13 1/2"
10 cm - 7 1/2"
Black



25.07.05
13 1/2"
10 cm
Black



25.07.05
11 cm - 4 1/2"
Black



07.05.10
18 cm - 7 1/4"
Black



07.05.10
18 cm - 7 1/4"
Black

**Knochenfeilen
Knochenraspeln**

**Bone Files
Bone Rasps**

**Limas para huesos
Escofinas para huesos**

**Limes à os
Râpes à os**

**Lime per ossa
Raspe per ossa**



26.01.11
 11 cm - 4³/₈"
Black

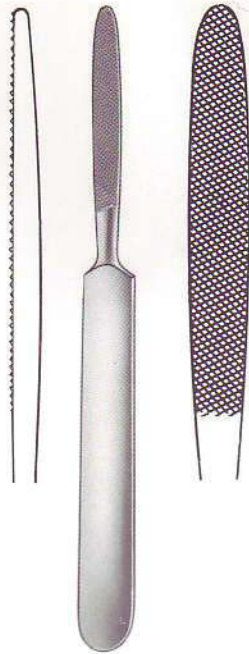

26.05.22
 # 2
 16 cm - 6¹/₄"
Joseph



26.10.12
 # 12
 18 cm - 7¹/₈"
Miller

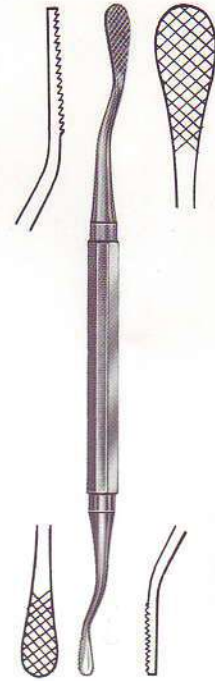

26.10.22
 # 12 C
 18 cm - 7¹/₈"
Miller

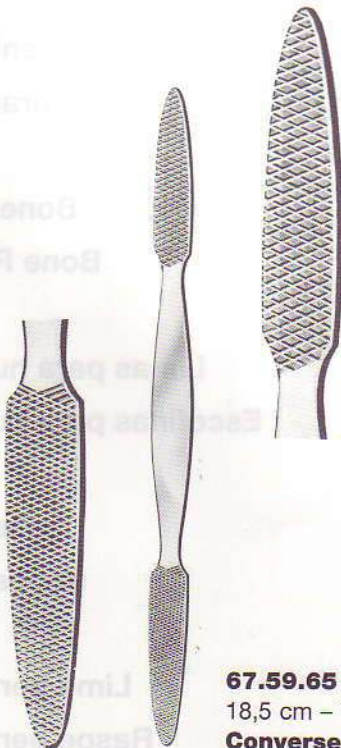

67.59.65
 18,5 cm - 7¹/₄"
Converse

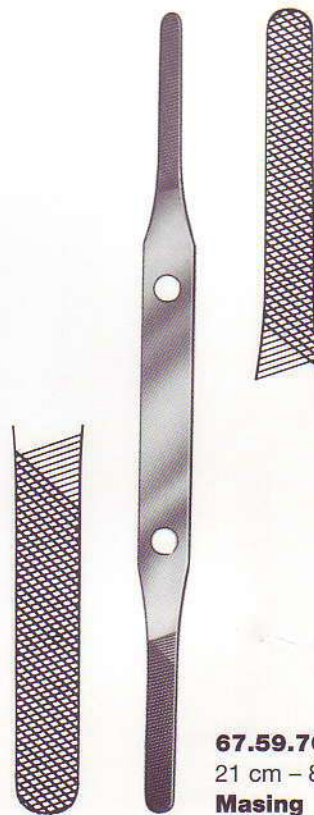

67.59.70
 21 cm - 8¹/₄"
Masing



26.05.13
14 cm – 5 1/8"



19 cm – 7 1/8"
Gallaher

26.05.41
1



26.05.42
2



26.05.43
3

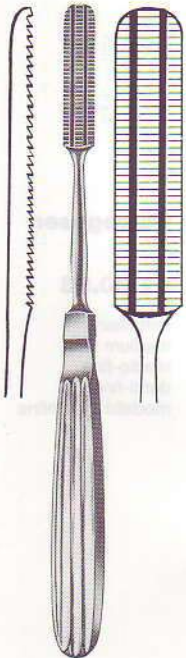

67.59.25
18 cm – 7 1/8"
Maltz

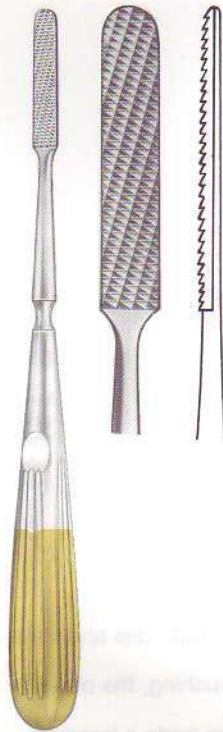

67.59.36
20,5 cm – 8"
Cottle "HM"

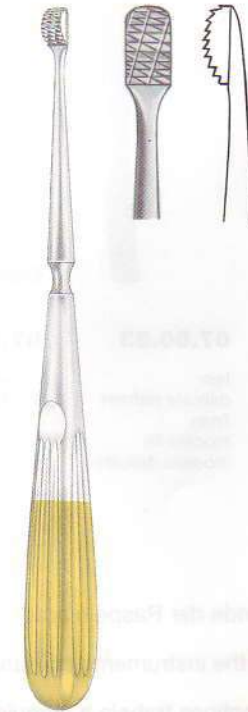

67.59.50
19,5 cm – 7 3/4"
Lewis "HM"

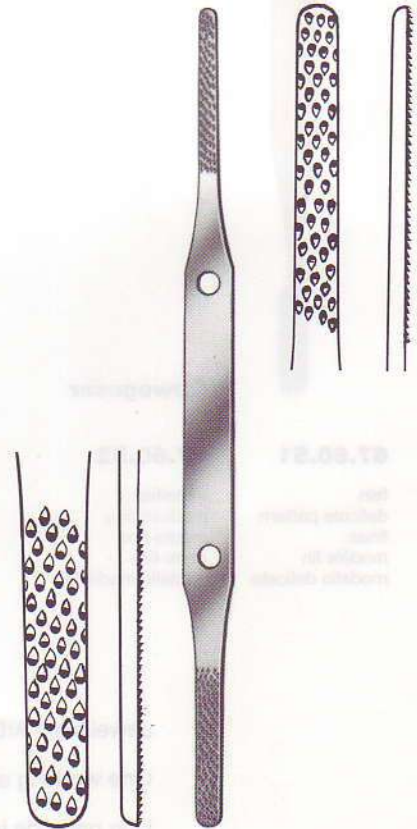

67.59.71
22 cm – 8 3/4"
Masing

Die Knochenspäne werden durch die Perforationen nach außen abgedrängt, wodurch die Raspeln nicht verstopfen und einfacher zu reinigen sind.

Bone splinters are pushed through the perforated working ends. This avoids plugging of the rasps and they can be cleaned easily.

Las limaduras de huesos son apartadas por las perforaciones hacia fuera; así no se atascan las escofinas y pueden ser limpiadas más fácil.

Les copeaux d'os sont poussés vers l'extérieur à travers les perforations, ceci évite un bouchage et facilite un meilleur nettoyage.

I trucioli delle ossa verranno eliminati fuori dalla perforazione poichè le raspe non si otturano e sono facilmente pulibili.



Obwegeser

67.60.51

fein
delicate pattern
finas
modèle fin
modello delicato

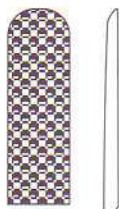

67.60.52

mittelfein
medium fine
medio-fina
demi-fine
modello mediofine



Obwegeser

67.60.53

fein
delicate pattern
finas
modèle fin
modello delicato



67.60.54

mittelfein
medium fine
medio-fina
demi-fine
modello mediofine



Obwegeser

67.60.55

fein
delicate pattern
finas
modèle fin
modello delicato



67.60.56

mittelfein
medium fine
medio-fina
demi-fine
modello mediofine

Jeweils ein Arbeitsende der Raspeln arbeitet auf Schub, das andere auf Zug.

One working end of the instruments operates by pushing, the other by pulling.

Una parte de las escofinas trabaja a empuje, la otra parte a tracción.

Un bout coupe en poussant, l'autre en tirant.

Una parte lavorativa della raspa funziona da spinta e l'altra da trazione.



20 cm - 8"
Fomon "HM"



1



3



5



7



9



2



4



6



8



10

67.60.60

67.60.61

67.60.62

67.60.63

67.60.64



07.00.04

07.00.05

07.00.06

07.00.07

07.00.08

Forceps 20 cm



YO.50.02
mm 5



YO.45.05
mm 3,8



YO.45.06
mm 3,8



YO.50.02
mm 5
18,5 cm - 7,3"

mm 5



**Elevatori
Raspatori**

**Bone Elevators
Raspatories**

**Elevadores
Legras**

**Elévateurs
Rugines**

YO.50.02
mm 5
18,5 cm - 7,3"

YO.50.02
mm 5
18,5 cm - 7,3"



YO.50.02
mm 5
18,5 cm - 7,3"

YO.50.02
mm 5
18,5 cm - 7,3"

**Elevatori
Periostotomi**

4 mm

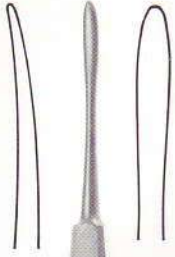

stumpf
 blunt
 romo
 mousse
 smussa

26.23.04
 16,5 cm – 6 1/2"
Sebileau



stumpf
 blunt
 romo
 mousse
 smussa

16 cm – 6 1/4"
Williger

26.24.04
 4 mm

26.24.05
 5,5 mm

26.24.07
 7 mm

5 mm

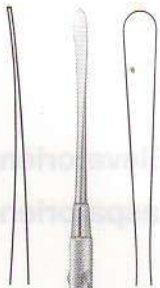

scharf
 sharp
 cortante
 tranchant
 tagliente



stumpf
 blunt
 romo
 mousse
 smussa

26.35.02
 19 cm – 7 1/2"
Freer

6,5 mm

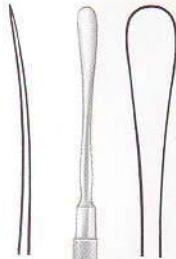

scharf
 sharp
 cortante
 tranchant
 tagliente

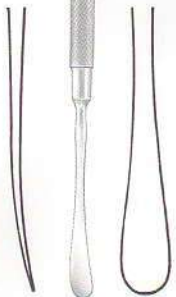

stumpf
 blunt
 romo
 mousse
 smussa

26.35.03
 19 cm – 7 1/2"
Freer

5 mm

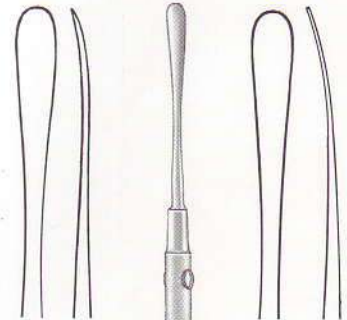

scharf
 sharp
 cortante
 tranchant
 tagliente

66.53.01



stumpf
 blunt
 romo
 mousse
 smussa

66.53.02

19,5 cm – 7 3/4"
Freer

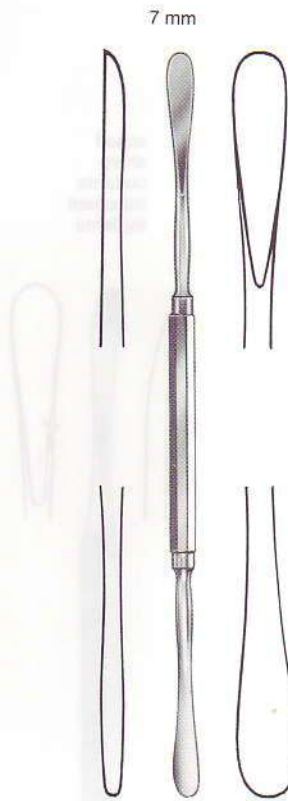

scharf
sharp
cortante
tranchant
tagliente

stumpf
blunt
romo
mousse
smussa

66.54.30
20 cm - 8"
Hajek-Ballenger



67.16.23
23 cm - 9"
Cottle

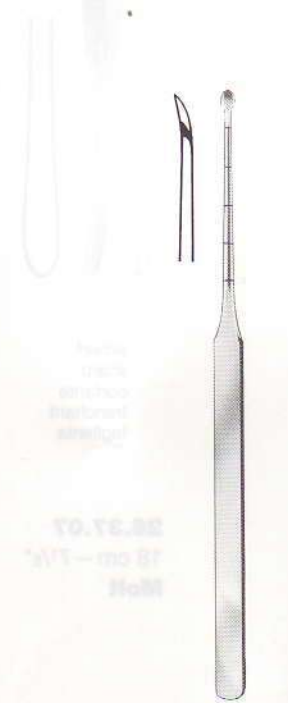

67.16.12
2,5 mm

67.16.12
2,5 mm
18 cm - 7 1/8"
Hohl



67.16.13
3 mm

67.16.13
3 mm
18 cm - 7 1/8"
Hohl



67.16.14
4 mm

67.16.14
4 mm
18 cm - 7 1/8"
Hohl

16 cm - 6 1/4"
Cottle

scharf
 sharp
 cortante
 tranchant
 tagliente

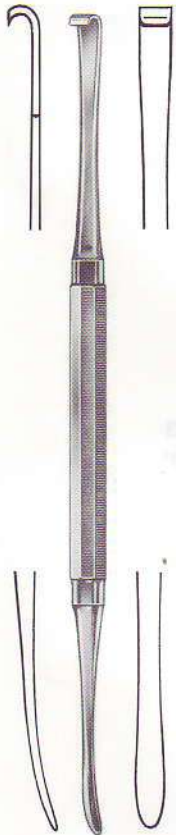

stumpf
 blunt
 romo
 mousse
 smussa

26.37.01
 18 cm - 7 1/8"
Molt

scharf
 sharp
 cortante
 tranchant
 tagliente



stumpf
 blunt
 romo
 mousse
 smussa

26.37.02
 18 cm - 7 1/8"
Molt

scharf
 sharp
 cortante
 tranchant
 tagliente

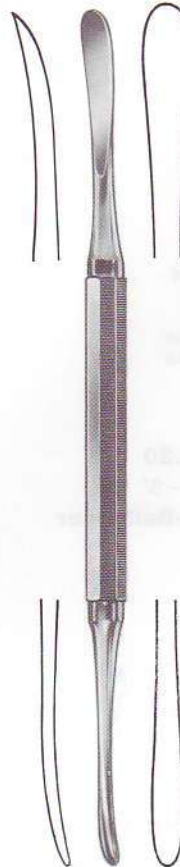

stumpf
 blunt
 romo
 mousse
 smussa

26.37.03
 18 cm - 7 1/8"
Molt

scharf
 sharp
 cortante
 tranchant
 tagliente



scharf
 sharp
 cortante
 tranchant
 tagliente

26.37.07
 18 cm - 7 1/8"
Molt

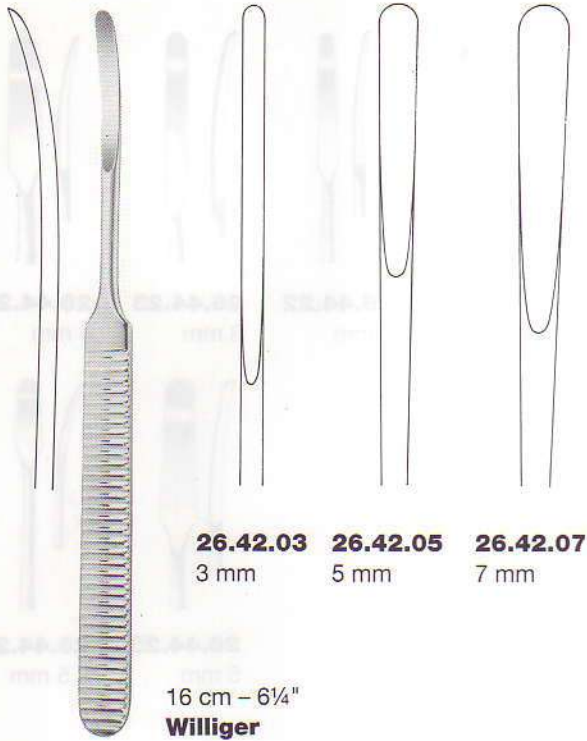

26.42.03 3 mm
26.42.05 5 mm
26.42.07 7 mm

16 cm - 6 1/4"
Williger

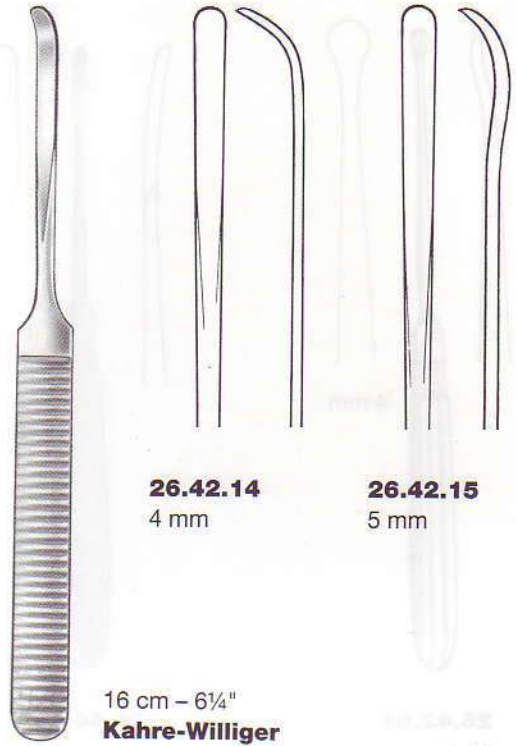

26.42.14 4 mm
26.42.15 5 mm

16 cm - 6 1/4"
Kahre-Williger

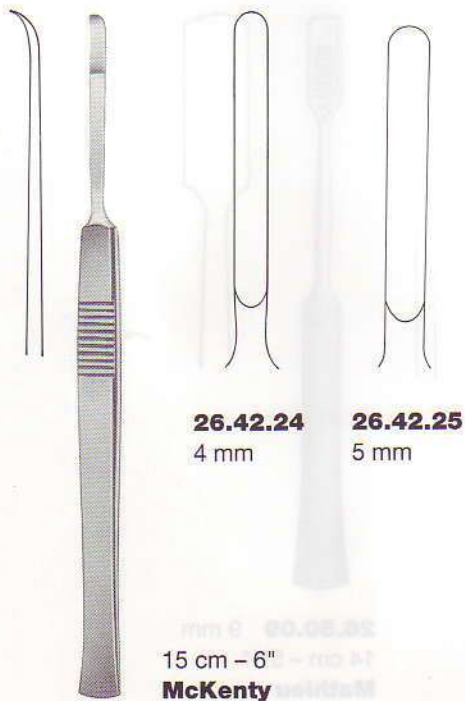

26.42.24 4 mm
26.42.25 5 mm

15 cm - 6"
McKenty



26.42.34
15,5 cm - 6 1/8"

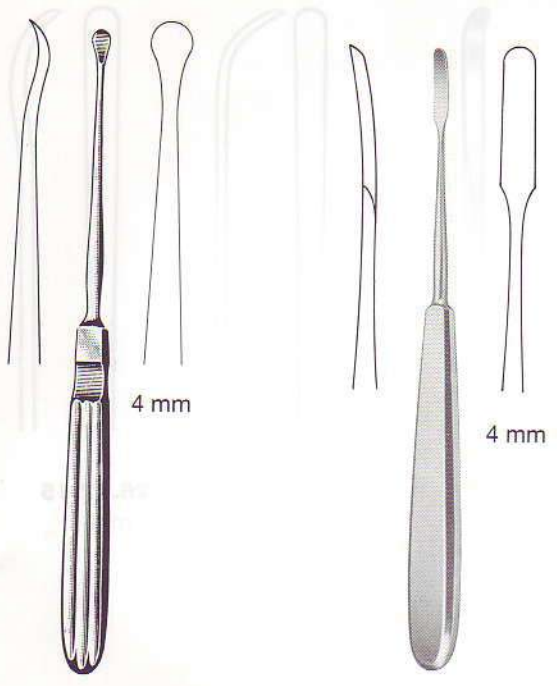

26.42.64
 19 cm - 7½"
Ward

26.44.04
 16,5 cm - 6½"
Joseph



17 cm - 6¾"
Lempert

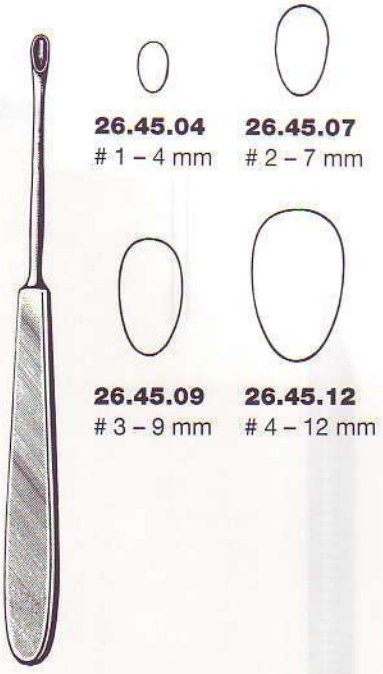

17 cm - 6¾"
Wiberg

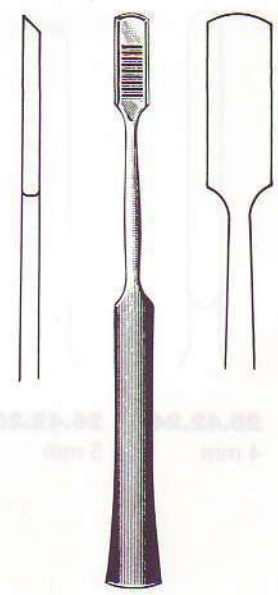

26.50.09 9 mm
 14 cm - 5½"
Mathieu

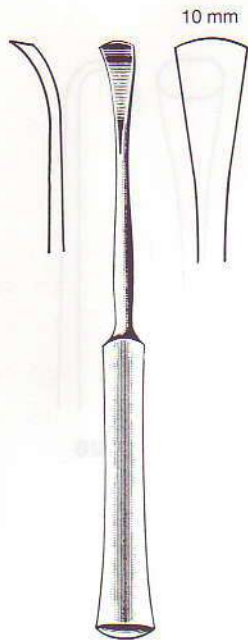

26.50.70
14,5 cm - 5¾"
Hylin

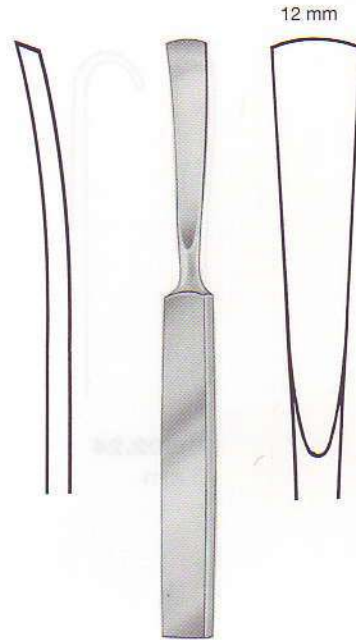

26.60.30
16 cm - 6¼"
Mod. Lanz



26.64.06
18,5 cm - 7¼"



26.64.13
18,5 cm - 7¼"

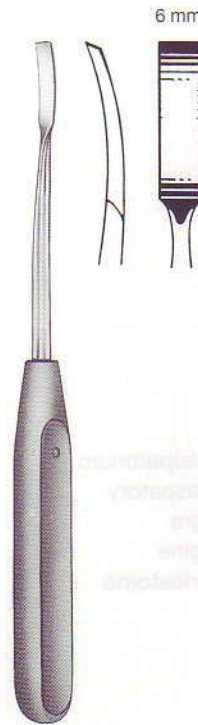

26.64.16
18,5 cm - 7¼"

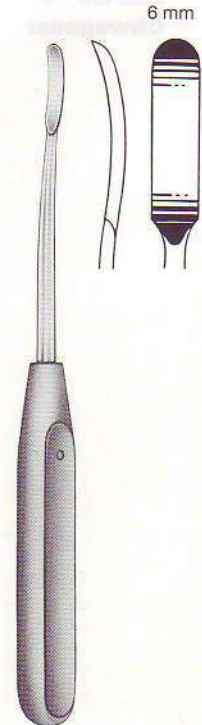

26.64.26
18,5 cm - 7¼"



20,5 cm – 8"
Obwegeser

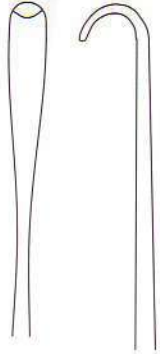

68.02.24
 5 mm

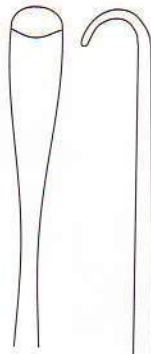

68.02.25
 7 mm

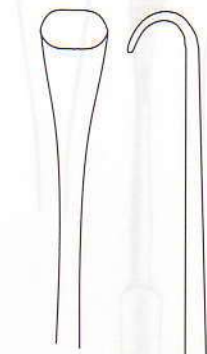

68.02.26
 9 mm

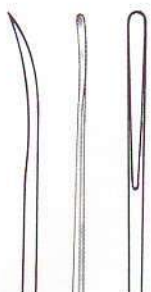

2,5 mm

halbscharf
 semi-sharp
 semi-agudo
 semitranchant
 semitagliente

Mikro-Raspatorium
 Micro Raspatory
 Microlegra
 Microrugine
 Microperiostomo



58.30.17
 18,5 cm – 7¼"
Yasargil

Dissektor
 Dissector
 Dissectore
 Dissecteur
 Dissettori

Dissektor
 Dissector
 Dissectore
 Dissecteur
 Dissettori

**Dissektoren
 Knochenträger
 Periostmesser**

**Dissectors
 Bone Curette
 Periosteal Knife**

**Dissectores
 Cuchilla ósea
 Cuchillo para periostio**

**Dissecteurs
 Curette à os
 Périostotome**

**Dissettori
 Cucchiaio ossivo
 Coltello staccaperiostio**

Dissektoren
 Dissectors
 Disectores
 Dissecteurs
 Dissettori

Knochenkürette
 Bone Curette
 Cucharilla ósea
 Curette à os
 Cucchiaino ossivoro

Periostmesser
 Periosteal Knife
 Cuchillo para periostio
 Périostotome
 Coltello staccaperiostio

stumpf
 blunt
 romo
 mousse
 smussa

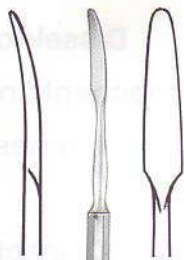

scharf
 sharp
 cortante
 tranchant
 tagliente

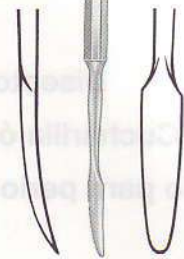

26.37.16
 16,5 cm - 6½"
Mod. Lanz

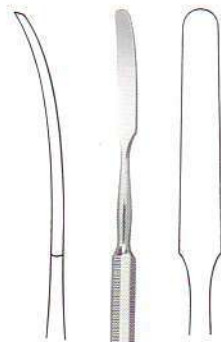

stumpf
 blunt
 romo
 mousse
 smussa



26.37.90
 19 cm - 7½"
MacDonald

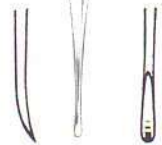
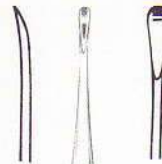

26.39.09
 17,5 cm - 7"
Miller

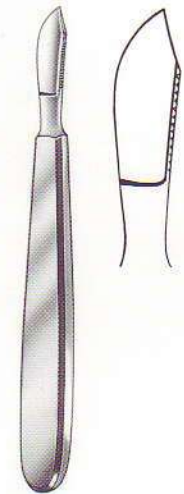

62.60.10
 13 cm - 5⅛"
Muck

Ø 20 mm
100 g



27.02.10
16,5 cm – 6 1/2"

Ø 20 mm
140 g



27.02.13
16,5 cm – 6 1/2"

bleigefüllt
lead filled head
relleno de plomo
remplie de plomb
guarnito di piombo

Ø 26 mm
180 g



27.04.20
21 cm – 8 1/4"
Hajek

Ø 30 mm
170 g



27.04.90
20 cm – 8"
Doyen

Ø 25 mm
200 g

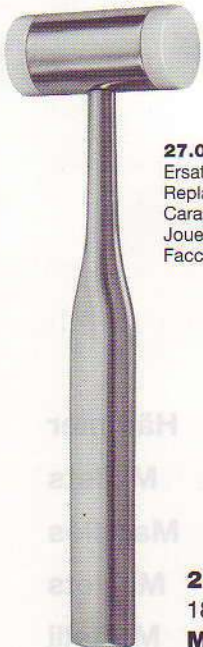

27.06.21
Ersatzbacken zu 27.06.20, Paar
Replaceable facings to 27.06.20, pair
Caras frontales de repuesto para 27.06.20, par
Joues de rechange pour 27.06.20, paires
Facce di ricambio per 27.06.20, paio

27.06.20
18,5 cm – 7 1/4"
Medicon

Ø 35 mm
150 g



aus NOVOTEX-Kunststoff (im Autoklaven
sterilisierbar bis 143° C bei 3 bar)
made of NOVOTEX plastic (sterilizable in
autoclave up to 143° C at 3 bar)
de materia plástica NOVOTEX (autoclavable
hasta 143° C bajo presión de 3 atmósferas)
en matière plastique NOVOTEX (stérilisable dans
l'autoclave jusqu'à 143° C sous pression de 3 bars)
di materia plastica NOVOTEX (autoclavabile fino
a 143° C, sotto pressione di 3 barie)

27.10.31
26 cm – 10 1/4"



**Meißel
Osteotome**

**Chisels
Osteotomes**

**Cinceles
Osteótomos**

**Ciseaux-burins
Ostéotomes**

**Scalpelli
Osteotomi**



27.57.02	2 mm	27.57.10	10 mm
27.57.04	4 mm	27.57.12	12 mm
27.57.06	6 mm	27.57.15	15 mm
27.57.08	8 mm		

13 cm – 5¹/₈"
Mini-Lambotte



27.57.52	2 mm	27.57.60	10 mm
27.57.54	4 mm	27.57.62	12 mm
27.57.56	6 mm	27.57.65	15 mm
27.57.58	8 mm		

17 cm – 6³/₄"
Mini-Lambotte

27.57.90

Satz von 7 MINI-LAMBOTTE
Osteotomen, 2 – 15 mm breit,
13 cm lang, in Segeltuchetui

Set of 7 MINI-LAMBOTTE
Osteotomes, 2 thru 15 mm
wide, **13 cm – 5¹/₈"**
in canvas roll

Juego de 7 osteótomos
MINI-LAMBOTTE, 2 a 15 mm
de ancho, **13 cm** de largo,
en bolsa de lona

Série de 7 MINI-Ostéotomes
de Lambotte, 2 à 15 mm de large,
13 cm de long, en housse de toile

Serie di 7 MINI-Osteotomi di
LAMBOTTE, largh. mm. 2 a 15,
lunghezza **cm. 13**
in cústodia di tela

27.57.95

Satz von 7 MINI-LAMBOTTE
Osteotomen, 2 – 15 mm breit,
17 cm lang, in Segeltuchetui

Set of 7 MINI-LAMBOTTE
Osteotomes, 2 thru 15 mm
wide, **17 cm – 6³/₄"**
in canvas roll

Juego de 7 osteótomos
MINI-LAMBOTTE, 2 a 15 mm
de ancho, **17 cm** de largo,
en bolsa de lona

Série de 7 MINI-Ostéotomes
de Lambotte, 2 à 15 mm de large,
17 cm de long, en housse de toile

Serie di 7 MINI-Osteotomi di
LAMBOTTE, largh. mm. 2 a 15,
lunghezza **cm. 17**
in cústodia di tela

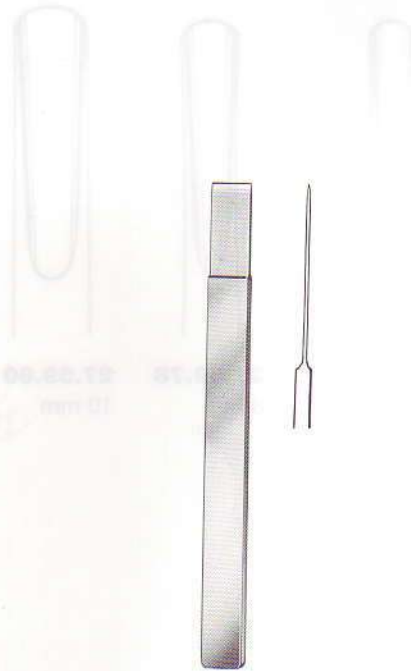

27.58.02	2 mm	27.58.10	10 mm
27.58.04	4 mm	27.58.12	12 mm
27.58.06	6 mm	27.58.15	15 mm
27.58.08	8 mm		

13 cm - 5¹/₈"

Hardt-Delima

27.58.90

Satz von 7 HARDT-DELIMA
Osteotomen, 2 - 15 mm breit,
13 cm lang, in Segeltuchetui

Set of 7 HARDT-DELIMA
Osteotomes, 2 thru 15 mm
wide, 13 cm - 5¹/₈"
in canvas roll

Juego de 7 osteótomos
HARDT-DELIMA, 2 a 15 mm
de ancho, 13 cm de largo,
en bolsa de lona

Série de 7 Ostéotomes de
HARDT-DELIMA, 2 à 15 mm de large,
13 cm de long, en housse de toile

Serie di 7 Osteotomi di
HARDT-DELIMA, largh. mm. 2 a 15,
lunghezza **cm. 13**
in cústodia di tela

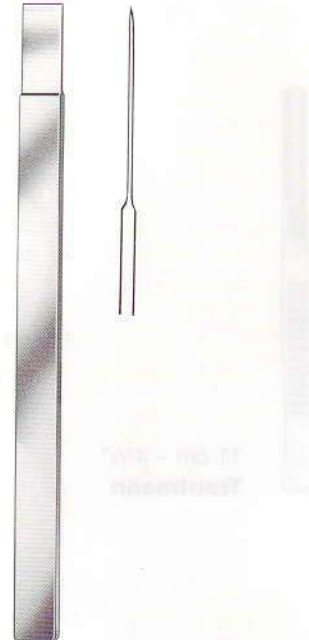

27.58.52	2 mm	27.58.60	10 mm
27.58.54	4 mm	27.58.62	12 mm
27.58.56	6 mm	27.58.65	15 mm
27.58.58	8 mm		

17 cm - 6³/₄"

Hardt-Delima

27.58.95

Satz von 7 HARDT-DELIMA
Osteotomen, 2 - 15 mm breit,
17 cm lang, in Segeltuchetui

Set of 7 HARDT-DELIMA
Osteotomes, 2 thru 15 mm
wide, 17 cm - 6³/₄"
in canvas roll

Juego de 7 osteótomos
HARDT-DELIMA, 2 a 15 mm
de ancho, 17 cm de largo,
en bolsa de lona

Série de 7 Ostéotomes de
HARDT-DELIMA, 2 à 15 mm de large,
17 cm de long, en housse de toile

Serie di 7 Osteotomi di
HARDT-DELIMA, largh. mm. 2 a 15,
lunghezza **cm. 17**
in cústodia di tela



11 cm - 4³/₈"
Trautmann



27.59.72
 2 mm



27.59.74
 4 mm



27.59.76
 6 mm



27.59.78
 8 mm



27.59.80
 10 mm



16 cm - 6¹/₄"
Sheehan



27.62.02
 2 mm



27.62.04
 4 mm



27.62.06
 6 mm



27.62.08
 8 mm



27.62.10
 10 mm



27.62.12
 12 mm



27.62.15
 15 mm



27.62.18
 18 mm

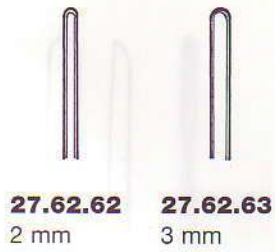

16 cm - 6 1/4"
Sheehan

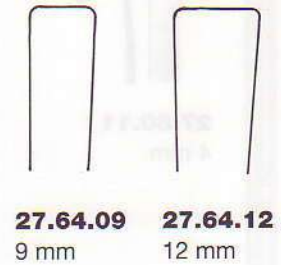
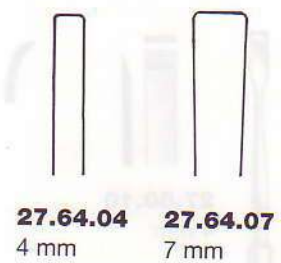
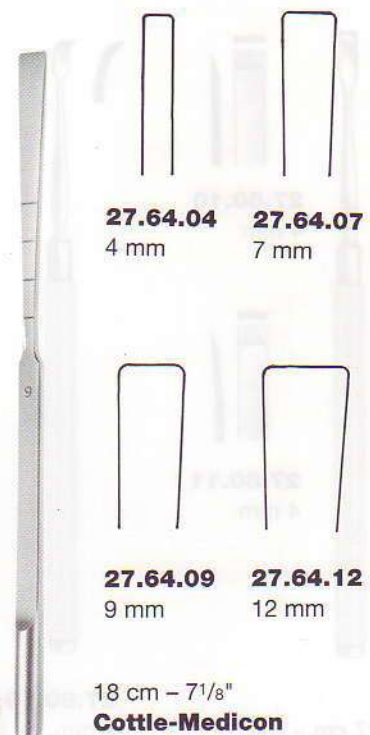

18 cm - 7 1/8"
Cottle-Medicon

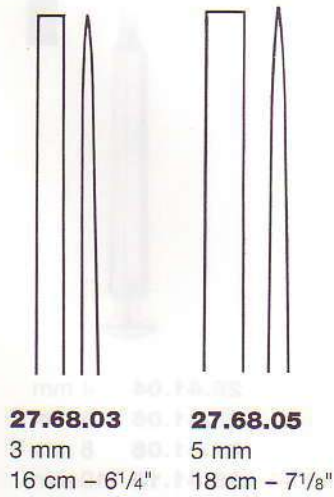

Moberg



27.68.14
4 mm
16 cm - 6 1/4"

Moberg



27.80.10
4 mm

27.80.11
4 mm

17 cm - 6³/₄"
Freer



27.80.19
4 mm, 17 cm - 6³/₄"
Freer

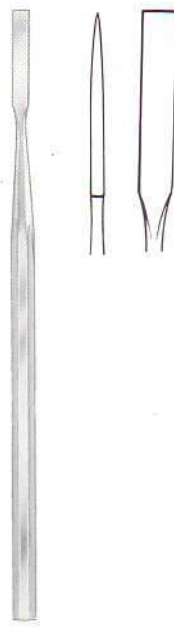

27.82.12
4 mm, 16 cm - 6¹/₄"
West



27.82.14
4 mm, 16 cm - 6¹/₄"
West

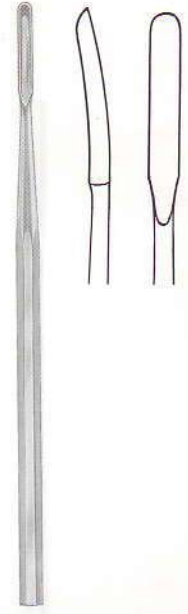

27.82.15
4 mm, 16 cm - 6¹/₄"
West

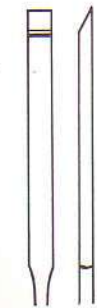

27.90.01
1

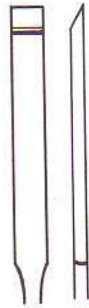

27.90.02
2



27.90.03
3

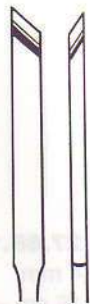

27.90.04
4

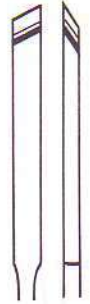

27.90.05
5

27.90.01 # 1
27.90.02 # 2
27.90.03 # 3
27.90.04 # 4
27.90.05 # 5
 15 cm - 6"
Buckley



28.41.04 4 mm
28.41.06 6 mm
28.41.08 8 mm
28.41.10 10 mm
28.41.12 12 mm
28.41.15 15 mm
 16 cm - 6¹/₄"
Stille



28.42.06 6 mm
28.42.08 8 mm
28.42.10 10 mm
28.42.12 12 mm
28.42.15 15 mm
 16 cm - 6¹/₄"
Stille



28.61.02 2 mm
28.61.04 4 mm
28.61.06 6 mm
28.61.08 8 mm
28.61.10 10 mm
28.61.12 12 mm
28.61.15 15 mm
28.61.20 20 mm
 18 cm - 7¹/₈"
Mini-Lexer



28.62.02 2 mm
28.62.04 4 mm
28.62.06 6 mm
28.62.08 8 mm
28.62.10 10 mm
28.62.12 12 mm
28.62.15 15 mm
28.62.20 20 mm
 18 cm - 7¹/₈"
Mini-Lexer

mit NOVOTEX-Kunststoffgriff
 (im Autoklaven sterilisierbar
 bis 143° C bei 3 bar)

with NOVOTEX plastic handles
 (sterilizable in autoclave
 up to 143° C at 3 bar)

con mango de materia
 plástica NOVOTEX,
 autoclavable hasta 143° C
 bajo presión de 3 atmósferas

avec manche en matière
 plastique NOVOTEX
 (stérilisable dans l'autoclave
 jusqu'à 143° C sous pression
 de 3 bars)

con manico di materiale plastico
 NOVOTEX (autoclavabile fino a
 143° C sotto pressione di 3 barie)



68.03.02
 2,5 mm



68.03.04
 4 mm



Osteotom
 Osteotome
 Osteótomo
 Osteótome
 Osteotomo

15 cm - 6"
Obwegeser



27.95.03
 Ø 3 mm



27.95.05
 Ø 5 mm



27.95.07
 Ø 7 mm



27.95.09
 Ø 9 mm



Stößel zur Blutstillung,
 auch als Stopfer für Knochen-
 material verwendbar, rund.

Hemostatic Chisels, round,
 also to be used as a bone filling
 instrument.

Punzón para hemostasia,
 sirviendo también de taponador
 para material de huesos, redondo.

Pilon pour hémostase, rond,
 servant aussi de fouloir
 pour matériel à os.

Pestello per emostasi, utilizzabile
 anche come Otturatore per materiale
 osseo, sezione rotonda.

16 cm - 6¹/₄"

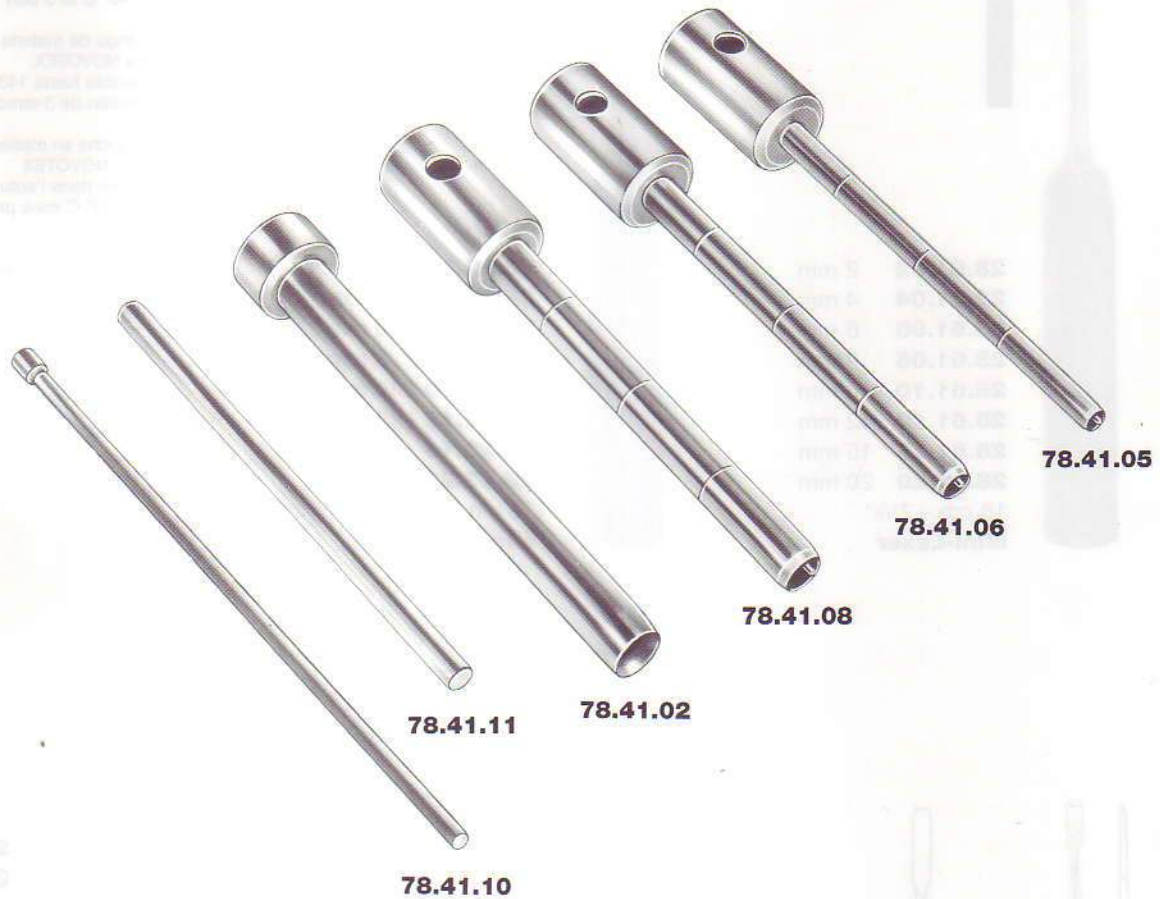

Zylinder-Osteotome zur Gewinnung von Knochentransplantaten (zur Entnahme von Spongiosa aus dem Darmbeinkamm für die Rekonstruktion von traumatischen Defekten der Hand)

Cylinder Osteotomes for Cancellous Bone Grafting (to obtain iliac crest bone grafts for the reconstruction of traumatic hand injuries)

Osteótomos cilíndricos para la extracción de injertos de hueso (para obtener injertos esponjosos de la cresta ilíaca para la reconstrucción de defectos de la mano)

Ostéotomes cylindriques pour le prélèvement de transplants osseux (pour le prélèvement de crêtes d'illion, pour la reconstruction de défauts traumatiques de la main)

Osteotomi cilindrici per l'estrazione dell' inserto osseo (per ottenere l'inserto spongioso della cresta iliaca per la ricostruzione del difetto della mano)

78.41.00

Shepard Zylinder-Osteotom, Satz komplett, bestehend aus: 1 Kortikalisstanze;
 1 Zylinder-Osteotom 5 mm; 1 Zylinder-Osteotom 6 mm; 1 Zylinder-Osteotom 8 mm;
 1 Ausstoßer; 1 Querstift.

Shepard Cylinder Osteotome, set complete, consisting of: 1 cortex cutter; 1 cylinder osteotome
 5 mm; 1 cylinder osteotome 6 mm; 1 cylinder osteotome 8 mm; 1 ram; 1 cross pin.

Shepard Osteótomo cilíndrico, juego completo, consiste de: 1 punzonadora cortical;
 1 osteótomo cilíndrico 5 mm; 1 osteótomo cilíndrico 6 mm; 1 osteótomo cilíndrico 8 mm,
 1 expulsor, 1 espiga transversal.

Shepard Ostéotome cylindrique, jeu complet, comprenant: 1 perforateur cortical, 1 ostéotome
 cylindrique 5 mm, 1 ostéotome cylindrique 6 mm, 1 ostéotome cylindrique 8 mm, 1 pousseur,
 1 embout croisé.

Shepard Osteotomo cilindrico, set completo, composto di: 1 punzone corticale; 1 Osteotomo
 cilindrico 5 mm; 1 Osteotomo cilindrico 6 mm; 1 Osteotomo cilindrico 8 mm; 1 espulsore;
 1 perno trasversale.

78.41.02

Shepard Kortikalisstanze
 Shepard Cortex Cutter
 Shepard punzonadora cortical
 Shepard perforateur cortical
 Shepard punzone corticale

78.41.05

Shepard Zylinder-Osteotom, 5 mm
 Shepard Cylinder Osteotome, 5 mm
 Shepard Osteótomo cilíndrico, 5 mm
 Shepard Ostéotome cylindrique, 5 mm
 Shepard Osteotomo, 5 mm

78.41.06

Shepard Zylinder-Osteotom, 6 mm
 Shepard Cylinder Osteotome, 6 mm
 Shepard Osteótomo cilíndrico, 6 mm
 Shepard ostéotome cylindrique, 6 mm
 Shepard Osteotomo cilindrico, 6 mm

78.41.08

Shepard Zylinder-Osteotom, 8 mm
 Shepard Cylinder Osteotome, 8 mm
 Shepard Osteótomo cilíndrico, 8 mm
 Shepard Ostéotome cylindrique, 8 mm
 Shepard Osteotomo cilindrico, 8 mm

78.41.10

Shepard Ausstoßer
 Shepard Ram
 Shepard expulsor
 Shepard pousseur
 Shepard espulsore

78.41.11

Shepard Querstift
 Shepard Cross Pin
 Shepard espiga transversal
 Shepard embout croisé
 Perno trasversale

weitere Informationen finden Sie in unserem Sonderprospekt
 further details can be found within our special folder
 más informaciones encuentran Uds. en nuestro folleto especial
 d'autres informations se trouvent dans notre prospectus spécial
 ulteriore informazione trovate nel nostro depliant speciale

MEDICONTAINER CONTAINER System

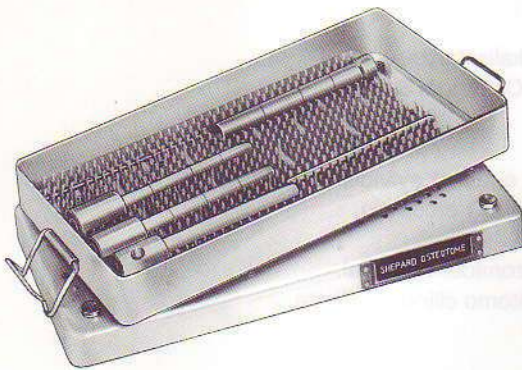

49.40.35

Sterilgut-Container aus Aluminium, silber eloxiert, inkl. Langzeit-Textilfilter, Deckel gelocht, Boden ungelocht, 300 x 135 x 47 mm

Aluminium sterilization container, silver anodized, incl. long-term textile filter, lid perforated, bottom non-perforated, 300 x 135 x 47 mm

Contenedor de aluminio para esterilización, anodizado en plata, con filtro de tejido, tapa perforada, fondo no perforado, 300 x 135 x 47mm

Container en aluminium pour la stérilisation, argent, anodisé, avec filtre textile longue durée, couvercle perforé, fond non-perforé, 300 x 135 x 47 mm

Contentori d'Alluminio, argentato ossidato, comp. con filtri tessili lunga durata, coperchio perforato, fondo non perforato, 300 x 135 x 47 mm



49.40.35

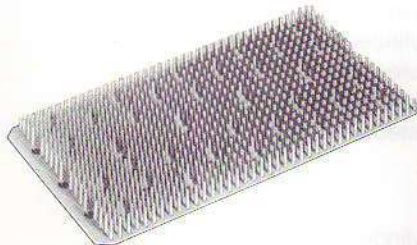

49.97.71

49.97.71

Silikon Noppenmatte zur Fixierung der Instrumente, 260 x 125 mm, 3 mm Noppenabstand

Silicon mat for fixation of instruments, 260 x 125 mm, 3 mm distance between naps

Estera de silicona para la fijación de los instrumentos, 260 x 125 mm, distancia entre los botones 3 mm

Tapis en silicone pour la fixation des instruments, 260 x 125 mm, distance entre les pointes 3 mm

Stoia a grumelli in silicone per il fissaggio degli strumenti, 260 x 125 x mm, distanza dei grumelli 3 mm

49.92.57

Kennzeichnungsschild für MEDICONTAINER, mit Gravur "SHEPARD OSTEOTOME", rot

Identification label for MEDICONTAINER, engraved "SHEPARD OSTEOTOME", red

Placa de identificación para MEDICONTAINER, grabada "SHEPARD OSTEOTOME", roja

Etiquette d'identification pour MEDICONTAINER, gravée "SHEPARD OSTEOTOME", rouge

Etichetta d'identificazione per MEDICONTAINER, con incisione "SHEPARD OSTEOTOME", rossa

SHEPARD OSTEOTOME

49.92.57

20.48.02
6 mm
17 cm - TW

20.48.04
6 mm
17 cm - TW

20.48.03
6 mm
17 cm - TW

20.48.05
7 mm
17 cm - TW

20.48.06
7 mm
18 cm - TW

20.48.07
7 mm
18 cm - TW



20.48.08
8 mm
18 cm - TW

20.48.09
8 mm
18 cm - TW

20.48.10

20.48.01
8 mm
20 cm - TW

20.48.02
7 mm
19 cm - TW

20.48.03
6 mm
18.5 cm - TW



Scharfe Löffel
Sharp Curettes
Cucharillas cortantes
Curettes tranchantes
Cucchiai taglienti



Schwedisches Modell
 Swedish pattern
 Modelo sueco
 Modèle suédois
 Modello svedese



29.48.02
 Ø 2 mm
 17 cm – 6³/₄"



29.48.03
 Ø 3 mm
 17 cm – 6³/₄"



29.48.04
 Ø 4 mm
 17 cm – 6³/₄"



29.48.05
 Ø 5 mm
 17,5 cm – 7"



29.48.06
 Ø 6 mm
 17,5 cm – 7"



29.48.07
 Ø 7 mm
 18 cm – 7¹/₈"



29.48.08
 Ø 8 mm
 18 cm – 7¹/₈"



29.49.02
 2 mm
 18 cm – 7¹/₈"



29.49.03
 3 mm
 18 cm – 7¹/₈"



29.49.04
 4 mm
 18,5 cm – 7¹/₄"



29.49.05
 5 mm
 18,5 cm – 7¹/₄"



29.49.06
 6 mm
 18,5 cm – 7¹/₄"



29.49.07
 7 mm
 19 cm – 7¹/₂"



29.49.08
 8 mm
 20 cm – 8"



Schwedisches Modell
 Swedish pattern
 Modelo sueco
 Modèle suédois
 Modello svedese



17 cm - 6³/₄"
Volkmann

29.51.24
0000

29.51.33
000

29.51.42
00

29.51.50
0

29.51.51
1

29.51.52
2

29.51.53
3

29.51.54
4

29.51.55
5

29.51.56
6



18 cm - 7¹/₈"
Spratt

29.63.33
000

29.63.42
00

29.63.50
0



29.63.51
1

29.63.52
2



20 cm - 8"
Lempert

29.67.06
6/0

29.67.15
5/0

29.67.24
4/0

29.67.33
3/0

29.67.42
00

29.67.50
0

29.67.51
1

29.67.52
2



29.80.10
00 - 0

29.80.11
0 - 1



29.80.12
1 - 2



14 cm - 5 1/2"
Martini



29.83.10
00 - 0

29.83.11
0 - 1



29.83.12
1 - 2



14 cm - 5 1/2"
Williger



29.83.50
 14 cm - 5 1/2"
Williger-Walter



29.83.62
 15 cm - 6"
Williger



29.87.11
 21 cm - 8 1/4"
Walter



30.52.00
19 cm - 7 1/2"
Lutz



30.52.14
14 cm - 5 1/2"
Friedmann



30.52.14
12 cm - 5"
H.D.S.



30.17.00
2 mm



30.17.00
2 mm

Knochenzangen
Knochenschere

Bone Forceps
Bone Scissors

Pinzas para huesos
Cizalla para huesos

Pinces à os
Cisaille à os

Pinze per ossa
Cesoia per ossa

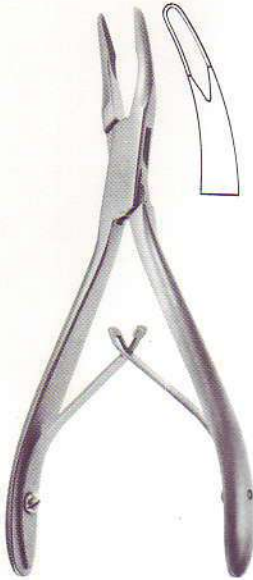

30.05.14
 14 cm - 5 1/2"
Friedmann

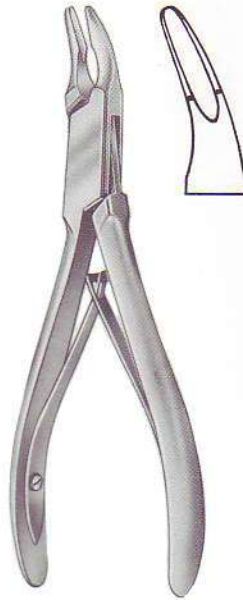

30.25.30
 30°, 16 cm - 6 1/4"
Blumenthal

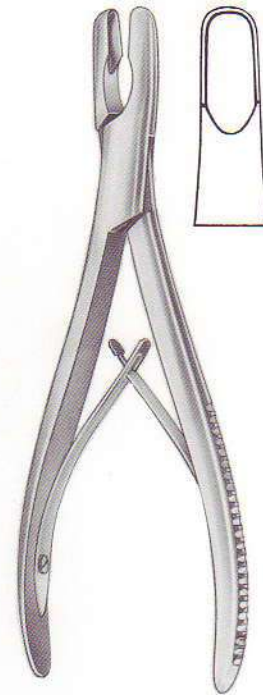

30.52.17
 18 cm - 7 1/8"
Luer



30.71.02
 17 cm - 6 3/4"
Beyer



30.71.02
 2 mm



30.71.03
 3 mm



30.75.14
 15 cm - 6"
S.G.H.

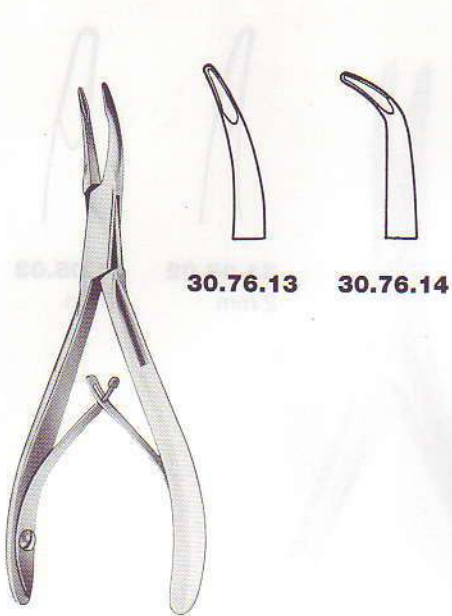

14 cm - 5 1/2"
Kleinert-Kutz

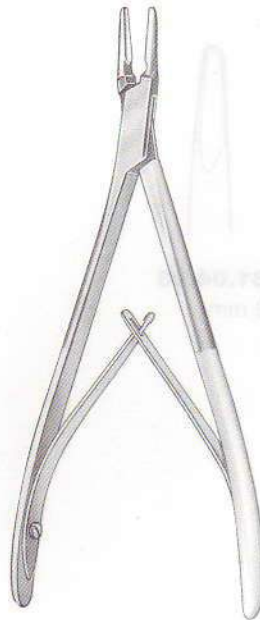

16,5 cm - 6 1/2"
Lempert



17 cm - 6 3/4"
Stellbrink



19 cm - 7 1/2"
Lempert



19 cm - 7 1/2"
Lempert

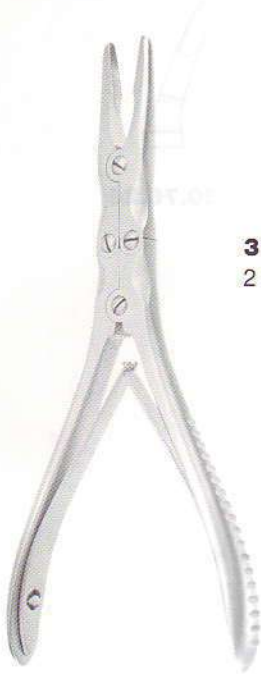

31.04.02
2 mm



31.04.03
3 mm

15 cm - 6"
Ruskin-Mini



31.05.02
2 mm



31.05.03
3 mm

15 cm - 6"
Ruskin-Mini

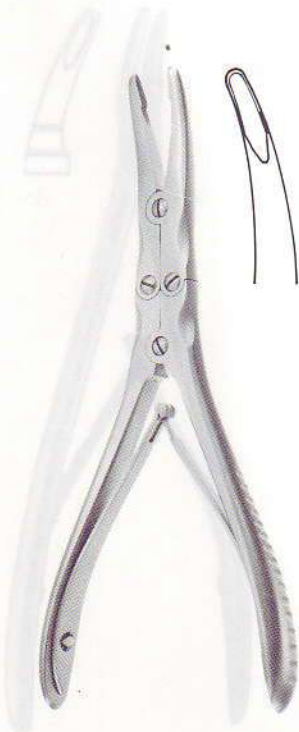

31.05.53
3 mm, 15 cm - 6"
Kleinert-Kutz



31.11.04
4 mm, 18 cm - 7 1/8"
Beyer



31.11.05
5 mm, 18 cm - 7 1/8"
Zaufal-Jansen

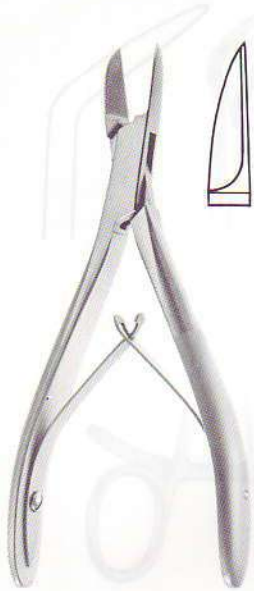

33.02.15
15 cm - 6"
Littauer-Liston

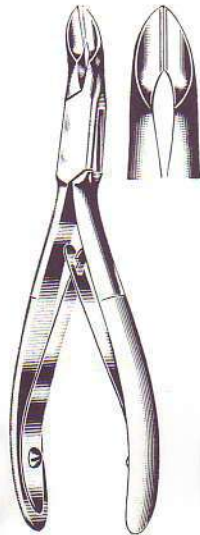

33.11.14
No. 5S, 14 cm - 5 1/2"
Niro



33.47.70
20 cm - 8"
Markwalder



33.57.18
19 cm - 7 1/2"
Ruskin-Liston



33.50.15
15 cm - 6"
Liston-mini



33.51.15
15 cm - 6"
Liston-mini

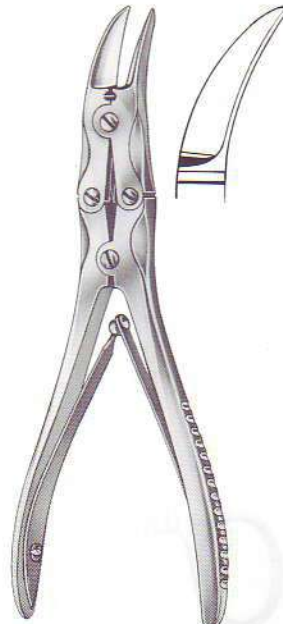

33.51.35
15 cm - 6"
Kleinert-Kutz



33.58.18



33.59.18



19 cm - 7 1/2"
McIndoe-Medicon

Repositionszangen
 Reposition Forceps
 Pinzas para la reducción
 Pinces de reposition
 Pinze per riposizione

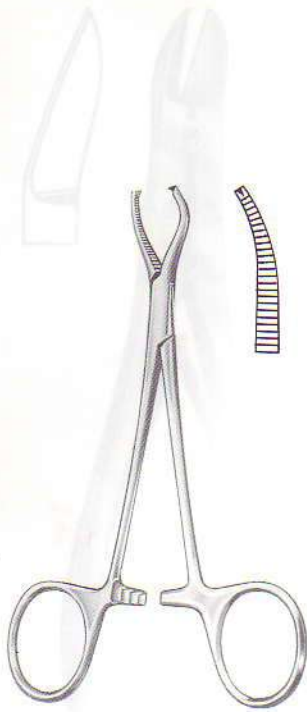

35.11.12
 12 cm - 4³/₈"
Mod. Lanz



35.11.13
 13 cm 5¹/₈"



35.11.14
 14,5 cm - 5³/₄"

Phalangenhaltezeuge
 Phalanx holding forceps
 Pinza de agarrar falanges
 Pince pour tenir les phalanges
 Pinza da presa per falangi

Repositionszangen
 Reposition Forceps
 Pinzas para la reducción
 Pinces de reposition
 Pinze per riposizione

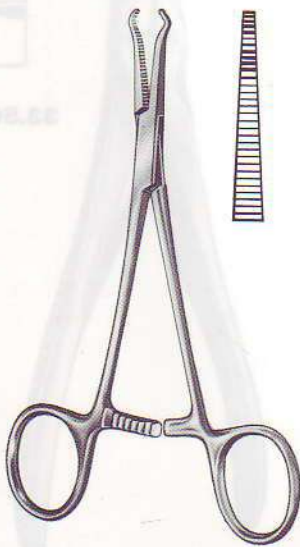

35.11.16
 14 cm - 5¹/₂"



35.14.14
 14 cm - 5¹/₂"



35.14.16
 16 cm - 6¹/₄"

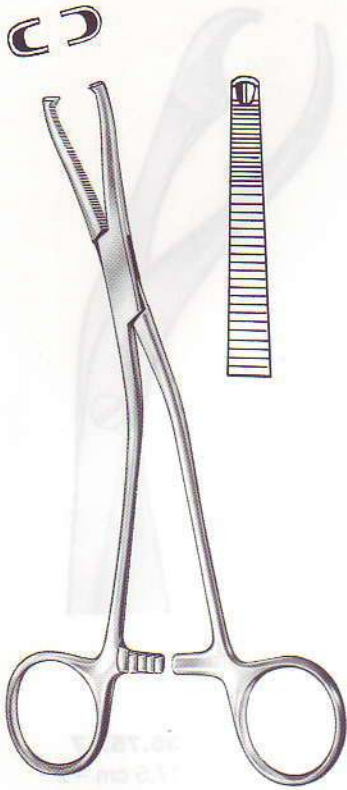

35.15.18
19 cm - 7½"
Dingman



35.15.19
19 cm - 7½"
Dingman

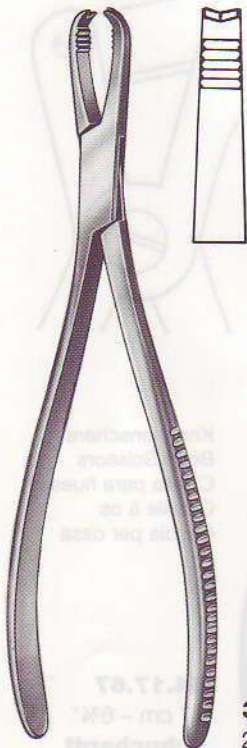

35.20.20
20 cm - 8"



Kern



35.35.14
14 cm - 5½"

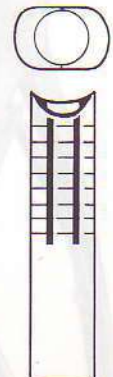

35.35.23
23 cm - 9"

Maulbreite 5 mm
 Jaw width 5 mm
 Boca 5 mm de ancho
 Largeur des mors 5 mm
 Larghezza dei morsi mm. 5



35.75.17
 17,5 cm - 7"
Verbrugge

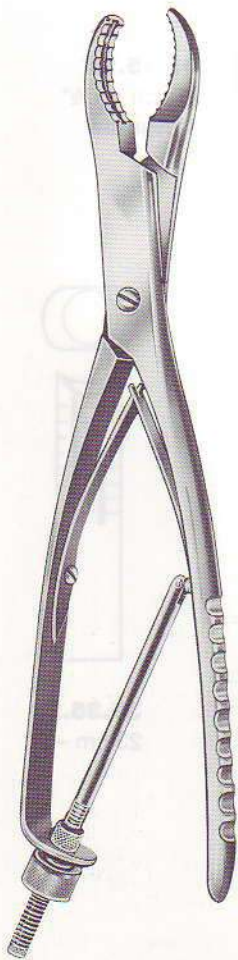

35.45.23
 23 cm - 9"
Ulrich



35.45.73
 23 cm - 9"
Ulrich



Knochenschere
 Bone Scissors
 Cizalla para huesos
 Cisaille à os
 Cesioia per ossa

54.17.67
 17 cm - 6¾"
Schuchardt

Haken-Marknägel, rund
Hook-end Intramedullary Nails, round shaped
Clavos medulares con gancho, redondos
Clous médullaires à crochets, ronds
Chiodi midollari ad uncino, rotondi

Ø 2,4 mm



aus nichtrostendem Implantatstahl nach DIN 17443 (ISO 5832/1)
 stainless steel for implants acc. to DIN 17443 (ISO 5832/1)
 fabricados de acero inoxidable especial para implantes según DIN 17443 (ISO 5832/1)
 faits en acier inoxydable spécial pour implants selon le standard établi DIN 17443 (ISO 5832/1)
 In acciaio inossidabile speciale per implantati secondo DIN 17443 (ISO 5832/1)

	Länge Length Largo Longueur Lunghezza
75.70.02	25 mm
75.70.03	30 mm
75.70.04	40 mm
75.70.54	45 mm
75.70.05	50 mm
75.70.06	60 mm
75.70.56	65 mm
75.70.07	70 mm
75.70.57	75 mm
75.70.08	80 mm
75.70.09	90 mm
75.70.59	95 mm
75.70.10	100 mm
75.70.12	120 mm
75.70.13	130 mm
75.70.14	140 mm
75.70.15	150 mm
75.70.16	160 mm
75.70.17	170 mm
75.70.19	190 mm
75.70.20	200 mm
75.70.21	210 mm
75.70.22	220 mm

Verpackungseinheit 1 Stück
 Packing unit 1 piece
 Caja con 1 pieza
 Boîtes de 1 pièce
 Unità di 1 pezzo



75.74.52
 17 cm lang – 6³/₄"

Ein- und Ausschlaginstrument für Haken-Marknägel, mit Querbohrung zum Biegen, für Marknägel von 2,4 mm Ø

Impactor and Extractor for hook-ended intramedullary nails, with cross-bore for bending, for intramedullary nails Ø 2.4 mm

Impactor para clavos medulares con gancho, con taladro transversal, para clavos medulares de 2,4 mm de Ø

Impacteur-extracteur pour clous médullaires à crochet, à forure transversale pour les plier, pour clous médullaires Ø 2,4 mm

Introduttore-Estrattore per chiodi midollari ad uncino, con foro trasversale per piegare i chiodi, per chiodi midollari Ø mm. 2,4

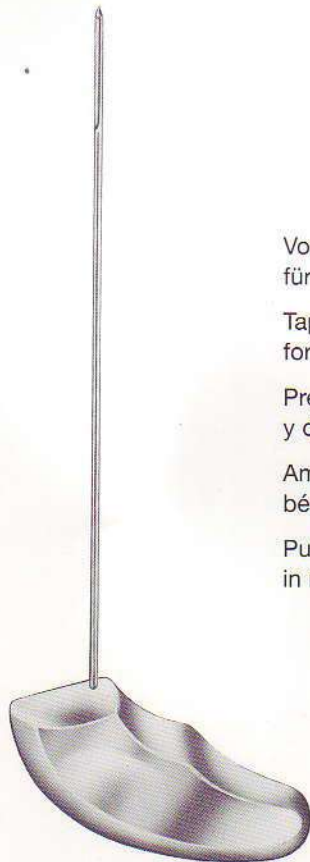

75.74.22
 18 cm lang – 7¹/₈"

Vorbohrer für Haken-Marknägel, mit Leichtmetall-Krückengriff für Marknägel von 2,4 mm Ø

Tap for hook-end intramedullary nails, with light-metal crutch handle for intramedullary nails Ø 2.4 mm

Preperforador para clavos medulares con gancho, con mango de metal ligero y de forma adaptada a la mano para clavos medulares de 2,4 mm de Ø

Amorçoir pour clous médullaires à crochet, avec manche en béquille de métal léger, pour clous médullaires Ø 2,4 mm

Punteruolo per chiodi midollari ad uncino, con impugnatura a gruccia in metallo leggero per chiodi midollari Ø mm. 2,4

Ein- und Ausbohrung für Haken-Mehrfächer mit Querbohrung
 zum Biegen, für Metall
 Ø 2,4 mm

Ein- und Ausbohrung für Haken-Mehrfächer mit
 Querbohrung, für Metall
 Ø 2,4 mm

Ein- und Ausbohrung für Haken-Mehrfächer mit
 Querbohrung, für Metall
 Ø 2,4 mm

Ein- und Ausbohrung für Haken-Mehrfächer mit
 Querbohrung, für Metall
 Ø 2,4 mm

Ein- und Ausbohrung für Haken-Mehrfächer mit
 Querbohrung, für Metall
 Ø 2,4 mm

18.T.4.32
 17 cm lang - 17"



Ein- und Ausbohrung für Haken-Mehrfächer
 zum Biegen, für Metall
 Ø 2,4 mm

Ein- und Ausbohrung für Haken-Mehrfächer mit
 Querbohrung, für Metall
 Ø 2,4 mm

Ein- und Ausbohrung für Haken-Mehrfächer mit
 Querbohrung, für Metall
 Ø 2,4 mm

Ein- und Ausbohrung für Haken-Mehrfächer mit
 Querbohrung, für Metall
 Ø 2,4 mm

Ein- und Ausbohrung für Haken-Mehrfächer mit
 Querbohrung, für Metall
 Ø 2,4 mm

18.T.4.32
 18 cm lang - 17"



aus hochveredeltem Instrumentstahl nach DIN 17443
stärkste Werkstoffqualität und in DIN 17443 200 200
Lichtmikroskopische Kontrolle nach DIN 17443
alle in einer Sterilisation für Instrumente
in einem sterilen Zustand für Instrumente

Knochendrähte
Bone Suturing Wires
Alambres para huesos
Fils d'acier à os
Filo d'acciaio per ossa

Knochendrähte

Bohrdrähte

Bone Suturing Wires

Wires

Alambres para huesos

Brocas filiformes

Fils d'acier à os

Forets filiformes

Filo d'acciaio per ossa

Punte filiforme

18.01.01	1.8 mm	18.01.01
18.01.02	2.0 mm	18.01.02
18.01.03	2.2 mm	18.01.03
18.01.04	2.4 mm	18.01.04
18.01.05	2.6 mm	18.01.05
18.01.06	2.8 mm	18.01.06
18.01.07	3.0 mm	18.01.07
18.01.08	3.2 mm	18.01.08
18.01.09	3.4 mm	18.01.09
18.01.10	3.6 mm	18.01.10
18.01.11	3.8 mm	18.01.11
18.01.12	4.0 mm	18.01.12
18.01.13	4.2 mm	18.01.13
18.01.14	4.4 mm	18.01.14
18.01.15	4.6 mm	18.01.15
18.01.16	4.8 mm	18.01.16
18.01.17	5.0 mm	18.01.17
18.01.18	5.2 mm	18.01.18
18.01.19	5.4 mm	18.01.19
18.01.20	5.6 mm	18.01.20
18.01.21	5.8 mm	18.01.21
18.01.22	6.0 mm	18.01.22
18.01.23	6.2 mm	18.01.23
18.01.24	6.4 mm	18.01.24
18.01.25	6.6 mm	18.01.25
18.01.26	6.8 mm	18.01.26
18.01.27	7.0 mm	18.01.27
18.01.28	7.2 mm	18.01.28
18.01.29	7.4 mm	18.01.29
18.01.30	7.6 mm	18.01.30
18.01.31	7.8 mm	18.01.31
18.01.32	8.0 mm	18.01.32
18.01.33	8.2 mm	18.01.33
18.01.34	8.4 mm	18.01.34
18.01.35	8.6 mm	18.01.35
18.01.36	8.8 mm	18.01.36
18.01.37	9.0 mm	18.01.37
18.01.38	9.2 mm	18.01.38
18.01.39	9.4 mm	18.01.39
18.01.40	9.6 mm	18.01.40
18.01.41	9.8 mm	18.01.41
18.01.42	10.0 mm	18.01.42
18.01.43	10.2 mm	18.01.43
18.01.44	10.4 mm	18.01.44
18.01.45	10.6 mm	18.01.45
18.01.46	10.8 mm	18.01.46
18.01.47	11.0 mm	18.01.47
18.01.48	11.2 mm	18.01.48
18.01.49	11.4 mm	18.01.49
18.01.50	11.6 mm	18.01.50
18.01.51	11.8 mm	18.01.51
18.01.52	12.0 mm	18.01.52
18.01.53	12.2 mm	18.01.53
18.01.54	12.4 mm	18.01.54
18.01.55	12.6 mm	18.01.55
18.01.56	12.8 mm	18.01.56
18.01.57	13.0 mm	18.01.57
18.01.58	13.2 mm	18.01.58
18.01.59	13.4 mm	18.01.59
18.01.60	13.6 mm	18.01.60
18.01.61	13.8 mm	18.01.61
18.01.62	14.0 mm	18.01.62
18.01.63	14.2 mm	18.01.63
18.01.64	14.4 mm	18.01.64
18.01.65	14.6 mm	18.01.65
18.01.66	14.8 mm	18.01.66
18.01.67	15.0 mm	18.01.67
18.01.68	15.2 mm	18.01.68
18.01.69	15.4 mm	18.01.69
18.01.70	15.6 mm	18.01.70
18.01.71	15.8 mm	18.01.71
18.01.72	16.0 mm	18.01.72
18.01.73	16.2 mm	18.01.73
18.01.74	16.4 mm	18.01.74
18.01.75	16.6 mm	18.01.75
18.01.76	16.8 mm	18.01.76
18.01.77	17.0 mm	18.01.77
18.01.78	17.2 mm	18.01.78
18.01.79	17.4 mm	18.01.79
18.01.80	17.6 mm	18.01.80
18.01.81	17.8 mm	18.01.81
18.01.82	18.0 mm	18.01.82
18.01.83	18.2 mm	18.01.83
18.01.84	18.4 mm	18.01.84
18.01.85	18.6 mm	18.01.85
18.01.86	18.8 mm	18.01.86
18.01.87	19.0 mm	18.01.87
18.01.88	19.2 mm	18.01.88
18.01.89	19.4 mm	18.01.89
18.01.90	19.6 mm	18.01.90
18.01.91	19.8 mm	18.01.91
18.01.92	20.0 mm	18.01.92
18.01.93	20.2 mm	18.01.93
18.01.94	20.4 mm	18.01.94
18.01.95	20.6 mm	18.01.95
18.01.96	20.8 mm	18.01.96
18.01.97	21.0 mm	18.01.97
18.01.98	21.2 mm	18.01.98
18.01.99	21.4 mm	18.01.99
18.01.100	21.6 mm	18.01.100

aus nichtrostendem Implantatstahl nach DIN 17443 (ISO 5832/1)
 stainless steel for implants acc. to DIN 17443 (ISO 5832/1)
 fabricados de acero inoxidable especial para implantes según DIN 17443 (ISO 5832/1)
 faits en acier inoxydable spécial pour implants selon le standard établi DIN 17443 (ISO 5832/1)
 In acciaio inossidabile speciale per implantati secondo DIN 17443 (ISO 5832/1)

Knochendraht, **weich**
 Bone Suturing Wire, **soft**
 Alambre para sutura ósea, **dulce**
 Fil d'acier à os, **souple**
 Filo d'acciaio per ossa, **dolce**



Rolle/10 m
 coil/10 meters
 rollo/10 m
 rouleau/10 m
 matassina/m. 10

76.01.02	Ø 0,25 mm	(31 G)
76.01.03	Ø 0,30 mm	(29 G)
76.01.04	Ø 0,40 mm	(27 G)
76.01.05	Ø 0,50 mm	(25 G)
76.01.06	Ø 0,60 mm	(23 G)
76.01.07	Ø 0,70 mm	(22 G)
76.01.08	Ø 0,80 mm	(21 G)
76.01.09	Ø 0,90 mm	(20 G)
76.01.10	Ø 1,0 mm	(19 G)
76.01.12	Ø 1,2 mm	(18 G)
76.01.15	Ø 1,5 mm	(17 G)

Kirschner Bohrdrähte mit Trokarspitze
Kirschner Wires with trocar-shaped tip
Kirschner Brocas filiformes con punta de trocar
Kirschner Forets filiformes à pointe trocar
Kirschner Perforatori filiformi con punta a tre quarti

aus nichtrostendem Implantatstahl nach DIN 17443 (ISO 5832/1)
stainless steel for implants acc. to DIN 17443 (ISO 5832/1)
fabricados de acero inoxidable especial para implantes según DIN 17443 (ISO 5832/1)
faits en acier inoxydable spécial pour implants selon le standard établi DIN 17443 (ISO 5832/1)
In acciaio inossidabile speciale per implantati secondo DIN 17443 (ISO 5832/1)



Kirschner

mit **flachem** Schaftende
wit **flat** shank end
con extremo **plano** del vastago
à bout de tige **plat**
con estremità **piatta**

	6 cm	10 cm	16 cm
Ø 0,8 mm	76.06.08	76.07.08	76.10.08
Ø 0,9 mm	76.06.09	76.07.09	76.10.09
Ø 1,0 mm	76.06.10	76.07.10	76.10.10
Ø 1,1 mm	76.06.11	76.07.11	76.10.11
Ø 1,2 mm	76.06.12	76.07.12	76.10.12
Ø 1,3 mm	76.06.13	76.07.13	76.10.13
Ø 1,4 mm	76.06.14	76.07.14	76.10.14
Ø 1,5 mm	76.06.15	76.07.15	76.10.15
Ø 1,6 mm	76.06.16	76.07.16	76.10.16
Ø 1,7 mm	76.06.17	76.07.17	76.10.17
Ø 1,8 mm	76.06.18	76.07.18	76.10.18
Ø 1,9 mm	76.06.19	76.07.19	76.10.19
Ø 2,0 mm	76.06.20	76.07.20	76.10.20
Ø 2,2 mm	76.06.22	76.07.22	76.10.22
Ø 2,5 mm	76.06.25	76.07.25	76.10.25

Mindestbestellmenge: 10 Stück (pro Modell und Abmessung).
Minimum quantity per order: 10 pieces of same style and diameter.
Los pedidos no deben ser inferiores a 10 piezas por modelo, largo y diámetro.
Quantité minimum à commander: 10 pièces par modèle, longueur et diamètre!
Quantità minima da ordinare: 10 pezzi per tipo, lunghezza e diametro.

Sonderlängen auf Wunsch lieferbar!
Additional sizes manufactured to order.
A petición, también se suministran en largos diferentes de los indicados!
Longueurs complémentaires, livrable sur demande!
A richiesta, anche fornibili in lunghezza speciali!

Kirschner Bohrdrähte mit Trokarspitze
 Kirschner Wires with trocar-shaped tip
 Kirschner Brocas filiformes con punta de trocar
 Kirschner Forets filiformes à pointe trocar
 Kirschner Perforatori filiformi con punta a trequarti

aus nichtrostendem Implantatstahl nach DIN 17443 (ISO 5832/1)
 stainless steel for implants acc. to DIN 17443 (ISO 5832/1)
 fabricados de acero inoxidable especial para implantes según DIN 17443 (ISO 5832/1)
 faits en acier inoxydable spécial pour implants selon le standard établi DIN 17443 (ISO 5832/1)
 In acciaio inossidabile speciale per implantati secondo DIN 17443 (ISO 5832/1)

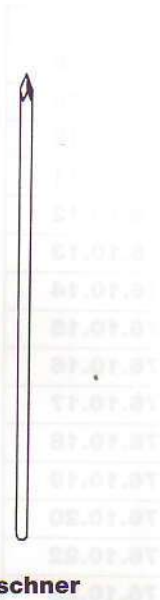

Kirschner

mit **rundem** Schaftende
 (nach DIN 58823)

with **round** end
 (acc. to. DIN 58823)

con extremo **redondo** del vástago
 (según DIN 58823)

à bout de tige **ron**d
 (selon DIN 58823)

con estremità **tonda**
 (secondo DIN 58823)

	6 cm	10 cm	16 cm
Ø 0,8 mm	76.06.58	76.07.58	76.10.58
Ø 0,9 mm	76.06.59	76.07.59	76.10.59
Ø 1,0 mm	76.06.60	76.07.60	76.10.60
Ø 1,1 mm	76.06.61	76.07.61	76.10.61
Ø 1,2 mm	76.06.62	76.07.62	76.10.62
Ø 1,3 mm	76.06.63	76.07.63	76.10.63
Ø 1,4 mm	76.06.64	76.07.64	76.10.64
Ø 1,5 mm	76.06.65	76.07.65	76.10.65
Ø 1,6 mm	76.06.66	76.07.66	76.10.66
Ø 1,7 mm	76.06.67	76.07.67	76.10.67
Ø 1,8 mm	76.06.68	76.07.68	76.10.68
Ø 1,9 mm	76.06.69	76.07.69	76.10.69
Ø 2,0 mm	76.06.70	76.07.70	76.10.70
Ø 2,2 mm	76.06.72	76.07.72	76.10.72
Ø 2,5 mm	76.06.75	76.07.75	76.10.75

Mindestbestellmenge: 10 Stück (pro Modell und Abmessung).

Minimum quantity per order: 10 pieces of same style and diameter.

Los pedidos no deben ser inferiores a 10 piezas por modelo, largo y diámetro.

Quantité minimum à commander: 10 pièces par modèle, longueur et diamètre!

Quantità minima da ordinare: 10 pezzi per tipo, lunghezza e diametro.

Sonderlängen auf Wunsch lieferbar!

Additional sizes manufactured to order.

A petición, también se suministran en largos diferentes de los indicados!

Longueurs complémentaires, livrable sur demande!

A richiesta, anche fornibili in lunghezze speciali!

Kirschner Bohrdrähte mit Trokarspitze
 Kirschner Wires with trocar-shaped tip
 Kirschner Brocas filiformes con punta de trocar
 Kirschner Forets filiformes à pointe trocart
 Kirschner Perforatori filiformi con punta a trequarti

aus nichtrostendem Implantatstahl nach DIN 17443 (ISO 5832/1)
 stainless steel for implants acc. to DIN 17443 (ISO 5832/1)
 fabricados de acero inoxidable especial para implantes según DIN 17443 (ISO 5832/1)
 faits en acier inoxydable spécial pour implants selon le standard établi DIN 17443 (ISO 5832/1)
 In acciaio inossidabile speciale per implantati secondo DIN 17443 (ISO 5832/1)



Kirschner

beidseitig mit
Trokarspitze
 with trocar points
on **both ends**
 con punta de trocar
de **ambos extremos**
 à pointe trocart
aux **deux bouts**
 con punta a trequarti
da **entrambi i lati**

	6 cm	10 cm	16 cm
Ø 0,8 mm	76.06.78	76.07.78	76.10.78
Ø 0,9 mm	76.06.79	76.07.79	76.10.79
Ø 1,0 mm	76.06.80	76.07.80	76.10.80
Ø 1,1 mm	76.06.81	76.07.81	76.10.81
Ø 1,2 mm	76.06.82	76.07.82	76.10.82
Ø 1,3 mm	76.06.83	76.07.83	76.10.83
Ø 1,4 mm	76.06.84	76.07.84	76.10.84
Ø 1,5 mm	76.06.85	76.07.85	76.10.85
Ø 1,6 mm	76.06.86	76.07.86	76.10.86
Ø 1,7 mm	76.06.87	76.07.87	76.10.87
Ø 1,8 mm	76.06.88	76.07.88	76.10.88
Ø 1,9 mm	76.06.89	76.07.89	76.10.89
Ø 2,0 mm	76.06.90	76.07.90	76.10.90
Ø 2,2 mm	76.06.92	76.07.92	76.10.92
Ø 2,5 mm	76.06.95	76.07.95	76.10.95

Mindestbestellmenge: 10 Stück (pro Modell und Abmessung).
 Minimum quantity per order: 10 pieces of same style and diameter.
 Los pedidos no deben ser inferiores a 10 piezas por modelo, largo y diámetro.
 Quantité minimum à commander: 10 pièces par modèle, longueur et diamètre!
 Quantità minima da ordinare: 10 pezzi per tipo, lunghezza e diametro.

Sonderlängen auf Wunsch lieferbar!
 Additional sizes manufactured to order.
 A petición, también se suministran en largos diferentes de los indicados!
 Longueurs complémentaires, livrable sur demande!
 A richiesta, anche fornibili in lunghezze speciali!

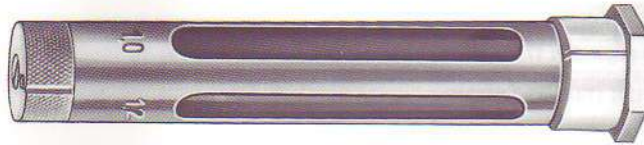

76.10.00

Bohrdrahtspender für Bohrdrähte mit **10 cm** Länge und 1,0 – 1,2 – 1,4 und 1,6 mm Durchmesser.

Dispenser for wires of **10 cm** length and 1,0 – 1,2 – 1,4 and 1,6 mm diameter.

Dispensador para alambres de **10 cm** longitud y 1,0 – 1,2 – 1,4 y 1,6 mm diámetro.

Distributeur de forets filiformes d'une longueur de **10 cm** et d'un diamètre de 1,0 – 1,2 – 1,4 et 1,6 mm.

Distributore di fili per fili con **cm 10** di lunghezza e 1,0 – 1,2 – 1,4 e 1,6 mm di diametro.



76.16.00

Bohrdrahtspender für Bohrdrähte mit **16 cm** Länge und 1,0 – 1,2 – 1,4 und 1,6 mm Durchmesser.

Dispenser for wires of **16 cm** length and 1,0 – 1,2 – 1,4 and 1,6 mm diameter.

Dispensador para alambres de **16 cm** longitud y 1,0 – 1,2 – 1,4 y 1,6 mm diámetro.

Distributeur de forets filiformes d'une longueur de **16 cm** et d'un diamètre de 1,0 – 1,2 – 1,4 et 1,6 mm.

Distributore di fili per fili con **cm 16** di lunghezza e 1,0 – 1,2 – 1,4 e 1,6 mm di diametro.

76.16.01

Bohrdrahtspender für Bohrdrähte mit **16 cm** Länge und 1,8 – 2,0 – 2,2 und 2,5 mm Durchmesser.

Dispenser for wires of **16 cm** length and 1,8 – 2,0 – 2,2 and 2,5 mm diameter.

Dispensador para alambres de **16 cm** longitud y 1,8 – 2,0 – 2,2 y 2,5 mm diámetro.

Distributeur de forets filiformes d'une longueur de **16 cm** et d'un diamètre de 1,8 – 2,0 – 2,2 et 2,5 mm.

Distributore di fili per fili con **cm 16** di lunghezza e 1,8 – 2,0 – 2,2 e 2,5 mm di diametro.

Draht- und Blechschere, gezahnt
 Wire Cutting Scissors, serrated
 Tijeras para cortar hilo de acero, dentadas
 Ciseaux coupe-fil, dentés
 Forcici dentellate per tagliare fili, d'acciaio



14.00.01
14.5 cm



14.00.01
15 cm - 4 3/8"
Universal "HM"

Drahtinstrumente
Wire Instruments
Instrumentos para alambre
Instruments pour fils métalliques
Strumenti per fili d'acciaio

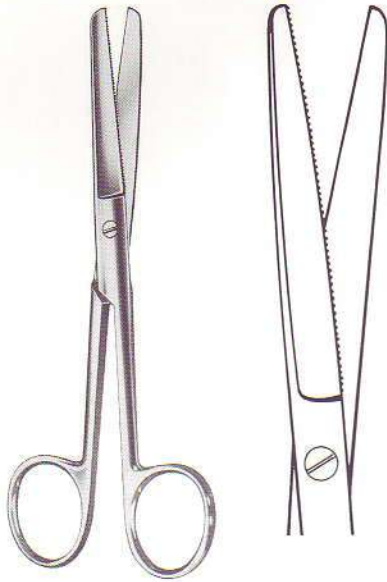

14.09.84
 14,5 cm - 5³/₄"

Drahtschere, gezahnt
 Wire Cutting Scissors, serrated
 Tijera para cortar hilo de acero, dentada
 Ciseaux coupe-fil, dentelé
 Forbice dentellata per tagliare fili d'acciaio



14.20.09
 10 cm - 4"
Schuknecht



14.23.12
 12 cm - 4³/₄"
Universal



14.23.62
 12 cm - 4³/₄"
Universal "HM"



gezahnt
serrated
dentada
dentelé
dentellata

14.28.68
16 cm – 6 1/4"
"HM"



gezahnt
serrated
dentada
dentelé
dentellata

14.29.68
16 cm – 6 1/4"
"HM"

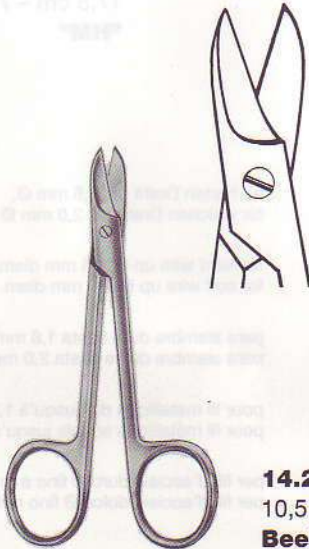

14.26.10
10,5 cm – 4 1/8"
Beebee

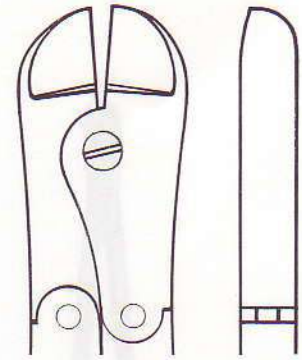
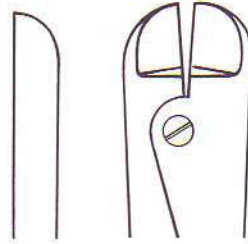
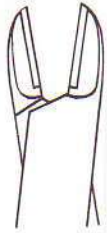

14.30.11
 12 cm – 4³/₄"
 "HM"

für harten Draht bis 0,6 mm Ø,
 für weichen Draht bis 1,0 mm Ø

for hard wire up to 0.6 mm diam.
 for soft wire up to 1.0 mm diam.

para alambre duro hasta 0,6 mm de Ø
 para alambre dulce hasta 1,0 mm de Ø

pour fil métallique dur jusqu'à 0,6 mm de Ø
 pour fil métallique souple jusqu'à 1,0 mm de Ø

per fili d'acciaio duro Ø fino a mm 0,6
 per fili d'acciaio dolce Ø fino mm 1,0



14.30.13
 13 cm – 5¹/₈"
 "HM"

für harten Draht bis 1,2 mm Ø,
 für weichen Draht bis 1,6 mm Ø

for hard wire up to 1.2 mm diam.
 for soft wire up to 1.6 mm diam.

para alambre duro hasta 1,2 mm de Ø
 para alambre dulce hasta 1,6 mm de Ø

pour fil métallique dur jusqu'à 1,2 mm de Ø
 pour fil métallique souple jusqu'à 1,6 mm de Ø

per fili d'acciaio duro Ø fino a mm 1,2
 per fili d'acciaio dolce Ø fino mm 1,6



14.30.17
 17,5 cm – 7"
 "HM"

für harten Draht bis 1,6 mm Ø,
 für weichen Draht bis 2,0 mm Ø

for hard wire up to 1.6 mm diam.
 for soft wire up to 2.0 mm diam.

para alambre duro hasta 1,6 mm de Ø
 para alambre dulce hasta 2,0 mm de Ø

pour fil métallique dur jusqu'à 1,6 mm de Ø
 pour fil métallique souple jusqu'à 2,0 mm de Ø

per fili d'acciaio duro Ø fino a mm 1,6
 per fili d'acciaio dolce Ø fino mm 2,0

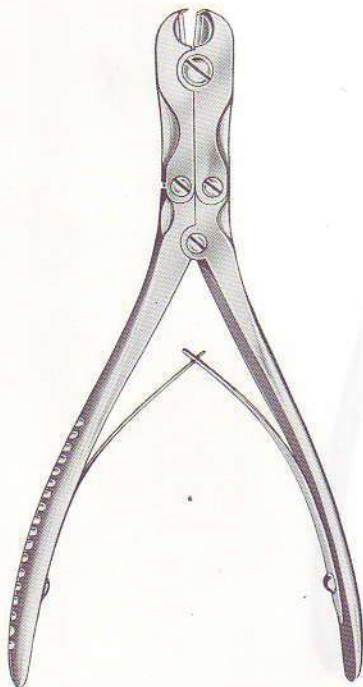
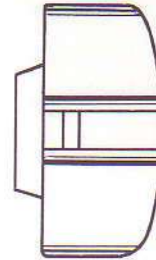
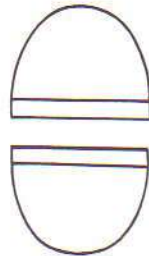
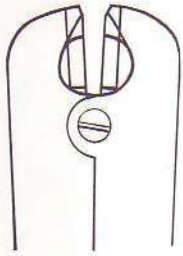

14.30.28
18 cm - 7 1/8"

14.30.65
15 cm - 6"

14.30.76
16 cm - 6 1/4"

für harten Draht bis 1,6 mm Ø,
für weichen Draht bis 2,0 mm Ø

for hard wire up to 1.6 mm diam.
for soft wire up to 2.0 mm diam.

para alambre duro hasta 1,6 mm de Ø
para alambre dulce hasta 2,0 mm de Ø

pour fil métallique dur jusqu'à 1,6 mm de Ø
pour fil métallique souple jusqu'à 2,0 mm de Ø

per fili d'acciaio duro Ø fino a mm 1,6
per fili d'acciaio dolce Ø fino mm 2,0

für harten Draht bis 1,5 mm Ø,
für weichen Draht bis 2,0 mm Ø

for hard wire up to 1.5 mm diam.
for soft wire up to 2.0 mm diam.

para alambre duro hasta 1,5 mm de Ø
para alambre dulce hasta 2,0 mm de Ø

pour fil métallique dur jusqu'à 1,5 mm de Ø
pour fil métallique souple jusqu'à 2,0 mm de Ø

per fili d'acciaio duro Ø fino a mm 1,5
per fili d'acciaio dolce Ø fino mm 2,0

für harten Draht bis 1,5 mm Ø,
für weichen Draht bis 2,0 mm Ø

for hard wire up to 1.5 mm diam.
for soft wire up to 2.0 mm diam.

para alambre duro hasta 1,5 mm de Ø
para alambre dulce hasta 2,0 mm de Ø

pour fil métallique dur jusqu'à 1,5 mm de Ø
pour fil métallique souple jusqu'à 2,0 mm de Ø

per fili d'acciaio duro Ø fino a mm 1,5
per fili d'acciaio dolce Ø fino mm 2,0



68.04.81
 11,5 cm – 4 1/2"
Obwegeser

für weichen Draht bis 0,6 mm Ø
 for soft wire up to 0.6 mm diam.
 para alambre dulce hasta 0,6 mm de Ø
 pour fil métallique souple jusqu'à 0,6 mm de Ø
 per fili d'acciaio dolce Ø fino mm 0,6



68.04.82
 16,5 cm – 6 1/2"
Obwegeser

für weichen Draht bis 0,6 mm Ø
 for soft wire up to 0.6 mm diam.
 para alambre dulce hasta 0,6 mm de Ø
 pour fil métallique souple jusqu'à 0,6 mm de Ø
 per fili d'acciaio dolce Ø fino mm 0,6



14.40.15
15 cm - 6"
Niro

14.40.65
15 cm - 6"
Niro "HM"

14.44.17
17 cm - 6³/₄"
Medicon

14.44.67
17 cm - 6³/₄"
Medicon "HM"

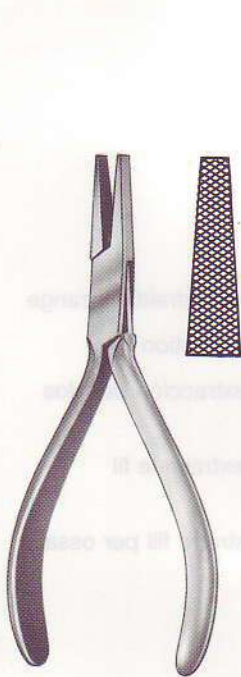

14.46.14
14 cm - 5¹/₂"



14.48.05
5 mm

14.48.07
7 mm

18 cm - 7¹/₈"



68.04.90
13 cm - 5¹/₈"
Obwegeser



68.04.85
 13 cm - 5 1/8"
Obwegeser

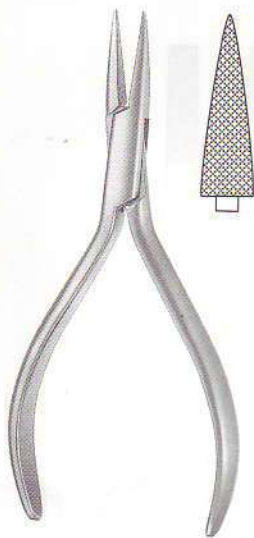

68.04.86
 14 cm - 5 1/2"
Obwegeser



68.04.87
 15 cm - 6"
Obwegeser



68.04.88
 20 cm - 8"
Obwegeser



78.03.08
 16 cm - 6 1/4"
Hackstock

Knochendraht-Extraktionszange
Bone Wire Extraction Plier
Pinza para extracción de hilos de acero
Pince pour extraire le fil d'acier à os
Pinza per estrarre fili per ossa



Finger-Extensionsbügel
Finger Extension Bow
Estrizo de extensión para dedos
Etrier à extension pour doigts
Staffa per le dita



78.03.30 25 x 50 mm

78.03.31 35 x 60 mm

Framer



78.03.35 6 cm - 2³/₈"

78.03.36 7,5 cm - 3"

Schwarz

Finger-Extensionsbügel
Finger Extension Bow
Estríbo de extensión para dedos
Etrier à extension pour doigts
Staffa per le dita



05.02.00

Winkelstück für Kirchner Bohrer, Instrumentenlänge 110 mm, mit Intro-Kupplung nach DIN 137 für Querschnitt von 0,5 - 1,6 mm Durchmesser

Hand piece, angled for Kirchner, with intro coupling as per DIN 137

Pièce de main angulaire pour broches de Kirchner

Bohrapparate

Bohrer

Perforators

Burrs

Perforadores

Brocas

Perforateurs

Fraises

Das passende Mikromotor-Antriebsystem finden Sie in unserem Sonderpreisblatt servotronik.
 Per le compatibili micromotori presso noi o presso servotronik.
 Para encontrar el micromotor adecuado para este sistema en nuestro folleto especial servotronik.
 Pour trouver le micromoteur compatible dans notre prospectus spécial servotronik.
 Il corrispondente sistema micromotor è illustrato nel nostro prospecto servotronik.

Apparecchiatura per perforatori

Perforatori

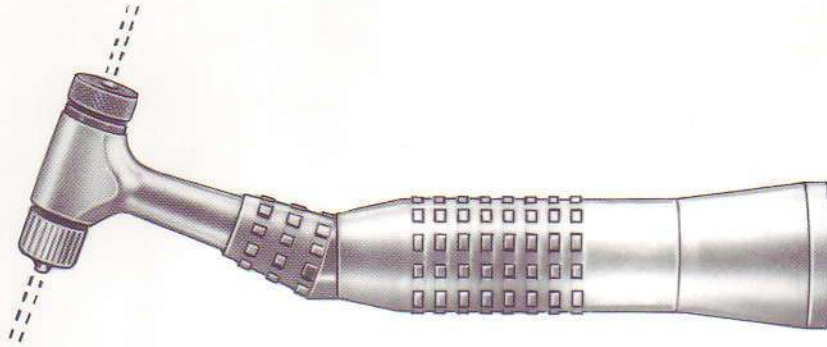

68.24.40

Winkel-Handstück für Kirschner Bohrdrähte, Untersetzung 1:16, max. 15000 U/min.
Gesamtlänge 110 mm, mit Intra-Kupplung nach DIN 13940/ISO-DIS 3964,
für Drähte von 0,5 – 1,6 mm Durchmesser.

Hand piece, angled, for Kirschner wires, reduction 1:16, max. 15000 rpm, total length 110 mm,
with Intra coupling as per DIN 13940/ISO-DIS 3954, for wires from 0,5 – 1,6 mm diameter.

Pieza de mano acodada para brocas de Kirschner, reducción 1:16, max. 15000 r.p.m.,
longitud 110 mm, con acoplamiento Intra según DIN 13940/ISO-DIS 3954,
para brocas de 0,5 – 1,6 mm diámetro.

Pièce à main angulaire pour broches de Kirschner, réduction 1:16, max. 15000 t.p.m.,
longueur totale 110 mm, avec Intra-accouplement selon DIN 13940/ISO-DIS 3964,
pour broches d'un diamètre de 0,5 à 1,6 mm.

Manipolo angolato per perforatori filiformi di Kirschner, riduzione 1:16,
max. 15000 giri/min., lunghezza totale 110 mm, con Intra-Aggiunto secondo
DIN 13940/ISO-DIS 3964, per fili con diametro 0,5 – 1,6 mm.

Das passende Mikromotor-Antriebssystem finden Sie in unserem Sonderprospekt servotronic.
For the corresponding micromotor system please see our brochure servotronic.
El sistema de accionamiento micromotor está ilustrado en nuestro folleto especial servotronic.
Vous trouverez le micromoteur convenable dans notre prospectus spécial servotronic.
Il corrispondente sistema micromotore é illustrato sul nostro prospetto servotronic.

für Bohrer bis 4 mm Ø, für Kirschner Bohrdrähte bis 3 mm Ø
 for twist drills up to 4 mm Ø, for Kirschner wires up to 3 mm Ø
 para brocas hasta 4 mm Ø, para brocas de Kirschner hasta 3 mm Ø
 pour fraises jusqu'à 4 mm Ø, pour broches de Kirschner jusqu'à 3 mm Ø
 per perforatori fino Ø mm 4, per perforatori filiformi di Kirschner fino Ø mm 3

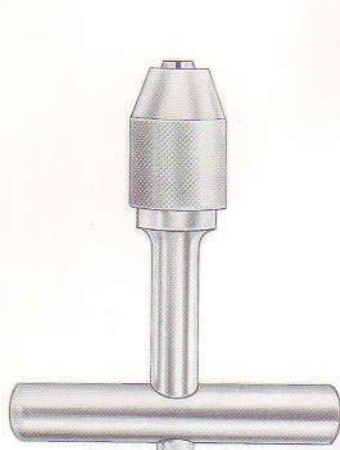

78.03.05

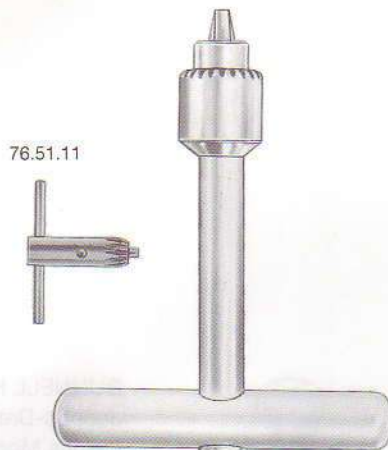

78.03.07

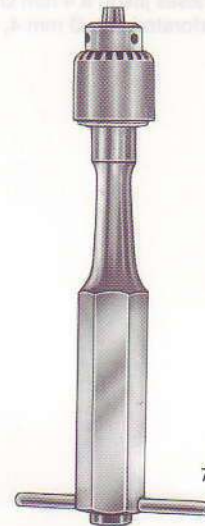

76.51.11

76.51.11
 Schlüssel allein
 Wrench only
 llave, suelta
 clé, seule
 chiave, sola

Handbohrgriff mit
 Dreibackenspannfutter, manuell
 ohne Schlüssel, mit Längskanal für
 Kirschner- Bohrdrähte

Drill Handle with three-jaw chuck,
 locked by rotatable sleeve, with axial
 channel for passing Kirschner wires

Mango para perforadores en "T" y
 porta-brocas trimandibular con
 conducto longitudinal para brocas
 de Kirschner, de ajuste manual sin
 necesitar llave

Manche à perforeur, avec mandrin à
 trois mâchoires, serrage manuel
 sans clé, avec conduit longitu-
 dinal pour forets filiformes de
 Kirschner

Manico per perforatori, con
 mandrino a tre ganasce senza
 chiave, cannulato per il passaggio di
 fili Kirschner

Handbohrgriff mit
 Jacobs-Dreibackenspannfutter und
 Schlüssel, Längskanal für Kirschner-
 Bohrdrähte

Drill Handle with Jacobs chuck,
 wrench-operated, with axial channel
 for Kirschner wires

Mango para perforadores en "T" y
 porta-brocas de 3 mordazas de
 Jacobs, con llave, con conducto
 longitudinal para brocas de
 Kirschner

Trépan à perforeur, avec mandrin à
 trois mâchoires de Jacobs avec clé,
 avec conduit longitudinal pour forets
 filiformes de Kirschner

Manico per perforatori, con
 mandrino Jacobs a tre ganasce con
 chiave, cannulato per il passaggio di
 fili Kirschner

Handbohrgriff mit
 Jacobs-Dreibackenspannfutter und
 Schlüssel, Längskanal für Kirschner-
 Bohrdrähte

Drill Handle with Jacobs chuck,
 wrench-operated, with axial channel
 for Kirschner wires

Mango para perforadores en "T" y
 porta-brocas de 3 mordazas de
 Jacobs, con llave, con conducto
 longitudinal para brocas de
 Kirschner

Trépan à perforeur, avec mandrin à
 trois mâchoires de Jacobs avec clé,
 avec conduit longitudinal pour forets
 filiformes de Kirschner

Manico per perforatori, con
 mandrino Jacobs a tre ganasce con
 chiave, cannulato per il passaggio di
 fili Kirschner

für Bohrer bis 4 mm Ø, für Kirschner Bohrdrähte bis 3 mm Ø
 for twist drills up to 4 mm Ø, for Kirschner wires up to 3 mm Ø
 para brocas hasta 4 mm Ø, para brocas de Kirschner hasta 3 mm Ø
 pour fraises jusqu'à 4 mm Ø, pour broches de Kirschner jusqu'à 3 mm Ø
 per perforatori fino Ø mm 4, per perforatori filiformi di Kirschner fino Ø mm 3

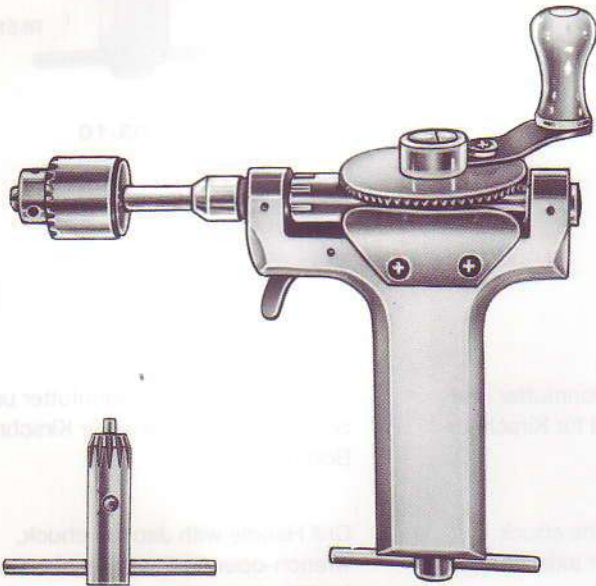

76.51.11

Schlüssel allein
 Wrench only
 llave, suelta
 clé, seule
 chiave, sola

76.51.10
Bunnell

BUNNELL Handbohrapparat mit
 Jacobs-Dreibackenspannfutter und Schlüssel,
 kleines Modell, mit längsdurchbohrtem Kanal
 für Kirschner-Bohrdrähte

BUNNELL Hand Drill with Jacobs chuck,
 wrench-locking, small pattern, with axial
 channel for passing Kirschner wires

BUNNELL Perforador de mano, con
 porta-brocas de tres mordazas e Jacobs, con
 llave, modelo pequeño – con conducto
 longitudinal para pasar brocas filiformes de
 Kirschner

BUNNELL Perforateur à main, avec mandrin
 Jacobs à trois mâchoires avec clé, petit
 modèle, avec conduit longitudinal pour forets
 filiformes de Kirschner

BUNNELL Trapano a mano con mandrino
 Jacobs a tre ganasce con chiave, modello
 piccolo, cannulato per il passaggio di
 perforatori filiformi di Kirschner

für Bohrer bis 7 mm Ø, für Kirschner Bohrdrähte bis 4 mm Ø
 for twist drills up to 7 mm Ø, for Kirschner wires up to 4 mm Ø
 para brocas hasta 7 mm Ø, para brocas de Kirschner hasta 4 mm Ø
 pour fraises jusqu'à 7 mm Ø, pour broches de Kirschner jusqu'à 4 mm Ø
 per perforatori fino Ø mm 7, per perforatori filiformi di Kirschner fino Ø mm 4



76.51.21

Schlüssel allein
 Wrench only
 llave, suelta
 clé, seule
 chiave, sola

**76.51.20
Ralk**

RALK Handbohrapparat mit
 Jacobs-Dreibackenspannfutter und Schlüssel,
 mit längsdurchbohrtem Kanal für
 Kirschner-Bohrdrähte

RALK Hand Drill with Jacobs chuck,
 wrench-locking, with axial channel for passing
 Kirschner wires

RALK Perforador de mano con porta-brocas
 de tres mordazas de Jacobs, con llave, con
 conducto longitudinal para pasar brocas
 filiformes de Kirschner

RALK Perforateur à main avec mandrin Jacobs
 à trois mâchoires avec clé, avec conduit
 longitudinal pour forets filiformes de Kirschner

RALK Trapano a mano con mandrino Jacobs a
 tre ganasce con chiave, cannolato per il
 passaggio di perforatori filiformi di Kirschner

für Bohrer bis 4 mm Ø, für Kirschner Bohrdrähte bis 4 mm Ø
for twist drills up to 4 mm Ø, for Kirschner wires up to 4 mm Ø
para brocas hasta 4 mm Ø, para brocas de Kirschner hasta 4 mm Ø
pour fraises jusqu'à 4 mm Ø, pour broches de Kirschner jusqu'à 4 mm Ø
per perforatori fino Ø mm 4, per perforatori filiformi di Kirschner fino Ø mm 4



76.51.61

Schlüssel allein
Wrench only
llave, suelta
clé, seule
chiave, sola

76.51.60
Smedberg

SMEDBERG Handbohrapparat mit
Jacobs-Dreibackenspannfutter und Schlüssel,
mit längsdurchbohrtem Kanal für
Kirschner-Bohrdrähte

SMEDBERG Hand Drill with Jacobs chuck,
wrench-locking, with axial channel for passing
Kirschner wires

SMEDBERG Perforador de mano con
porta-brocas de tres mordazas de Jacobs, con
llave, con conducto longitudinal para pasar
brocas filiformes de Kirschner

SMEDBERG Perforateur à main avec mandrin
Jacobs à trois mâchoires avec clé, avec
conduit longitudinal pour forets filiformes de
Kirschner

SMEDBERG Trapano a mano con mandrino
Jacobs a tre ganasce, con chiave, cannulato
per il passaggio di perforatori filiformi di
Kirschner

Handbohrer
Hand Drills
Perforadores de mano
Trépans à main
Perforatori a mano

Spiralbohrer für Handbohrgriffe
und Handbohrapparate
Twist drills for drill handles
and hand drills

Brocas espirales para mangos de perforadores
de mano y aparatos perforadores de mano

Fraises en spirale pour manches à perforateur
et pour perforateurs à main

Perforatore elicoidale per manici per perforatori
e apparecchiatura per perforatori

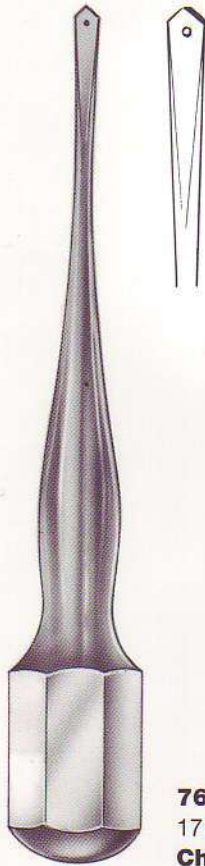

76.55.17
17 cm – 6³/₄"
Championniere



76.69.15	1,5 mm Ø,	7 cm
76.69.20	2,0 mm Ø,	8,5 cm
76.69.25	2,5 mm Ø,	9,5 cm
76.69.30	3,0 mm Ø,	10 cm
76.69.32	3,2 mm Ø,	10 cm
76.69.35	3,5 mm Ø,	11 cm
76.69.40	4,0 mm Ø,	12 cm
76.69.45	4,5 mm Ø,	13 cm
76.69.50	5,0 mm Ø,	13 cm
76.69.60	6,0 mm Ø,	14 cm

Handbohrer
 Hand Drills
 Perforators de mano
 Trépano à man
 Perforator a mano

Spindelbohrer für Holz, Metall
 und Handbohrer
 Twist drills for wood
 and hand drills
 Brocas escalonados
 de mano y para
 perforar en
 el punto
 Perforator
 escalonado

Perforator de mano
 Trépano à man
 Perforator a mano



- 10.00.00 6,0 mm Ø, 14 cm
- 10.00.00 6,0 mm Ø, 12 cm
- 10.00.00 4,5 mm Ø, 12 cm
- 10.00.00 4,0 mm Ø, 12 cm
- 10.00.00 3,5 mm Ø, 11 cm
- 10.00.00 2,5 mm Ø, 10 cm
- 10.00.00 2,0 mm Ø, 10 cm
- 10.00.00 2,5 mm Ø, 8,5 cm
- 10.00.00 2,0 mm Ø, 8,5 cm
- 10.00.10 1,5 mm Ø, 7 cm

10.00.10
 17 cm - 6W
 Champollivier

Reibahn
mit ALU-Handgriff
Reamer square
with aluminum handle
Reamer square
with aluminum handle
Reamer square
with aluminum handle
Reamer square
with aluminum handle
Reamer square
with aluminum handle

Reibahn
Reamer square
Escariador cuadrado
Alésoir à main carré
Alesatori quadrato

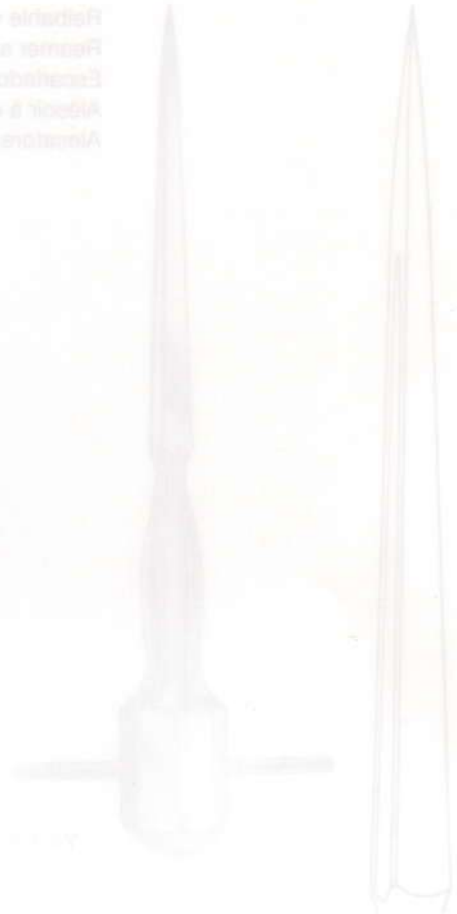

Reibahlen
Knochenpfrieme

Reamers
Bone Piercers

Escariadores
Punzones

Alésoirs à main
Alènes à os

Alesatori
Puntaruoli

Reibahn
mit NOVOTEX-Handgriff
Reamer square
with NOVOTEX handle
Reamer square
with NOVOTEX handle
Reamer square
with NOVOTEX handle
Reamer square
with NOVOTEX handle
Reamer square
with NOVOTEX handle
Reamer square
with NOVOTEX handle

Reibahn
Reamer square
Escariador cuadrado
Alésoir à main carré
Alesatori quadrato



Reibahn
17 cm - 8 1/2"
Med. Lanz

Reibahn
18 cm - 8 1/2"
Med. Lanz

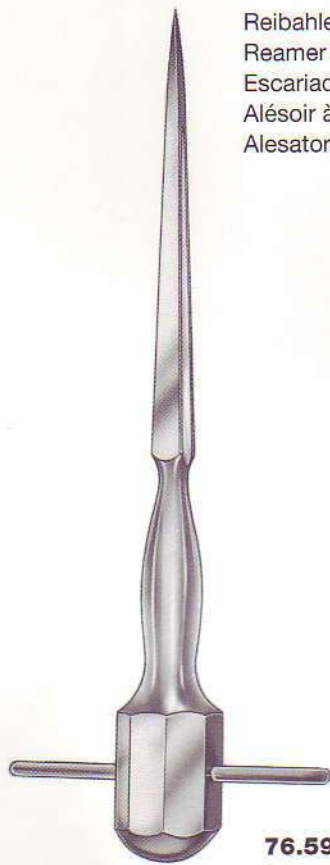
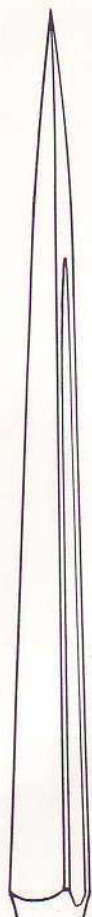

Reibahle vierkant
 Reamer square
 Escariador cuadrado
 Alésoir à quatre pans
 Alesatore quadrangolare

76.59.21
 21 cm – 8¹/₄"
Perthes

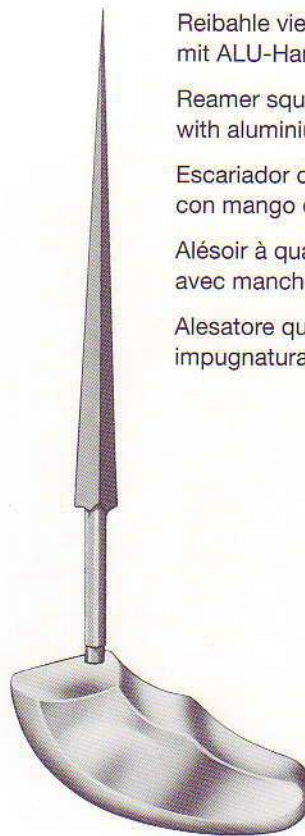

Reibahle vierkant,
 mit ALU-Handgriff
 Reamer square,
 with aluminium handle
 Escariador cuadrado,
 con mango de aluminio
 Alésoir à quatre pans,
 avec manche en aluminium
 Alesatore quadrangolare,
 impugnatura in alluminio

76.59.22
 22 cm – 8³/₄"
Perthes



Knochenpfrieme (Reibahlen)
 Bone Piercers (Reamers)
 Punzones (Escariadores)
 Alènes à os (Alésoirs à main)
 Puntaruoli (Alesatori)

78.03.01
 16 cm – 6¹/₄"



mit NOVOTEX-Kunststoffgriff
 (im Autoklaven sterilisierbar
 bis 143° C bei 3 bar)
 with NOVOTEX plastic handle
 (autoclavable up to 143° C at 3 bar)
 con mango en materia
 plástica NOVOTEX,
 autoclavable hasta 143° C
 bajo presión de 3 atmósferas
 avec manche en matière
 plastique NOVOTEX
 (stérilisable dans l'autoclave
 jusqu'à 143° C sous pression
 de 3 bars)
 con manico di materiale plastico
 NOVOTEX (autoclavabile fino a
 143° C sotto pressione di 3 bar)

78.03.02
 17 cm – 6³/₄"
Mod. Lanz



10.00.01
7 mm
15 cm - 6"



10.00.02
7 mm
14 cm - 5 1/2"



11.00.01
12 mm
16 cm - 6 1/4"



11.00.02
12 mm
16 cm - 6 1/4"



11.00.03
12 mm
16 cm - 6 1/4"

Knochenhebel
Bone Levers
Elevadores óseos
Leviers à os
Elevatori per ossa



78.35.03
 3 mm
 14 cm - 5½"



78.35.05
 5 mm
 15 cm - 6"



78.35.07
 7 mm
 15 cm - 6"



78.35.55
 5,5 mm
 16,5 - 6½"

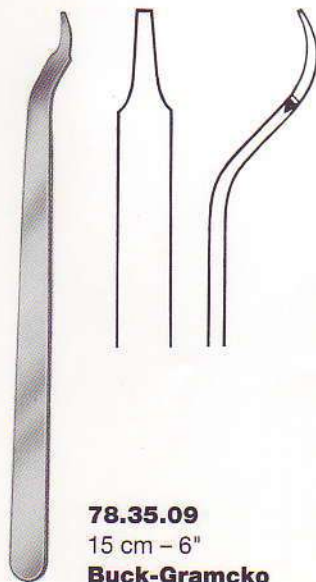

78.35.09
 15 cm - 6"
Buck-Gramcko

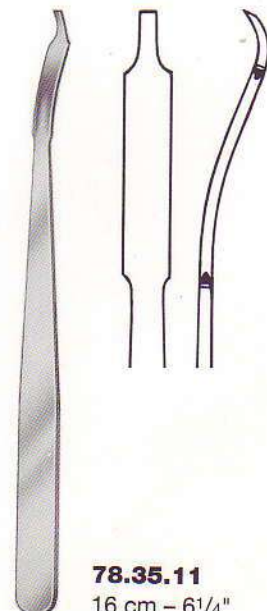

78.35.11
 16 cm - 6¼"



00.04.10



00.04.11

00.04.00

00.04.01-01 3004, integrat
12.000 €

00.04.02 3004 integrat
12.000 €

00.04.03 3004, can tub de succie
12.000 €

00.04.04 3004, canule
12.000 €

00.04.05 3004, tub de livrare
12.000 €

Oscilante Mic
Säge mit Gel
Oscillationsäge
Micro oscillating saw
Impuls mit Gel
Micro serra oscilante mic
Integrat, can tub de succie
Integrat, canule
Canule
Micro serra oscilante mic
Integrat, can tub de succie
Integrat, canule
Canule
Micro serra oscilante mic
Integrat, can tub de succie
Integrat, canule
Canule

00.04.10
00.04.11
00.04.12
00.04.13
00.04.14
00.04.15

00.04.16
00.04.17
00.04.18
00.04.19
00.04.20
00.04.21

Sägen
Saws
Sierras
Scies
Seghe

Micro oscillating saw according to Säge
Micro serra oscilante "Modelo Säge"
Micro serra oscilante "Modelo Säge"

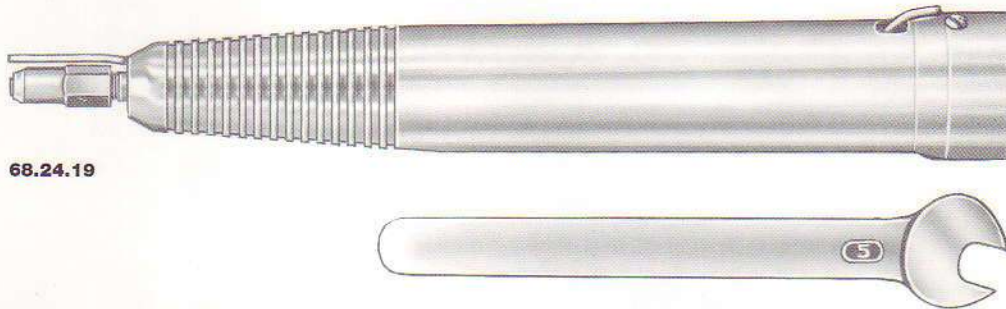

68.24.19

68.24.20

68.24.00

Oszillierende Mikro-Säge ohne Sägeblätter, mit INTRA Kupplung nach DIN 13940/ISO-DIS 3964, integriertes Spühhrohr, mit Gabelschlüssel, empfohlene maximale Motordrehzahl: 15.000 U/min \pm 15.000 Oszillationen/Minute.

Micro oscillating saw without saw blades, with INTRA coupling acc. to DIN 13940/ISO-DIS 3964, integrated irrigation tube, with fork wrench, recommended maximum speed: 15.000 rpm \pm 15.000 oscillations/minute.

Micro sierra oscilante sin hojas, con acoplamiento INTRA según DIN 13940/ISO-DIS 3964, con tubo de succión integrado, con llave horquilla, número de revoluciones del motor recomendado: 15.000 r.p.m. \pm 15.000 oscilaciones por minuto.

Scie micro oscillante, sans lames de scie, avec accouplement INTRA selon DIN 13940/ISO-DIS 3964, canule de lavage intégrée, avec clef, nombre de tours maximum recommandé: 15.000 t.p.m. \pm 15.000 oscillations par minute.

Micro sega oscillante senza lame, con INTRA-Aggiunto secondo DIN 13940/ISO-DIS 3964, tubo di lavaggio integrato, con chiave a forcina, considerato regime max. di rotazione del motore: 15.000 al minuto \pm 15.000 oscillazioni/min.

68.24.19

Ersatz-Überwurfmutter für Spannfutter
Spare fixation nut for chuck
Tuerca de racor de repuesto para mandril de sujeción
Ecrou fileté pour mandrin de serrage
Dado a cappello di ricambio per mandrino

68.24.20

Gabelschlüssel allein
Fork wrench only
Llave horquilla suelta
Clef seule
Chiave a forcina sola

Säge
Saws

- Das passende Mikromotor-Antriebssystem finden Sie in unserem Sonderprospekt servotronic.
- For the corresponding micromotor system please see our brochure servotronic.
- El sistema de accionamiento micromotor está ilustrado en nuestro folleto especial servotronic.
- Vous trouverez le micromoteur convenable dans notre prospectus spécial servotronic.
- Il corrispondente sistema micromotore é illustrato sul nostro prospetto servotronic.

Die geringe Blattstärke der Sägeblätter ermöglicht sehr feine Schnitte.
 As the blades are extremely thin very delicate cuts can be achieved.
 El grosor mínimo de las hojas hace posible cortes muy finos.
 Les lames de scie sont très minces ce qui permet des coupes très fines.
 Il sottile spessore delle lame da sega rende possibile tagli molto delicati.

Sägeblätter mit **kurzem** Schaft, Nutzlänge: 11 mm
 Saw blades with **short** shank, working length: 11 mm
 Hojas de sierra con vástago **corto**, largo útil: 11 mm
 Lame de scie avec tige **courte**, longueur utile: 11 mm
 Lame per sega con asta **corta**, lungh. utile: 11 mm

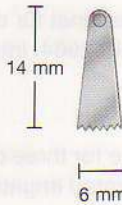
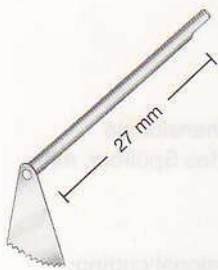

68.24.24
0,3 mm



68.24.25
0,3 mm



68.24.26
0,3 mm

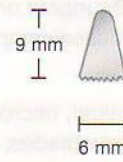

68.24.30
0,15 mm

Blattstärke →
 Thickness of blade
 Grosor de la hoja
 Epaisseur de la lame
 Spessore della lama

Sägeblätter mit **langem** Schaft, Nutzlänge: 26 mm
 Saw blades with **long** shank, working length: 26 mm
 Hojas de sierra con vástago **largo**, largo útil: 26 mm
 Lame de scie avec tige **longue**, longueur utile: 26 mm
 Lame per sega con asta **lunga**, lungh. utile: 26 mm

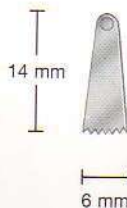
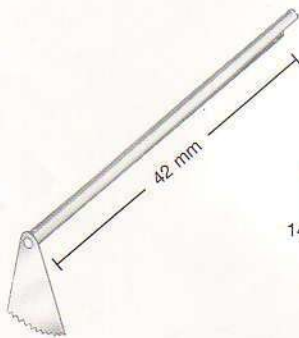

68.24.27
0,3 mm



68.24.28
0,3 mm

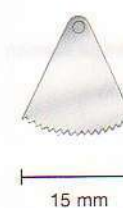

68.24.29
0,3 mm

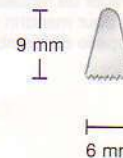

68.24.31
0,15 mm

Blattstärke →
 Thickness of blade
 Grosor de la hoja
 Epaisseur de la lame
 Spessore della lama

US Pat.5.201.749
 US Pat.5.201.749
 Patente americano 5.201.749
 Brevet US 5.201.749
 US brevetto 5.201.749

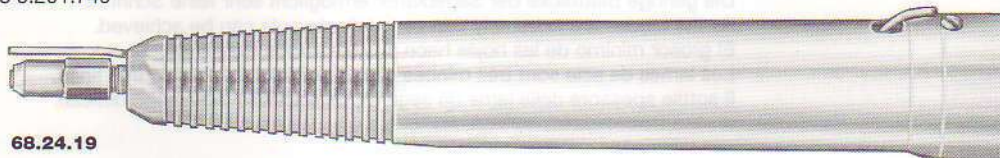

68.24.19

DBP angemeldet
 DBP pending
 solicitado al patente DBP
 DBP en cours
 OBP iscritto



68.24.20

68.24.05

Osseoskalpell, Mikro-Säge mit axial/sagittalem Schnitt, Pendelhub, besonders geeignet für dreidimensionale Schnittführungen; ohne Sägeblätter, mit INTRA Kupplung nach DIN 13940/ISO-DIS 3964, integriertes Spülrohr, mit Gabelschlüssel, empfohlene maximale Motordrehzahl: 20.000 U/min.

Osseoscalpel, micro saw with axial/sagittal cut, oscillating hub, especially suitable for three dimensional cutting; without saw blades, with INTRA coupling acc. to DIN 13940/ISO-DIS 3964, integrated irrigation tube, with fork wrench, recommended maximum speed: 20.000 rpm.

Microsierra Osseoscalpel con corte axial/sagital, elevación de péndulo, especialmente apropiada para cortes tridimensionales; sin hojas, con INTRA-acoplamiento según DIN 13940/ISO-DIS 3964, tubo de irrigación integrado, con llave, revolución max. de motor recomendada: 20.000 r.p.m.

Osséoscalpel, scie micro à coupe axiale/sagittale, par voie excentrique, particulièrement conçu pour des coupes tridimensionnelles; sans lames de scie, avec INTRA-accouplement selon DIN 13940/ISO-DIS 3964, conduite de lavage intégrée, avec clef fourchue, nombre de tours max. recommandé: 20.000 t.p.m.

Scalpello Osseo, micro sega con taglio assiale/saggitale, corsa del pendolo, adatto specialmente per guida taglio tredimensionale; senza lame, con INTRA-Aggiunto secondo DIN 13940/ISO-DIS 3964, tubo di lavaggio integrato, con chiave per dado, considerato regime max. di rotazione del motore: 20.000 giri/min.

68.24.19

Ersatz-Überwurfmutter für Spannfutter
 Spare fixation nut for chuck
 Tuerca de racor de repuesto para mandril de sujeción
 Ecrou fileté pour mandrin de serrage
 Dado a cappello di ricambio per mandrino

68.24.20

Gabelschlüssel allein
 Fork wrench only
 Llave horquilla suelta
 Clef seule
 Chiave a forcina sola

Das passende Mikromotor-Antriebssystem finden Sie in unserem Sonderprospekt servotronic.
 For the corresponding micromotor system please see our brochure servotronic.
 El sistema de accionamiento micromotor está ilustrado en nuestro folleto especial servotronic.
 Vous trouverez le micromoteur convenable dans notre prospectus spécial servotronic.
 Il corrispondente sistema micromotore é illustrato sul nostro prospetto servotronic.



Sägeblätter
 Saw blades
 Hojas de sierra
 Lame de scie
 Lame per sega

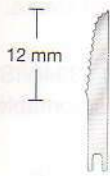

68.24.35

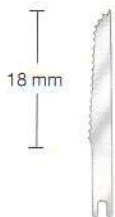

68.24.36



68.24.37

Verpackungseinheit 12 Stück
 Packing unit 12 pieces
 Cajas con 12 piezas
 Boîtes de 12 pièces
 Unità di 12 pezzi

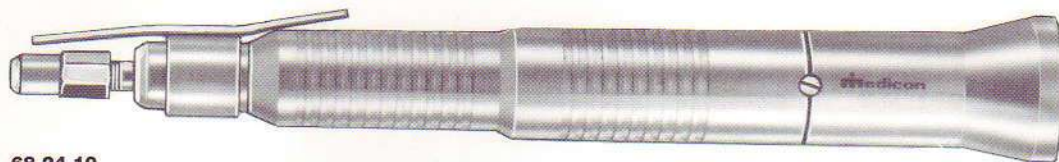

68.24.19

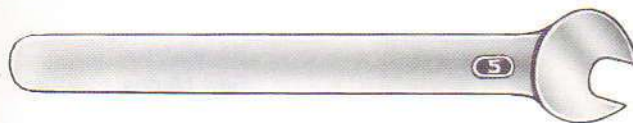

68.24.20

68.24.10

Mikro-Stichsäge, mit Gabelschlüssel, ohne Sägeblätter, mit INTRA-Kupplung nach DIN 13940/ISO-DIS 3964; Schwingungen je Sekunde: 160 (bei 20.000 U/min); Hub: 2 mm; hygienisch: zur Pflege und Reinigung zerlegbar.

Micro compass saw, with fork wrench, without saw blades, with INTRA coupling acc. to DIN 13940/ISO-DIS 3964; oscillations per second: 160 (at 20.000 rpm); height of stroke: 2 mm; hygienic: easily dismantable for maintenance and cleaning.

Micro sierra, con llave horquilla, sin hojas, con acoplamiento INTRA según DIN 13940/ISO-DIS 3964; vibraciones por segundo: 160 (a 20.000 r.p.m.); elevación: 2 mm; higiénico: desmontable para mantenimiento y limpieza.

Scie micro à guichet, avec clef, sans lames de scie, avec INTRA-Accouplement selon DIN 13940/ISO-DIS 3964; vibrations par seconde: 160 (à 20.000 t.p.m.); course: 2 mm; hygiénique: peut être démontée pour l'entretien et le nettoyage.

Micro sega, con chiave a forcina, senza lame, con INTRA-Aggiunto secondo DIN 13940/ISO-DIS 3964; vibrazioni per secondo: 160 (a 20.000 g/min); corsa: 2 mm; igienico: smontabile per pulitura e lavaggio.

68.24.19

Ersatz-Überwurfmutter für Spannutter
Spare fixation nut for chuck
Tuerca de racor de repuesto para mandril de sujeción
Ecrou fileté pour mandrin de serrage
Dado a cappello di ricambio per mandrino

68.24.20

Gabelschlüssel allein
Fork wrench only
Llave horquilla suelta
Clef seule
Chiave a forcina sola

Das passende Mikromotor-Antriebssystem finden Sie in unserem Sonderprospekt servotronic.
For the corresponding micromotor system please see our brochure servotronic.
El sistema de accionamiento micromotor está ilustrado en nuestro folleto especial servotronic.
Vous trouverez le micromoteur convenable dans notre prospectus spécial servotronic.
Il corrispondente sistema micromotore é illustrato sul nostro prospetto servotronic.

Sägeblätter
Saw blades
Hojas de sierra
Lame de scie
Lame per sega

11 mm



68.24.12

14 mm



68.24.13

18 mm



68.24.14

22 mm



68.24.15

26 mm



68.24.16



68.24.22

Ersatz-Sprührohraufsatz
Spare irrigation tube for micro compass saw
Tubo de recambio para irrigación para micro sierra
Canule de lavage de rechange pour scie micro à guichet
Cannula per lavaggio di ricambio per micro sega



68.24.21

Hartmetall Raspelaufsatz
TC rasp for micro compass saw
Escofina de tungsteno para micro sierra
Râpe en tungstène pour scie micro à guichet
Raspa al tungsteno per micro sega



68.24.19

Ersatz-Überwurfmutter für Spannfutter
Spare fixation nut for chuck
Tuerca de racor de repuesto para mandril de sujeción
Ecrou fileté pour mandrin de serrage
Dado a cappello di ricambio per mandrino

mit Fingerauflage
with finger-rest
con apoyo dedo
avec appui-doigt
con appoggiadita

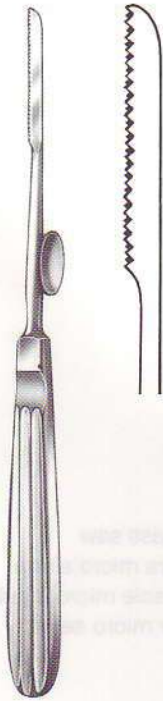

67.60.10
18,5 cm – 7 1/4"
Joseph



77.02.14
19 cm – 7 1/2"



77.02.23
23 cm – 9"
Langenbeck

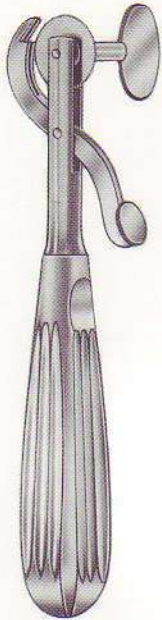

43.45.00
16 cm – 6¼"

43.45.00

Fingerringsäge komplett mit 1 Sägeblatt, verchromt
Finger Ring Cutter, complete with 1 saw blade, chromium-plated
Sierra para abrir anillos, completa, con 1 hoja de sierra, cromada
Scie pour couper les bagues, complète, avec 1 lame de scie, chromée
Sega per anelli, completa, con 1 lama per sega, cromata



43.45.01
Ersatzsägeblatt
Spare Saw Blade
Hoja de sierra de repuesto
Lame de scie
Lama di ricambio

904.30.12
Ersatznabe
Replacement hub
fleje de recambio
moyeu de rechange
mozzo di ricambio

904.30.10
Ersatzflügelmutter
Replacement wing
Tuerca de mariposa de requesto
Papillon de rechange
Dado ad alette di ricambio

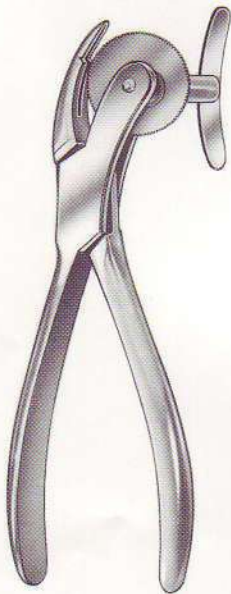

43.46.00
16 cm – 6¼"

43.46.00

Fingerringsäge komplett mit 1 Sägeblatt, verchromt
Finger Ring Cutter, complete with 1 saw blade, chromium-plated
Sierra para abrir anillos, completa, con 1 hoja de sierra, cromada
Scie pour couper les bagues, complète, avec 1 lame de scie, chromée
Sega per anelli, completa, con 1 lama per sega, cromata

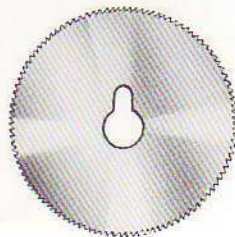

43.46.01
Ersatzsägeblatt
Spare Saw Blade
Hoja de sierra de repuesto
Lame de scie
Lama di ricambio

904.30.06
Ersatznabe
Replacement hub
fleje de recambio
moyeu de rechange
mozzo di ricambio

904.30.09
Ersatzflügelmutter
Replacement wing
Tuerca de mariposa de requesto
Papillon de rechange
Dado ad alette di ricambio

Hinweis: Elektrische Gipssäge und Zubehör
siehe Seiten 224 – 226.

Indication: Electric Plaster Saw and Accessories
on page 224 – 226.

Indicación: Sierra eléctrica de yeso y accesorios
vease paginas 224 – 226.

Indication: Scie électrique à plâtre et accessoires
voir pages 224 – 226.

Indicazione: Sega elettrica per gesso ed accessori
veda le pagine 224 – 226.



00.85.2A
18 cm - 8 1/2"



00.85.2A
18 cm - 8 1/2"

43.40.00
Fingernagel-Instrumente
Finger Nail Drills
Perforadores para uñas
Instruments à ongles
Strumenti per unghie



43.40.00
Fingernagel-Instrumente
Finger Nail Drills
Perforadores para uñas
Instruments à ongles
Strumenti per unghie



Fingernagel-Instrumente
Finger Nail Instruments
Instrumentos para uñas
Instruments à ongles
Strumenti per unghie

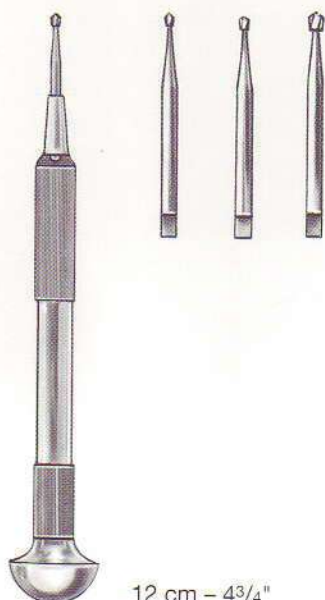

12 cm - 4³/₄"

43.40.00

Nagelbohrer komplett mit 3 Bohrern 1,2 - 1,6 - 2,0 mm
Finger Nail Drill complete with 3 drills 1.2 - 1.6 - 2.0 mm
Perforador de uñas completo con 3 perforadores 1,2 - 1,6 y 2,0 mm
Perforateur à ongle complet avec 3 forets 1,2 - 1,6 et 2,0 mm
Trapano per unghie completo di 3 perforatori 1,2 - 1,6 - 2,0 mm

43.40.10

Bohrer allein zu 43.40.00, Satz/3 Stück
Drills for 43.40.00, set of 3
Perforadores, sueltos, para 43.40.00 juego de 3
Forets, seuls, pour 43.40.00, jeu de 3
Trapano solo per 43.40.00, serie/3 pezzi

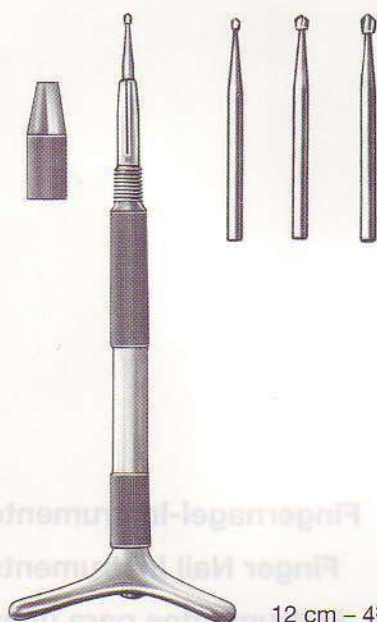

12 cm - 4³/₄"

43.40.50

Nagelbohrer komplett mit 3 Bohrern 1,2 - 1,6 - 2,0 mm
Finger Nail Drill complete with 3 drills 1.2 - 1.6 - 2.0 mm
Perforador de uñas completo con 3 perforadores 1,2 - 1,6 y 2,0 mm
Perforateur à ongle complet avec 3 forets 1,2 - 1,6 et 2,0 mm
Trapano per unghie completo di 3 perforatori 1,2 - 1,6 - 2,0 mm

43.40.60

Bohrer allein zu 43.40.50, Satz/3 Stück
Drills for 43.40.50, set of 3
Perforadores, sueltos, para 43.40.50 juego de 3
Forets, seuls, pour 43.40.50, jeu de 3
Trapano solo per 43.40.50, serie/3 pezzi

Nagelausreibzange
Nail Pulling Forceps
Pinza arranca uñas
Pince pour arracher les ongles
Pinza per togliere unghie



43.48.15
13,5 cm - 5³/₈"
Radolf

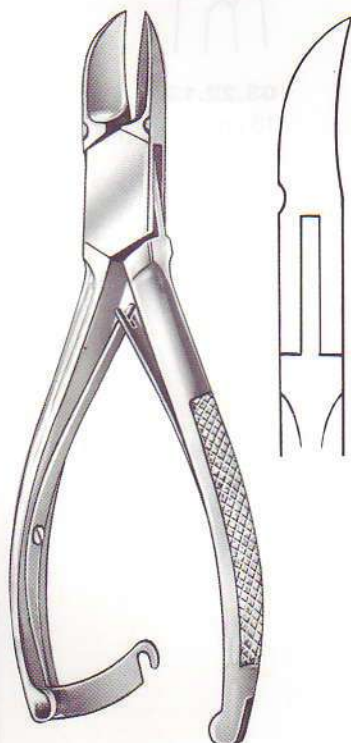

43.75.14
14 cm - 5¹/₂"

Nagelspaltzange
Nail Splitter
Pinza corta uñas
Pince pour fendre les ongles
Pinza tagliente per fendere unghie

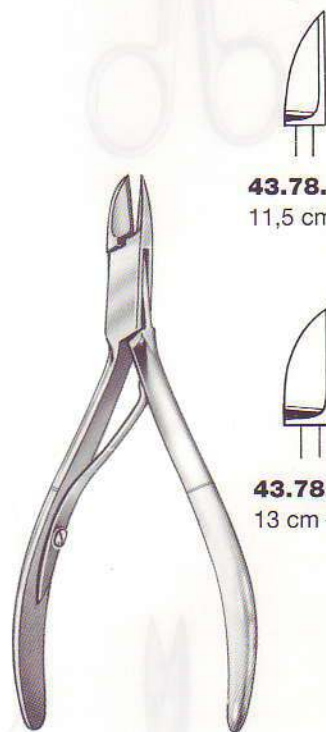

43.78.11
11,5 cm - 4¹/₂"

43.78.13
13 cm - 5¹/₈"

Nagelspaltschere
 Nail Splitting Scissors
 Tijeras para hender uñas
 Ciseaux à fendre les ongles
 Forbici per fendere unghie



03.22.13
 13 cm - 5 1/8"

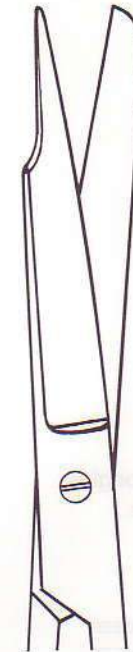

03.22.15
 15 cm - 5 3/4"

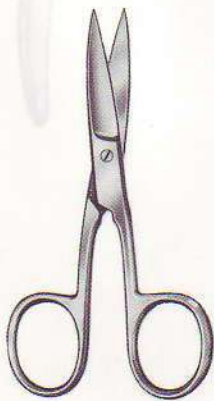

43.62.10
 10,5 cm - 4 1/8"

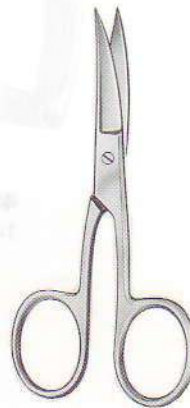

43.63.10
 10,5 cm - 4 1/8"

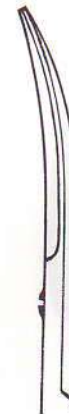

Sehnenzangen
 Tendon Grasping Forceps
 Pinzas para sujetar tendones
 Pinces pour saisir les tendons
 Pinças par agarrar tendão

Sehnenzangen
 Tendon Holding Forceps
 Pinzas para sujetar tendones
 Pinces à préhension pour tendons
 Pinças por agarrar tendão



78.18.03
3 mm



78.18.02
2 mm



78.18.08
2 mm



78.18.04
4 mm



78.18.03
3 mm

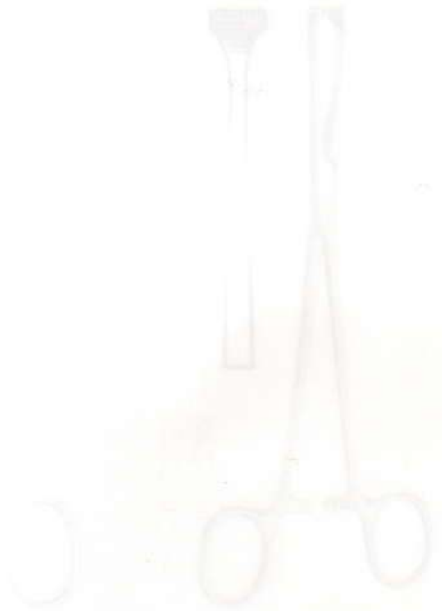

80.03.18
18 cm - 6 1/2"
Sehnenzangen "AT"

Sehnenzangen
 Tendon Grasping Forceps
 Pinzas para sujetar tendones
 Pinces pour saisir les tendons
 Pinças de presa par tendão



Sehnen-Instrumente
Tendon Instruments
Instrumentos para tendones
Instruments pour tendons
Strumento per tendine

71.10.11
11 cm - 4 1/2"
Groll

77.07.13
13,5 cm - 5 1/4"
Ombudsman
(Jackson)

Sehnenhalte-zangen
 Tendon Holding Forceps
 Pinzas para sujetar tendones
 Pinces à préhension pour tendons
 Pinza per afferrare tendini

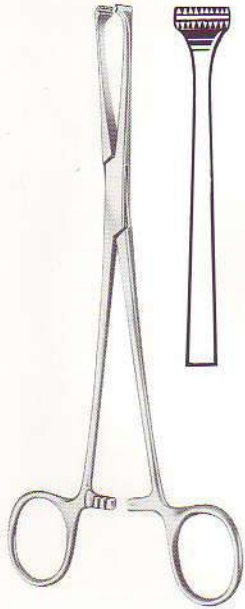

50.03.16
 16 cm – 6 1/4"
Steinmann "AT"

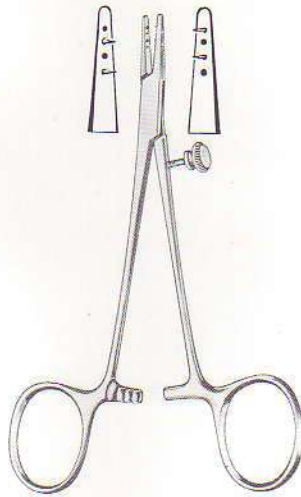

78.12.13
 13 cm – 5 1/8"
Steinmann

Sehnenfaßpinzetten
 Tendon Grasping Forceps
 Pinzas para agarrar tendones
 Pinces pour saisir les tendons
 Pinza per afferrare tendini



10 cm – 4"
Larsen



78.15.02
 2 mm



78.15.03
 3 mm

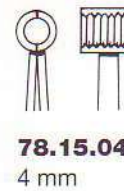

78.15.04
 4 mm

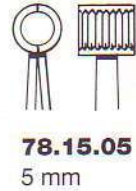

78.15.05
 5 mm

Sehnenfaßzangen
 Tendon Grasping Forceps
 Pinzas para agarrar tendones
 Pinces pour saisir les tendons
 Pinza da presa per tendini



78.10.11
 11 cm – 4 3/8"
Caroll



17.57.13
 13,5 cm – 5 3/8"
Ombredanne
(Jackson)

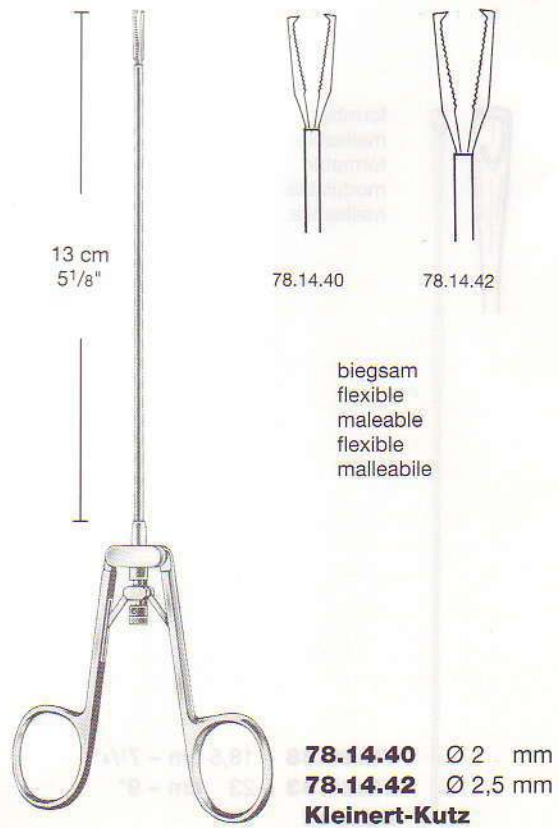
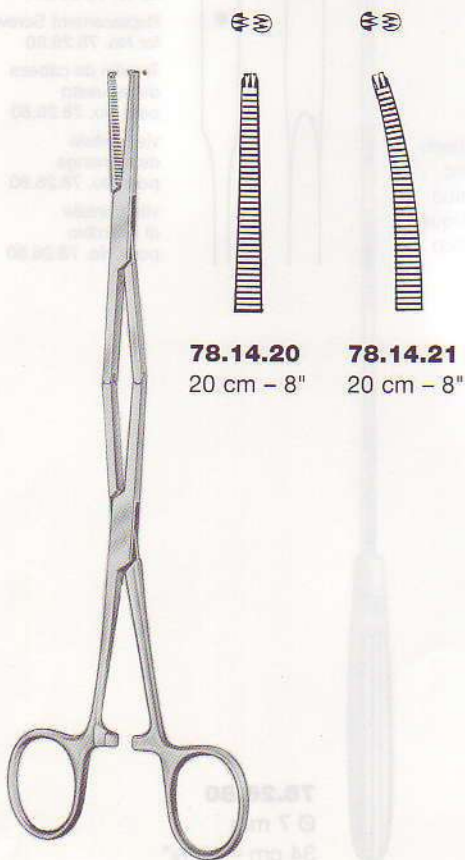
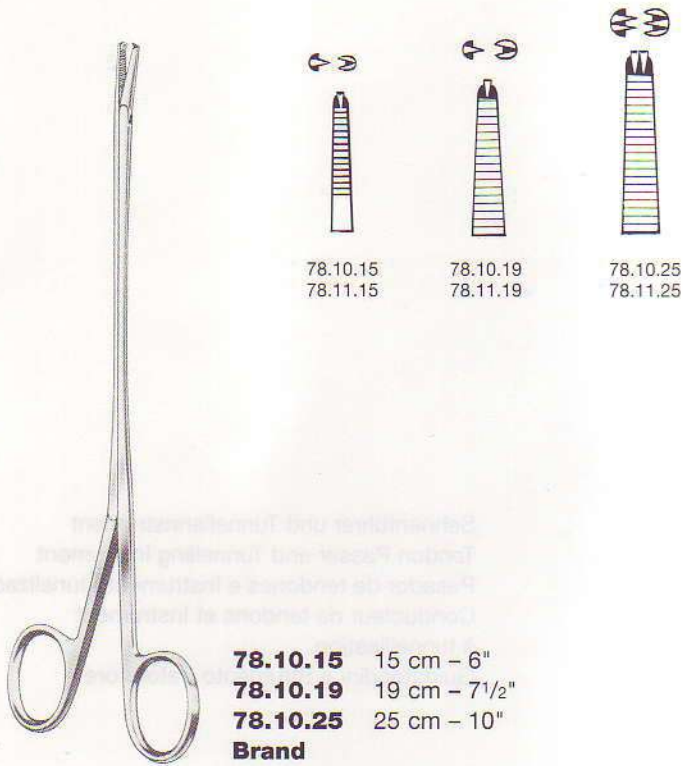



78.26.10
 15 cm - 6"
Framer



78.26.12
 15 cm - 6"
Framer

Sehnenführer und Tunnelierinstrument
 Tendon Passer and Tunneling Instrument
 Pasador de tendones e Instrumento tunelizador
 Conducteur de tendons et Instrument
 à tunnellation
 Guidatendini e Strumento traforatore

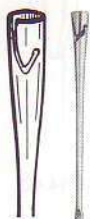

formbar
 malleable
 formable
 modulable
 malleabile

78.26.58 18,5 cm - 7 1/4"
78.26.63 23 cm - 9"
Bunnell

elastisch
 elastic
 elástico
 élastique
 elastico

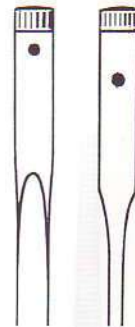

78.26.81
 Ersatz-Kopfschraube
 für Nr. 78.26.80
 Replacement Screw
 for No. 78.26.80
 Tornillo de cabeza
 de repuesto
 para No. 78.26.80
 vis frontale
 de rechange
 pour No. 78.26.80
 vite frontale
 di ricambio
 per il No. 78.26.80



78.26.80
 Ø 7 mm
 34 cm - 13 3/8"

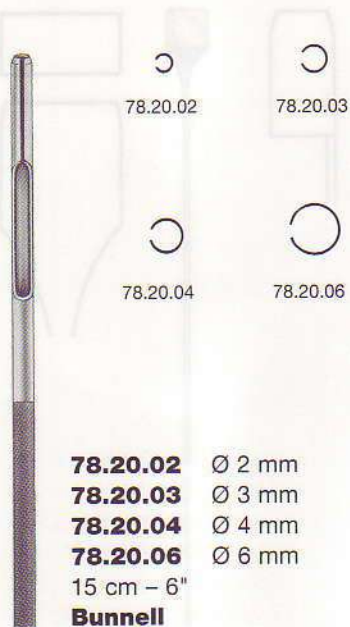

78.20.02 Ø 2 mm
78.20.03 Ø 3 mm
78.20.04 Ø 4 mm
78.20.06 Ø 6 mm
 15 cm - 6"
Bunnell

Ø = Innendurchmesser
 Ø = inside diameter
 Ø = diametro interior
 Ø = diamètre intérieur
 Ø = diametro interno

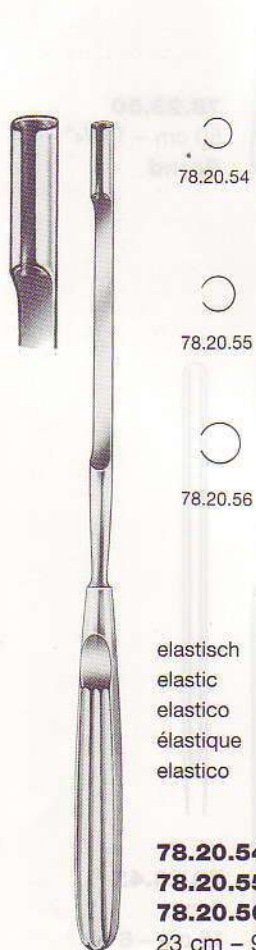

elastisch
 elastic
 elastico
 élastique
 elastico

78.20.54 Ø 4,0 mm
78.20.55 Ø 4,5 mm
78.20.56 Ø 5,5 mm
 23 cm - 9"

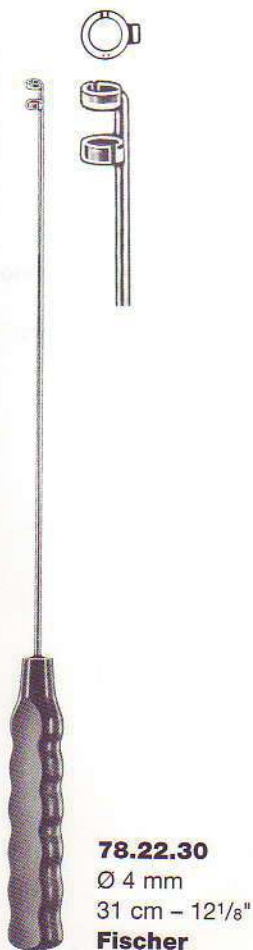

78.22.30
 Ø 4 mm
 31 cm - 12¹/₈"
Fischer

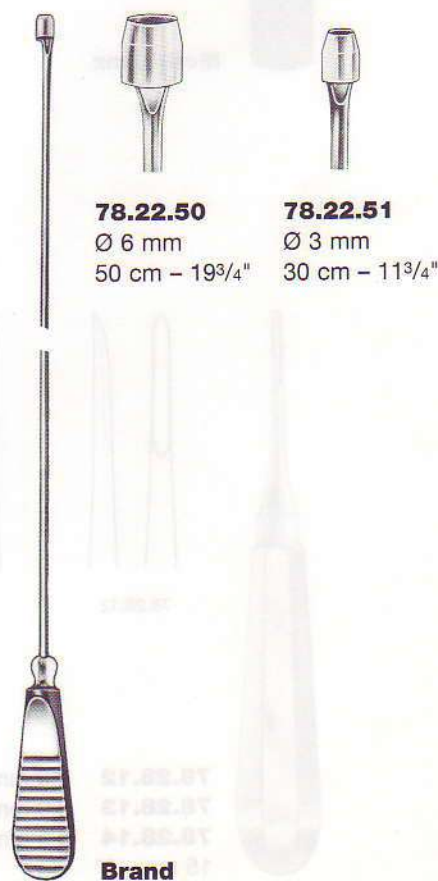

78.22.50 Ø 6 mm
 50 cm - 19³/₄"
78.22.51 Ø 3 mm
 30 cm - 11³/₄"

Brand



78.22.53
Ø 3 mm
34,5 cm - 13¹/₂"

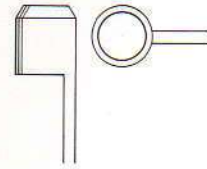

78.22.52
Ø 6 mm
50 cm - 19³/₄"

Ø = Innendurchmesser
Ø = inside diameter
Ø = diametro interior
Ø = diamètre intérieur
Ø = diametro interno

Mod. Lanz

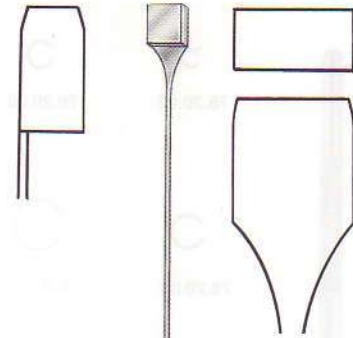

78.23.50
50 cm - 19³/₄"
Brand

Sehenschälmeißel
Tendon Gouges
Escoplos enucleadores de tendones
Décolleurs de tendons
Scalpelli enucleatori per tendini

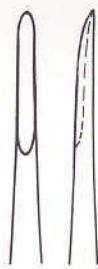

78.28.12

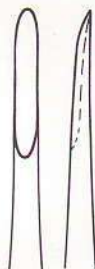

78.28.13



78.28.14

78.28.12 2,5 mm
78.28.13 3,0 mm
78.28.14 3,5 mm
15 cm - 6"



78.28.43
3 mm
16 cm - 6¹/₄"



78.12.16
15 cm - 6"



78.12.15
15 cm - 6"



18.12.19
15 cm - B

18.12.19
15 cm - B



51.20.02
"A" - no 87
Länge 2 x 2
Höhe 2 x 2
Breadth 2 x 2
Width 2 x 2
Depth 2 x 2



50.02
"A" - no 87
Länge 2 x 2
Höhe 2 x 2
Breadth 2 x 2
Width 2 x 2
Depth 2 x 2



"A"



"A"



Gewebefäßzangen
Tissue Grasping Forceps
Pinzas para coger tejidos
Pinces pour saisir les tissus
Pinze per afferare tessuti



Allis-Baby



50.02.13
 13 cm - 5 1/8"



50.02.14
 14 cm - 5 1/2"



Allis

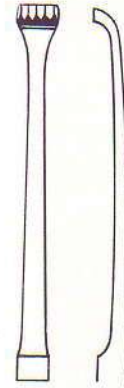

50.02.15
 15 cm - 6"
 4 x 5 Zähne
 4 x 5 teeth
 4 x 5 dientes
 4 x 5 dents
 4 x 5 denti

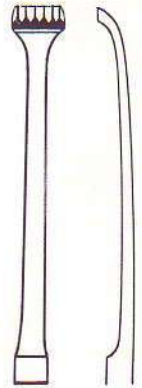

50.02.16
 16 cm - 6 1/4"
 5 x 6 Zähne
 5 x 6 teeth
 5 x 6 dientes
 5 x 6 dents
 5 x 6 denti

"AT" = atraumatische Riefung
 atraumatic serrations
 con estriado atraumático
 avec striure atraumatique
 striatura atraumatica

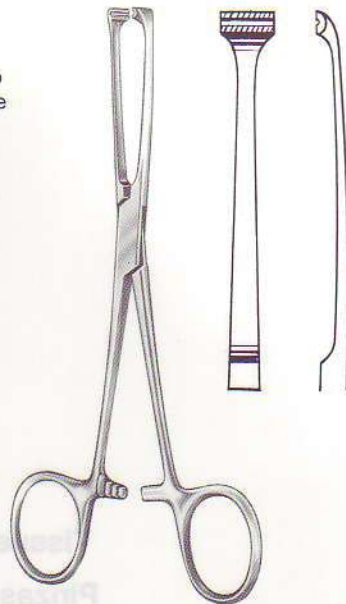

50.03.16
 16 cm - 6 1/4"
Allis "AT"



88.00.02

220 Volt

MEDICON-BIPOLAR

Hochfrequenz-Chirurgiegerät für bipolare Koagulation mit stufenlos einstellbarer Hochfrequenzleistung bis max. 50 Watt, Aktivierung wahlweise über Fußschalter oder automatisch.

High frequency bipolar coagulator with continuously adjustable high frequency output up to max. 50 watt. Activation either by foot-switch or automatically.

Equipo quirúrgico de alta frecuencia para coagulación bipolar con rendimiento de alta frecuencia con regulación continua hasta 50 vatios máximo. Activación por pedal o automáticamente.

Appareil pour la chirurgie haute fréquence pour coagulation bipolaire au moyen d'une puissance de haute fréquence réglable sans gradations jusqu'à 50 watts. Activation soit par pédale soit automatiquement.

Apparecchio chirurgico ad alta frequenza per coagulazione bipolare con capacità di alta frequenza regolabile lineare fino a 50 watt. Attivazione o per mezzo d'interruttore a pedale o automaticamente.

Technische Daten:

Netzanschluß 220 V, $\pm 10\%$, 50 Hz (110 V auf Anfrage lieferbar). Ableitstrom im Schutzleiter kleiner als 0,02 mA. Leistungsaufnahme max. 110 VA. HF-Leistung bis 50 Watt stufenlos einstellbar. Betriebsfrequenz 600 KHz. Abmessungen: 265 mm breit, 210 mm tief, 110 mm hoch. Gewicht 4,2 kg

Technical specification:

Electric mains 220 V, $\pm 10\%$, 50 cps (110 V available on request). Operating circuit in grounded conductor below 0,02 mA. Power Consumption max. 110 VA. High frequency output up to 50 watt continuously adjustable. Operating frequency 600 KHz. Dimensions: width 265 mm, depth 210 mm, height 110 mm. Weight 4.2 kg.

Datos técnicos:

Conexión a la red 220 voltios, $\pm 10\%$, 50 c.p.s. (a su demanda también suministrable de 110 V). Corriente de trabajo en el conductor de protección inferior a 0,02 mA. Potencia absorbida 110 VA máxima. Potencia de alta frecuencia con regulación continua hasta 50 vatios. Frecuencia de servicio 600 KHz. Medidas: 265 mm de ancho, 210 mm de profundidad, 110 mm de alto. Peso 4,2 kg.

Données techniques:

Branchement au réseau 220 volts, $\pm 10\%$, 50 c.p.s. (sur demande aussi livrable pour tension de 110 volts). Courant de travail dans le fil de protection inférieur à 0,02 mA. Puissance absorbée 110 VA maximum. Rendement de haute-fréquence réglable sans gradation jusqu'à 50 watts. Fréquence de service 600 KHz. Dimensions: 265 mm de large, 210 mm de profondeur, 110 mm de hauteur. Poids 4,2 kg.

Dati tecnici:

Collegamento alla rete 220 volt, $\pm 10\%$, 50 c.p.s. (a richiesta fornibile anche per tensione di 110 volt). Corrente di lavoro nel cavo protetto inferiore a 0,02 mA. Potenza assorbita 110 VA massimo. Capacità di alta frequenza fino a 50 watt, regolabile lineare. Frequenza di lavoro 600 KHz. Misure: larghezza mm. 265, profondità mm. 210, altezza mm. 110. Peso kg 4,2.



88.00.10
88.00.11

Fußschalter allein zum Bipolar-
 gerät Nr. 88.00.02, komplett mit
 Zuleitungskabel

88.00.10 nicht explosionsgeschützt
88.00.11 explosionsgeschützt

Foot Switch only for the
 bipolar unit no. 88.00.02,
 complete with connecting cable

88.00.10 non-explosion-proof
88.00.11 explosion-proof

Conmutador a pedal, suelto, para equipo
 bipolar No. 88.00.02, completo con cable
 de conexión

88.00.10 sin protección de explosión
88.00.11 con protección de explosión

Interrupteur à pédale, seul, pour
 l'appareil bipolaire No. 88.00.02,
 complet, avec câble d'amenée

88.00.10 sans protection antidéflagrante
88.00.11 antidéflagrant

Interruttore a pedale, solo, per
 l'apparecchio bipolare No. 88.00.02,
 completo di cavo di collegamento

88.00.10 non antideflagrante
88.00.11 antideflagrante

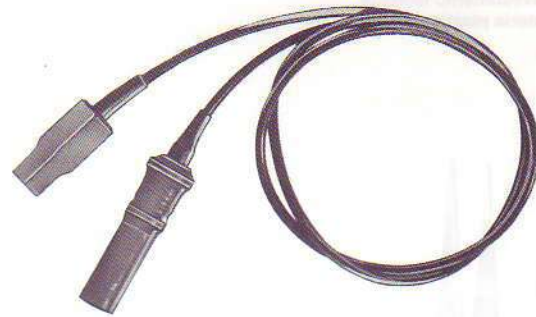

88.00.20 3 m
88.00.21 5 m

Kabel, zweipolig, zum Anschluß
 der MEDICON-Bipolarpinzetten
 an Bipolargerät Nr. 88.00.02

Bipolar cable for connecting
 MEDICON bipolar forceps to the
 bipolar unit no. 88.00.02

Cable, bipolar, para conectar las
 pinzas bipolares MEDICON al
 equipo bipolar No. 88.00.02

Câble bipolaire, pour la connexion
 des pinces bipolaires MEDICON
 à l'appareil bipolaire No. 88.00.02

Cavo, bipolare, per il collegamento
 delle pinzette bipolari MEDICON
 all'apparecchio bipolare No. 88.00.02

mit sterilisierfähiger Kunststoff-
 Isolierbeschichtung
 with insulation coating
 of autoclavable plastic
 con recubrimiento aislante
 de materia plástica esterilizable
 à enduit plastique isolant, stérilisable
 con rivestimento isolante
 in materia plastica sterilizzabile

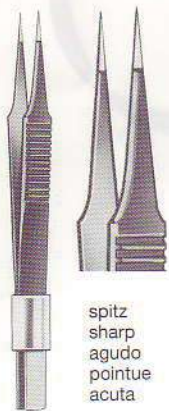

spitz
 sharp
 agudo
 pointue
 acuta

88.12.05
 11 cm - 4³/₈"



stumpf
 blunt
 romo
 mousse
 smussa

88.12.06
 11 cm - 4³/₈"



spitz
 sharp
 agudo
 pointue
 acuta

88.12.07
 11 cm - 4³/₈"

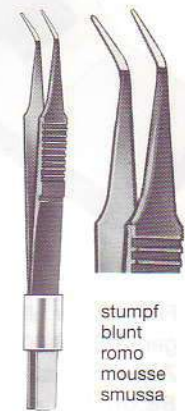

stumpf
 blunt
 romo
 mousse
 smussa

88.12.08
 11 cm - 4³/₈"



spitz
 sharp
 agudo
 pointue
 acuta

88.17.05
 16,5 cm - 6¹/₂"



stumpf
 blunt
 romo
 mousse
 smussa

88.17.06
 16,5 cm - 6¹/₂"



spitz
 sharp
 agudo
 pointue
 acuta

88.17.07
 16,5 cm - 6¹/₂"



stumpf
 blunt
 romo
 mousse
 smussa

88.17.08
 16,5 cm - 6¹/₂"

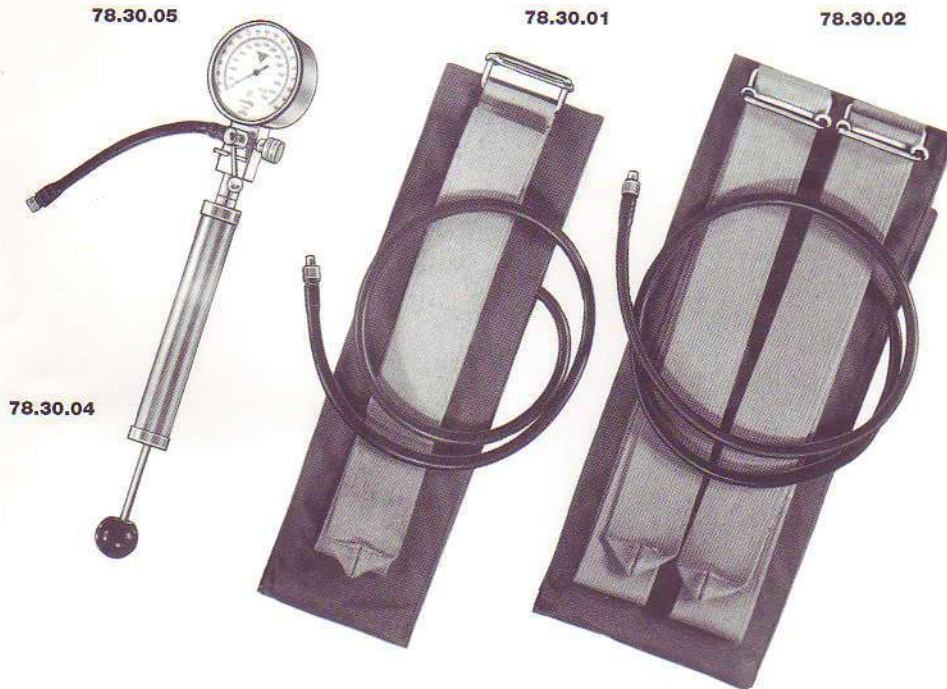

78.30.00

Komprimeter zur Erzeugung von Blutleere in den Extremitäten, bestehend aus:
1 Manometer verchromt mit Schlauch, gehärtete Kupfer-Beryllium Membrane und Skala bis 700 mmHg Nr 78.30.05; 1 Pumpe verchromt Nr. 78.30.04; 2 abwaschbare Manschetten mit Schlauch in den Größen 57 x 9 cm (Oberarmmanschette) Nr. 78.30.01 und 96 x 12,5 cm (Oberschenkelmanschette) Nr. 78.30.02.

Pneumatic tourniquet to avascularize the extremities, consisting of:
1 manometer No. 78.30.05, chrome-plated, with tube and tempered copper-beryllium membrane, scale up to 700mmHg; 1 pump No. 78.30.04, chrome-plated; 2 washable cuffs with tube sized 57 x 9 cm (upper arm cuff) No. 78.30.01 and 96 x 12,5 cm (thigh cuff) No. 78.30.02.

Comprimeter para producir el vacío de sangre en los miembros, compuesto por:
1 manómetro cromado con manguera, con membrana endurecida de cobre-berilio y escala hasta 700 mmHg No. 78.30.05; 1 bomba cromada No. 78.30.04; 2 brazaletes lavables con manguera en los tamaños 57 x 9 cm (brazaletes brazo) No. 78.30.01 y 96 x 12,5 cm (brazaletes muslo) No. 78.30.02.

Komprimeter permettant d'arrêter la circulation du sang dans les membres, comprenant:
1 manomètre chromé, avec tuyau, avec membrane en cuivre-béryllium trempé et échelle jusqu'à 700mmHg réf. 78.30.05; 1 pompe chromée réf. 78.30.04, 2 manchettes lavables avec tuyau, brassard réf. 78.30.01, 57 x 9 cm et cuissard réf. 78.30.02, 96 x 12,5 cm.

Apparechio di alta precisione per creare vuoti di sangue nelle estremità, composto di:
1 manometro cromato con tubo, membrana indurita di rame-berilio e scala graduata fino a 700mmHg no. 78.30.05; 1 pompa cromata no. 78.30.04; 2 bracciali lavabili con tubo lunghezza 57 x 9 cm (bracciale per braccio) no. 78.30.01 e lunghezza 96 x 12,5 cm (bracciale per coscia) no. 78.30.02.



Handschuhe
Operator
Bleihand
by bending the
for surgery and
weight of the lead
Medicine
weight of the lead
operator's duration
Bleihände
Lead Hands
Manoplas de plomo
Attelles de plomb
Mani di piombo



78.00.01

für Kinder
for children
para niños
pour enfants
per bambini

78.00.02

für Erwachsene
for adults
para adultos
pour adultes
per adulti

Durch Umbiegen der Lappen werden Hand und Finger in Operationslage festgehalten und durch das Gewicht der Bleihand zusätzlich immobilisiert.

By bending the lead flaps hand and fingers are kept in place for surgery and are at the same time immobilized by the weight of the lead hand.

Mediante dobladura de las lengüetas de la manopla por encima de los dedos, mano y dedos se sujetan en posición operatoria quedando inmovilizados adicionalmente por el peso del plomo.

Par pliere des languettes, main et doigts sont fixés en position d'opération et de plus immobilisés par le poids de l'attelle de plomb.

Ausilio importantissimo nella chirurgia della mano. Le linguette laterali ripiegate immobilizzano mano e dita anche col peso del piombo.

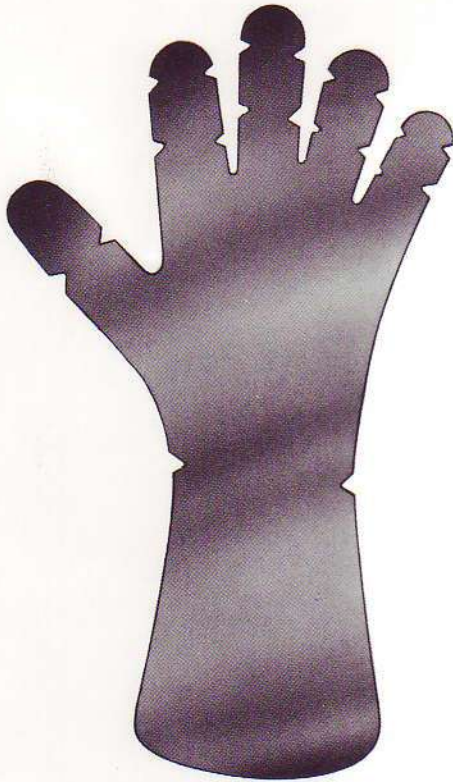

78.00.03

für Kinder
for children
para niños
pour enfants
per bambini

78.00.04

für Erwachsene
for adults
para adultos
pour adultes
per adulti

Gummiringe für Bleihände, autoklavierbar
Rubber bands for lead hands, autoclavable
Anillos de goma para manoplas de plomo, autoclavable
Anneaux en caoutchouc pour attelles de plomb, autoclavables
Anelli di gomma per mani di piombo, sterilizzabili in autoclave

Verpackungseinheit 5 Stück
Packing unit 5 pieces
Caja con 5 piezas
Boîtes de 5 pièces
Unità di 5 pezzi



78.00.05
Ø 22 mm



78.00.06
Ø 26 mm



78.00.07
Ø 31 mm

Ø = Innendurchmesser
Ø = inside diameter
Ø = diametro interior
Ø = diamètre intérieur
Ø = diametro interno



12.00.03
 12.00.03
 12.00.03
 12.00.03
 12.00.03

12.00.03
 12.00.03
 12.00.03
 12.00.03
 12.00.03

Handschuhe
 Manoplas
 Attelles
 Mani

Handschuhe
 Manoplas
 Attelles
 Mani

Handschuhe
 Manoplas
 Attelles
 Mani



12.00.01
 Ø 31 mm



12.00.02
 Ø 38 mm



12.00.03
 Ø 52 mm



02.90.18

Objetivul suplimentar (pairo) pentru amplificare la factor
de 2,5. Luneta la lampa 02.90.18; Gafas de lupa 02.90.18;
Magnifying Glasses (pair) for magnification power of 2,5.
Gafas de lupa 02.90.18; Luneta la lampa 02.90.18;
Objetivul suplimentar (pairo) pentru amplificare la factor de
2,5. Luneta la lampa 02.90.18; Gafas de lupa 02.90.18;
Magnifying Glasses (pair) for magnification power of 2,5.
Gafas de lupa 02.90.18; Luneta la lampa 02.90.18;

Objetivul suplimentar (pairo) pentru amplificare la factor
de 2,5. Luneta la lampa 02.90.18; Gafas de lupa 02.90.18;
Magnifying Glasses (pair) for magnification power of 2,5.
Gafas de lupa 02.90.18; Luneta la lampa 02.90.18;

Objetivul suplimentar (pairo) pentru amplificare la factor
de 2,5. Luneta la lampa 02.90.18; Gafas de lupa 02.90.18;
Magnifying Glasses (pair) for magnification power of 2,5.
Gafas de lupa 02.90.18; Luneta la lampa 02.90.18;

Objetivul suplimentar (pairo) pentru amplificare la factor
de 2,5. Luneta la lampa 02.90.18; Gafas de lupa 02.90.18;
Magnifying Glasses (pair) for magnification power of 2,5.
Gafas de lupa 02.90.18; Luneta la lampa 02.90.18;

Objetivul suplimentar (pairo) pentru amplificare la factor
de 2,5. Luneta la lampa 02.90.18; Gafas de lupa 02.90.18;
Magnifying Glasses (pair) for magnification power of 2,5.
Gafas de lupa 02.90.18; Luneta la lampa 02.90.18;

Objetivul suplimentar (pairo) pentru amplificare la factor
de 2,5. Luneta la lampa 02.90.18; Gafas de lupa 02.90.18;
Magnifying Glasses (pair) for magnification power of 2,5.
Gafas de lupa 02.90.18; Luneta la lampa 02.90.18;

Objetivul suplimentar (pairo) pentru amplificare la factor
de 2,5. Luneta la lampa 02.90.18; Gafas de lupa 02.90.18;
Magnifying Glasses (pair) for magnification power of 2,5.
Gafas de lupa 02.90.18; Luneta la lampa 02.90.18;

Objetivul suplimentar (pairo) pentru amplificare la factor
de 2,5. Luneta la lampa 02.90.18; Gafas de lupa 02.90.18;
Magnifying Glasses (pair) for magnification power of 2,5.
Gafas de lupa 02.90.18; Luneta la lampa 02.90.18;

Objetivul suplimentar (pairo) pentru amplificare la factor
de 2,5. Luneta la lampa 02.90.18; Gafas de lupa 02.90.18;
Magnifying Glasses (pair) for magnification power of 2,5.
Gafas de lupa 02.90.18; Luneta la lampa 02.90.18;



Lupenbrillen
Magnifying Glasses
Gafas de lupa
Lunettes à loupe
Occhiali d'ingrandimento



62.90.18

Lupenbrille mit Metallfassung, **1,8-fache Vergrößerung**; individuelle Anpassung der Lupenkörper an den Pupillenabstand; einzeln schwenkbare Lupen zur Einstellung des Konvergenzwinkels; geeignet für Vorsatzobjektive.

Magnifying spectacles in metal frame, **1.8 x magnification power**. The oculars are individually adjustable to the pupillary distance. The swivel loupes can be separately adjusted to the angle of convergence. Suitable for use of slip-on objectives.

Gafas de Lupa montura de metal, **aumento de 1,8**; adaptación individual de la lupa a la distancia interpupilar; lupas giratorias individualmente para el ajuste del ángulo de convergencia; adecuado para objetivos adicionales.

Lunettes à loupe avec monture en métal, **grossissement 1,8 fois**; les corps de loupe s'adaptent individuellement à la distance des pupilles; chaque loupe est pivotante pour l'ajustement de l'angle de convergence; utilisable pour des objectifs supplémentaires.

Occhiali d'ingrandimento con montatura in metallo, **con ingrandimento 1,8**; adattamento individuale della lente alla distanza della pupilla; singole lenti mobili per la regolazione dell'angolo di convergenza adatti per obiettivi addizionali anteriori.



62.90.25

Vorsatzobjektive (Paar) zur Erweiterung des Vergrößerungs-Faktors der Lupenbrille 62.90.18, **2,5-fache Vergrößerung**.

Slip-on objectives (pair) for increasing the magnification power of the spectacles 62.90.18, **2.5 x magnification**.

Objetivos adicionales (par) para el ajuste del factor de aumento de las gafas de lupa 62.90.18, **aumento de 2,5**.

Objectifs supplémentaires (paire) pour élargir le facteur de grossissement des lunettes à loupe réf. 62.90.18; **grossissement 2,5 fois**.

Obiettivi addizionali anteriori (paio) per ampliamento del fattore d'ingrandimento degli occhiali d'ingrandimento 62.90.18, **2,5 x ingrandimento**.



62.90.30

Lupenbrille mit Metallfassung, **2,5-fache Vergrößerung**; Optik vergütet und farbkorrigiert; individuelle Anpassung der Lupenkörper an den Pupillenabstand; einzeln schwenkbare Lupen zur Einstellung des Konvergenzwinkels.

Magnifying spectacles in metal frame, **2,5 x magnification power**. The optical system is colour-corrected and coated. The oculars are individually adjustable to the pupillary distance. Swivel loupes can be separately adjusted to the angle of convergence.

Gafas de lupa con montura de metal, **aumento de 2,5**; óptica con tratamiento antireflexión y corrección cromática; adaptación individual de la lupa a la distancia interpupilar, lupas giratorias individualmente para el ajuste del ángulo de convergencia.

Lunettes à loupe avec monture en métal, **grossissement 2,5 fois**; optique traitée, avec correction de la couleur: les corps de loupe s'adaptent individuellement à la distance des pupilles; chaque loupe est pivotante pour l'ajustement de l'angle de convergence.

Occhiali d'ingrandimento con montatura in metallo, **con ingrandimento 2,5**; ottica affinata e corretta di colore; adattamento individuale della lente alla distanza della pupilla; singole lenti mobili per la regolazione di convergenza dell'angolo.



62.90.49

Etui zur Aufbewahrung der Lupenbrillen 62.90.18 oder 62.90.30.

Case for magnifying spectacles 62.90.18 or 62.90.30.

Estuche para depositar las gafas de lupa 62.90.18 o 62.90.30.

Etui pour garder des lunettes à loupe réf. 62.90.18 ou réf. 62.90.30.

Astuccio per conservazione degli occhiali d'ingrandimento 62.90.18 o 62.90.30.



62.90.68

Binokulare Stirnlupe mit verstellbarem Kunststoff-Stirnband **1,8-fache Vergrößerung**; individuelle Anpassung der Lupenkörper an den Pupillenabstand; einzeln schwenkbare Lupen zur Einstellung des Konvergenzwinkels; geeignet für Vorsatzobjektive zur Erweiterung des Vergrößerungs-Faktors (Vorsatzobjektive siehe Seite 212).

Binocular headband loupe with adjustable plastic headband, **1.8 x magnification power**. The oculars are individually adjustable to the pupillary distance. The swivel loupes are separately adjustable to the angle of convergence. Suitable for use of slip-on objectives for increasing magnification power (slip-on objectives see page 212).

Lupa frontal binocular con cinta plástica ajustable, **aumento de 1,8**; adaptación individual de la lupa a la distancia interpupilar; lupas giratorias individualmente para el ajuste del ángulo de convergencia; adecuado para objetivos adicionales para la extensión del factor de aumento (objetivos adicionales véanse pág. 212).

Loupe frontale binoculaire avec bandeau frontal en matière plastique, réglable, **grossissement 1,8 fois**; les corps de loupe s'adaptent individuellement à la distance des pupilles; chaque loupe est pivotante pour l'ajustement de l'angle de convergence; utilisable pour des objectifs supplémentaires pour élargir le facteur de grossissement (objectifs supplémentaires, voir page 212).

Lente frontale binocular con fascia frontale in plastica regolabile con **ingrandimento 1,8**; adattamento individuale della lente alla distanza della pupilla; singole lenti movibili per la regolazione dell'angolo di convergenza; adatte per obiettivi addizionali anteriori per l'ampliamento del fattore di ingrandimento (obiettivi anteriori addizionali vedere pag. 212).



62.90.80

Binokulare Stirnlupe mit verstellbarem Kunststoff-Stirnband **2,5-fache Vergrößerung**; Optik vergütet und farbkorrigiert; individuelle Anpassung der Lupenkörper an den Pupillenabstand; einzeln schwenkbare Lupen zur Einstellung des Konvergenzwinkels.

Binocular headband loupe with adjustable plastic headband, **2,5 x magnification power**. The optical system is colour-corrected and coated. The oculars are individually adjustable to the pupillary distance. The swivel loupes can be separately adjusted to the angle of convergence.

Lupa frontal binocular con cinta plástica ajustable, **aumento de 2,5**; óptica con tratamiento antirreflexión y corrección cromática; adaptación individual de la lupa a la distancia interpupilar; lupas giratorias individualmente para el ajuste del ángulo de convergencia.

Loupe frontale binoculaire avec bandeau frontal en matière plastique, réglable, **grossissement 2,5 fois**; optique traitée, avec correction de la couleur; les corps de loupe s'adaptent individuellement à la distance des pupilles; chaque loupe est pivotante pour l'ajustement de l'angle de convergence.

Lente frontale binoculare con fascia frontale regolabile in plastica con **ingrandimento 2,5**; ottica affinata e corretta di colore; adattamento individuale delle lenti alla distanza della pupilla; singole lenti mobili per la regolazione dell'angolo di convergenza.



44.33.30
Drehmaß



44.33.30



44.33.30

Meßinstrumente - u. Zubehör
Measuring Instruments and Accessories

Meßinstrumente und Zubehör

Measuring Instruments and Accessories

Measuring Instruments and Accessories

Measuring Instruments and Accessories
Measuring Instruments and Accessories
Measuring Instruments and Accessories
Measuring Instruments and Accessories

Measuring Instruments and Accessories

44.33.30	15 cm - B
44.33.30	30 cm - B
44.33.30	30 cm - 110°
44.33.30	50 cm - 120°

Measuring Instruments and Accessories
Measuring Instruments and Accessories
Measuring Instruments and Accessories
Measuring Instruments and Accessories

**Meßinstrumente
Measuring Instruments
Instrumentos de medida
Instruments de mesure
Strumenti per la misura**

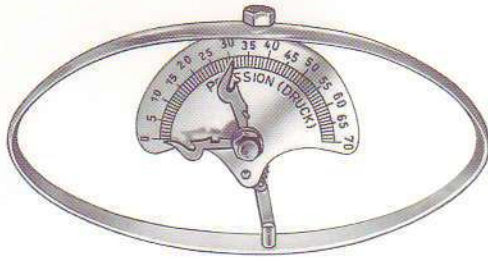

44.33.20
Collin

Dynamometer mit Kilo-Einteilung, für Erwachsene
 Dynamometer kilogram scale, adult size
 Dinamómetro graduado en kg, para adultos
 Dynamomètre avec graduation en kg, pour adultes
 Dinamometro con graduazione in kg, per adulti



44.35.15

Leinen-Bandmaß, 1,5 Meter, Zentimeter- u. Zolleinteilung
 Tape Measure, linen, graduated in centimeters and inches, 1.5 m - 5 ft.
 Cinta métrica de tela, centímetros y pulgadas; 1,5 m de largo
 Ruban métrique en toile, 1,5 m de long, en cm et pouces
 Nastro metrico di tela, m 1,5; in centimetri e pollici



44.36.20

Stahl-Bandmaß, 2 Meter, Zentimeter- u. Zolleinteilung
 Tape Measure, steel, graduated in centimeters and inches, 2 m - 6½ ft.
 Cinta métrica de metal, centímetros y pulgadas; 2 m de largo
 Ruban métrique en acier, 2 m de long, en cm et pouces
 Nastro metrico d'acciaio, m 2; in centimetri e pollici



- 44.37.15** 15 cm - 6"
- 44.37.20** 20 cm - 8"
- 44.37.30** 30 cm - 11¼"
- 44.37.50** 50 cm - 19¾"

Stahl-Meßstab, rostfrei, Zentimeter- und Zolleinteilung
 Rule, stainless steel, graduated in centimeters and inches
 Regla de acero inoxidable, centímetros y pulgadas
 Règle en acier inoxydable, graduée en cm et en pouces
 Riga graduata in acciaio inossidabile, in centimetri e pollici

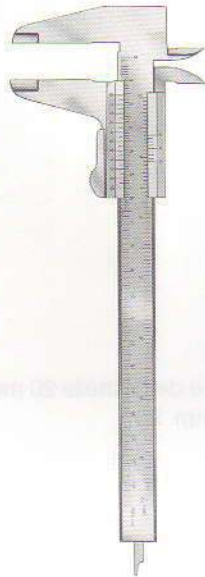

Meßbereich:
Measuring range:
Alcance de medición:
Etendue de mesure:
Campo di misura: } 150 mm

44.38.05
22 cm – 8¾"

Schieblehre mit Millimeter- und Zolleinteilung
Caliper graduated in millimeters and inches
Calibrador graduado en milímetros y pulgadas
Pied à coulisse gradué en mm et en pouces
Calibro micrometrico con graduazione in millimetri e pollici

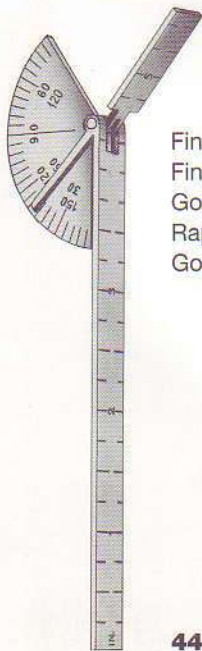

Finger-Goniometer
Finger Goniometer
Goniómetro para dedos
Rapporteur (Goniomètre) pliant
Goniometro per le dita

44.38.30

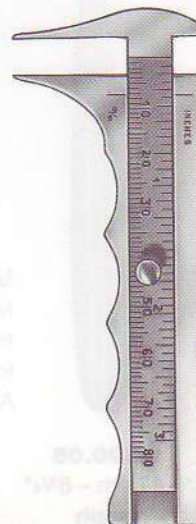

Schieblehre mit
Millimeter- und Zolleinteilung
Caliper graduated
in millimeters and inches
Calibrador graduado
en milímetros y pulgadas
Pied à coulisse gradué en
mm et en pouces
Calibro micrometrico con
graduazione in millimetri e pollici

60.00.30
10 cm – 4"
Jameson



60.00.40
8,5 cm - 3³/₈"
Castroviejo

Zirkel mit 20 mm Skala
Caliper with 20 mm scale
Compás, con escala de 20 mm
Compas à pointes sèches, portée de l'échelle 20 mm
Compasso con scala, apertura mm. 20



mit Zentimeter-Graduierung
graduated in centimeters
con graduación en centímetros
gradué en cm
centimetrato

Meßstab
Measuring Instrument
Instrumento para medir
Instrument-mesureur
Asta graduata

67.90.05
17 cm - 6³/₄"
Joseph



**Verband- und Gipsinstrumente
 Bandage and Plaster Instruments
 Instrumentos de vendajes y yeso
 Instruments à pansements et à plâtre
 Strumenti per bendaggi e gessi**

40.22.04
 18 cm - 8 1/2"
 Liston-Excentric

18 cm - 7 1/8"
 240.22.20 20 cm - 8"
 Liston-superior

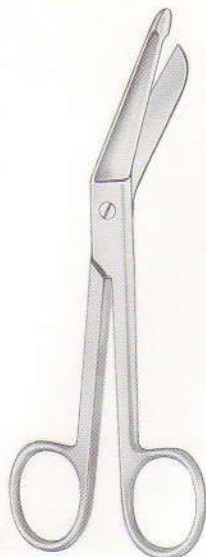

40.25.14
14 cm - 5 1/2"
Lister



240.25.14
14 cm - 5 1/2"
Lister-supercut

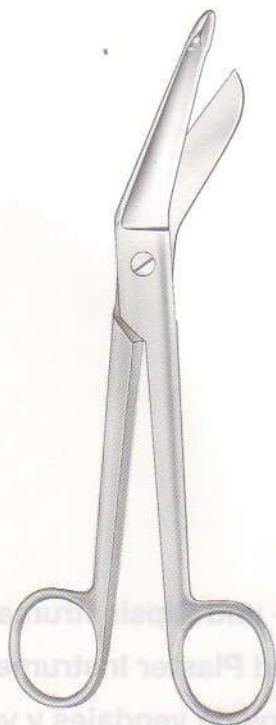

40.25.18 18 cm - 7 1/8"
40.25.20 20 cm - 8"
Lister



240.25.18 18 cm - 7 1/8"
240.25.20 20 cm - 8"
Lister-supercut

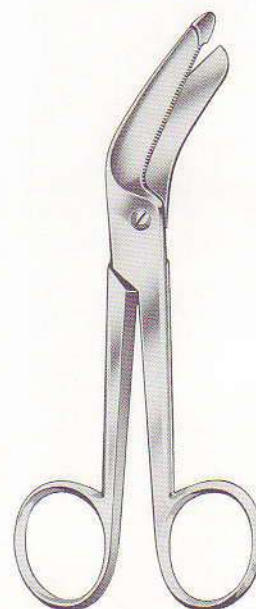

40.25.96
16 cm - 6 1/4"
Lister-Excentric

Gipsschere
Plaster Shears
Cizalla para yeso
Cisaille à plâtre
Cesoie per gesso

Gipsabreißzange
Plaster Cast Breaker
Pinza para arrancar vendajes enyesados
Pince pour arracher les plâtres
Pinza strappagessi

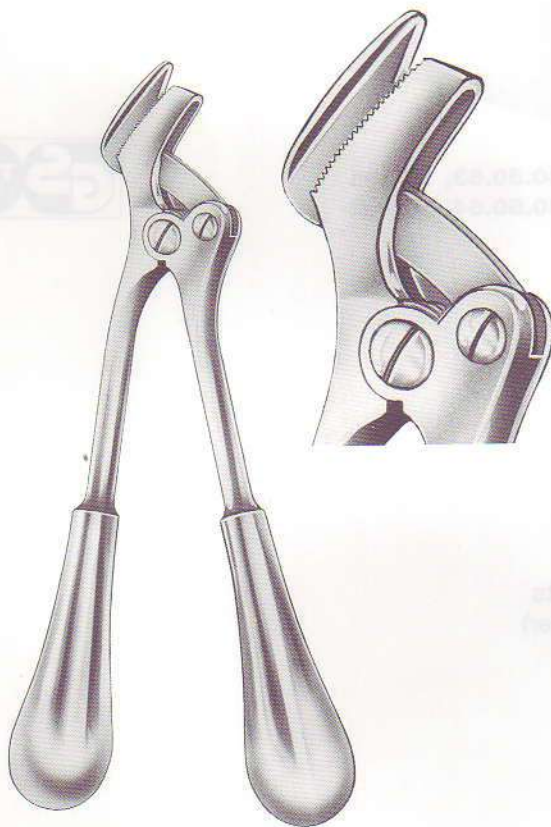

40.55.20
20 cm - 8"
Stille-mini



40.81.18
18 cm - 7¹/₈"
Wolff-Boehler

- Robuste Konstruktion
- Hohe Belastbarkeit im Dauerbetrieb
- Vibrationsarm
- Eingebauter Überlastungsschutz
- Wartungsfrei
- Gewicht nur 1,2 kg (ohne Kabel)
- 1 Jahr Garantie auf Motor und Sägeteil (bei sachgemäßer Behandlung)

„OSCILLO IV“



40.50.63, 110 Volt
40.50.64, 220 Volt



- Robust construction
- Maximum capacity also in permanent service
- Low vibration
- Built-in overload protection
- Maintenance free
- Weight only 1.2 kg (without cable)
- One year guarantee on motor and saw components (on condition the machine is used in the proper manner)

- construcción robusta
- alta capacidad de carga también en régimen continuo
- amortiguación de la vibración
- protección incorporada contra sobrecarga
- no requiriendo servicio de mantenimiento
- pesando 1,2 kg solamente (sin cable)
- un año de garantía sobre motor (excepto los casos de trato no apropiado)

- Construction robuste
- Capacité de charge élevée en régime permanent
- Vibration amortie
- Protection incorporée contre les surcharges
- Pas de service d'entretien
- Poids réduit de 1,2 kg (sans câble)
- Une année de garantie sur le moteur et les éléments de sciage (excepté les cas de traitement non-conforme)

- Costruzione robusta
- Alta capacità di carico in servizio continuo
- Vibrazioni attenuate al minimo
- Protezione di sovraccarico incorporata
- Non richiede manutenzione
- Peso di kg. 1,2 (senza cavo)
- Un'anno di garanzia per motore e testa segatrice (ad eccezione de uso non conforme)

„OSCILLO IV“

40.50.63, 110 Volt
40.50.64, 220 Volt

oszillierende elektrische Gipssäge, robustes Modell für starke Belastung (ca. 15 000 Schwingungen pro Minute).
komplett in Karton:
1 Kreissägeblatt Ø 50 mm, Nr. 40.50.68
1 Kreissägeblatt Ø 65 mm, Nr. 40.50.69
2 Gabelschlüssel für Sägeblattwechsel Nr. 40.50.71 (Paar)
1 Gebrauchsanleitung

Oscillating Electric Plaster Saw, robust model for high load, (approx. 15 000 oscillations/minute).
complete in carton:
1 circular saw blade 50 mm (2") diam., no. 40.50.68
1 circular saw blade 65 mm (2½") diam., no. 40.50.69
2 wrenches no. 40.50.71 (pair)
1 Operating instructions booklet

Sierra eléctrica oscilante para cortar vendajes enyesados, modelo robusto, 15 000 oscilaciones aprox./min.
completa de:
1 hoja de sierra circular, Ø 50 mm, No. 40.50.68
1 hoja de sierra circular, Ø 65 mm, No. 40.50.69
2 llaves para cambiar las hojas de sierra No. 40.50.71 (par)
1 instrucción para el uso en cajita de cartón.

Scie électrique oscillante pour bandages plâtrés, modèle robuste, pour charge forte (env. 15 000 oscillations/min.)
complète, en boîte:
1 lame de scie circulaire, 50 mm de Ø, No. 40.50.68
1 lame de scie circulaire, 65 mm de Ø, No. 40.50.69
2 clefs No. 40.50.71 (paire), pour changer la lame
1 mode d'emploi

Sega elettrica oscillante per bendaggi gessati, modello robusto per carico forte (circa 15 000 oscillazioni p. min.)
completa in scatola di cartone:
1 Lama circolare Ø mm. 50 No. 40.50.68
1 Lama circolare Ø mm. 65 No. 40.50.69
2 chiavi per cambiare le lame No. 40.50.71 (paio)
1 Mode d'uso

Technische Daten:
220 Volt Wechselstrom, 50 Hz
Leistungsaufnahme 125 Watt
Anschlußkabel 3 m lang
 Schutzisoliert
Bild- und Tonfunktentstörung

Technical Data:
220 Volt, A.C., 50 cycles
Input 125 Watt
Connecting Cable 3 m (10 ft)
 Double insulated
TV- and radio suppressed

Datos técnicos:
220 voltios corriente alterna, 50 Hz
potencia absorbida 125 vatios
cable de alimentación 3 m de largo
 aislamiento protector
radiodifusión y televisión
al abrigo de perturbaciones

données techniques:
220 V courant alternatif, 50 Hz
Puissance absorbée 125 W
Câble d'alimentation 3 m de long
 Isolement protecteur
T.S.F. et télévision
à l'abri de parasites

Caratteristiche tecniche:
220 volt corrente alternata 50 c.p.s.
Potenza assorbita 125 watt
Cavo di connessione, lunghezza m. 3
 Isolamento protettivo
Radiodiffusione e televisione
libre da interferenze

„OSCILLO IV“

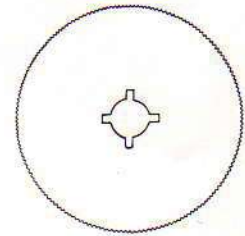

Kreissägeblätter für Kunststoff- und Fiberglas-Hartverbände
 Circular saw blades for synthetic and fibre-glass dressings
 Hojas de sierra circular para vendajes duros de materia plástica y de fibra de vidrio
 Lames de scie circulaires pour des pansements durs en matière plastique ou en fibre de verre
 Lame circolari per fasciature dure di materia plastica e per fasciature di vetro fibroso

40.50.65 Ø 50 mm
40.50.66 Ø 65 mm

Kreissägeblätter für Naturgips
 Circular saw blades for plaster
 Hojas de sierra circular para vendaje de yeso
 Lames de scie circulaires pour plâtre naturel
 Lame circolari per gessi

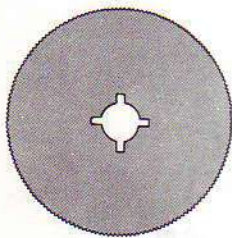

40.50.68 Ø 50 mm
40.50.69 Ø 65 mm

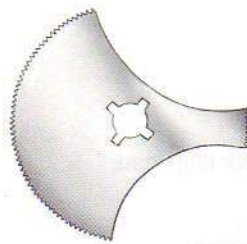

40.50.72

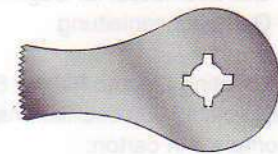

40.50.73

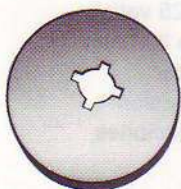

40.50.74
 Ø 65 mm

Gabelschlüssel
 Wrenches
 llaves
 clefs
 Ciavi



40.50.71
 Paar
 pair
 par
 paire
 paio

exzentrische Begrenzungsscheibe für Kreissägeblätter
 Nr. 40.50.66 und 40.50.69

eccentric disc for circular saw blades
 No. 40.50.66 and 40.50.69 to limit depth of cut

disco excéntrico para limitar la profundidad del corte
 para sierras circulares 40.50.66 y 40.50.69

disque excentrique pour limiter la profondeur de la coupe,
 pour lames de scie circulaires réf. 40.50.66 et réf. 40.50.69

disco eccentrico per lame da seghe circolari
 Nr. 40.50.66 e 40.50.69



**Etuis
Sterilisieretuis
Sterilisiergestelle**

**Cases
Sterilizing Boxes
Sterilizing Racks**

**Estuches
Estuches de esterilización
Bastidores para esterilizar instrumentos**

**Etuis
Boîtes de stérilisation
Cadres de stérilisation et de rangement**

**Astucci
Astucci per sterilizzazione
Supporti per sterilizzazione**

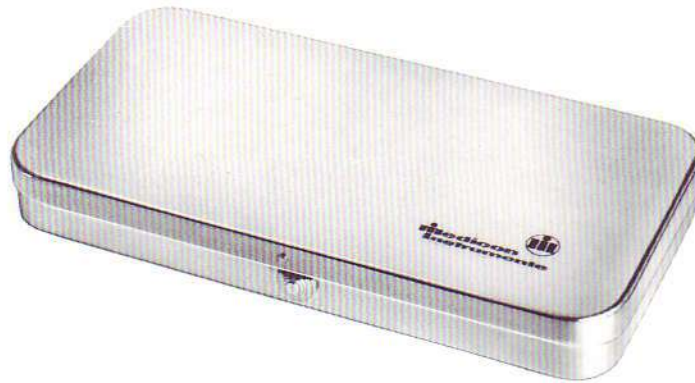

- 46.52.20** 200 x 100 x 20 mm
- 46.52.30** 200 x 100 x 30 mm
- 46.52.40** 200 x 100 x 40 mm
- 46.52.50** 200 x 100 x 50 mm

Metalletui, leer, mit Stülp-
deckel und Schieberverschluß

Metal case, empty,
with lid and slide lock

Estuche de metal, vacío, con tapa
poniéndose arriba y cierre corredizo

Boîte en métal, vide, avec
couvercle, se mettant par-dessus
et fermeture à coulisse

Scatola metallica vuota, con coperchio
sovrapposto e chiusura scorrevole



- 46.55.23** 230 x 130 x 50 mm
- 46.55.26** 260 x 150 x 50 mm
- 46.55.30** 300 x 200 x 50 mm
- 46.55.32** 325 x 275 x 50 mm

Metalletui, leer, gelocht,
mit auswechselbaren Textil-
filtern in Deckel und Boden,
Scharnierdeckel mit Hebel-
verschluss.

Metal case, empty, perforated, with
interchangeable textile filters in lid
and bottom, hinged lid with lever lock

Estuche de metal, vacío,
perforado, con filtros textiles
intercambiables en tapa y fondo,
tapa de charnela con cierre por
palanca

Boîte en métal, vide, perforée,
avec filtres en toile échangeables
dans le fond et le couvercle,
couvercle à charnière avec
fermeture à levier

Scatola metallica vuota, forata,
con filtri di stoffa intercambiabili
nel coperchio e nel fondo,
coperchio a cerniera con
chiusura a leva

Spezial-Textilfilter allein, in Packung zu 10 Stück
Special textile filters in packages of 10
Filtros textiles especiales, por paquetes de 10 piezas
Filtres spéciaux en toile, boîte de 10 pièces
Filtri di stoffa speciali soli, confezione da 10 pezzi

46.56.23 für Metalletui Nr. 46.55.23
for metal case 46.55.23
para estuche de metal No. 46.55.23
pour boîte métal No. 46.55.23
per scatola metallica 46.55.23

46.56.26 für Metalletui Nr. 46.55.26
for metal case 46.55.26
para estuche de metal No. 46.55.26
pour boîte métal No. 46.55.26
per scatola metallica 46.55.26

46.56.30 für Metalletui Nr. 46.55.30
for metal case 46.55.30
para estuche de metal No. 46.55.30
pour boîte métal No. 46.55.30
per scatola metallica 46.55.30

46.56.32 für Metalletui Nr. 46.55.32
for metal case 46.55.32
para estuche de metal No. 46.55.32
pour boîte métal No. 46.55.32
per scatola metallica 46.55.32



220 x 113 x 45 mm

Sterilisier- und Lagerungsgestell für Mikro-Instrumente mit Federgriff bis 19 cm Länge

Rack for sterilization and storage of micro-surgery instruments up to a length of 19 cm (7") with spring handles

Caballote para esterilizar y conservar micro-instrumentos con mango redondo elástico hasta 19 cm de largo

Cadre de stérilisation et de rangement, pour micro-instruments à manche faisant ressort jusqu'à 19 cm de long

Rastrelliera per sterilizzazione e conservazione per microstrumenti con manico flessibile fino a cm 19 di lunghezza

46.32.06 für 6 Instrumente
 holding 6 instruments
 para 6 instrumentos
 pour 6 instruments
 per 6 strumenti

46.32.07 für 7 Instrumente
 holding 7 instruments
 para 7 instrumentos
 pour 7 instruments
 per 7 strumenti

46.32.08 für 8 Instrumente
 holding 8 instruments
 para 8 instrumentos
 pour 8 instruments
 per 8 strumenti

MEDICONTAINER CONTAINER System



Unser komplettes Medicontainer-Programm finden Sie in unserem Sonderprospekt
For our complete Medicontainer line, see our special brochure
Nuestro programa completo de Medicontainer se encuentra en nuestro folleto especial
Vous trouverez notre programme complet des Medicontainers dans notre prospectus spécial
Il nostro programma completo di Medicontenitori lo troverete nel prospetto speciale

MEDICON CONTAINER



These complete Mediconsteril-Programs have the following advantages:
For our complete Mediconsteril line, see our special brochure.
These programs complete the Mediconsteril line and are available in several variants.
Your nearest sales program is complete for Mediconsteril and our products are sold.
If you have a complete Mediconsteril program, you will find the following advantages:

Für die freundliche Unterstützung bei der Erarbeitung von Siebvorschlägen bedanken wir uns bei Prof. Dr. med. Ulrich Lanz, Chefarzt der Klinik für Handchirurgie in Bad Neustadt a. d. Saale.

Our special thanks to Prof. Dr. med. Ulrich Lanz, Head of the Hospital for Hand Surgery in Bad Neustadt a. d. Saale, for his assistance in the elaboration of the set proposals.

Le agradecemos al Prof. Dr. med. Ulrich Lanz, Jefe de la Clínica de Cirugía de Mano en Bad Neustadt a. d. Saale por su ayuda en preparar las proposiciones de sets.

Nous faisons nos remerciements au Prof. Dr. med. Ulrich Lanz, Chef de la Clinique pour la Chirurgie de la Main, Bad Neustadt a. d. Saale, qui nous a assisté pendant l'élaboration des propositions des boîtes.

Rigraziamo sentitamente il Prof. med. Ulrich Lanz, primario della clinica di chirurgia della mano in Bad Neustadt a. d. Saale nell'aver formulato insieme a noi alcuni set di base.

Siebvorschläge für die Handchirurgie
Proposals for Hand Surgery Sets
Proposiciones para sets de Cirugía de Mano
Propositions de boîtes pour la chirurgie de la main
Proposte di set per la chirurgia della mano

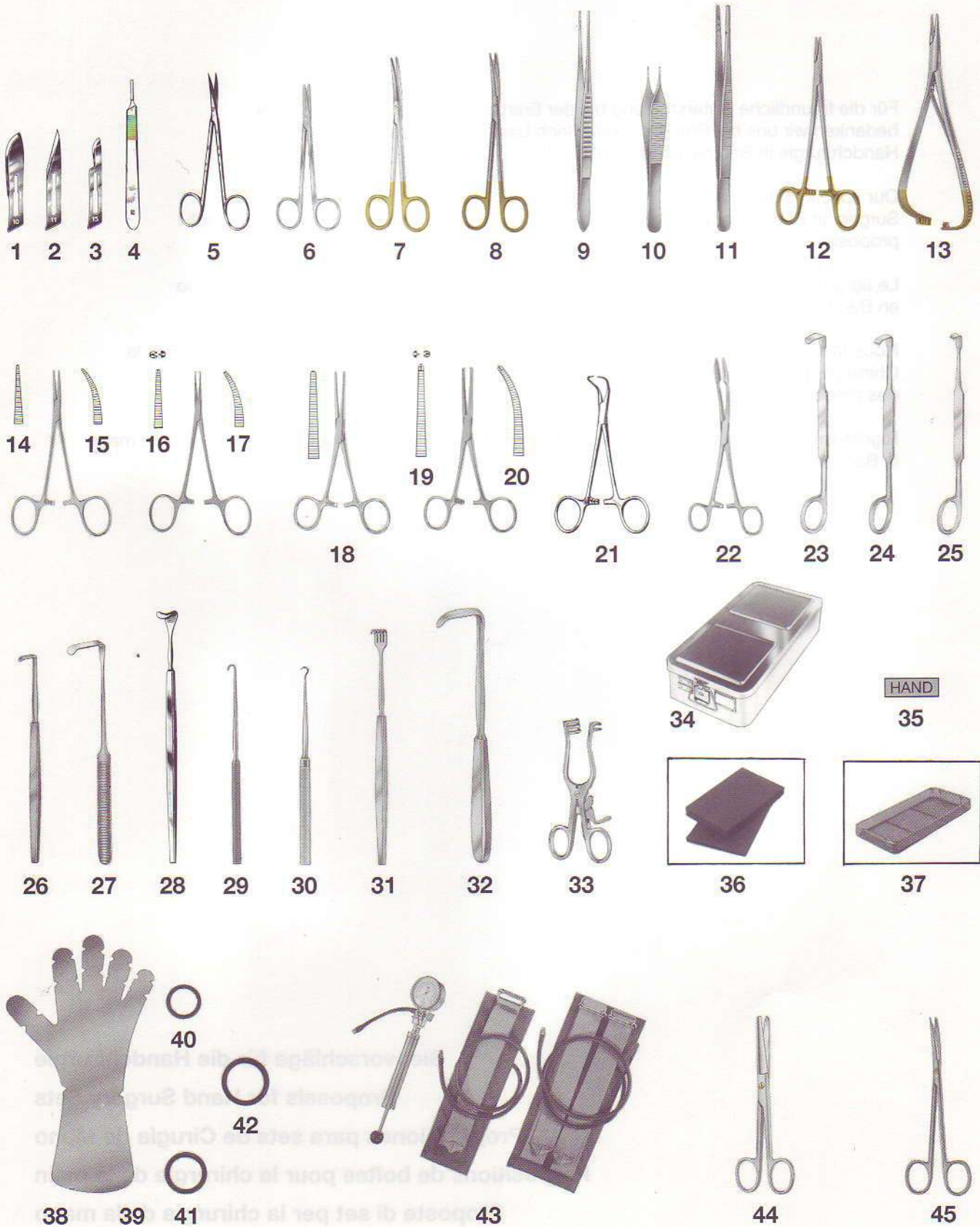

Pos. Nr. Pos. No. Pos. No. Pos. No. Pos. No.	Kat. Nr. Cat. No. Cat. No. No. Cat. No. Cat.	Verpackungseinheit Packing Unit Unidad de embalaje Unité d'emballage Unità d'imbalaggio	Abbildung: Seite Illustration: page Ilustración: página Illustration: page Illustrazione: pagina	empfohlene Stückzahl recommended quantity cantidad recomendada quantité recommandée quantità raccomandata
1	01.22.10	100	2	1
2	01.22.11	100	2	1
3	01.22.15	100	2	1
4	01.27.03	1	3	2
5	02.27.12	1	14	2
6	02.40.12	1	14	2
7	04.33.64	1	22	1
8	04.35.64	1	23	1
9	06.00.15	1	38	2
10	06.23.12	1	35	1
11	06.35.55	1	37	1
12	10.20.64	1	58	2
13	11.18.67	1	60	2
14	15.40.12	1	74	3
15	15.41.12	1	74	3
16	15.42.12	1	74	4
17	15.43.12	1	74	4
18	16.10.14	1	76	2
19	16.12.14	1	76	2
20	16.13.16	1	76	2
21	17.55.08	1	77	6
22	19.17.20	1	88	2
23	20.10.01	1	91	2
24	20.10.02	1	91	2
25	20.10.03	1	91	2
26	20.12.18	1	91	2
27	20.12.25	1	91	2
28	20.17.16	1	92	2
29	20.20.57	1	93	2
30	20.48.05	1	95	2
31	20.55.19	1	96	2
32	23.07.10	1	99	2
33	24.22.11	1	104	2
34	49.60.15	1	*	1
35	49.92.63	1	*	1
36	49.95.25	1	*	1
37	49.97.21	1	*	1
38	78.00.03	1	209	2
39	78.00.04	1	209	2
40	78.00.05	5	209	1
41	78.00.06	5	209	1
42	78.00.07	5	209	1
43	78.30.00	1	206	1
44	203.02.14	1	17	1
45	204.35.14	1	23	1

* siehe Sonderprospekt MEDICONTAINER
 * see special leaflet MEDICONTAINER
 * véase folleto especial MEDICONTAINER
 * voir prospectus spécial MEDICONTAINER
 * veda prospetto speciale MEDICONTAINER

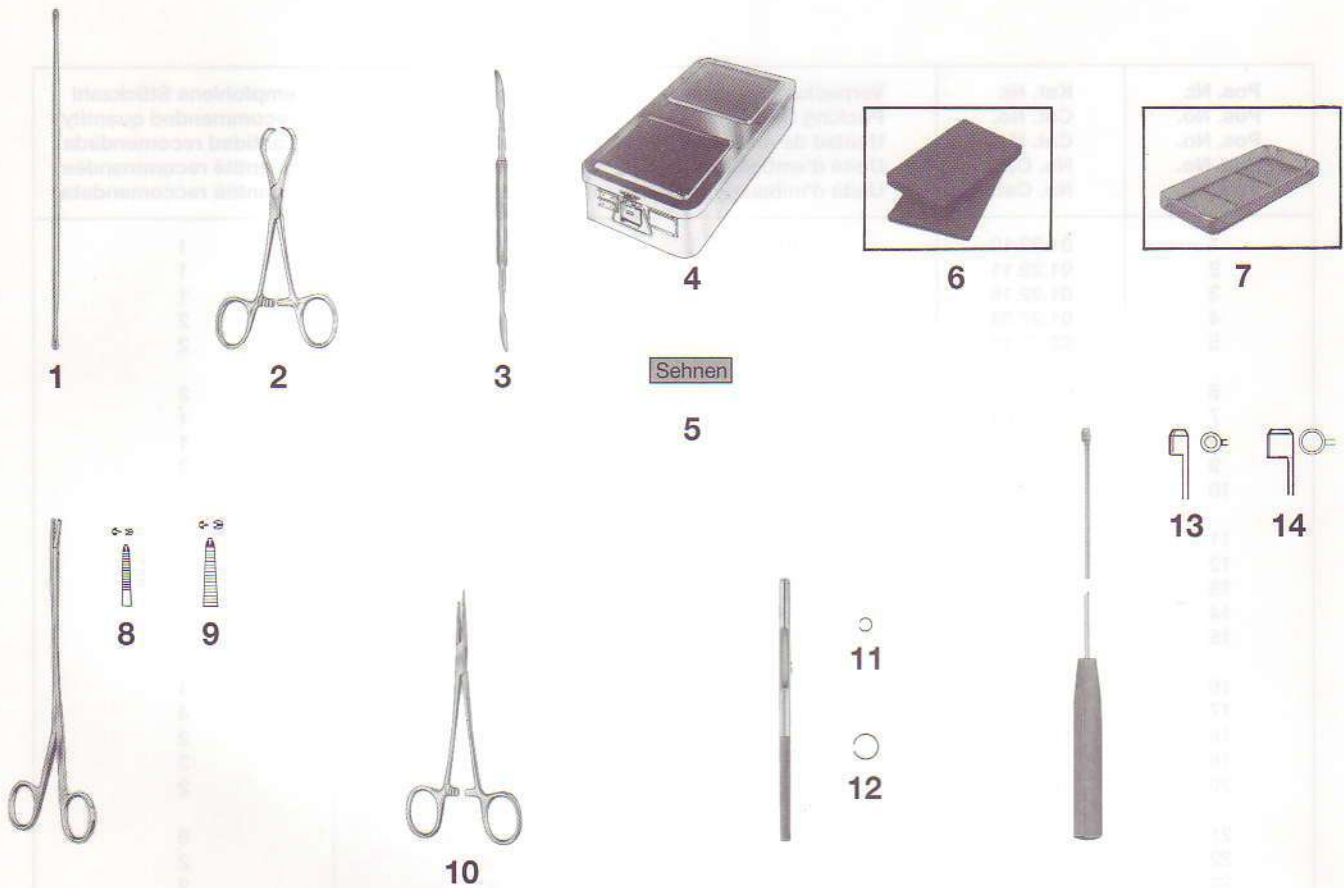

Pos. Nr. Pos. No. Pos. No. Pos. No. Pos. No.	Kat. Nr. Cat. No. Cat. No. No. Cat. No. Cat.	Verpackungseinheit Packing Unit Unidad de embalaje Unité d'emballage Unità d'imbalaggio	Abbildung: Seite Illustration: page Ilustración: página Illustration: page Illustrazione: pagina	empfohlene Stückzahl recommended quantity cantidad recomendada quantité recommandée quantità raccomandata
1	09.07.20	1	48	1
2	17.57.13	1	192	2
3	26.37.16	1	120	1
4	49.60.10	1	*	1
5	49.92.63	1	*	1
6	49.95.24	1	*	1
7	49.97.21	1	*	1
8	78.10.15	1	193	1
9	78.10.19	1	193	1
10	78.12.16	1	197	1
11	78.20.03	1	195	1
12	78.20.06	1	195	1
13	78.22.52	1	196	1
14	78.22.53	1	196	1

* siehe Sonderprospekt MEDICONTAINER
 * see special leaflet MEDICONTAINER
 * véase folleto especial MEDICONTAINER
 * voir prospectus spécial MEDICONTAINER
 * veda prospetto speciale MEDICONTAINER

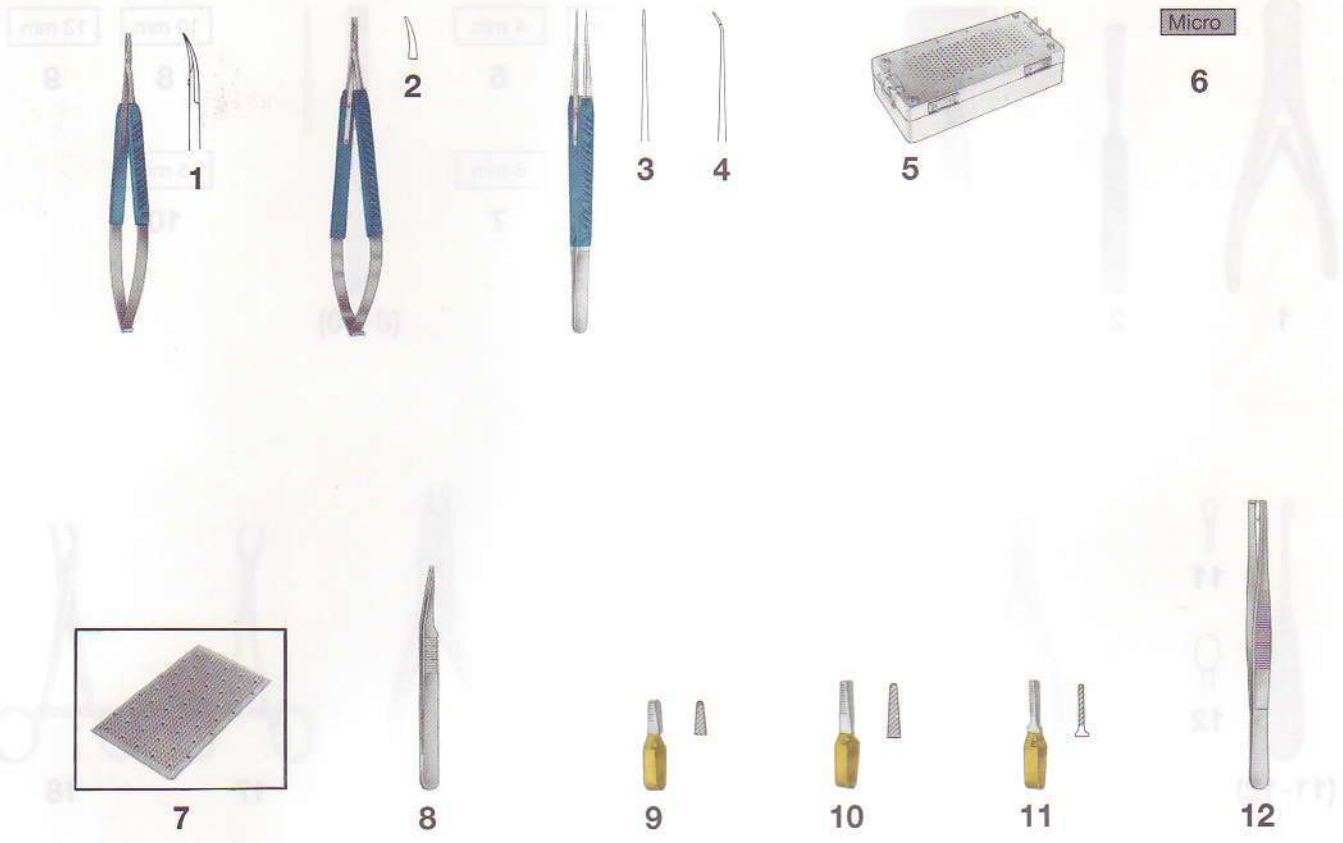

Pos. Nr. Pos. No. Pos. No. Pos. No.	Kat. Nr. Cat. No. No. Cat. No. Cat.	Verpackungseinheit Packing Unit Unidad de embalaje Unité d'emballage Unità d'imballaggio	Abbildung: Seite Illustration: page Ilustración: página Illustration: page Illustrazione: pagina	empfohlene Stückzahl recommended quantity cantidad recomendada quantité recommandée quantità raccomandata
1	05.15.73	1	30	2
2	12.15.71	1	63	2
3	13.71.42	1	67	1
4	13.71.43	1	67	1
5	49.40.60	1	*	1
6	49.92.63	1	*	1
7	49.97.71	1	*	1
8	56.60.31	1	85	1
9	56.87.05	1	82	2
10	56.87.08	1	82	2
11	56.87.18	1	82	2
12	56.87.46	1	82	1

* siehe Sonderprospekt MEDICONTAINER
 * see special leaflet MEDICONTAINER
 * véase folleto especial MEDICONTAINER
 * voir prospectus spécial MEDICONTAINER
 * veda prospetto speciale MEDICONTAINER

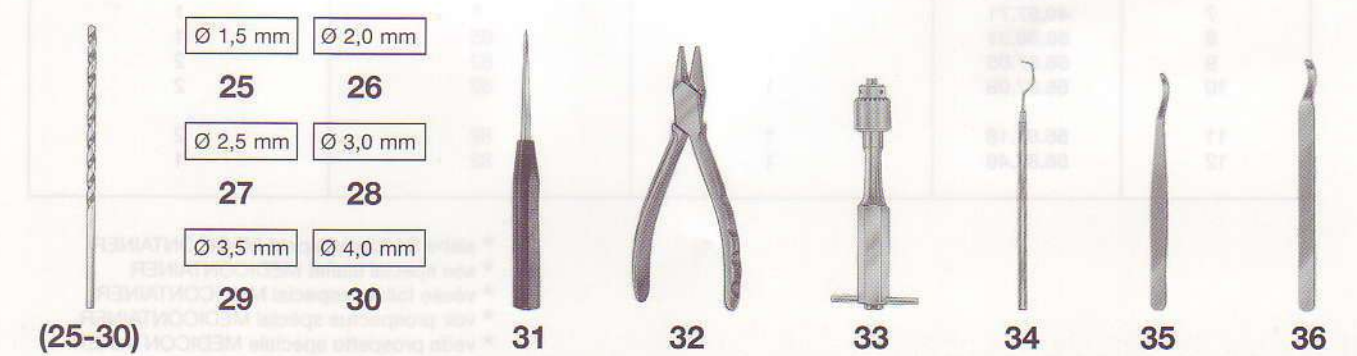
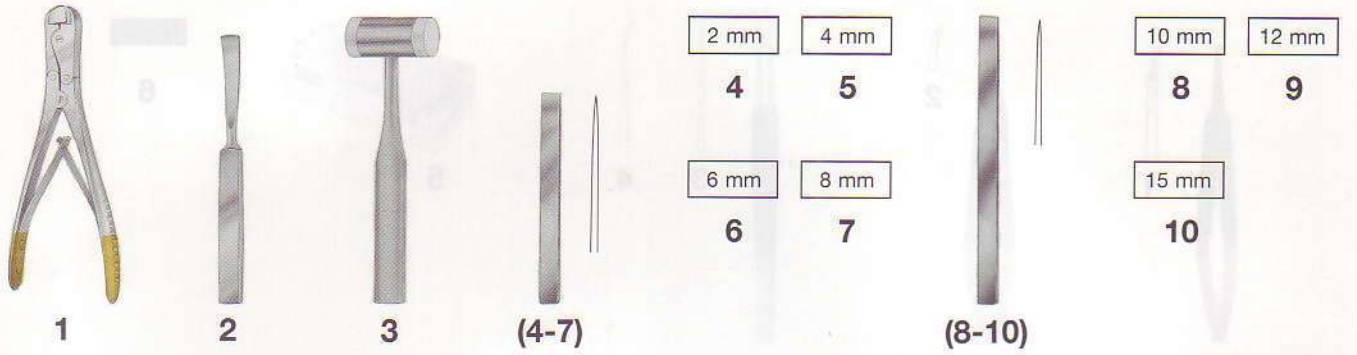

Pos. Nr. Pos. No. Pos. No. Pos. No.	Kat. Nr. Cat. No. Cat. No. No. Cat.	Verpackungseinheit Packing Unit Unidad de embalaje Unité d'emballage Unità d'imbalaggio	Abbildung: Seite Illustration: page Illustración: página Illustration: page Illustrazione: pagina	empfohlene Stückzahl recommended quantity cantidad recomendada quantité recommandée quantità raccomandata
1	14.30.17	1	158	1
2	26.60.30	1	117	1
3	27.06.20	1	122	1
4	27.57.02	1	124	1
5	27.57.04	1	124	1
6	27.57.06	1	124	1
7	27.57.08	1	124	1
8	27.57.60	1	124	1
9	27.57.62	1	124	1
10	27.57.65	1	124	1
11	29.51.24	1	135	2
12	29.51.52	1	135	2
13	30.25.30	1	138	1
14	30.52.17	1	138	1
15	31.04.02	1	140	1
16	33.51.15	1	141	1
17	35.11.12	1	142	2
18	35.14.14	1	142	1
19	35.14.16	1	142	1
20	35.35.14	1	143	1
21	49.60.13	1	*	1
22	49.92.63	1	*	1
23	49.95.25	1	*	1
24	49.97.21	1	*	1
25	76.69.15	1	171	1
26	76.69.20	1	171	1
27	76.69.25	1	171	1
28	76.69.30	1	171	1
29	76.69.35	1	171	1
30	76.69.40	1	171	1
31	78.03.02	1	174	1
32	78.03.08	1	162	1
33	78.03.10	1	167	1
34	78.29.15	1	50	1
35	78.35.03	1	176	1
36	78.35.05	1	176	1

* siehe Sonderprospekt MEDICONTAINER
 * see special leaflet MEDICONTAINER
 * véase folleto especial MEDICONTAINER
 * voir prospectus spécial MEDICONTAINER
 * veda prospetto speciale MEDICONTAINER

Zusätzliche Knochen
 Supplementary Bone Set
 Set adicional huesos
 Bone supplementaire set
 Set d'os supplémentaires



Pos. Nr. Cat. No.	Pos. Nr. Cat. No.	Pos. Nr. Cat. No.	Pos. Nr. Cat. No.	Pos. Nr. Cat. No.	Pos. Nr. Cat. No.
1	17.01.01	17.01.01	17.01.01	17.01.01	17.01.01
2	17.01.02	17.01.02	17.01.02	17.01.02	17.01.02
3	17.01.03	17.01.03	17.01.03	17.01.03	17.01.03
4	17.01.04	17.01.04	17.01.04	17.01.04	17.01.04
5	17.01.05	17.01.05	17.01.05	17.01.05	17.01.05
6	17.01.06	17.01.06	17.01.06	17.01.06	17.01.06
7	17.01.07	17.01.07	17.01.07	17.01.07	17.01.07
8	17.01.08	17.01.08	17.01.08	17.01.08	17.01.08
9	17.01.09	17.01.09	17.01.09	17.01.09	17.01.09
10	17.01.10	17.01.10	17.01.10	17.01.10	17.01.10
11	17.01.11	17.01.11	17.01.11	17.01.11	17.01.11
12	17.01.12	17.01.12	17.01.12	17.01.12	17.01.12
13	17.01.13	17.01.13	17.01.13	17.01.13	17.01.13
14	17.01.14	17.01.14	17.01.14	17.01.14	17.01.14
15	17.01.15	17.01.15	17.01.15	17.01.15	17.01.15
16	17.01.16	17.01.16	17.01.16	17.01.16	17.01.16
17	17.01.17	17.01.17	17.01.17	17.01.17	17.01.17
18	17.01.18	17.01.18	17.01.18	17.01.18	17.01.18
19	17.01.19	17.01.19	17.01.19	17.01.19	17.01.19
20	17.01.20	17.01.20	17.01.20	17.01.20	17.01.20
21	17.01.21	17.01.21	17.01.21	17.01.21	17.01.21
22	17.01.22	17.01.22	17.01.22	17.01.22	17.01.22
23	17.01.23	17.01.23	17.01.23	17.01.23	17.01.23
24	17.01.24	17.01.24	17.01.24	17.01.24	17.01.24
25	17.01.25	17.01.25	17.01.25	17.01.25	17.01.25
26	17.01.26	17.01.26	17.01.26	17.01.26	17.01.26
27	17.01.27	17.01.27	17.01.27	17.01.27	17.01.27
28	17.01.28	17.01.28	17.01.28	17.01.28	17.01.28
29	17.01.29	17.01.29	17.01.29	17.01.29	17.01.29
30	17.01.30	17.01.30	17.01.30	17.01.30	17.01.30

* vom Hersteller MEDICON
 * vom Hersteller MEDICON
 * vom Hersteller MEDICON
 * vom Hersteller MEDICON
 * vom Hersteller MEDICON

Osteosynthese Systeme
Osteosynthesis Systems
Sistemas de osteosintesis
Systemes d'osteosynthese
Sistemi per osteosintesi

**Osteosynthese Systeme für die Handchirurgie:
Bitte fordern Sie unseren Sonderprospekt an.**

**Osteosynthesis Systems for Hand Surgery:
Please ask for our special brochure.**

**Sistemas de Osteosíntesis para Cirugía de Mano:
Por favor pidannos nuestro folleto especial.**

**Systèmes d'ostéosynthèse pour la chirurgie de la main:
Veuillez commander notre prospectus spécial.**

**Sistemi Osteosintesi per la chirurgia della mano:
Vi preghiamo di richiedere il nostro prospetto speciale.**

Osteosynthese Systeme
Osteosynthesis Systems
Sistemas de osteosíntesis
Systèmes d'ostéosynthèse
Sistemi per osteosintesi

2A	01.01.70	3C	02.02.80	5S	04.03.90	7	01.02.70
3A	02.02.80	3E	03.03.90	7E	11.02.90	8	11.02.70
3B	03.03.90	3F	04.04.00	8S	01.03.90	9	01.03.70
3C	01.01.80	3G	01.01.80	9S	01.03.90	10	01.03.70
3D	01.01.80	3H	01.01.80	10S	10.03.90	11	01.03.70
3E	01.01.80	3I	01.01.80	11S	01.04.00	12	01.04.70
3F	01.01.80	3J	01.01.80	12S	01.04.00	13	01.04.70
3G	01.01.80	3K	01.01.80	13S	01.04.00	14	01.04.70
3H	01.01.80	3L	01.01.80	14S	01.04.00	15	01.04.70
3I	01.01.80	3M	01.01.80	15S	01.04.00	16	01.04.70
3J	01.01.80	3N	01.01.80	16S	01.04.00	17	01.04.70
3K	01.01.80	3O	01.01.80	17S	01.04.00	18	01.04.70
3L	01.01.80	3P	01.01.80	18S	01.04.00	19	01.04.70
3M	01.01.80	3Q	01.01.80	19S	01.04.00	20	01.04.70
3N	01.01.80	3R	01.01.80	20S	01.04.00	21	01.04.70
3O	01.01.80	3S	01.01.80	21S	01.04.00	22	01.04.70
3P	01.01.80	3T	01.01.80	22S	01.04.00	23	01.04.70
3Q	01.01.80	3U	01.01.80	23S	01.04.00	24	01.04.70
3R	01.01.80	3V	01.01.80	24S	01.04.00	25	01.04.70
3S	01.01.80	3W	01.01.80	25S	01.04.00	26	01.04.70
3T	01.01.80	3X	01.01.80	26S	01.04.00	27	01.04.70
3U	01.01.80	3Y	01.01.80	27S	01.04.00	28	01.04.70
3V	01.01.80	3Z	01.01.80	28S	01.04.00	29	01.04.70
3W	01.01.80	4A	01.01.80	29S	01.04.00	30	01.04.70
3X	01.01.80	4B	01.01.80	30S	01.04.00	31	01.04.70
3Y	01.01.80	4C	01.01.80	31S	01.04.00	32	01.04.70
3Z	01.01.80	4D	01.01.80	32S	01.04.00	33	01.04.70
4A	01.01.80	4E	01.01.80	33S	01.04.00	34	01.04.70
4B	01.01.80	4F	01.01.80	34S	01.04.00	35	01.04.70
4C	01.01.80	4G	01.01.80	35S	01.04.00	36	01.04.70
4D	01.01.80	4H	01.01.80	36S	01.04.00	37	01.04.70
4E	01.01.80	4I	01.01.80	37S	01.04.00	38	01.04.70
4F	01.01.80	4J	01.01.80	38S	01.04.00	39	01.04.70
4G	01.01.80	4K	01.01.80	39S	01.04.00	40	01.04.70
4H	01.01.80	4L	01.01.80	40S	01.04.00	41	01.04.70
4I	01.01.80	4M	01.01.80	41S	01.04.00	42	01.04.70
4J	01.01.80	4N	01.01.80	42S	01.04.00	43	01.04.70
4K	01.01.80	4O	01.01.80	43S	01.04.00	44	01.04.70
4L	01.01.80	4P	01.01.80	44S	01.04.00	45	01.04.70
4M	01.01.80	4Q	01.01.80	45S	01.04.00	46	01.04.70
4N	01.01.80	4R	01.01.80	46S	01.04.00	47	01.04.70
4O	01.01.80	4S	01.01.80	47S	01.04.00	48	01.04.70
4P	01.01.80	4T	01.01.80	48S	01.04.00	49	01.04.70
4Q	01.01.80	4U	01.01.80	49S	01.04.00	50	01.04.70
4R	01.01.80	4V	01.01.80	50S	01.04.00	51	01.04.70
4S	01.01.80	4W	01.01.80	51S	01.04.00	52	01.04.70
4T	01.01.80	4X	01.01.80	52S	01.04.00	53	01.04.70
4U	01.01.80	4Y	01.01.80	53S	01.04.00	54	01.04.70
4V	01.01.80	4Z	01.01.80	54S	01.04.00	55	01.04.70
4W	01.01.80	5A	01.01.80	55S	01.04.00	56	01.04.70
4X	01.01.80	5B	01.01.80	56S	01.04.00	57	01.04.70
4Y	01.01.80	5C	01.01.80	57S	01.04.00	58	01.04.70
4Z	01.01.80	5D	01.01.80	58S	01.04.00	59	01.04.70
5A	01.01.80	5E	01.01.80	59S	01.04.00	60	01.04.70
5B	01.01.80	5F	01.01.80	60S	01.04.00	61	01.04.70
5C	01.01.80	5G	01.01.80	61S	01.04.00	62	01.04.70
5D	01.01.80	5H	01.01.80	62S	01.04.00	63	01.04.70
5E	01.01.80	5I	01.01.80	63S	01.04.00	64	01.04.70
5F	01.01.80	5J	01.01.80	64S	01.04.00	65	01.04.70
5G	01.01.80	5K	01.01.80	65S	01.04.00	66	01.04.70
5H	01.01.80	5L	01.01.80	66S	01.04.00	67	01.04.70
5I	01.01.80	5M	01.01.80	67S	01.04.00	68	01.04.70
5J	01.01.80	5N	01.01.80	68S	01.04.00	69	01.04.70
5K	01.01.80	5O	01.01.80	69S	01.04.00	70	01.04.70
5L	01.01.80	5P	01.01.80	70S	01.04.00	71	01.04.70
5M	01.01.80	5Q	01.01.80	71S	01.04.00	72	01.04.70
5N	01.01.80	5R	01.01.80	72S	01.04.00	73	01.04.70
5O	01.01.80	5S	01.01.80	73S	01.04.00	74	01.04.70
5P	01.01.80	5T	01.01.80	74S	01.04.00	75	01.04.70
5Q	01.01.80	5U	01.01.80	75S	01.04.00	76	01.04.70
5R	01.01.80	5V	01.01.80	76S	01.04.00	77	01.04.70
5S	01.01.80	5W	01.01.80	77S	01.04.00	78	01.04.70
5T	01.01.80	5X	01.01.80	78S	01.04.00	79	01.04.70
5U	01.01.80	5Y	01.01.80	79S	01.04.00	80	01.04.70
5V	01.01.80	5Z	01.01.80	80S	01.04.00	81	01.04.70
5W	01.01.80	6A	01.01.80	81S	01.04.00	82	01.04.70
5X	01.01.80	6B	01.01.80	82S	01.04.00	83	01.04.70
5Y	01.01.80	6C	01.01.80	83S	01.04.00	84	01.04.70
5Z	01.01.80	6D	01.01.80	84S	01.04.00	85	01.04.70
6A	01.01.80	6E	01.01.80	85S	01.04.00	86	01.04.70
6B	01.01.80	6F	01.01.80	86S	01.04.00	87	01.04.70
6C	01.01.80	6G	01.01.80	87S	01.04.00	88	01.04.70
6D	01.01.80	6H	01.01.80	88S	01.04.00	89	01.04.70
6E	01.01.80	6I	01.01.80	89S	01.04.00	90	01.04.70
6F	01.01.80	6J	01.01.80	90S	01.04.00	91	01.04.70
6G	01.01.80	6K	01.01.80	91S	01.04.00	92	01.04.70
6H	01.01.80	6L	01.01.80	92S	01.04.00	93	01.04.70
6I	01.01.80	6M	01.01.80	93S	01.04.00	94	01.04.70
6J	01.01.80	6N	01.01.80	94S	01.04.00	95	01.04.70
6K	01.01.80	6O	01.01.80	95S	01.04.00	96	01.04.70
6L	01.01.80	6P	01.01.80	96S	01.04.00	97	01.04.70
6M	01.01.80	6Q	01.01.80	97S	01.04.00	98	01.04.70
6N	01.01.80	6R	01.01.80	98S	01.04.00	99	01.04.70
6O	01.01.80	6S	01.01.80	99S	01.04.00	100	01.04.70

**Numerisches Inhaltsverzeichnis
Numerical Index
Indice numérico
Table des matières numérique
Indice numerico**



01.22.10	2	04.32.64	22	06.30.22	36	07.70.18	45
01.22.11	2	04.33.11	21	06.30.25	36	09.07.20	48
01.22.12	2	04.33.14	22	06.30.30	36	09.08.24	48
01.22.13	2	04.33.15	24	06.31.10	36	09.12.13	48
01.22.15	2	04.33.61	21	06.31.12	36	09.12.14	48
01.27.03	3	04.33.64	22	06.31.15	36	09.12.15	48
01.27.07	3	04.34.14	23	06.31.20	36	09.12.18	48
01.27.17	3	04.34.64	23	06.31.22	36	09.12.20	48
01.27.40	3	04.35.14	23	06.31.25	36	09.15.13	48
01.94.19	8	04.35.64	23	06.31.30	36	09.15.14	48
02.06.10	10	04.50.15	16	06.34.51	37	09.16.13	48
02.06.12	10	04.51.15	16	06.34.53	37	09.16.14	48
02.06.13	11	04.63.15	24	06.34.55	37	09.81.42	52
02.07.02	11	04.65.15	25	06.35.51	37	09.81.43	52
02.07.10	10	04.66.12	26	06.35.53	37	09.83.06	52
02.07.12	10	04.66.14	26	06.35.55	37	09.83.08	52
02.07.13	11	04.66.16	26	06.40.15	37	09.83.10	52
02.07.80	11	04.67.12	26	06.40.85	37	09.85.08	52
02.10.10	12	04.67.13	25	06.50.15	38	10.00.11	54
02.10.12	12	04.67.14	26	06.59.15	38	10.00.12	54
02.11.10	12	04.67.15	25	06.60.68	39	10.00.62	54
02.11.12	12	04.67.16	26	06.60.69	39	10.08.11	54
02.20.09	12	04.83.16	28	06.60.90	39	10.08.12	56
02.20.30	12	05.12.20	29	06.60.91	39	10.08.14	54
02.20.42	13	05.12.21	29	06.83.15	39	10.08.15	55
02.20.43	13	05.12.25	29	06.83.85	39	10.08.17	54
02.20.61	13	05.12.30	29	07.00.10	40	10.08.18	55
02.21.09	12	05.12.31	29	07.00.30	40	10.08.62	56
02.21.30	12	05.15.20	29	07.01.10	40	10.08.65	55
02.21.42	13	05.15.21	29	07.01.30	40	10.10.12	56
02.21.43	13	05.15.70	30	07.04.05	40	10.10.13	56
02.21.61	13	05.15.71	30	07.04.10	40	10.10.62	56
02.26.12	14	05.15.72	30	07.60.03	41	10.10.63	56
02.27.12	14	05.15.73	30	07.60.04	41	10.12.12	57
02.40.12	14	05.15.74	31	07.60.05	41	10.12.62	57
02.50.02	14	05.15.75	31	07.60.07	41	10.12.82	57
02.50.03	14	05.15.76	31	07.61.05	41	10.15.13	57
02.50.12	15	05.15.77	31	07.61.06	41	10.18.15	57
02.50.13	15	05.15.81	30	07.61.07	41	10.18.65	57
02.50.43	15	05.15.83	30	07.61.08	41	10.20.14	58
02.50.45	15	05.18.20	29	07.61.11	42	10.20.15	58
02.50.52	15	05.18.21	29	07.61.12	42	10.20.64	58
03.02.14	17	05.18.70	30	07.61.13	42	10.20.65	58
03.02.64	17	05.18.71	30	07.61.14	42	10.26.63	58
03.03.14	17	06.00.15	38	07.61.25	42	10.26.65	58
03.03.64	17	06.02.65	38	07.61.26	42	10.28.63	58
03.06.13	18	06.07.14	38	07.61.27	42	10.28.64	58
03.06.14	18	06.20.12	34	07.61.28	42	10.28.65	58
03.06.64	18	06.20.62	34	07.63.01	43	10.28.66	58
03.07.13	18	06.20.65	34	07.63.02	43	10.39.17	59
03.07.14	18	06.21.12	34	07.63.25	43	10.60.13	59
03.07.64	18	06.21.13	34	07.63.31	43	10.60.14	59
03.22.13	190	06.21.15	34	07.63.32	43	10.60.63	59
03.22.15	190	06.21.62	34	07.64.03	44	10.60.64	59
04.13.12	19	06.22.12	35	07.64.04	44	11.18.17	60
04.13.13	19	06.22.15	35	07.64.13	44	11.18.67	60
04.13.15	19	06.23.12	35	07.64.14	44	11.50.12	60
04.13.20	19	06.23.15	35	07.64.63	44	11.50.16	60
04.24.14	20	06.25.12	35	07.64.64	44	11.50.62	60
04.24.64	20	06.25.72	35	07.64.73	44	11.50.66	60
04.25.14	20	06.25.82	35	07.64.74	44	11.62.34	61
04.25.64	20	06.30.10	36	07.66.12	45	11.62.37	61
04.32.11	21	06.30.12	36	07.66.15	45	11.62.64	61
04.32.14	22	06.30.15	36	07.70.11	45	11.62.67	61
04.32.61	21	06.30.20	36	07.70.15	45	11.62.84	61

11.62.87	61	14.30.11	158	17.06.14	77	20.40.15	94
11.74.23	61	14.30.13	158	17.55.08	77	20.40.16	95
11.74.25	61	14.30.17	158	17.55.10	77	20.45.14	95
11.82.18	61	14.30.28	159	17.55.13	77	20.45.16	95
11.82.68	61	14.30.65	159	17.55.20	77	20.48.03	95
12.12.40	62	14.30.76	159	17.55.23	77	20.48.05	95
12.12.41	62	14.40.15	161	17.57.13	192	20.48.07	95
12.12.42	62	14.40.65	161	19.16.20	88	20.50.01	95
12.12.43	62	14.44.17	161	19.16.26	88	20.50.02	95
12.12.48	62	14.44.67	161	19.17.20	88	20.50.05	95
12.12.54	64	14.46.14	161	19.17.26	88	20.50.07	95
12.12.55	64	14.48.05	161	19.40.18	88	20.50.10	95
12.12.59	64	14.48.07	161	19.41.18	88	20.52.02	96
12.15.30	62	15.10.08	72	20.05.08	90	20.52.10	96
12.15.31	62	15.10.12	72	20.05.09	90	20.52.11	96
12.15.32	62	15.10.16	72	20.05.12	90	20.53.50	96
12.15.33	62	15.10.38	73	20.05.13	90	20.55.13	96
12.15.50	62	15.10.51	73	20.05.25	90	20.55.16	96
12.15.51	62	15.11.08	72	20.05.50	90	20.55.17	96
12.15.70	63	15.11.12	72	20.07.07	90	20.55.19	96
12.15.71	63	15.11.16	72	20.07.08	90	20.55.33	96
12.15.72	63	15.11.38	73	20.09.11	90	20.55.43	96
12.15.73	63	15.11.51	73	20.09.50	91	20.60.01	97
12.15.76	64	15.15.38	73	20.10.01	91	20.60.02	97
12.15.77	64	15.15.51	73	20.10.02	91	20.60.03	97
12.18.70	63	15.16.07	73	20.10.03	91	20.60.04	97
12.18.71	63	15.17.07	73	20.10.04	91	20.61.01	97
12.18.72	63	15.30.09	74	20.10.05	91	20.61.02	97
12.18.73	63	15.31.09	74	20.10.06	91	20.61.03	97
12.18.76	64	15.32.09	74	20.12.10	91	20.61.04	97
12.18.77	64	15.33.09	74	20.12.18	91	20.64.01	97
12.18.80	64	15.34.09	74	20.12.20	91	20.64.02	97
12.18.81	64	15.35.09	74	20.12.25	91	20.64.03	97
13.11.10	65	15.40.12	74	20.12.26	91	20.64.04	97
13.11.12	65	15.40.82	74	20.12.75	92	20.64.52	98
13.11.13	65	15.41.12	74	20.12.85	92	20.64.53	98
13.11.17	65	15.41.82	74	20.15.13	92	20.65.01	97
13.12.24	65	15.42.12	74	20.15.16	92	20.65.02	97
13.12.25	65	15.43.12	74	20.15.33	92	20.65.03	97
13.13.02	66	15.44.12	75	20.15.36	92	20.65.04	97
13.32.03	66	15.44.13	75	20.17.16	92	20.65.52	98
13.32.05	66	15.44.42	75	20.17.50	92	20.65.53	98
13.32.07	66	15.45.12	75	20.17.80	92	20.65.75	98
13.70.10	67	15.45.42	75	20.17.81	92	20.66.01	98
13.70.11	67	15.50.14	75	20.20.12	93	20.66.02	98
13.70.20	67	15.51.14	75	20.20.17	93	20.66.03	98
13.70.21	67	15.56.15	75	20.20.18	93	20.66.04	98
13.70.42	67	15.57.15	75	20.20.34	93	20.67.01	98
13.70.72	67	15.58.15	75	20.20.57	93	20.67.02	98
13.70.74	67	15.59.15	75	20.20.59	93	20.67.03	98
13.71.22	67	15.70.14	75	20.22.01	93	20.67.04	98
13.71.23	67	15.71.14	75	20.22.02	93	23.07.10	99
13.71.42	67	16.10.13	76	20.22.03	93	24.04.05	102
13.71.43	67	16.10.14	76	20.22.31	93	24.04.06	102
14.06.09	69	16.10.16	76	20.22.32	93	24.04.07	102
14.06.10	69	16.11.13	76	20.22.36	93	24.04.08	102
14.06.12	69	16.11.14	76	20.22.37	93	24.04.18	102
14.06.13	69	16.11.16	76	20.30.12	94	24.05.57	102
14.09.84	156	16.12.13	76	20.30.19	94	24.05.58	102
14.20.09	156	16.12.14	76	20.30.20	94	24.06.00	102
14.23.12	156	16.12.16	76	20.31.13	94	24.06.01	102, 103
14.23.62	156	16.13.13	76	20.31.15	94	24.06.02	103
14.26.10	157	16.13.14	76	20.35.01	94	24.07.00	102
14.28.68	157	16.13.16	76	20.35.02	94	24.08.00	102
14.29.68	157	17.05.14	77	20.35.32	94	24.09.00	103

24.09.09	103	27.57.02	124	27.90.04	128	29.67.33	135
24.09.10	103	27.57.04	124	27.90.05	128	29.67.42	135
24.10.07	103	27.57.06	124	27.95.03	129	29.67.50	135
24.10.10	103	27.57.08	124	27.95.05	129	29.67.51	135
24.10.55	103	27.57.10	124	27.95.07	129	29.67.52	135
24.10.60	103	27.57.12	124	27.95.09	129	29.80.10	136
24.10.70	103	27.57.15	124	28.41.04	128	29.80.11	136
24.22.10	104	27.57.52	124	28.41.06	128	29.80.12	136
24.22.11	104	27.57.54	124	28.41.08	128	29.83.10	136
24.22.13	104	27.57.56	124	28.41.10	128	29.83.11	136
24.22.14	104	27.57.58	124	28.41.12	128	29.83.12	136
26.01.11	106	27.57.60	124	28.41.15	128	29.83.50	136
26.05.13	107	27.57.62	124	28.42.06	128	29.83.62	136
26.05.22	106	27.57.65	124	28.42.08	128	29.87.11	136
26.05.41	107	27.57.90	124	28.42.10	128	30.05.14	138
26.05.42	107	27.57.95	124	28.42.12	128	30.25.30	138
26.05.43	107	27.58.02	125	28.42.15	128	30.52.17	138
26.10.12	106	27.58.04	125	28.61.02	129	30.71.02	138
26.10.22	106	27.58.06	125	28.61.04	129	30.71.03	138
26.23.04	112	27.58.08	125	28.61.06	129	30.75.14	138
26.24.04	112	27.58.10	125	28.61.08	129	30.76.13	139
26.24.05	112	27.58.12	125	28.61.10	129	30.76.14	139
26.24.07	112	27.58.15	125	28.61.12	129	30.76.16	139
26.35.02	112	27.58.52	125	28.61.15	129	30.76.17	139
26.35.03	112	27.58.54	125	28.61.20	129	30.76.18	139
26.37.01	114	27.58.56	125	28.62.02	129	30.76.19	139
26.37.02	114	27.58.58	125	28.62.04	129	30.76.26	139
26.37.03	114	27.58.60	125	28.62.06	129	30.76.29	139
26.37.07	114	27.58.62	125	28.62.08	129	31.04.02	140
26.37.16	120	27.58.65	125	28.62.10	129	31.04.03	140
26.37.90	120	27.58.90	125	28.62.12	129	31.05.02	140
26.39.09	120	27.58.95	125	28.62.15	129	31.05.03	140
26.42.03	115	27.59.72	126	28.62.20	129	31.05.53	140
26.42.05	115	27.59.74	126	29.48.02	134	31.11.04	140
26.42.07	115	27.59.76	126	29.48.03	134	31.11.05	140
26.42.14	115	27.59.78	126	29.48.04	134	33.02.15	141
26.42.15	115	27.59.80	126	29.48.05	134	33.11.14	141
26.42.24	115	27.62.02	126	29.48.06	134	33.47.70	141
26.42.25	115	27.62.04	126	29.48.07	134	33.50.15	141
26.42.34	115	27.62.06	126	29.48.08	134	33.51.15	141
26.42.64	116	27.62.08	126	29.49.02	134	33.51.35	141
26.44.04	116	27.62.10	126	29.49.03	134	33.57.18	141
26.44.22	116	27.62.12	126	29.49.04	134	33.58.18	141
26.44.23	116	27.62.15	126	29.49.05	134	33.59.18	141
26.44.24	116	27.62.18	126	29.49.06	134	35.11.12	142
26.44.25	116	27.62.62	127	29.49.07	134	35.11.13	142
26.44.28	116	27.62.63	127	29.49.08	134	35.11.14	142
26.45.04	116	27.62.64	127	29.51.24	135	35.11.16	142
26.45.07	116	27.62.66	127	29.51.33	135	35.14.14	142
26.45.09	116	27.64.04	127	29.51.42	135	35.14.16	142
26.45.12	116	27.64.07	127	29.51.50	135	35.15.18	143
26.50.09	116	27.64.09	127	29.51.51	135	35.15.19	143
26.50.70	117	27.64.12	127	29.51.52	135	35.20.20	143
26.60.30	117	27.68.03	127	29.51.53	135	35.35.14	143
26.64.06	117	27.68.05	127	29.51.54	135	35.35.23	143
26.64.13	117	27.68.14	127	29.51.55	135	35.45.23	144
26.64.16	117	27.80.10	128	29.51.56	135	35.45.73	144
26.64.26	117	27.80.11	128	29.63.33	135	35.75.17	144
27.02.10	122	27.80.19	128	29.63.42	135	40.25.14	222
27.02.13	122	27.82.12	128	29.63.50	135	40.25.18	222
27.04.20	122	27.82.14	128	29.63.51	135	40.25.20	222
27.04.90	122	27.82.15	128	29.63.52	135	40.25.96	222
27.06.20	122	27.90.01	128	29.67.06	135	40.50.63	224, 225
27.06.21	122	27.90.02	128	29.67.15	135	40.50.64	224, 225
27.10.31	122	27.90.03	128	29.67.24	135	40.50.65	226

40.50.66	226	56.85.34	80	60.47.09	68	67.60.60	109
40.50.68	226	56.85.37	80	60.47.15	68	67.60.61	109
40.50.69	226	56.85.48	80	60.47.51	68	67.60.62	109
40.50.71	226	56.85.51	80	60.47.53	68	67.60.63	109
40.50.72	226	56.85.54	80	60.47.55	68	67.60.64	109
40.50.73	226	56.85.57	80	60.47.59	68	67.90.05	220
40.50.74	226	56.85.68	80	60.47.65	68	68.02.24	118
40.55.20	223	56.85.71	80	60.70.05	31	68.02.25	118
40.81.18	223	56.85.74	80	60.70.25	31	68.02.26	118
43.40.00	188	56.85.77	80	60.70.35	31	68.03.02	129
43.40.10	188	56.85.91	81	60.70.45	31	68.03.04	129
43.40.50	188	56.85.93	81	60.73.30	32	68.04.81	160
43.40.60	188	56.85.98	81	60.73.31	32	68.04.82	160
43.45.00	185	56.87.05	82	60.73.57	32	68.04.85	162
43.45.01	185	56.87.08	82	60.74.01	32	68.04.86	162
43.46.00	185	56.87.18	82	60.74.03	32	68.04.87	162
43.46.01	185	56.87.30	83	60.75.31	32	68.04.88	162
43.48.15	189	56.87.35	83	62.22.10	52	68.04.90	161
43.49.01	104	56.87.38	82	62.22.15	52	68.24.00	178
43.49.02	104	56.87.46	82	62.22.20	52	68.24.05	180
43.62.10	190	56.87.47	83	62.60.10	120	68.24.10	182
43.63.10	190	56.87.49	82	62.90.18	212	68.24.12	183
43.75.14	189	58.30.17	118	62.90.25	212	68.24.13	183
43.78.11	189	58.54.60	84	62.90.30	213	68.24.14	183
43.78.13	189	58.54.96	85	62.90.49	213	68.24.15	183
44.33.20	218	58.54.97	85	62.90.68	214	68.24.16	183
44.35.15	218	58.55.60	84	62.90.80	215	68.24.19	178, 180, 182, 183
44.36.20	218	58.55.80	84	66.53.01	112	68.24.20	178, 180, 182
44.37.15	218	58.56.58	84	66.53.02	112	68.24.21	183
44.37.20	218	58.56.96	85	66.54.30	113	68.24.22	183
44.37.30	218	58.56.97	85	66.54.90	50	68.24.24	179
44.37.50	218	58.57.58	84	66.54.91	50	68.24.25	179
44.38.05	219	58.57.68	84	67.14.30	6	68.24.26	179
44.38.30	219	59.16.20	31	67.14.31	6	68.24.27	179
46.32.06	230	59.16.21	31	67.14.50	7	68.24.28	179
46.32.07	230	59.18.10	45	67.14.51	7	68.24.29	179
46.32.08	230	59.18.14	45	67.14.52	7	68.24.30	179
46.52.20	228	60.00.30	219	67.16.12	113	68.24.31	179
46.52.30	228	60.00.40	220	67.16.13	113	68.24.35	181
46.52.40	228	60.05.10	99	67.16.14	113	68.24.36	181
46.52.50	228	60.05.11	99	67.16.23	113	68.24.37	181
46.55.23	229	60.05.12	99	67.20.03	100	68.24.40	166
46.55.26	229	60.05.13	99	67.20.23	100	75.51.61	170
46.55.30	229	60.05.14	99	67.20.25	100	75.70.02	146
46.55.32	229	60.22.02	99	67.50.01	16	75.70.03	146
46.56.23	229	60.22.03	99	67.51.14	16	75.70.04	146
46.56.26	229	60.22.51	99	67.52.12	16	75.70.05	146
46.56.30	229	60.22.52	99	67.58.13	40	75.70.06	146
46.56.32	229	60.22.53	99	67.58.15	40	75.70.07	146
49.40.35	132	60.34.10	49	67.58.33	40	75.70.08	146
49.92.57	132	60.34.11	49	67.58.35	40	75.70.09	146
49.97.71	132	60.34.12	49	67.58.43	40	75.70.10	146
50.02.13	200	60.34.14	49	67.59.25	107	75.70.12	146
50.02.14	200	60.34.16	49	67.59.36	107	75.70.13	146
50.02.15	200	60.34.18	49	67.59.50	107	75.70.14	146
50.02.16	200	60.34.31	49	67.59.65	106	75.70.15	146
50.03.16	192, 200	60.34.32	49	67.59.70	106	75.70.16	146
54.17.67	144	60.34.34	49	67.59.71	107	75.70.17	146
56.60.31	85	60.34.36	49	67.60.10	184	75.70.19	146
56.85.08	80	60.34.38	49	67.60.51	108	75.70.20	146
56.85.11	80	60.45.23	68	67.60.52	108	75.70.21	146
56.85.14	80	60.45.28	68	67.60.53	108	75.70.22	146
56.85.17	80	60.47.01	68	67.60.54	108	75.70.54	146
56.85.28	80	60.47.03	68	67.60.55	108	75.70.56	146
56.85.31	80	60.47.05	68	67.60.56	108	75.70.57	146



75.70.59	146	76.07.14	151	76.10.68	152	78.10.19	193
75.74.22	147	76.07.15	151	76.10.69	152	78.10.25	193
75.74.52	147	76.07.16	151	76.10.70	152	78.11.15	193
76.01.02	150	76.07.17	151	76.10.72	152	78.11.19	193
76.01.03	150	76.07.18	151	76.10.75	152	78.11.25	193
76.01.04	150	76.07.19	151	76.10.78	153	78.12.13	192
76.01.05	150	76.07.20	151	76.10.79	153	78.12.15	197
76.01.06	150	76.07.22	151	76.10.80	153	78.12.16	197
76.01.07	150	76.07.25	151	76.10.81	153	78.14.20	193
76.01.08	150	76.07.58	152	76.10.82	153	78.14.21	193
76.01.09	150	76.07.59	152	76.10.83	153	78.14.40	193
76.01.10	150	76.07.60	152	76.10.84	153	78.14.42	193
76.01.12	150	76.07.61	152	76.10.85	153	78.15.02	192
76.01.15	150	76.07.62	152	76.10.86	153	78.15.03	192
76.06.08	151	76.07.63	152	76.10.87	153	78.15.04	192
76.06.09	151	76.07.64	152	76.10.88	153	78.15.05	192
76.06.10	151	76.07.65	152	76.10.89	153	78.20.02	195
76.06.11	151	76.07.66	152	76.10.90	153	78.20.03	195
76.06.12	151	76.07.67	152	76.10.92	153	78.20.04	195
76.06.13	151	76.07.68	152	76.10.95	153	78.20.06	195
76.06.14	151	76.07.69	152	76.16.00	154	78.20.54	195
76.06.15	151	76.07.70	152	76.16.01	154	78.20.55	195
76.06.16	151	76.07.72	152	76.51.10	168	78.20.56	195
76.06.17	151	76.07.75	152	76.51.11	167, 168	78.22.30	195
76.06.18	151	76.07.78	153	76.51.20	169	78.22.50	195
76.06.19	151	76.07.79	153	76.51.21	169	78.22.51	195
76.06.20	151	76.07.80	153	76.51.60	170	78.22.52	196
76.06.22	151	76.07.81	153	76.51.61	170	78.22.53	196
76.06.25	151	76.07.82	153	76.55.17	171	78.23.50	196
76.06.58	152	76.07.83	153	76.59.21	174	78.26.10	194
76.06.59	152	76.07.84	153	76.59.22	174	78.26.12	194
76.06.60	152	76.07.85	153	76.69.15	171	78.26.58	194
76.06.61	152	76.07.86	153	76.69.20	171	78.26.63	194
76.06.62	152	76.07.87	153	76.69.25	171	78.26.80	194
76.06.63	152	76.07.88	153	76.69.30	171	78.26.81	194
76.06.64	152	76.07.89	153	76.69.32	171	78.28.12	196
76.06.65	152	76.07.90	153	76.69.35	171	78.28.13	196
76.06.66	152	76.07.92	153	76.69.40	171	78.28.14	196
76.06.67	152	76.07.95	153	76.69.45	171	78.28.43	196
76.06.68	152	76.10.00	154	76.69.50	171	78.29.14	50
76.06.69	152	76.10.08	151	76.69.60	171	78.29.15	50
76.06.70	152	76.10.09	151	77.02.14	184	78.30.00	206
76.06.72	152	76.10.10	151	77.02.23	184	78.35.03	176
76.06.75	152	76.10.11	151	77.55.13	28	78.35.05	176
76.06.78	153	76.10.12	151	77.55.20	28	78.35.07	176
76.06.79	153	76.10.13	151	78.00.01	208	78.35.09	176
76.06.80	153	76.10.14	151	78.00.02	208	78.35.11	176
76.06.81	153	76.10.15	151	78.00.03	209	78.35.55	176
76.06.82	153	76.10.16	151	78.00.04	209	78.41.00	131
76.06.83	153	76.10.17	151	78.00.05	209	78.41.02	130, 131
76.06.84	153	76.10.18	151	78.00.06	209	78.41.05	130, 131
76.06.85	153	76.10.19	151	78.00.07	209	78.41.06	130, 131
76.06.86	153	76.10.20	151	78.03.01	174	78.41.08	130, 131
76.06.87	153	76.10.22	151	78.03.02	174	78.41.10	130, 131
76.06.88	153	76.10.25	151	78.03.05	167	78.41.11	130, 131
76.06.89	153	76.10.58	152	78.03.07	167	88.00.02	202
76.06.90	153	76.10.59	152	78.03.08	162	88.00.10	203
76.06.92	153	76.10.60	152	78.03.10	167	88.00.11	203
76.06.95	153	76.10.61	152	78.03.30	164	88.00.20	203
76.07.08	151	76.10.62	152	78.03.31	164	88.00.21	203
76.07.09	151	76.10.63	152	78.03.35	164	88.12.05	204
76.07.10	151	76.10.64	152	78.03.36	164	88.12.06	204
76.07.11	151	76.10.65	152	78.05.00	8	88.12.07	204
76.07.12	151	76.10.66	152	78.10.11	192	88.12.08	204
76.07.13	151	76.10.67	152	78.10.15	193	88.17.05	204



88.17.06	204
88.17.07	204
88.17.08	204
202.06.10	10
202.06.13	11
202.07.10	10
202.07.13	11
202.20.61	13
202.21.61	13
202.40.12	14
202.40.62	14
202.50.12	15
202.50.13	15
203.02.14	17
203.03.14	17
203.06.14	18
203.07.14	18
204.13.62	19
204.25.64	20
204.32.11	21
204.32.14	22
204.32.61	21
204.32.64	22
204.33.11	21
204.33.14	22
204.33.15	24
204.33.61	21
204.33.64	22
204.34.14	23
204.35.14	23
204.35.64	23
204.50.15	16
204.51.15	16
204.56.16	24
204.57.16	24
204.63.15	24
204.65.15	25
204.67.12	27
204.67.13	25
204.67.15	25
204.67.16	27
204.68.16	27
204.68.20	27
204.69.16	27
204.69.20	27
240.25.14	222
240.25.18	222
240.25.20	222
904.30.06	185
904.30.09	185
904.30.10	185
904.30.12	185



Medicon Instrumente

205	80,17,00
206	70,17,00
207	80,17,00
208	87,00,00
209	87,00,00
210	87,00,00
211	87,00,00
212	87,00,00
213	87,00,00
214	87,00,00
215	87,00,00
216	87,00,00
217	87,00,00
218	87,00,00
219	87,00,00
220	87,00,00
221	87,00,00
222	87,00,00
223	87,00,00
224	87,00,00
225	87,00,00
226	87,00,00
227	87,00,00
228	87,00,00
229	87,00,00
230	87,00,00
231	87,00,00
232	87,00,00
233	87,00,00
234	87,00,00
235	87,00,00
236	87,00,00
237	87,00,00
238	87,00,00
239	87,00,00
240	87,00,00
241	87,00,00
242	87,00,00
243	87,00,00
244	87,00,00
245	87,00,00
246	87,00,00
247	87,00,00
248	87,00,00
249	87,00,00
250	87,00,00

A					
ACLAND Approximator	80	BUCKLEY Flach- und Hohlmeißel	128	Extensionsbügel	163-164
ACLAND Clip Anlegepinzetten	81	Bulldog-Klemmen	73	Extraktions- und Faßzangen	161, 162
ACLAND Mikro-Gefäß-Clips	80	BUNNELL Handbohrapparat	168	Exzentrerscheibe für Gipssägeblätter	226
ADLERKREUTZ Gefäßpinzetten	39	BUNNELL Sehnensführer	194		
ADSON Nahtpinzetten	67	BUNNELL Sehnenschäler	195	F	
ADSON Pinzetten	34	BUNNELL Sonde	50	Fadenscheren	69
ADSON-BABY Präparierklemme	77	C		FANOUS Präparierscheren	27
ADSON-BROWN Pinzetten	35	CAROLL Sehnensfaßzangen	192	Faß- und Extraktionszangen	161, 162
ADSON-GRAEFE Pinzette	35	CASTROVIEJO Mikro-Nadelhalter	61	Feine Pinzetten	34-37
ADSON-JACOBSON Mikro-Pinzetten	45	CASTROVIEJO Mikroschere	32	Feine Scheren	9-16
ADSON-MICRO Pinzetten	35	CASTROVIEJO Nahtpinzetten	68	Finger-Extensionsbügel	163-164
AGRICOLA Wundspreizer	103	CASTROVIEJO Zirkel	220	Finger-Goniometer	219
ALLIS Gewebefaßzangen	200	CHAMPIONNIERE Handbohrer	171	Fingernagelbohrer	188
ALLIS-BABY Gewebefaßzangen	200	Chirurgische Pinzetten	34-39	Fingernagel-Instrumente	187-190
ALM Wundspreizer	103	Chirurgische Scheren	17-18	Fingernagelscheren	190
Anatomische Pinzetten	34-39	Clip Anlegepinzetten	81-83	Fingernagelzangen	189
ANDREWS PYNCHON Sauginstrument	52	Clip Anlegezangen	85	Fingerringhäkchen	100
Anlegepinzetten für Clips	81-83	COLLIN Dynamometer	218	Fingerringsägen	185
Anlegezangen für Clips	85	Container (Hinweis)	231	Fingerspreizer	104
Approximatoren	80, 82-83	CONVERSE Knochenfeile	106	FINSEN Wundspreizer	102
Approximatorschlüssel	82	CONVERSE Nadelhalter	55	FINSEN MODIF. Wundspreizer	102
ARRUGA Nadelhalter	60	COPE Wundhaken	90	FISCHER Sehnenschäler	195
Arterienklemmen	72-76	COTTLE Elevatorium	113	Fixierpinzetten	40
Atraumatische Gewebefaßzange	200	COTTLE Wundhaken	95, 100	Flachmeißel	124-129
Atraumatische Klemmen	73, 75	COTTLE "HM" Knochenraspel	107	Flachzangen	161
Atraumatische Pinzetten	38	COTTLE-MEDICON Flachmeißel	127	FOMON Schere	16
Atraumatische Sehnenshaltezege	192	CRILE WOOD Nadelhalter	58	FOMON Wundhaken	100
AUFRIEHT Schere	16	CRILE WOOD BABY Nadelhalter	58	FOMON "HM" Knochenraspel	109
Ausschlaginstrument für Marknägel	147	CUSHING anatomische Pinzetten	39	FOX Gewebe- und Knorpelfaßpinzetten	40
		CUSHING Wundhaken	92, 93	FRAMER Finger-Extensionsbügel	164
				FRAMER Sehnensführer	194
B		D		FRAZIER Sauginstrumente	52
BABY-ALLIS Gewebefaßzangen	200	DEBAKEY atraumatische Pinzetten	38	FRAZIER Wundhaken	94
BABY-CRILE-WOOD Nadelhalter	58	DEBAKEY "AT" Arterienklemmen	73	FREER Elevatoren	112
BABY-METZENBAUM Präparierscheren	21	DELIMA-HARDT Flachmeißel	125	FREER Flachmeißel	128
BABY MOSQUITO HARTMANN		Dermatome	5-8	FREER Wundhaken	96
Arterienklemmen	74	DERF-CONVERSE Nadelhalter	57	FRIEDMANN Hohlmeißelzange	138
BACKHAUS Tuchklemmen	77	DERF WRIGHT Nadelhalter	57	Führungshohlsonden	66
BALLENGER HAJEK Elevatorium	113	DESCHAMPS Führungshohlsonde	66	Fußschalter für Koagulations-Gerät	203
Bandmaße	218	DESCHAMPS-BABY Unterbindungsnadel	65		
BARON (SCHUKNECHT) Absaugröhrchen	52	DESMARRES Wundhaken	99	G	
BARRAQUER Mikro-Nadelhalter	61	DIEFFENBACH Arterienklemmen	73	Gabelschlüssel für Gipssäge	226
BARSKY Wundhaken	94	DIETHRICH Arterienklemmen	72	GALLAHER Knochenraspel	107
BEEBEE Draht- und Blechschere	157	DINGMAN Knochenhalte zangen	143	Gefäßclips	79-80, 82-84
Begrenzungsscheibe für Gipssägeblätter	226	Dissektoren	120	Gefäßhaken	93
BERGMANN Wundhaken	95	DOYEN Hammer	122	Gefäßpinzetten	39
BEYER Hohlmeißelzangen	138, 140	Drahtinstrumente	155-162	Gefäß-Spreizpinzette	85
BIEMER Anlegepinzetten	82-83	Drahtschneidezangen	158-160	GERALD anatomische Pinzetten	39
BIEMER Approximatoren	82-83	Drahtspannzangen	161	Gewebefaßpinzetten	40
BIEMER Mikro-Gefäßklemmen	82	Drahtspitzzangen	162	Gewebefaßzangen	199-200
Binokulare Stirnlupen	214-215	Draht- und Blechscheren	156-157	Gewebescheren	28
Bipolare Pinzetten	204	Dynamometer	218	GILLIES Pinzette	37
Bipolares Koagulationsgerät und Zubehör	202-203			GILLIES Wundhaken	94
BLACK Knochenfeile	106	E		GILLIES OBWEGESER Nadelhalter	54-55
Blech- und Drahtscheren	156-157	Einschlaginstrument für Marknägel	147	Gipsabreißzange	223
Bleihände	207-209	Elektrische Gipssäge und Zubehör	224-226	Gipssäge elektrisch	224-226
BLUMENTHAL Hohlmeißelzange	138	Elevatoren	111-113	Gipsschere	223
Blutstillungsmeißel	129	Ersatzklingen (Dermatome)	6-8	Gips- und Verbandinstrumente	221-226
BOEHLER-WOLFF Gipsabreißzange	223	Ersatzsägeblätter	179, 181, 183, 185, 226	GOLDSTEIN LOGAN Wundspreizer	103
Bohrapparate	165-171	Ersatzschlüssel für Approximator	82	Goniometer	219
Bohrdrähte	151-153	Ersatzschlüssel		GRAEFE Gewebefaßpinzetten	40
Bohrdrahtspender	154	für Bohrapparate	167, 168, 169, 170	GRAEFE Wundhaken	99
Bohrer	171	Ersatzschlüssel für Mikrosägen	178, 180, 182	GRAEFE ADSON Pinzette	35
BOWMAN Sonden	49	Ersatz-Sprührohraufsatz		GRAMCKO-BUCK Knochenheber	176
BOYNTON Nadelhalter	60	für Mikro-Stichsäge	183	GREEN Gewebefaßpinzetten	40
BRAND Sehnensführungszangen	193	Etuis	228-229	GREEN-LANGENBECK Wundhaken	91
BRAND Sehnenschäler	195, 196	Etui für Lupenbrillen	213	GREEN-SENN Wundhaken	91
BROWN Nadelhalter	57	EXCENTRIC-LISTER Verbandschere	222	GREENBERG PAR (SHEA) Präparierscheren	19
BROWN-ADSON Pinzetten	35			GROSS Kornzangen	88
BRÜSER-KELLY Präparierscheren	24			Grundsieb Handchirurgie	234-235
BUCK-GRAMCKO Knochenheber	176				

Gummiringe für Bleihände 209
GUTHRIE Wundhaken 96

H

HACKSTOCK
Knochendraht-Extensionszange 162
Hämmer 121-122
HAJEK Hammer 122
HAJEK-BALLENGER Elevatorium 113
Hakenmarknägel 146
HALSEY Nadelhalter 56
HALSTED-MEDICON Nadelhalter 54
HALSTED-MICRO Arterienklemmen 74
HALSTED-MOSQUITO
Arterienklemmen 75
Handbohrapparate 168-170
Handbohrer 171
Handbohrgriffe 167
Handschnittmesser 8
HARDT-DELIMA Flachmeißel 125
HARTMANN (BABY MOSQUITO)
Arterienklemmen 74
Hauthaken 94-95
Haut-Spannplatte (zu Dermatom) 7
HEGAR MAYO Nadelhalter 57
HEGAR OLSEN Nadelhalter 59
HENTON Unterbindungsnadeln 65
HINDERER Knorpelfaßpinzette 40
"HM" Drahtschneidezangen 158
"HM" Drahtspannzangen 161
"HM" Draht- und Blechscheren 156-157
"HM" Knochenraspel 107, 109
"HM" Nadelhalter 54-61
"HM" Pinzetten 34, 38-39
"HM" Scheren 13, 17-18, 20-23
Hochfrequenz-Chirurgie 201-204
Hohlmeißel 126-129
Hohlmeißelzangen 138-140
Hohlsonden 48
HUMBY Dermatom 6
HUMBY Wundhaken 94
HYLIN Raspatorium 117

I

IRIS Pinzetten 36
IRIS Scheren 12-13

J

JABELEY Scheren 11
JACKSON Wundhaken 90
JACKSON OMBREDANNE
Sehnenfaßzange 192
JACOBSON Mikro-Nadelhalter 61
JACOBSON Mikro-Pinzetten 45
JACOBSON-ADSON
Mikro-Pinzetten 45
JACOBSON-MICRO
Arterienklemmen 74
JAMESON Schieblehre 219
JAMESON REYNOLDS
Präparierscheren 26-27
JANSEN-ZAUFAL Hohlmeißelzangen 140
JOHNS-HOPKINS Arterienklemme 73
JOSEPH Knochenfeile 106
JOSEPH Meßstab 220
JOSEPH Raspatorium 116
JOSEPH Säge 184
JOSEPH Scheren 16
JOSEPH Wundhaken 95

K

KAHRE-WILLIGER Raspatorien 115
KELLY Arterienklemmen 75
KELLY-BRÜSER Präparierscheren 24
KERN Knochenhaltezzangen 143
Kennzeichnungsschild "SHEPARD
OSTEOTOM" für MEDICONTAINER 132
KILNER RAGNELL Präparierscheren 19
KIRSCHNER Bohrdrähte 151-153
KISTNER Sonden 50
KLEINERT-KUTZ Hohlmeißelzangen 139, 140
KLEINERT-KUTZ Knochensplitterzange 141
KLEINERT-KUTZ Sehnenführungszangen 193
KLEINERT-KUTZ Wundhaken 95
Klemmen 72-77, 79-80, 82-84
KNAPP Scheren 13
KNAPP Wundhaken 96
Knochendrähte 149-150
Knochendraht-Extraktionszange 162
Knochenfeilen 105-106
Knochenhaltezzangen 142-144
Knochenhebel 175-176
Knochenkürette 120
Knochenpfieme 173-174
Knochenraspeln 107-109
Knochenschere 144
Knochensplitterzangen 141
Knochenzangen 137-144
Knorpelfaßpinzetten 40
Knorpelscheren 28
Koagulator bipolar 202
KOCHER Arterienklemmen 76
KOCHER MATHIEU Nadelhalter 60
KOENIG Führungshohlsonden 66
KOENIG Wundhaken 92
Komprimeter 205-206
Kornzangen 87-88
Kreissägeblätter für Gipssäge 226
KUTZ KLEINERT Hohlmeißelzangen 139, 140
KUTZ KLEINERT Knochensplitterzange 141
KUTZ KLEINERT Sehnenführungszangen 193
KUTZ KLEINERT Wundhaken 95

L

Lagergestelle für Mikroinstrumente 230
LAHEY CLINIC Wundhaken 94
LAMBOTTE MINI Flachmeißel 124
LANGENBECK Säge 184
LANGENBECK Wundhaken 99
LANGENBECK-GREEN Wundhaken 91
LANZ MOD. Dissektor 120
LANZ MOD. Knochenhaltezzange 142
LANZ MOD. Knochenpfiem 174
LANZ MOD. Raspatorium 117
LANZ MOD. Sehenschäler 196
LANZ MOD. Sonde 50
LANZ MOD. Wundhaken 91, 96
LARSEN Sehnenfaßpinzetten 192
Leinenbandmaß 218
LEMPERT Hohlmeißelzangen 139
LEMPERT Raspatorien 116
LEMPERT scharfe Löffel 135
LERICHE Arterienklemmen 5
LEWIS "HM" Knochenraspel 107
LEXER MINI Flach- und Hohlmeißel 129
Ligaturklemmen 77
LISTER "Supercut" Verbandscheren 222
LISTER Verbandscheren 222
LISTER-EXCENTRIC Verbandschere 222
LISTON LITTAUER Knochensplitterzange 141
LISTON-MINI Knochensplitterzangen 141
LISTON-RUSKIN Knochensplitterzange 141

LITTAUER Fadenschere 69
LITTAUER-LISTON Knochensplitterzange 141
LITTLE Wundhaken 92
LITTLER Schere 16
LOCKLIN Gewebeschere 28
LOGAN (GOLDSTEIN) Wundspreizer 103
LUCAE Wundhaken 93
LUER Hohlmeißelzange 138
LUER Wundhaken 90
LUKENS Wundhaken 90
Lupenbrillen, Stirnlupen 211-215

M

MACDONALD Dissektor 120
MACHATT Wundhaken 96
MAIER Kornzange 88
MALTZ Knochenraspel 107
Marknägel und Zubehör 145-147
MARKWALDER Knochensplitterzangen 141
MARTIN Knorpelscheren 28
MARTINI scharfe Löffel 136
MASING Knochenfeile 106
MASING Knochenraspel 107
MATHIEU Raspatorium 116
MATHIEU Wundhaken 90
MATHIEU-KOCHER Nadelhalter 60
MAYO-HEGAR Nadelhalter 57
MCINDOE Pinzette 37
MCINDOE-MEDICON
Knochensplitterzange 141
MCKENTY Raspatorium 115
MCPHERSON Nahtpinzetten 68
MCPHERSON VANNAS Mikro-Scheren 32
MEDICON Drahtspannzangen 161
MEDICON Hammer 122
MEDICON Wundspreizer 103
MEDICON-BIPOLAR Koagulator 202
MEDICON-HALSTED Nadelhalter 54
MEDICON MCINDOE
Knochensplitterzange 141
MEDICONTAINER (Hinweis) 231
Meißel 123-129
Meßinstrumente 217-220
Meßstäbe 218-220
Metalletuis 228-229
METZENBAUM Präparierscheren 21-24
METZENBAUM-BABY Präparierscheren 21
METZENBAUM-SLIM Präparierscheren 23
MEYERDING Wundhaken 91
MICRO 2000 Nadelhalter 62-63
MICRO 2000 Nahtpinzetten 67
MICRO 2000 Pinzetten 41-44
MICRO 2000 Scheren 29-30
MICRO-Coagulator, bipolar 202
MICRO Pinzetten 41-45
MICRO-ADSON Pinzetten 35
MICRO-HALSTED Arterienklemmen 74
MICRO-HARTMANN Arterienklemmen 74
MICRO JACOBSON Arterienklemmen 74
Mikro-Gefäß-Clips 79-80, 82-84
Mikro-Nadelhalter 61-64
Mikro-Raspatorium 118
Mikrosäge Osseoskalpell 180-181
Mikrosäge oszillierend 178-179
Mikro-Sägen 178-183
Mikro-Scheren 12, 29-32
Mikro-Stichsäge 182-183
MILLARD (COTTLE)
Fingerringhäkchen 100
MILLER Knochenfeilen 106
MILLER Knochenkürette 120
MINI-LAMBOTTE Flachmeißel 124
MINI-LEXER Flach- und Hohlmeißel 129

MINI-LISTON Knochensplitterzange	141	Raspelaufsatz für Mikro-Stichsäge	183	Sterilgut-Container	
MINI-RUSKIN Hohlmeißel	140	Reibahlen	173-174	für Zylinder Osteotome	132
MINI-RYDER Nadelhalter	58	Repositonzangen	142	Sterilgut-Container (Hinweis)	231
Mittelvalven für Wundspreizer	103	REYNOLDS (JAMESON)		Sterilisieretuis	229
MIXTER-BABY Präparierklemme	77	Präparierscheren	26-27	Sterilisiergestelle für Mikroinstrumente	230
MOBERG Flachmeißel	127	ROCHESTER-OCHSNER		STEVENS Scheren	14-15, 25
MOLDESTAD Wundhaken	93	Arterienklemmen	76	STEVENSON Wundspreizer	103
MOLT Raspatorien	114	ROCHESTER-PEAN Arterienklemmen	76	Stichsäge	182-183
MOSQUITO "AT" Arterienklemmen	75	ROLLET Wundhaken	96	STILLE Flach- und Hohlmeißel	128
MOSQUITO HALSTED Arterienklemmen	75	ROSE Wundhaken	91	STILLE-MINI Gipsschere	223
MUCK Periostmesser	120	RUSKIN-LISTON Knochensplitterzange	141	STILLE-STRANDELL Wundhaken	92
Myrtenblattsonde	48	RUSKIN-MINI Hohlmeißelzangen	140	Stirnlupen binokular	214-215
		RYDER (FRENCH EYE) Nadelhalter	58	Stirnlupen, Lupenbrillen	211-215
		RYDER-MINI Nadelhalter	58	STRAIGHT Wundhaken	94
N				STRANDELL-STILLE Wundhaken	92
Nadelhalter	54-64	S		"Supercut" Scheren 10-11, 14-18, 21-25, 27	
Nadelhalter "HM"	54-61	SACHSE Osseoskalpell	180-181	"Supercut" Verbandscheren	222
Nagelausreißzange	189	SACHSE oszillierende Mikrosäge	178-179	"Supercut plus" Scheren	13-14, 19-23
Nagelspaltschere	190	Sägeblätter	179, 181, 183, 185, 226		
Nagelspaltzange	189	Sägeblätter für Gipssäge	226	T	
Nahtinstrumente	53-69	Sägen	177-186	TRAUTMANN Hohlmeißel	126
Nahtpinzetten	67-68	Sauginstrumente	51-52	Tuchklemmen	77
NEIVERT Nadelhalter	56	Scharfe Löffel	133-136	Tupferzangen	88
Nervhaken	93	Scheren	9-32	Tunnellierinstrument	194
NEWS Wundhaken	94	Schieblehren	219	TYRELL Wundhaken	99
NIRO Drahtspannzangen	161	SCHINK Dermatome	7		
NIRO Knochensplitterzange	141	Schlüssel für Bohrapparate	167, 168, 169, 170	U	
		Schlüssel für Gipssäge	226	ULRICH Knochenhalte-zangen	144
O		Schlüssel für Mikrosägen	178, 180, 182	ULRICH Tupferzangen	88
OBWEGESER Flachzange	161	SCHUCHARDT Knochenschere	144	UNIVERSAL Draht- und Blechscheren	156
OBWEGESER Drahtschneidezangen	160	SCHUKNECHT Drahtschere	156	Unterbindungsnadeln	65
OBWEGESER Drahtspitzzangen	162	SCHUKNECHT BARON Absaugröhrchen	52	Unterminierschere	11, 12
OBWEGESER Knochenraspeln	108	SCHWARZ Finger-Extensionsbügel	164		
OBWEGESER Osteotom	129	SEBILEAU Elevatorium	112	V	
OBWEGESER Raspatorien	118	Sehneneinflechtklemmen	197	VANNAS Mikroscheren	31-32
OBWEGESER-GILLIES Nadelhalter	54-55	Sehnenfaßpinzetten	192	VANNAS MCPHERSON	
OCHSNER ROCHESTER Arterienklemmen	76	Sehnenfaßzangen	192	Mikro-Scheren	32
Öhrsonden	48	Sehnenführer	194	Venenhaken	92-93
OLSEN-HEGAR Nadelhalter	59	Sehnenführungszangen	193	Verbandscheren	222
OLSEN-HEGAR-MINI Nadelhalter	59	Sehnenhalte-zangen	192	Verband- und Gipsinstrumente	221-226
OMBREDANNE (JACKSON)		Sehnen-Instrumente	191-197	VERBRUGGE Knochenhalte-zange	144
Sehnenfaßzange	192	Sehnen-schäler	195-196	VOLKMANN scharfe Löffel	135
Osseoskalpell Mikrosäge	180-181	Sehnen-schälmeißel	196	Vorböhrer für Marknägel	147
Osteosynthese Systeme (Hinweis)	242	SELECT Pinzetten	37	Vorsatzobjektive für Lupenbrillen	212
Osteotome	129, 130	SEMKEN Pinzetten	36		
Oszillierende Mikrosäge	178-179	SENN-GREEN Wundhaken	91	W	
		SENN-MILLER Wundhaken	90	WAGNER Scheren	10, 11
P		SENNING Nadelhalter	59	WALTER Sauginstrumente	52
PEAN Arterienklemmen	76	S.G.H. Hohlmeißelzange	138	WALTER scharfer Löffel	136
Periostmesser	120	SHEA GREENBERG PAR		WALTER WILLIGER scharfer Löffel	136
PERTHES Reibahlen	174	Präparierscheren	19	WARD Raspatorium	116
Phalangenhalte-zange	142	SHEEHAN Flachmeißel	126	WEBSTER Nadelhalter	56
Pinzetten	33-45	SHEEHAN Hohlmeißel	127	WECKER Mikroschere	32
Pinzetten, bipolar	204	SHEPARD Osteotome und Zubehör	130-132	WEITLANER Wundspreizer	104
POTTS SMITH anatomische Pinzette	38	Siebvorschläge für die Handchirurgie	233-239	WEST Flach- und Hohlmeißel	128
Präparierklemmen	77	Silikon-Noppenmatte		WIBERG Raspatorien	116
Präparierscheren	19-27	für Shepard Osteotome	132	WILLIGER Elevatorien	112
PROVIDENCE-HOSPITAL		Skalpelle	1-3	WILLIGER Raspatorien	115
Arterienklemmen	75	Skalpellgriffe	3	WILLIGER scharfe Löffel	136
PYNCHON ANDREWS Sauginstrument	52	Skalpellklingen	2	WILLIGER KAHRE Raspatorien	115
		SLIM Präparierscheren	20, 23	WILLIGER-WALTER scharfe Löffel	136
R		SMEDBERG Handbohrapparat	170	Winkelhandstück für Bohrdrähte	166
Racks	230	Sonden	47-50	WOLFF-BOEHLER	
RADOLF Nagelausreißzange	189	SPENCER Fadenschere	69	Gipsabreißzange	223
RAGNELL Wundhaken	90	Spiralbohrer für Handgriffe	171	WRIGHT (DERF) Nadelhalter	57
RAGNELL (KILNER) Präparierscheren	19	SPRATT scharfe Löffel	135	Wundhaken	89-100
RALK Handbohrapparat	169	Spreizpinzette für Gefäße	85	Wundspreizer	101-104
Raspatorien	114-118	Sprührohr-aufsatz für Mikro-Stichsäge	183		
		Stahl-Bandmaß	218		
		Stahl-Meßstäbe	218		
		STANDARD anatomische Pinzette	38		
		STEINMANN Sehnenhalte-zangen	192		
		STELLBRINK Hohlmeißelzangen	139		

A

ACLAND Approximator	80
ACLAND Clip applying forceps	81
ACLAND Micro vessel clips	80
ADLERKREUTZ Vessel forceps	39
ADSON Forceps	34
ADSON Suture forceps	67
ADSON-BABY Dissecting forceps	77
ADSON-BROWN Forceps	35
ADSON-GRAEFE Forceps	35
ADSON-JACOBSON Micro forceps	45
ADSON-MICRO Forceps	35
AGRICOLA Self-retaining retractor	103
ALLIS Tissue grasping forceps	200
ALLIS-BABY Tissue grasping forceps	200
ALM Self-retaining retractor	103
ANDREWS PYNCHON	
Aspirating instrument	52
Applying forceps for clips	81-83, 85
Approximator key	82
Approximators	80, 82-83
ARRUGA Needle holder	60
Artery forceps	72-76
Aspirating instruments	51-52
Atraumatic forceps	38, 73, 75
Atraumatic tendon holding forceps	192
Atraumatic tissue grasping forceps	200
AUFRIEHT Scissors	16

B

BABY-ALLIS Tissue grasping forceps	200
BABY-CRILE-WOOD Needle holder	58
BABY-METZENBAUM Dissecting forceps	21
BABY MOSQUITO HARTMANN	
Artery forceps	74
BACKHAUS Towel clamps	77
BALLENGER HAJEK Elevator	113
Bandage and plaster instruments	221-226
Bandage scissors	222
BARON (SCHUKNECHT)	
Aspirating tube	52
BARRAQUER Micro needle holder	61
BARSKY Retractor	94
Basic set hand surgery	234-235
BEEBEE Wire cutting scissors	157
BERGMANN Retractor	95
BEYER Rongeurs	138, 140
BIEMER Applying forceps	82-83
BIEMER Approximators	82-83
BIEMER Micro vessel clips	82
Binocular headband loupe	214-215
Bipolar coagulator and accessories	202-203
Bipolar forceps	204
BLACK Bone file	106
BLUMENTHAL Rongeur	138
BOEHLER-WOLFF Plaster cast breaker	223
Bone curettes	120
Bone cutting forceps	141
Bone files	105-106
Bone forceps	137-144
Bone holding forceps	142-144
Bone lever	175-176
Bone piercers	173-174
Bone rasps	107-109
Bone scissors	144
Bone suturing wires	149-150
Bone wire extraction plier	162
BOWMAN Probes	49
BOYNTON Needle holder	60
BRAND Tendon stripper	195-196
BRAND Tendon tunnelling forceps	193
BROWN Needle holder	57

BROWN-ADSON Forceps	35
BRÜSER-KELLY Dissecting scissors	24
BUCK-GRAMCKO Bone lever	176
BUCKLEY Chisels and gouges	128
Bulldog clamps	73
BUNNELL Hand drill	168
BUNNELL Probe	50
BUNNELL Tendon passer	194
BUNNELL Tendon stripper	195

C

Calipers	219-220
CAROLL Tendon grasping and holding forceps	192
Cartilage forceps	40
Cartilage scissors	28
Case for magnifying spectacles	213
Cases	228-229
CASTROVIEJO Caliper	220
CASTROVIEJO Micro needle holder	61
CASTROVIEJO Micro scissors	32
CASTROVIEJO Suture forceps	68
Center valves for self-retaining retractors	103
CHAMPIONNIERE Hand drill	171
Chisels	123-129
Circular saw blades for plaster saw	226
Clamps	72-77, 79-80, 82-84
Clip applying forceps	81-83, 85
Coagulator bipolar	202
COLLIN Dynamometer	218
Compass saw (micro)	182-183
Container (refer to prospectus)	231
CONVERSE Bone file	106
CONVERSE Needle holder	55
COPE Retractor	90
COTTLE Elevators	113
COTTLE Retractors	95, 100
COTTLE "HM" Bone rasp	107
COTTLE-MEDICON Chisel	127
Cotton swab forceps	88
CRILE WOOD Needle holders	58
CRILE WOOD BABY Needle holders	58
CUSHING Dressing forceps	39
CUSHING Retractors	92, 93
Cylinder osteotomes and accessories	130-132

D

DEBAKEY Atraumatic forceps	38
DEBAKEY "AT" Artery forceps	73
DELIMA-HARDT Chisels	125
DERF-CONVERSE Needle holder	57
DERF WRIGHT Needle holder	57
Dermatome	5-8
DESCHAMPS Ligature guides	66
DESCHAMPS-BABY Ligature needles	65
DESMARRES Retractors	99
DIEFFENBACH Artery forceps	73
DIETHRICH Artery forceps	72
DINGMAN Bone holding forceps	143
Disc for circular saw blades	226
Dissecting forceps	77
Dissecting scissors	19-27
Dissectors	120
DOYEN Mallet	122
Dressing / dissecting forceps	34-39
Dressing forceps	87-88
Dressing, tissue forceps	39
Drill handles	167
Drills	165-171
Dynamometer	218

E

Electric plaster saw and accessories	224-226
Electrosurgery	201-204
Elevators	111-113
Excentric disc for plaster saw blade	226
EXCENTRIC-LISTER Bandage scissors	222
Extension bow	163-164
Extraction / grasping forceps	161, 162
Extractor for hook-end intramedullary nails	147

F

FANOUS Dissecting scissors	27
Fine forceps	34-37
Fine scissors	9-16
Finger extension bow	163-164
Finger goniometer	219
Finger nail drill	188
Finger nail forceps	189
Finger nail instruments	187-190
Finger nail scissors	190
Finger ring cutter	185
Finger ring retractor	100
Finger spreader	104
FINSEN Self-retaining retractor	102
FINSEN MODIF. Self-retaining retractor	102
FISCHER Tendon stripper	195
Fixation forceps	40
Flat nose pliers	161
FOMON Retractor	100
FOMON Scissors	16
FOMON "HM" Bone rasp	109
Foot switch for coagulator Forceps	33-45
Forceps, bipolar	204
FOX Tissue and cartilage forceps	40
FRAMER Finger extension bow	164
FRAMER Tendon passers	194
FRAZIER Aspirating instruments	52
FRAZIER Retractors	94
FREER Chisels	128
FREER Elevators	112
FREER Retractors	96
FRIEDMANN Rongeurs	138

G

GALLAHER Bone rasps	107
GERALD Forceps dressing, dissecting	39
GILLIES Forceps	37
GILLIES OBWEGESER	
Needle holders	54-55
GILLIES Retractors	94
GOLDSTEIN LOGAN	
Self-retaining retractor	103
Goniometer	219
Gouges	126-129
GRAEFE Retractors	99
GRAEFE Tissue grasping forceps	40
GRAEFE ADSON Forceps	35
GRAMCKO-BUCK Bone lever	176
Grasping and extracting forceps	161, 162
GREEN Tissue and cartilage forceps	40
GREEN-LANGENBECK Retractors	91
GREEN-SENN Retractors	91
GREENBERG PAR (SHEA)	
Operating and dissecting scissors	19
GROSS Dressing forceps	88
GUTHRIE Retractors	96

H

HACKSTOCK	
Bone wire extraction plier	162
HAJEK Mallet	122
HAJEK-BALLENGER Elevator	113
HALSEY Needle holders	56
HALSTED-MEDICON Needle holders	54
HALSTED-MICRO Artery forceps	74
HALSTED-MOSQUITO Artery forceps	75
Hand drills	168-170
Hand knife	8
Hand piece angled for wires	166
HARDT-DELIMA Chisels	125
HARTMANN (BABY MOSQUITO) Artery forceps	74
Headband loupes, binocular	214-215
Headband loupes, Magnifying spectacles	211-215
HEGAR MAYO Needle holder	57
HEGAR OLSEN Needle holder	59
Hemostatic chisel	129
HENTON Ligature needles	65
HINDERER Cartilage grasping forceps	40
"HM" Bone rasp	107, 109
"HM" Forceps	34, 38-39
"HM" Needle holder	54-61
"HM" Scissors	13, 17-18, 20-23
"HM" Wire cutting pliers	158
"HM" Wire cutting scissors	156-157
"HM" Wire twisting forceps	161
Hook-end intramedullary nails and accessories	145-147
HUMBY Dermatome	6
HUMBY Retractors	94
HYLIN Raspatories	117

I

Identification label for MEDICONTAINER engraved "SHEPARD QSTEOTOME"	132
Impactor for hook-end intramedullary nails	147
IRIS Forceps	36
IRIS Scissors	12-13

J

JABELEY Scissors	11
JACKSON Retractors	90
JACKSON OMBREDANNE Tendon grasping forceps	192
JACOBSON Micro forceps	45
JACOBSON Micro needle holder	61
JACOBSON-ADSON Micro forceps	45
JACOBSON-MICRO Artery forceps	74
JAMESON Caliper	219
JAMESON REYNOLDS Operating, dissecting scissors	26-27
JANSEN-ZAUFAL Rongeurs	140
JOHNS-HOPKINS Artery forceps	73
JOSEPH Bone files	106
JOSEPH Measuring instrument	220
JOSEPH Raspatory	116
JOSEPH Retractors	95
JOSEPH Saw	184
JOSEPH Scissors	16

K

KAHRE-WILLIGER Raspatories	115
KELLY Artery forceps	75

KELLY-BRÜSER

Operating, dissecting scissors	24
KERN Bone holding forceps	143
KILNER RAGNELL Operating, dissecting scissors	19
KIRSCHNER Wire drills	151-153
KISTNER Probes	50
KLEINERT-KUTZ Bone cutting forceps	141
KLEINERT-KUTZ Retractors	95
KLEINERT-KUTZ Rongeurs	139, 140
KLEINERT-KUTZ Tendon tunnelling forceps	193
KNAPP Retractors	96
KNAPP Scissors	13
KOCHER Artery forceps	76
KOCHER MATHIEU Needle holders	60
KOENIG Ligature guides	66
KOENIG Retractors	92
KUTZ KLEINERT Bone cutting forceps	141
KUTZ KLEINERT Retractors	95
KUTZ KLEINERT Rongeurs	139, 140
KUTZ KLEINERT Tendon tunnelling forceps	193

L

LAHEY CLINIC Retractors	94
LAMBOTTE MINI Chisels	124
LANGENBECK Retractors	99
LANGENBECK Saw	184
LANGENBECK-GREEN Retractors	91
LANZ MOD. Bone holding forceps	142
LANZ MOD. Bone piercers	174
LANZ MOD. Dissector	120
LANZ MOD. Probe	50
LANZ MOD. Raspatory	117
LANZ MOD. Retractors	91, 96
LANZ MOD. Tendon stripper	196
LARSEN Tendon grasping forceps	192
Lead hands	207-209
LEMPERT Gouges	139
LEMPERT Raspatories	116
LEMPERT Sharp curettes	135
LERICHE Artery forceps	75
LEWIS "HM" Bone rasps	107
LEXER MINI Chisel and gouges	129
Ligature forceps	77
Ligature guides	66
Ligature needles	65
LISTER "Supercut" Bandage scissors	222
LISTER Bandage scissors	222
LISTER-EXCENTRIC Bandage scissors	222
LISTON LITTAUER Bone cutting forceps	141
LISTON-MINI Bone cutting forceps	141
LISTON-RUSKIN Bone cutting forceps	141
LITTAUER Stitch scissors	69
LITTAUER-LISTON Bone cutting forceps	141
LITTLE Retractors	92
LITTLER Scissors	16
LOCKLIN Tissue scissors	28
LOGAN (GOLDSTEIN) Self-retaining retractors	103
LUCAE Retractors	93
LUER Retractors	90
LUER Rongeurs	138
LUKENS Retractors	90

M

MACDONALD Dissector	120
MACHATT Retractor	96
Magnifying spectacles, binocular headband loupes	211-215

MAIER Dressing forceps	88
Mallets	121-122
MALTZ Bone rasps	107
MARKWALDER Bone cutting forceps	141
MARTIN Cartilage scissors	28
MARTINI Sharp curettes	136
MASING Bone file	106
MASING Bone rasp	107
MATHIEU Raspatory	116
MATHIEU Retractors	90
MATHIEU-KOCHER Needle holders	60
MAYO-HEGAR Needle holders	57
MCINDOE Forceps	37
MCINDOE-MEDICON Bone cutting forceps	141
MCKENTY Raspatory	115
MCPHERSON Suture forceps	68
MCPHERSON VANNAS Micro scissors	32
Measuring instruments	217-220
MEDICON Mallet	122
MEDICON Self-retaining retractor	103
MEDICON Wire twisting forceps	161
MEDICON-BIPOLAR Coagulator	202
MEDICON-HALSTED Needle holders	54
MEDICON MCINDOE Bone cutting forceps	141
MEDICONTAINER (refer to prospectus)	231
Metal cases	228-229
METZENBAUM Operating, dissecting scissors	21-24
METZENBAUM-BABY Operating, dissecting scissors	21
METZENBAUM-SLIM Operating, dissecting scissors	23
MEYERDING Retractors	91
MICRO 2000 Forceps	41-44
MICRO 2000 Needle holders	62-63
MICRO 2000 Scissors	29-30
MICRO 2000 Suture forceps	67
Micro coagulator, bipolar	202
Micro compass saw	182-183
Micro forceps	41-45
Micro needle holders	61-64
Micro oscillating saw	178-179
Micro osseoscalpel saw	180-181
Micro raspatory	118
Micro saw	178-183
Micro scissors	12, 29-32
Micro vessel clips	79-80, 82-84
MICRO-ADSON Forceps	35
MICRO-HALSTED Artery forceps	74
MICRO-HARTMANN Artery forceps	74
MICRO JACOBSON Artery forceps	74
MILLARD (COTTLE) Finger-ring retractor	100
MILLER Bone curette	120
MILLER Bone files	106
MINI-LAMBOTTE Chisel	124
MINI-LEXER Chisel and gouges	129
MINI-LISTON Bone cutting forceps	141
MINI-RUSKIN Rongeurs	140
MINI-RYDER Needle holders	58
MIXTER-BABY Dissecting forceps	77
MOBERG Chisel	127
MOLDESTAD Retractor	93
MOLT Raspatory	114
MOSQUITO "AT" Artery forceps	75
MOSQUITO HALSTED Artery forceps	75
MUCK Periosteal knife	120
Myrtle leaf probe	48

N

Nail pulling forceps	189
Nail splitter	189

Nail splitting scissors 190
 Needle holder "HM" 54-61
 Needle holder 54-64
 NEIVERT Needle holder 56
 Nerve hook 93
 NEWS Retractor 94
 NIRO Wire cutting forceps 141
 NIRO Wire twisting forceps 161
 Nose pliers 162

O

OBWEGESER Bone rasps 108
 OBWEGESER Flat nose plier 161
 OBWEGESER Nose pliers 162
 OBWEGESER Osteotomes 129
 OBWEGESER Raspatories 118
 OBWEGESER Wire cutting plier 160
 OBWEGESER-GILLIES
 Needle holder 54-55
 OCHSNER ROCHESTER
 Artery forceps 76
 OLSEN-HEGAR Needle holders 59
 OLSEN-HEGAR-MINI Needle holders 59
 OMBREDANNE (JACKSON)
 Tendon grasping forceps 192
 Operating scissors 17-18
 Oscillating micro saw 178-179
 Osseoscalpel micro saw 180-181
 Osteosynthesis systems
 (refer to prospectus) 242
 Osteotomes 129, 130

P

PEAN Artery forceps 76
 Periosteal knife 120
 PERTHES Reamers 174
 Phalanx holding forceps 142
 Plaster and bandage instruments 221-226
 Plaster cast breaker 223
 Plaster saw, electric 224-226
 Plaster shears 223
 Pneumatic tourniquet 205-206
 POTTS SMITH Dressing forceps 38
 Probes 47-50
 Proposals for hand surgery sets 233-239
 PROVIDENCE-HOSPITAL
 Artery forceps 75
 PYNCHON ANDREWS
 Aspirating instrument 52

R

Racks 230
 RADOLF Nail pulling forceps 189
 RAGNELL Retractors 90
 RAGNELL (KILNER) Dissecting scissors 19
 RALK Hand drill 169
 Rasp for micro compass saw 183
 Raspatories 114-118
 Reamers 173-174
 Replacement key for approximator 82
 Replacement key for hand drills 167, 168, 169, 170
 Replacement key for micro saw 178, 180, 182
 Reposition forceps 142
 Retractors 89-100
 REYNOLDS (JAMESON)
 Dissecting scissors 26-27
 ROCHESTER-OCHSNER Artery forceps 76

ROCHESTER-PEAN Artery forceps 76
 ROLLET Retractors 96
 Rongeurs 138-140
 ROSE Retractors 91
 Rubber bands for lead hands 209
 Rules 218-220
 RUSKIN-LISTON Bone cutting forceps 141
 RUSKIN-MINI Rongeurs 140
 RYDER (FRENCH EYE) Needle holders 58
 RYDER-MINI Needle holders 58

S

SACHSE Oscillating micro saw 178-179
 SACHSE Osseoscalpel saw 180-181
 Saw blades for plaster saw 226
 Saw blades 179, 181, 183, 185, 226
 Saws 177-186
 Scalpel blades 2
 Scalpel handles 3
 Scalpels 1-3
 SCHINK Dermatomes 7
 SCHUCHARDT Bone scissors 144
 SCHUKNECHT Wire cutting scissors 156
 SCHUKNECHT BARON Aspiration tube 52
 SCHWARZ Finger extension bow 164
 Scissors 9-32
 SEBILEAU Elevators 112
 SELECT Forceps 37
 Self-retaining retractors 101-104
 SEMKEN Forceps 36
 SENN-GREEN Retractors 91
 SENN-MILLER Retractors 90
 SENNING Needle holder 59
 S.G.H. Rongeur 138
 Sharp curettes 133-136
 SHEA GREENBERG PAR
 Dissecting scissors 19
 SHEEHAN Chisels 126
 SHEEHAN Gouges 127
 SHEPARD
 Osteotomes and accessories 130-132
 Silicon mat for Shepard osteotomes 132
 Skin holding plate (for dermatome) 7
 Skin hooks 94-95
 SLIM Dissecting scissors 20, 23
 Slip-on objectives for spectacles 212
 SMEDBERG Hand drills 170
 Spare blades (dermatomes) 6-8
 Spare irrigation tube for micro compass saw 183
 Spare saw blades 179, 181, 183, 185, 226
 SPENCER Stitch scissors 69
 SPRATT Sharp curettes 135
 Spreader for vessels 85
 Stainless steel rod 218
 Stainless steel rule 218
 STANDARD Dressing forceps 38
 STEINMANN Tendon holding forceps 192
 STELLBRINK Rongeur 139
 Sterilization container
 (refer to prospectus) 231
 Sterilization container for SHEPARD Osteotomes 132
 Sterilizing boxes 229
 Sterilizing racks for micro instruments 230
 STEVENS Scissors 14-15, 25
 STEVENSON Self-retaining retractors 103
 STILLE Chisels and gouges 128
 STILLE-MINI Plaster shears 223
 STILLE-STRANDELL Retractors 92
 Stitch scissors 69
 STRAIGHT Retractors 94
 STRANDELL-STILLE Retractors 92

"Supercut" Bandage scissors 222
 "Supercut" Scissors 10-11, 14-18, 21-25, 27
 "Supercut plus" Scissors 13-14, 19-23
 Supplementary set bone 238-239
 Supplementary set micro 237
 Supplementary tendon set 236
 Suture forceps 67-68
 Suture instruments 53-69

T

Tap for hook-end intramedullary nails 147
 Tape measures 218
 Tendon gouges 196
 Tendon grasping forceps 192
 Tendon holding forceps 192
 Tendon instruments 191-197
 Tendon interlacing forceps 197
 Tendon passers 194
 Tendon stripper 195-196
 Tendon tunnelling forceps 193
 Tissue and cartilage forceps 40
 Tissue grasping forceps 199-200
 Tissue scissors 28
 Towel clamps 77
 TRAUTMANN Gouges 126
 Tunnelling instrument 194
 Twist drill for drill handles 171
 TYRELL Retractors 99

U

ULRICH Bone holding forceps 144
 ULRICH Cotton swab forceps 88
 Undermining scissors 11, 12
 UNIVERSAL Wire cutting scissors 156

V

VANNAS Micro scissors 31-32
 VANNAS MCPHERSON Micro scissors 32
 Vein hook 92-93
 VERBRUGGE Bone holding forceps 144
 Vessel clips 79-80, 82-84
 Vessel hook 93
 Vessel spreader 85
 VOLKMANN Sharp curettes 135

W

WAGNER Scissors 10, 11
 WALTER Aspirating instruments 52
 WALTER Sharp curettes 136
 WALTER WILLIGER Sharp curettes 136
 WARD Raspatories 116
 WEBSTER Needle holders 56
 WECKER Micro scissors 32
 WEITLANER Self-retaining retractors 104
 WEST Chisels and gouges 128
 WIBERG Raspatories 116
 WILLIGER Elevators 112
 WILLIGER Raspatories 115
 WILLIGER Sharp curettes 136
 WILLIGER KAHRE Raspatories 115
 WILLIGER-WALTER Sharp curettes 136
 Wire cutting pliers 158-160
 Wire cutting scissors 156-157
 Wire dispenser 154
 Wire drills 151-153
 Wire instruments 155-162
 Wire wisting forceps 161

WOLFF-BOEHLER Plaster cast breaker 223
 Wrench for hand drills 167, 168, 169, 170
 Wrench for micro saw 178, 180, 182
 Wrench for plaster saw 226
 WRIGHT (DERF) Needle holder 57

Y

YASARGIL Clip applying forceps 85
 YASARGIL Micro forceps 45
 YASARGIL Micro needle holder 62
 YASARGIL Micro vessel clips 84
 YASARGIL Raspatories 118
 YASARGIL Scissors 31

Z

ZAUFAL-JANSEN Rongeurs 140

100
101
102
103
104
105
106
107
108
109
110
111
112
113
114
115
116
117
118
119
120
121
122
123
124
125
126
127
128
129
130
131
132
133
134
135
136
137
138
139
140
141
142
143
144
145
146
147
148
149
150
151
152
153
154
155
156
157
158
159
160
161
162
163
164
165
166
167
168
169
170
171
172
173
174
175
176
177
178
179
180
181
182
183
184
185
186
187
188
189
190
191
192
193
194
195
196
197
198
199
200
201
202
203
204
205
206
207
208
209
210
211
212
213
214
215
216
217
218
219
220
221
222
223
224
225
226
227
228
229
230
231
232
233
234
235
236
237
238
239
240
241
242
243
244
245
246
247
248
249
250
251
252
253
254
255
256
257
258
259
260
261
262
263
264
265
266
267
268
269
270
271
272
273
274
275
276
277
278
279
280
281
282
283
284
285
286
287
288
289
290
291
292
293
294
295
296
297
298
299
300
301
302
303
304
305
306
307
308
309
310
311
312
313
314
315
316
317
318
319
320
321
322
323
324
325
326
327
328
329
330
331
332
333
334
335
336
337
338
339
340
341
342
343
344
345
346
347
348
349
350
351
352
353
354
355
356
357
358
359
360
361
362
363
364
365
366
367
368
369
370
371
372
373
374
375
376
377
378
379
380
381
382
383
384
385
386
387
388
389
390
391
392
393
394
395
396
397
398
399
400
401
402
403
404
405
406
407
408
409
410
411
412
413
414
415
416
417
418
419
420
421
422
423
424
425
426
427
428
429
430
431
432
433
434
435
436
437
438
439
440
441
442
443
444
445
446
447
448
449
450
451
452
453
454
455
456
457
458
459
460
461
462
463
464
465
466
467
468
469
470
471
472
473
474
475
476
477
478
479
480
481
482
483
484
485
486
487
488
489
490
491
492
493
494
495
496
497
498
499
500

501
502
503
504
505
506
507
508
509
510
511
512
513
514
515
516
517
518
519
520
521
522
523
524
525
526
527
528
529
530
531
532
533
534
535
536
537
538
539
540
541
542
543
544
545
546
547
548
549
550
551
552
553
554
555
556
557
558
559
560
561
562
563
564
565
566
567
568
569
570
571
572
573
574
575
576
577
578
579
580
581
582
583
584
585
586
587
588
589
590
591
592
593
594
595
596
597
598
599
600
601
602
603
604
605
606
607
608
609
610
611
612
613
614
615
616
617
618
619
620
621
622
623
624
625
626
627
628
629
630
631
632
633
634
635
636
637
638
639
640
641
642
643
644
645
646
647
648
649
650
651
652
653
654
655
656
657
658
659
660
661
662
663
664
665
666
667
668
669
670
671
672
673
674
675
676
677
678
679
680
681
682
683
684
685
686
687
688
689
690
691
692
693
694
695
696
697
698
699
700
701
702
703
704
705
706
707
708
709
710
711
712
713
714
715
716
717
718
719
720
721
722
723
724
725
726
727
728
729
730
731
732
733
734
735
736
737
738
739
740
741
742
743
744
745
746
747
748
749
750
751
752
753
754
755
756
757
758
759
760
761
762
763
764
765
766
767
768
769
770
771
772
773
774
775
776
777
778
779
780
781
782
783
784
785
786
787
788
789
790
791
792
793
794
795
796
797
798
799
800
801
802
803
804
805
806
807
808
809
810
811
812
813
814
815
816
817
818
819
820
821
822
823
824
825
826
827
828
829
830
831
832
833
834
835
836
837
838
839
840
841
842
843
844
845
846
847
848
849
850
851
852
853
854
855
856
857
858
859
860
861
862
863
864
865
866
867
868
869
870
871
872
873
874
875
876
877
878
879
880
881
882
883
884
885
886
887
888
889
890
891
892
893
894
895
896
897
898
899
900
901
902
903
904
905
906
907
908
909
910
911
912
913
914
915
916
917
918
919
920
921
922
923
924
925
926
927
928
929
930
931
932
933
934
935
936
937
938
939
940
941
942
943
944
945
946
947
948
949
950
951
952
953
954
955
956
957
958
959
960
961
962
963
964
965
966
967
968
969
970
971
972
973
974
975
976
977
978
979
980
981
982
983
984
985
986
987
988
989
990
991
992
993
994
995
996
997
998
999
1000

1001
1002
1003
1004
1005
1006
1007
1008
1009
1010
1011
1012
1013
1014
1015
1016
1017
1018
1019
1020
1021
1022
1023
1024
1025
1026
1027
1028
1029
1030
1031
1032
1033
1034
1035
1036
1037
1038
1039
1040
1041
1042
1043
1044
1045
1046
1047
1048
1049
1050
1051
1052
1053
1054
1055
1056
1057
1058
1059
1060
1061
1062
1063
1064
1065
1066
1067
1068
1069
1070
1071
1072
1073
1074
1075
1076
1077
1078
1079
1080
1081
1082
1083
1084
1085
1086
1087
1088
1089
1090
1091
1092
1093
1094
1095
1096
1097
1098
1099
1100
1101
1102
1103
1104
1105
1106
1107
1108
1109
1110
1111
1112
1113
1114
1115
1116
1117
1118
1119
1120
1121
1122
1123
1124
1125
1126
1127
1128
1129
1130
1131
1132
1133
1134
1135
1136
1137
1138
1139
1140
1141
1142
1143
1144
1145
1146
1147
1148
1149
1150
1151
1152
1153
1154
1155
1156
1157
1158
1159
1160
1161
1162
1163
1164
1165
1166
1167
1168
1169
1170
1171
1172
1173
1174
1175
1176
1177
1178
1179
1180
1181
1182
1183
1184
1185
1186
1187
1188
1189
1190
1191
1192
1193
1194
1195
1196
1197
1198
1199
1200
1201
1202
1203
1204
1205
1206
1207
1208
1209
1210
1211
1212
1213
1214
1215
1216
1217
1218
1219
1220
1221
1222
1223
1224
1225
1226
1227
1228
1229
1230
1231
1232
1233
1234
1235
1236
1237
1238
1239
1240
1241
1242
1243
1244
1245
1246
1247
1248
1249
1250
1251
1252
1253
1254
1255
1256
1257
1258
1259
1260
1261
1262
1263
1264
1265
1266
1267
1268
1269
1270
1271
1272
1273
1274
1275
1276
1277
1278
1279
1280
1281
1282
1283
1284
1285
1286
1287
1288
1289
1290
1291
1292
1293
1294
1295
1296
1297
1298
1299
1300
1301
1302
1303
1304
1305
1306
1307
1308
1309
1310
1311
1312
1313
1314
1315
1316
1317
1318
1319
1320
1321
1322
1323
1324
1325
1326
1327
1328
1329
1330
1331
1332
1333
1334
1335
1336
1337
1338
1339
1340
1341
1342
1343
1344
1345
1346
1347
1348
1349
1350
1351
1352
1353
1354
1355
1356
1357
1358
1359
1360
1361
1362
1363
1364
1365
1366
1367
1368
1369
1370
1371
1372
1373
1374
1375
1376
1377
1378
1379
1380
1381
1382
1383
1384
1385
1386
1387
1388
1389
1390
1391
1392
1393
1394
1395
1396
1397
1398
1399
1400
1401
1402
1403
1404
1405
1406
1407
1408
1409
1410
1411
1412
1413
1414
1415
1416
1417
1418
1419
1420
1421
1422
1423
1424
1425
1426
1427
1428
1429
1430
1431
1432
1433
1434
1435
1436
1437
1438
1439
1440
1441
1442
1443
1444
1445
1446
1447
1448
1449
1450
1451
1452
1453
1454
1455
1456
1457
1458
1459
1460
1461
1462
1463
1464
1465
1466
1467
1468
1469
1470
1471
1472
1473
1474
1475
1476
1477
1478
1479
1480
1481
1482
1483
1484
1485
1486
1487
1488
1489
1490
1491
1492
1493
1494
1495
1496
1497
1498
1499
1500

A					
ACLAND Aproximador	80	BUNNELL Pasadores de tendones	194	E	
ACLAND Clips microvasculares	80	BUNNELL Perforadores de mano	168	Electrocirugía	201-204
ACLAND Pinzas para aplicar clips	81			Elevadores óseos	175-176
ADLERKREUTZ Pinza vascular	39	C		Elevadores	111-113
ADSON Pinzas	34	Caballote para esterilizar micro		Enucleador de tendones	195-196
ADSON Pinzas para suturas	67	instrumentos	230	Equipo para coagulación bipolar	202-203
ADSON-BABY Pinza para preparaciones	77	Caballetes	230	Escariadores	173-174
ADSON-BROWN Pinzas	35	Calibradores	219	Escofina para micro sierra	183
ADSON-GRAEFE Pinza	35	CAROLL Pinzas para sujetar y		Escofinas para huesos	105-109
ADSON-JACOBSON Micro-pinzas	45	agarrar tendones	192	Escoplos enucleadores de tendones	196
ADSON-MICRO Pinzas	35	CASTROVIEJO Compás	220	Estera de silicona para	
AGRICOLA Separador autostático	103	CASTROVIEJO Micro porta-agujas	61	Shepard osteótomo	132
Agujas para ligaduras	65	CASTROVIEJO Micro tijeras	32	Estiletos	47-50
Alambres para huesos	149-150	CASTROVIEJO Pinza para suturas	68	Estribos de extensión para dedos	163-164
Alicates de picos planos	161	CHAMPIONNIERE		Estribos de extensión	163-164
ALLIS Pinza para coger tejidos	200	Perforador de mano	171	Estuches de esterilización	229
ALLIS-BABY Pinza para coger tejidos	200	Cinceles	123-129	Estuches de metal	228-229
ALM Separador	103	Cinta métrica de metal	218	Estuches para gafas de lupa	213
ANDREWS PYNCHON		Cinta métrica de tela	218	EXCENTRIC-LISTER Tijera de vendajes	222
Instrumento de aspiración	52	Cirugía de alta frecuencia	201-204		
Anillos de goma para manoplas		Clavos medulares y accesorios	145-147		
de plomo	209	Clips microvasculares	79-80, 82-84	F	
Aproximadores	80, 82-83	Coagulador bipolar	202	FANOUS Tijeras	27
ARRUGA Porta-agujas	60	COLLIN Dinamómetro	218	FINSEN Separador	102
AUFRIEHT Tijera	16	Compás	220	FINSEN MODIF. Separador	102
		Conductoras para tendones	194	FISCHER Enucleador de tendones	195
		Conmutador a pedal para equipo bipolar	203	FOMON Separadores	100
		Contenedor para esterilización para		FOMON Tijera	16
		osteótomo cilíndrico	132	FOMON "HM" Lima de huesos	109
		Contenedores para esterilización		FOX Pinzas para tejidos y cartilagos	40
		(información general)	231	FRAMER	
B		CONVERSE Lima para huesos	106	Estribo de extensión para dedos	164
BABY-ALLIS Pinza para coger tejidos	200	CONVERSE Porta-agujas	55	FRAMER Pasador de tendones	194
BABY-CRILE-WOOD Porta agujas	58	COPE Separador	90	FRAZIER Instrumentos de aspiración	52
BABY-METZENBAUM		COTTLE Elevador	113	FRAZIER Separadores	94
Tijeras para preparaciones	21	COTTLE Escofinas para huesos "HM"	107	FREER Cinceles	128
BABY MOSQUITO HARTMANN		COTTLE Separador	95, 100	FREER Elevadores	112
Pinzas hemostáticas	74	COTTLE-MEDICON Cinceles	127	FREER Separadores	96
BACKHAUS Pinzas de campo	77	CRILE WOOD Porta-agujas	58	FRIEDMANN Pinza gubia	138
BALLENGER HAJEK Elevador	113	CRILE WOOD BABY Porta-agujas	58		
BARON (SCHUKNECHT)		Cucharilla ósea	120		
Instrumento de aspiración	52	Cucharillas cortantes	133-136	G	
BARRAQUER Micro porta-agujas	61	Cuchillo para periostio	120	Gafas de lupa, lupas frontales	211-215
BARSKY Separadores	94	Cuchillos de mano	8	GALLAHER Lima de hueso	107
Bastidores para esterilizar micro		Cureta de hueso	120	Ganchito en forma de anillo	100
instrumentos	230	CUSHING Pinzas anatómicas	39	Ganchos para venas	92-93
Bastidores	230	CUSHING Separadores	92, 93	Ganchos para nervios	93
BEEBEE Tijera para cortar hilo de acero	157			GERALD Pinzas anatómicas	39
BERGMANN Separador	95	D		GILLIES Pinza	37
BEYER Pinzas gubias	138, 140	DEBAKEY Pinzas atraumáticas	38	GILLIES Separadores	94
BIEMER Aproximadores	82-83	DEBAKEY Pinzas hemostáticas	73	GILLIES OBWEGESER Porta-agujas	54-55
BIEMER Clips microvasculares	82	DELIMA-HARDT Cinceles	125	GOLDSTEIN LOGAN Separador	103
BIEMER Pinza aplicadora	82-83	DERF-CONVERSE		Goniómetro para dedos	219
Bisturles	1-3	Porta-agujas	57	Goniómetro	219
BLACK Lima para huesos	106	DERF WRIGHT Porta-agujas	57	GRAEFE Pinza para tejido	40
BLUMENTHAL Pinza gubia	138	Dermatomo	5-8	GRAEFE Separador	99
BOEHLER-WOLFF Pinza para arrancar		DESCHAMPS		GRAEFE ADSON Pinza	35
vendajes enyesados	223	Sondas conductoras acanaladas	66	GRAMCKO-BUCK Elevador óseo	176
BOWMAN Estiletos	49	DESCHAMPS-BABY		GREEN Pinza para tejido	40
BOYNTON Porta-agujas	60	Agujas para ligaduras	65	GREEN-LANGENBECK Separadores	91
BRAND Enucleador de tendones	195, 196	DESMARRES Separadores	99	GREEN-SENN Separadores	91
BRAND		DIEFFENBACH		GREENBERG PAR (SHEA)	
Pinza conductora para tendones	193	Pinzas hemostáticas	73	Tijeras de preparación	19
Brocas espirales para mangos de		DIETHRICH		GROSS Pinza para tapones	88
perforadores	171	Pinzas hemostáticas	72	Gubias	126-129
Brocas filiformes	149-153	Dinamómetro	218	GUTHRIE Separador	96
Brocas	171	DINGMAN Pinzas para huesos	143		
BROWN Porta-agujas	57	Disco excéntrico para sierras circulares	226	H	
BROWN-ADSON Pinzas	35	Disectores	120	HACKSTOCK	
BRÜSER-KELLY		Dispensador de alambres	154	Pinza para extracción de hilos	162
Tijeras para preparaciones	24	DOYEN Martillo	122		
BUCK-GRAMCKO Elevador oséo	176				
BUCKLEY Cinceles y gubias	128				
Bulldog pinzas hemostáticas	73				
BUNNELL Enucleador de tendones	195				
BUNNELL Estilete	50				

MOSQUITO "AT" Pinzas hemostáticas	75
MOSQUITO HALSTED	
Pinzas hemostáticas	75
MUCK Cuchillo para periostio	120

N

NEIVERT Porta-agujas	56
NEWS Separador	94
NIRO Pinzas cortantes para huesos	141
NIRO Pinzas tensoras para alambre	161

O

Objetivos adicionales para gafas de lupa	212
OBWEGESER Alicata	161
OBWEGESER Escofina	108
OBWEGESER Legras	118
OBWEGESER Osteótomo	129
OBWEGESER Pinzas corta-alambre	160
OBWEGESER Pinzas para alambre	162
OBWEGESER-GILLIES Porta-aguajs	54-55
OCHSNER ROCHESTER	
Pinzas hemostáticas	76
OLSEN-HEGAR Porta-agujas	59
OLSEN-MINI Porta-agujas	59
OMBREDANNE (JACKSON)	
Pinza para agarrar tendones	192
Osseoscalpel micro sierra	180-181
Osteosintesis (indicación a sistemas)	242
Osteótomo cilíndrico y accesorios	130-132
Osteótomos	129, 130

P

PEAN Pinzas hemostáticas	76
Pedal de pie para equipo bipolar	203
Perforador de uñas	188
Perforadores de mano	168-171
Perforadores	165-171
PERTHES Escariadores	174
Pieza de mano angulada para alambres de Kirschner	166
Pinza arranca-uñas	189
Pinza corta uñas	189
Pinza de agarrar falanges	142
Pinza dilatador vascular	85
Pinza para arrancar vendajes enyesados	223
Pinza para extracción de hilos de acero	162
Pinza para hender uñas	190
Pinzas anatómicas	34-39
Pinzas aplicadoras para clips	85
Pinzas atraumáticas	38
Pinzas bipolares	204
Pinzas conductoras para tendones	193
Pinzas corta-alambre	158-160
Pinzas cortantes para huesos	141
Pinzas de campo	77
Pinzas de extracción	161, 162
Pinzas de reposición	142
Pinzas finas	34-37
Pinzas gubias	138-140
Pinzas hemostáticas atraumáticos	73, 75
Pinzas hemostáticas	72-76
Pinzas para agarrar tendones	192
Pinzas para alambre	162
Pinzas para aplicar clips	81-83
Pinzas para aplicar clips	81-83,85

Pinzas para cartilagos	40
Pinzas para coger tejidos con estriado atraumático	200
Pinzas para coger tejidos	199-200
Pinzas para cordales impactados	142
Pinzas para entrelazar tendones	197
Pinzas para extracción	161, 162
Pinzas para fijación	40
Pinzas para huesos	137-144
Pinzas para ligaduras	77
Pinzas para preparaciones	77
Pinzas para reducción	142
Pinzas para sujetar y agarrar tendones	192
Pinzas para suturas	67-68
Pinzas para tapones	87-88
Pinzas para tejidos	40
Pinzas para uñas	189
Pinzas porta-tapones	88
Pinzas quirúrgicas	34-39
Pinzas tensoras de alambre	161
Pinzas vasculares	39, 79-80, 82-84
Pinzas	33-45, 72-77, 79-80, 82-84
Pinzas, bipolares	204
Placa de identificación "SHEPARD OSTEOTOM" para MEDICONTAINER	132
Placa tensora de membrana (para dermatomo)	7
Porta-agujas "HM"	54-61
Porta-agujas	54-64
POTTS SMITH Pinza anatómica	38
Preperforador para clavos medulares	147
Proposiciones para sets de Cirugía de Mano	233-239
PROVIDENCE-HOSPITAL	
Pinzas hemostáticas	75
Punzón para hemostasia	129
Punzones	173-174
PYNCHON ANDREWS	
Instrumento para aspiración	52

R

Racks para esterilizar y conservar micro instrumentos	230
RADOLF Pinza arranca-uñas	189
RAGNELL Separadores	90
RAGNELL (KILNER)	
Tijeras para preparaciones	19
RALK Perforador de mano	169
Reglas de acero	218, 220
Retractores de piel	94-95
REYNOLDS (JAMESON)	
Tijeras de preparación	26-27
ROCHESTER-OCHSNER	
Pinzas hemostáticas	76
ROCHESTER-PEAN	
Pinzas hemostáticas	76
ROLLET Separador	96
ROSE Separador	91
RUSKIN-LISTON	
Pinza para cortar huesos	141
RUSKIN-MINI Pinzas gubias	140
RYDER (FRENCH EYE) Porta-agujas	58
RYDER-MINI Porta-agujas	58

S

SACHSE Micro sierra oscilante	178-179
SACHSE Osseoscalpel	180-181
SCHINK Dermatomo	7
SCHUCHARDT Tijera para huesos	144
SCHUKNECHT Tijera para alambre	156

SCHUKNECHT BARON	
Tubitos de aspiración	52
SCHWARZ	
Estribo de extensión para dedos	164
SEBILEAU Elevador	112
SELECT Pinzas	37
SEMKEN Pinzas	36
SENN-GREEN Separadores	91
SENN-MILLER Separadores	90
SENNING Porta agujas	59
Separador para dedos	104
Separadores autostáticos	101-104
Separadores vasculares	93
Separadores	89-100
Set adicional huesos	238-239
Set adicional micro	237
Set adicional tendones	236
Set básico Cirugía de Mano	234-235
S.G.H. Pinza gubia	138
SHEA GREENBERG PAR	
Tijeras de preparación	19
SHEEHAN Cíncel	126
SHEEHAN Pinza gubia	127
SHEPARD	
Osteótomo cilíndrico y accesorios	130-132
Sierra eléctrica de yeso	224-226
Sierra eléctrica para vendajes y accesorios	224-226
Sierra micro oscilante	178-179
Sierras para abrir anillos	185
Sierras	177-186
SLIM Tijeras de preparación	20, 23
SMEDBERG Perforador de mano	170
Sondas acanaladas	48
Sondas conductoras acanaladas	66
Sondas	48
SPENCER	
Tijeras para quitar puntos de sutura	69
SPRATT Cucharillas cortantes	135
STANDARD Pinzas anatómicas	38
STEINMANN	
Pinza para sujetar tendones	192
STELLBRINK Pinza gubia	139
STEVENS Tijeras	14-15, 25
STEVENSON Separadores	103
STILLE Cinceles y gubias	128
STILLE-MINI Cizallas para yeso	223
STILLE-STRANDELL Separadores	92
STRAIGHT Separadores	94
STRANDELL-STILLE	
Separadores	92
"Supercut" Tijeras para vendajes	222
"Supercut" Tijeras	10-11, 14-18, 21-25, 27
"Supercut plus" Tijeras	13-14, 19-23

T

Tijeras	9-32
Tijeras finas	9-16
Tijeras para cartilagos	28
Tijeras para cortar hilo de acero	156-157
Tijeras para huesos	144
Tijeras para preparaciones	19-27
Tijeras para quitar puntos de sutura	69
Tijeras para tejidos	28
Tijera para tunelización	11, 12
Tijeras para uñas	190
Tijeras para vendajes	222
Tijera para yeso	223
Tijeras quirúrgicas	17-18
Torniquete neumático	205-206
TRAUTMANN Gubia	126
Tubo de irrigación para micro sierra	183
TYRELL Separador	99

A

ACLAND Approximateur	80
ACLAND Micro clamps vasculaires	80
ACLAND Pincés pour poser les clips	81
ADLERKREUTZ Pincés vasculaires	39
ADSON Pincés	34
ADSON Pincés à sutures	67
ADSON-BABY Pince à préparations	77
ADSON-BROWN Pincés	35
ADSON-GRAEFE Pince	35
ADSON-JACOBSON Micro Pincés	45
ADSON-MICRO Pincés	35
AGRICOLA Ecarteur autostatique	103
Aiguilles à ligatures	65
Alènes à os	173-174
Alésoirs	173-174
ALLIS Pincés pour saisir les tissus	200
ALLIS-BABY Pincés pour saisir les tissus	200
ALM Ecarteurs autostatiques	103
Amorçoir pour clous médullaires	147
ANDREWS PYNCHON	
Instrument à aspiration	52
Anneaux en caoutchouc pour attelles de de plomb	209
Appareil HF bipolaire	202
Appareil HF pour coagulation bipolaire et accessoires	202-203
Approximateurs	80, 82-83
ARRUGA Porte-aiguilles	60
Attelles de plomb	207-209
AUFRIEHT Ciseaux	16

B

BABY-ALLIS	
Pincés pour saisir les tissus	200
BABY-CRILE-WOOD Porte-aiguille	58
BABY-METZENBAUM	
Ciseaux à préparations	21
BABY MOSQUITO HARTMANN	
Pincés hémostatiques	74
BACKHAUS Pincés à champs	77
BALLENGER HAJEK Elévateur	113
BARON (SCHUKNECHT)	
Canules d'aspiration	52
BARRAQUER Porte-aiguilles micro	61
BARSKY Crochets	94
BEEBEE Ciseaux coupe-fil	157
BERGMANN Ecarteurs	95
BEYER Pincés-gouges	138, 140
BIEMER Approximateurs	82-83
BIEMER Clips microvasculaires	82
BIEMER Pincés pour poser les clips	82-83
Bistouris	1-3
BLACK Limes à os	106
BLUMENTHAL Pince-gouge	138
BOEHLER-WOLFF	
Pince pour arracher les plâtres	223
Boîte générale pour la chirurgie de la main	234-235
Boîte supplémenaire os	238-239
Boîte supplémentaire micro	237
Boîte supplémentaire tendons	236
Boîtes de stérilisation	229
Boîtes en métal	228-229
BOWMAN Stylets	49
BOYNTON Porte-aiguille	60
BRAND Décolleurs de tendons	195, 196
BRAND Pince conductrice pour tendons	193
BROWN Porte-aiguille	57
BROWN-ADSON Pincés	35
BRÜSER-KELLY Ciseaux à préparations	24
BUCK-GRAMCKO Levier à os	176

BUCKLEY Ciseaux burins et gouges	128
BUNNELL Conducteurs de tendons	194
BUNNELL Décolleurs de tendons	195
BUNNELL Perforateur à main	168
BUNNELL Stylet	50

C

Cadres de rangement pour micro-instruments	230
Cadres de rangement	230
Cadres de stérilisation pour instruments micro	230
Canule de lavage pour scie micro	183
CAROLL Pincés pour saisir les tendons	192
CASTROVIEJO Compas	220
CASTROVIEJO Micro-Ciseaux	32
CASTROVIEJO Micro-Porte-aiguilles	61
CASTROVIEJO Pincés à sutures	68
CHAMPIONNIERE	
Perforateur à main	171
Chirurgie de haute-fréquence	201-204
Cisaille à os	144
Ciseaux	9-32
Ciseaux à cartilages	28
Ciseaux à ligatures	69
Ciseaux à ongles	190
Ciseaux à pansements	222
Ciseaux à plâtres	223
Ciseaux à préparations	19-27
Ciseaux à tissus	28
Ciseaux burins	123-129
Ciseaux burins et gouges	126-129
Ciseaux burins pour hémostase	129
Ciseaux chirurgicaux	17-18
Ciseaux coupe-fil	156-157
Ciseaux fins	9-16
Ciseaux tunnellation	11, 12
Clamps atraumatiques	73, 75
Clamps Bulldog	73
Clamps vasculaires	79-80, 82-84
Clé de remplacement pour approximateur	82
Clé pour approximateur	82
Clés pour scie à plâtre	226
Clés de remplacement pour perforateurs	167, 168, 169, 170
Clés de remplacement pour scies micro	178, 180, 182
Clés pour scies micro	178, 180, 182
Clés pour trépan à main	167, 168, 169, 170
Clous médullaires et accessoires	145-147
COLLIN Dynamomètre	218
Compas	220
Conducteurs de tendons	194
Container (Indication)	231
Container pour ostéotomes	132
CONVERSE Porte-aiguille	55
CONVERSE Râpe à os	106
COPE Ecarteur	90
COTTLE Ecarteurs	95, 100
COTTLE Elévateurs	113
COTTLE "HM" Râpe à os	107
COTTLE-MEDICON Ciseaux-burins	127
CRILE WOOD Porte-aiguilles	58
CRILE WOOD BABY Porte-aiguille	58
Crochets vasculaires	93
Crochets	100
Curette à os	120
Curettes tranchantes	133-136
CUSHING Ecarteur	92, 93
CUSHING Pincés anatomiques	39

D

Daviers à os	137-144
DEBAKEY Pincés atraumatiques	38
DEBAKEY "AT" Pincés hémostatiques	73
Décolleur de tendons	195-196
DELIMA-HARDT Ciseaux burins	125
DERF-CONVERSE Porte-aiguille	57
DERF WRIGHT Porte-aiguilles	57
Dermatomes	5-8
DESCHAMPS	
Sonde conductrice cannelée	66
DESCHAMPS-BABY Aiguilles à ligatures	65
DESMARRES Ecarteurs	99
DIEFFENBACH Pincés hémostatiques	73
DIETHRICH Pincés hémostatiques	72
DINGMAN Daviers à os	143
Disque excentrique pour lames de scie	226
Disque pour lames de scie	226
Dissecteurs	120
Distributeurs de forets filiformes	154
DOYEN Maillet	122
Dynamomètre	218

E

Ecarteurs	89-100
Ecarteurs à doigts	104
Ecarteurs à nerfs	93
Ecarteurs autostatiques	101-104
Ecarteurs/crochets	94-95
Elévateurs	111-113
Etiquette "SHEPARD OSTEOTOM" pour MEDICONTAINER	132
Etriers à extension	163-164
Etriers à extension pour doigts	163-164
Etuis	228-229
Etui pour lunettes à loupe	213
EXCENTRIC-LISTER	
Ciseaux à pansements	222

F

FANOUS Ciseaux à préparations	27
Fils d'acier à os	149-150
FINSEN Ecarteur	102
FINSEN MODIF. Ecarteur	102
FISCHER Décolleurs de tendons	195
FOMON Ciseaux	16
FOMON Ecarteur	100
FOMON "HM" Râpe à os	109
Forets (ostéosynthèse)	191, 203
Forets filiformes	151-153
FOX Pince pour saisir tissus et cartilages	40
Fraises en spirale pour perforateurs à main	171
Fraises	171
FRAMER Conducteurs de tendons	194
FRAMER Etriers à extension	164
FRAZIER Ecarteurs	94
FRAZIER Instruments à aspiration	52
FREER Ciseaux burins	128
FREER Ecarteurs	96
FREER Elévateurs	112
FRIEDMANN Pince-gouge	138

G

GALLAHER Râpes à os	107
GERALD Pincés anatomiques	39
GILLIES Ecarteurs	94
GILLIES Pince	37

GILLIES OBWEGESER Porte-aiguille	54-55
GOLDSTEIN LOGAN	
Ecarteur autostatique	103
Goniomètre	219
GRAEFE Ecarteurs	99
GRAEFE Pincés à tissus	40
GRAEFE ADSON Pince	35
GRAMCKO-BUCK Leviers à os	176
GREEN Pincés à saisir tissus	40
GREEN-LANGENBECK Ecarteurs	91
GREEN-SENN Ecarteurs	91
GREENBERG PAR (SHEA)	
Ciseaux à préparations	19
GROSS Pincés à pansements	88
GUTHRIE Crochet	96

H

HACKSTOCK Pince pour l'extraction	162
HAJEK Maillet	122
HAJEK-BALLENGER Elévateur	113
HALSEY Porte-aiguilles	56
HALSTED-MEDICON Porte-aiguille	54
HALSTED-MICRO Pincés hémostatiques	74
HALSTED-MOSQUITO	
Pincés hémostatiques	75
HARDT-DELIMA Ciseaux burins	125
HARTMANN (BABY MOSQUITO)	
Pincés hémostatiques	74
HEGAR MAYO Porte-aiguilles	57
HEGAR OLSEN Porte-aiguilles	59
HENTON Aiguilles à ligatures	65
HINDERER Pince pour saisir cartilages	40
"HM" Ciseaux	13, 17-18, 20-23
"HM" Ciseaux coupe-fil	156-157
"HM" Pincés anatomiques/ chirurgicales	34,38-39
"HM" Pincés coupantes	158
"HM" Pincés serre-fil	161
"HM" Porte-aiguilles	54-61
"HM" Râpes à os	107,109
HUMBY Dermatome	6
HUMBY Ecarteurs	94
HYLIN Rugine	117

I

Impacteur pour clous médullaires	147
Impacteur-extracteur pour clous médullaires	147
Instrument à tunnellation	194
Instruments à aspiration	51-52
Instruments à ongles	187-190
Instruments à pansements et à plâtre	221-226
Instruments à sutures	53-69
Instruments de mesure	217-220
Instruments pour fils métalliques	155-162
Instruments pour tendons	191-197
Interrupteur à pédale pour appareil HF	203
IRIS Ciseaux	12-13
IRIS Pincés	36

J

JABELEY Ciseaux	11
JACKSON Ecarteurs	90
JACKSON OMBREDANNE	
Pince pour saisir les tendons	192
JACOBSON Micro-Pincés	45
JACOBSON Micro-Porte-aiguilles	61
JACOBSON-ADSON Micro-Pincés	45

JACOBSON-MICRO	
Pincés hémostatiques	74
JAMESON Pied à coulisse	219
JAMESON REYNOLDS	
Ciseaux à préparations	26-27
JANSEN-ZAUFAL Pincés gouges	140
JOHNS-HOPKINS Clamps hémostatiques	73
JOSEPH Ciseaux	16
JOSEPH Ecarteurs	95
JOSEPH Instrument-mesureur	220
JOSEPH Râpe à os	106
JOSEPH Rugine	116
JOSEPH Scie	184

K

KAHRE-WILLIGER Rugines	115
KELLY Pincés hémostatiques	75
KELLY-BRÜSER Ciseaux à préparations	24
KERN Daviers à os	143
KILNER RAGNELL	
Ciseaux à préparations	19
KIRSCHNER Forets filiformes	151-153
KISTNER Stylets	50
KLEINERT-KUTZ Ecarteurs	95
KLEINERT-KUTZ Pincés à os	141
KLEINERT-KUTZ	
Pincés conductrices pour tendons	193
KLEINERT-KUTZ Pincés gouges	139, 140
KNAPP Ciseaux	13
KNAPP Ecarteurs	96
KOCHER Pincés hémostatiques	76
KOCHER MATHIEU Porte-aiguilles	60
KOENIG Ecarteurs	92
KOENIG Sondes conductrices	66
Komprimeter	205-206
KUTZ KLEINERT Pince à os	141
KUTZ KLEINERT	
Pincés conductrices pour tendons	193
KUTZ KLEINERT Ecarteurs	95
KUTZ KLEINERT Pincés gouges	139, 140

L

LAHEY CLINIC Ecarteur	94
LAMBOTTE MINI Ciseaux burins	124
Lames de bistouri	2
Lames de rechange (Dermatomes)	6-8
Lames de scie circulaires	226
Lames de scie pour scie à plâtre	226
Lames de scie	179, 181, 183, 185, 226
LANGENBECK Ecarteurs	99
LANGENBECK Scie	184
LANGENBECK-GREEN Ecarteur	91
LANZ MOD. Alène à os	174
LANZ MOD. Davier à os	142
LANZ MOD. Découleurs de tendons	196
LANZ MOD. Dissecteur	120
LANZ MOD. Ecarteur	91, 96
LANZ MOD. Rugine	117
LANZ MOD. Stylet	50
LARSEN	
Pincés à préhension pour tendons	192
LEMPERT Curettes tranchantes	135
LEMPERT Pincés gouges	139
LEMPERT Rugines	116
LERICHE Pincés hémostatiques	75
Leviers à os	175-176
LEWIS "HM" Râpe à os	107
LEXER MINI Ciseaux burins et gouges	129
Limes à os	105-106
LISTER "Supercut"	
Ciseaux à pansements	222

LISTER Ciseaux à pansements	222
LISTER-EXCENTRIC	
Ciseaux à pansements	222
LISTON LITTAUER Pince à os	141
LISTON-MINI Pincés à os	141
LISTON-RUSKIN Pince à os	141
LITTAUER Ciseaux à ligatures	69
LITTAUER-LISTON Pince à os	141
LITTLE Ecarteur	92
LITTLER Ciseaux	16
LOCKLIN Ciseaux à tissus	28
LOGAN (GOLDSTEIN)	
Ecarteur autostatique	103
Loupes frontales binoculaires	214-215
Loupes frontales, Lunettes à loupe	211-215
LUCAE Ecarteurs	93
LUER Ecarteurs	90
LUER Pince gouge	138
LUKENS Ecarteurs	90
Lunettes à loupe, Loupes frontales	211-215

M

MACDONALD Dissecteur	120
MACHATT Ecarteur	96
MAIER Pincés à pansements	88
Maillets	121-122
MALTZ Râpe à os	107
Manches à perforer	167
Manches pour bistouris	3
MARKWALDER Pincés à os	141
MARTIN Ciseaux à cartilages	28
MARTINI Curettes tranchantes	136
MASING Lime à os	106
MASING Râpe à os	107
MATHIEU Ecarteurs	90
MATHIEU Rugine	116
MATHIEU-KOCHER Porte-aiguilles	60
MAYO-HEGAR Porte-aiguilles	57
MCINDOE Pince	37
MCINDOE-MEDICON Pince à os	141
MCKENTY Rugines	115
MCPHERSON Pincés à sutures	68
MCPHERSON VANNAS Micro-ciseaux	32
MEDICON Ecarteurs autostatiques	103
MEDICON Maillet	122
MEDICON Pincés serre-fils	161
MEDICON-BIPOLAR Coagulateur	202
MEDICON-HALSTED Porte-aiguille	54
MEDICON MCINDOE Pince à os	141
MEDICONTAINER (Indication)	231
METZENBAUM Ciseaux à préparations	21-24
METZENBAUM-BABY	
Ciseaux à préparations	21
METZENBAUM-SLIM Ciseaux à prép.	23
MEYERDING Ecarteurs	91
MICRO 2000 Ciseaux	29-30
MICRO 2000 Pincés à sutures	67
MICRO 2000 Pincés	41-44
MICRO 2000 Porte-aiguilles	62-63
Micro ciseaux	12, 29-32
Micro clamps	79-80, 82-84
Micro coagulateur bipolaire	202
Micro Pincés	41-45
Micro porte-aiguilles	61-64
Micro rugines	118
Micro scie à guichet	182-183
Micro scie oscillante	178-179
Micro scie Osseoscalpel	180-181
Micro scies	178-183
MICRO-ADSON Pincés	35
MICRO-HALSTED Pincés hémostatiques	74
MICRO-HARTMANN	
Pincés hémostatiques	74

MICRO JACOBSON Pincés hémostatiques	74	Pincés à os	141	SCHWARZ Etrier à extension	164
MILLARD (COTTLE) Crochet	100	Pincés à pansements	87-88	Scie à guichet	182-183
MILLER Curette à os	120	Pincés à préparations	77	Scie à plâtre électrique	224-226
MILLER Limes à os	106	Pincés à sutures	67-68	Scie électrique à plâtres et accessoires	224-226
MINI-LAMBOTTE Ciseaux burins	124	Pincés anatomiques	34-39	Scie micro oscillante	178-179
MINI-LEXER Ciseaux burins et gouges	129	Pincés atraumatiques	38	Scies pour couper les bagues	185
MINI-LISTON Pince à os	141	Pincés bipolaires	204	Scies	177-186
MINI-RUSKIN Pincés gouges	140	Pincés chirurgicales	34-39	SEBILEAU Elévateur	112
MINI-RYDER Porte-aiguilles	58	Pincés conductrices tendons	193	SELECT Pincés	37
MIXTER-BABY Pince à préparations	77	Pincés coupantes	158-160	SEMKEN Pincés	36
MOBERG Ciseaux burins	127	Pincés de reposition	142	SENN-GREEN Ecarteurs	91
MOLDESTAD Ecarteur	93	Pincés fines	34-37	SENN-MILLER Ecarteurs	90
MOLT Rugines	114	Pincés gouges	138-140	SENNING Porte-aiguille	59
MOSQUITO "AT" Pincés hémostatiques	75	Pincés hémostatiques	72-77, 79-80, 82-84	S.G.H. Pince gouge	138
MOSQUITO HALSTED Pincés hémostatiques	75	Pincés porte-tampons	88	SHEA GREENBERG PAR Ciseaux à préparations	19
MUCK Périostome	120	Pincés pour entrelacer les tendons	197	SHEEHAN Ciseaux burins	126
N		Pincés pour extraire fil d'acier	161, 162	SHEEHAN Gouges	127
NEIVERT Porte-aiguille	56	Pincés pour extraire	161, 162	SHEPARD	
NEWS Ecarteur	94	Pincés pour poser les clips	81-85	Ostéotomes et accessoires	130-132
NIRO Pince à os	141	Pincés pour saisir cartilages	40	SLIM Ciseaux à préparations	20, 23
NIRO Pincés serre-fils	161	Pincés pour saisir les tendons	192	SMEDBERG Perforateur à main	170
O		Pincés pour saisir les tissus	40, 199-200	Sondes conductrices cannelées	66
Objectifs supplémentaires pour lunettes à loupes	212	Pincés pour saisir	40	SPENCER Ciseaux à ligatures	69
OBWEGESER Ostéotome	129	Pincés serre-fil pointues	162	SPRATT Curettes tranchantes	135
OBWEGESER Pince à courber les fils	161	Pincés serre-fil	161	STANDARD Pince anatomique	38
OBWEGESER Pincés coupantes	160	Pincés vasculaires	39	STEINMANN	
OBWEGESER Pincés serre-fil	162	Plaques pour tendre la peau (dermatomes)	7	Pincés à préhension tendons	192
OBWEGESER Râpes à os	108	Porte-aiguilles "HM"	54-61	STELLBRINK Pincés gouges	139
OBWEGESER Rugines	118	Porte-aiguilles	54-64	STEVENS Ciseaux	14-15, 25
OBWEGESER-GILLIES		POTTS SMITH Pince anatomique	38	STEVENSON Ecarteur autostatique	103
Porte-aiguilles	54-55	Propositions de boîtes pour la chirurgie de la main	233-239	STILLE Ciseaux burins et gouges	128
OCHSNER ROCHESTER		PROVIDENCE-HOSPITAL		STILLE-MINI Cisaille à plâtre	223
Pincés hémostatiques	76	Pincés hémostatiques	75	STILLE-STRANDELL Ecarteur	92
OLSEN-HEGAR Porte-aiguille	59	PYNCHON ANDREWS		STRAIGHT Ecarteur	94
OLSEN-HEGAR-MINI Porte-aiguille	59	Instrument à aspirations	52	STRANDELL-STILLE Ecarteur	92
OMBREDANNE (JACKSON) Pince à saisir les tendons	192	R		Stylets	47-50
Osseoscalpel Scie micro	180-181	RADOLF Pince pour arracher les ongles	189	"Supercut" Ciseaux	10-11, 14-18, 21-25, 27
Ostéosynthèse (Indication au système)	242	RAGNELL Ecarteur	90	"Supercut" Ciseaux à pansements	222
Ostéotome	129, 130	RAGNELL (KILNER)		"Supercut plus" Ciseaux	13-14, 19-23
Ostéotomes cylindriques et accessoires	130-132	Ciseaux à préparations	19	T	
P		RALK Perforateur à main	169	Tapis silicone pour ostéotome Shepard	132
PEAN Pincés hémostatiques	76	Râpe pour scie micro	183	TRAUTMANN Gouges	126
Perforateur à ongles	188	Râpes à os	107-109	Trépan à main	171
Perforateurs	165-171	Règles	218, 220	TYRELL Ecarteur	99
Perforateurs à main	168-170	Règles en acier	218	U	
Périostome	120	REYNOLDS (JAMESON)		ULRICH Daviers à os	144
PERTHES Alésoir	174	Ciseaux à préparations	26-27	ULRICH Pincés porte-tampons	88
Pièce à main angulaire pour broches	166	ROCHESTER-OCHSNER		UNIVERSAL Ciseaux coupe-fil	156
Pieds à coulisse	219	Pincés hémostatiques	76	V	
Pince atraumatique pour saisir les tissus	200	ROCHESTER-PEAN		Valves centrales pour écarteurs	103
Pince atraumatique pour tendons	192	Pincés hémostatiques	76	VANNAS Micro-ciseaux	31-32
Pince pour arracher les ongles	189	ROLLET Ecarteur	96	VANNAS MCPHERSON Micro-ciseaux	32
Pince pour arracher les plâtres	223	ROSE Ecarteur	91	VERBRUGGE Daviers à os	144
Pince pour extraire le fil d'acier à os	162	Ruban métrique	218	VOLKMANN Curettes tranchantes	135
Pince pour fendre les ongles	189	Ruban métrique en acier	218	W	
Pince pour phalanges	142	Rugines	114-118	WAGNER Ciseaux	10, 11
Pince-dilatateur vasculaire	85	RUSKIN-LISTON Pince à os	141	WALTER Curette tranchante	136
Pincés	33-45	RUSKIN-MINI Pincés gouges	140	WALTER Instruments à aspiration	52
Pincés à champs	77	RYDER (FRENCH EYE) Porte-aiguilles	58	WALTER WILLIGER Curette tranchante	136
Pincés à courber les fils	161	RYDER-MINI Porte-aiguilles	58	WARD Rugine	116
Pincés à ligatures	77	S		WEBSTER Porte-aiguille	56
Pincés à ongles	189	SACHSE Osseoscalpel	180-181		
		SACHSE Scie micro oscillante	178-179		
		SCHINK Dermatome	7		
		SCHUCHARDT Cisaille à os	144		
		SCHUKNECHT Ciseaux coupe-fil	156		
		SCHUKNECHT BARON			
		Instrument à aspiration	52		

WECKER Micro-ciseaux	32
WEITLANER Ecarteurs autostatiques	104
WEST Ciseaux burins et gouges	128
WIBERG Rugines	116
WILLIGER Curettes tranchantes	136
WILLIGER Élévateurs	112
WILLIGER Rugines	115
WILLIGER KAHRE Rugines	115
WILLIGER-WALTER Curettes tranchantes	136
WOLFF-BOEHLER	
Pince pour arracher les plâtres	223
WRIGHT (DERF) Porte-aiguille	57

Y

YASARGIL Ciseaux	31
YASARGIL Micro clamps vasculaires	84
YASARGIL Micro pinces	45
YASARGIL Micro porte-aiguilles	62
YASARGIL Pince pour poser les clips	85
YASARGIL Rugine	118

Z

ZAUFAL-JANSEN Pince gouge	140
---------------------------	-----

(Faint mirrored text from the reverse side of the page)

(Faint mirrored text from the reverse side of the page)

A

(Faint mirrored text from the reverse side of the page)

A

ACLAND Approssimatore	80
ACLAND Micro Pinze Vascolari	80
ACLAND Pinze per applicare clips	81
ADLERKREUTZ Pinza per vasi	39
ADSON Pinze	34
ADSON Pinze per sutura	67
ADSON-BABY Pinze per preparazione	77
ADSON-BROWN Pinze	35
ADSON-GRAEFE Pinze	35
ADSON-JACOBSON Micro Pinze	45
ADSON-MICRO Pinze	35
Aghi per legatura	65
AGRICOLA Divaricatori Autostatici	103
Alesatori	173-174
ALLIS Pinze per afferrare tessuti	200
ALLIS-BABY	
Pinze per afferrare tessuti	200
ALM Divaricatori autostatici	103
ANDREWS PYNCHON	
Strumenti per aspirazione	52
Anelli di gomma per mani di piombo	209
Apparecchiatura	165-171
Apparecchio per coagulazione bipolare e accessori	202-203
Approssimatore con chiave	82
Approssimatore	80, 82-83
ARRUGA Port'aghi	60
Astucci	228-229
Astucci per sterilizzazione	229
Astuccio per occhiali d'ingrandimento	213
AUFRIEHT Forbici	16

B

BABY-ALLIS Pinze per afferrare tessuti	200
BABY-CRILE-WOOD Port'aghi	58
BABY-METZENBAUM	
Forbici per preparazione	21
BABY MOSQUITO HARTMANN	
Pinze emostatiche	74
BACKHAUS Fissateli	77
BALLENGER HAJEK Elevatori	113
BARON (SCHUKNECHT)	
Cannula per aspirazione	52
BARRAQUER Micro Port'aghi	61
BARSKY Divaricatori	94
BEEBEE	
Forbici per tagliare filo d'acciaio	157
BERGMANN Divaricatori	95
BEYER Pinze Sgorbie	138, 140
BIEMER Approssimatore	82-83
BIEMER Micro pinze vascolari	82
BIEMER Pinze per applicare	82-83
Bisturi	1-3
BLACK Lime per ossa	106
BLUMENTHAL Pinze Sgorbie	138
BOEHLER-WOLFF Pinza strappagessi	223
BOWMAN Sonda	49
BOYNTON Port'aghi	60
BRAND Enucleatore per tendini	195, 196
BRAND Pinza passa tendini	193
BROWN Port'aghi	57
BROWN-ADSON Pinze	35
BRÜSER-KELLY	
Forbici per preparazione	24
BUCK-GRAMCKO Elevatore per ossa	176
BUCKLEY Scalpelli e sgorbie	128
Bulldog-Pinze	73
BUNNELL Enucleatori per tendini	195
BUNNELL Guida tendini	194
BUNNELL Sonda	50
BUNNELL Trapani a mano	168

C

Calibro micrometrico	219
Cannula per lavaggio di ricambioper micro sega	183
Cannula per lavaggio per Micro Sega	183
CAROLL Pinza da presa per tentini	192
CASTROVIEJO Compasso	220
CASTROVIEJO Micro forbici	32
CASTROVIEJO Micro port'aghi	61
CASTROVIEJO Pinze per sutura	68
Cesoia per gessi	223
Cesoia per ossa	144
Cestello(Indicato)	231
CHAMPIONNIERE	
Perforatori a mano	171
Chiave di ricambio per approssimatore	82
Chiavi per Trapani a mano	167, 168, 169, 170
Chiavi per micro seghe	178, 180, 182
Chiavi per sega da gessi	226
Chiodi midollari ed accessori	145-147
Chiodi midollari ad uncino	146
Chirurgia ad alta frequenza	201-204
Coagulatore bipolare	202
COLLIN Dinamometro	218
Cottello staccaperiosto	120
Compasso	220
Contentore per sterilizzazione per Osteotomi cilindrici	132
Contentori per sterilizzazione (Indicati)	231
CONVERSE Lime per ossa	106
CONVERSE Port'aghi	55
COPE Divaricatori	90
COTTLE Divaricatori	95, 100
COTTLE Elevatori	113
COTTLE "HM" Raspe per ossa	107
COTTLE MEDICON Scalpello	127
CRILE WOOD Port'aghi	58
CRILE WOOD BABY Port'aghi	58
Cucchiari taglienti	133-136
Cucchiario ossivero	120
CUSHING Divaricatori	92, 93
CUSHING Pinze anatomiche	39

D

DEBAKEY Pinze Atraumatiche	38
DEBAKEY Pinze emostatiche"AT"	73
DELIMA-HARDT Scalpelli	125
DERF-CONVERSE Port'aghi	57
DERF WRIGHT Port'aghi	57
Dermatomi	5-8
DESCHAMPS	
Sonde conduttrici scanal.	66
DESCHAMPS-BABY	
Aghi per legatura	65
DESMARRES Divaricatori	99
DIEFFENBACH	
Pinze emostatiche	73
DIETHRICH	
Pinze emostatiche	72
Dinamometro	218
DINGMAN	
Pinza afferra ossa	143
Disco eccentrico per lame da gesso	226
Disco per lame da sega da gessi	226
Dissettori	120
Distributore di fili	154
Divaricatori autostatici	101-104
Divaricatori per le dita	104
Divaricatori	89-100
DOYEN Martelli	122

E

Elevatori per ossa	175-176
Elevatori	111-113
Emostatiche	72-77, 79-80, 82-84
Enucleatore per tendini	195-196
Etichetta d'identificazione "SHEPARD OSTEOTOM" per MEDICONTAINER	132
EXCENTRIC-LISTER	
Forbici per bendaggi	222

F

FANOUS Forbici per preparazione	27
Filo d'acciaio per ossa	149-150
FINSEN Divaricatori autostatici	102
FINSEN MODIF. Divaricatori autostatici	102
FISCHER Enucleatore per tendini	195
Fissateli	77
FOMON Divaricatori	100
FOMON Forbici	16
FOMON Raspe per ossa "HM"	109
Forbici	9-32
Forbici chirurgiche	17-18
Forbici delicate	9-16
Forbici per bendaggi	222
Forbici per cartilagine	28
Forbici per legature	69
Forbici per preparazione	19-27
Forbici per scalzare unghie	190
Forbici per tagliare fili d'acciaio	156-157
Forbici per tagliare fili	156-157
Forbici per tessuti	28
Forbici per tunnelizzare	11, 12
Forbici per unghie	218
FOX Pinza per afferrare tessuti e cartilagine	40
FRAMER Guida tendini	194
FRAMER Staffe per le dita	164
FRAZIER Divaricatori	94
FRAZIER Strumenti per aspirazione	52
FREER Divaricatori	96
FREER Elevatori	112
FREER Scalpelli	128
FRIEDMANN Pinze Sgorbie	138

G

GALLAHER Raspe per ossa	107
GERALD Pinze anatomiche	39
GILLIES Divaricatori	94
GILLIES Pinze	37
GILLIES OBWEGESER Port'aghi	54-55
GOLDSTEIN LOGAN Divaricatori autos.	103
Goniometro per le dita	219
Goniometro	219
GRAEFE Divaricatori	99
GRAEFE Pinze per afferrare tessuti	40
GRAEFE ADSON Pinze	35
GRAMCKO-BUCK Elevatori per ossa	176
GREEN Pinze per afferrare tessuti	40
GREEN-LANGENBECK Divaricatori	91
GREEN-SENN Divaricatori	91
GREENBERG PAR (SHEA)	
Forbici per preparazione	19
GROSS Pinza per medicazione	88
Guida tendini	194
GUTHRIE Divaricatori	96

H

HACKSTOCK	
Pinza per estrarre fili-per ossa.	162

HAJEK Martello	122	Komprimeter	205-206	MATHIEU Divaricatore	90
HAJEK-BALLENGER Elevatori	113	KUTZ KLEINERT Pinza passa tendini	221	MATHIEU Periostotomo	116
HALSEY Port'aghi	56	KUTZ KLEINERT Pinze ossivore	141	MATHIEU-KOCHER Port'aghi	60
HALSTED-MEDICON Port'aghi	54	KUTZ KLEINERT Divaricatori	95	MAYO-HEGAR Port'aghi	57
HALSTED-MICRO Pinze emostatiche	74	KUTZ KLEINERT Pinze sgorbie	139, 140	MCINDOE Pinza	37
HALSTED-MOSQUITO Pinze emostatiche	75			MCINDOE-MEDICON Pinza ossivora	141
HARDT-DELIMA Scalpelli	125	L		MCKENTY Periostotomi	115
HARTMANN (BABY MOSQUITO) Pinze emostatiche	74	LAHEY CLINIC Divaricatore	94	MCPHERSON Pinze per sutura	68
HEGAR MAYO Port'aghi	57	LAMBOTTE MINI scalpelli	124	MCPHERSON VANNAS Micro forbici	32
HEGAR OLSEN Port'aghi	59	Lame circolari per sega per bendaggi gessati	226	MEDICON Divaricatore autostatico	103
HENTON Aghi per legatura	65	Lame da sega	179, 181, 183, 185, 226	MEDICON Martello	122
HINDERER Pinze per cartilagine	40	Lame di ricambio per sega	179, 181, 183, 185, 226	MEDICON Pinze tendifili d'acciaio	161
"HM" Forbici	13, 17-18, 20-23	Lame di ricambio (Dermotomo)	6-8	MEDICON-BIPOLAR	
"HM" Forbici per fili d'acciaio	156-157	Lame per sega da gessi	226	Apparecchio per coagulazione	202
"HM" Pinza tendi fili d'acciaio	161	Lame sterili per bisturi	2	MEDICON-HALSTED Port'aghi	54
"HM" Pinze	34, 38-39	LANGENBECK Divaricatore	99	MEDICON MCINDOE Pinza ossivora	141
"HM" Port'aghi	54-61	LANGENBECK Segra	184	MEDICONTAINER	
"HM" Raspe per ossa	107,109	LANGENBECK-GREEN Divaricatore	91	(informazione generale)	231
"HM" Tronchese per fili d'acciaio	158	LANZ MOD. Dissettore	120	METZENBAUM	
HUMBY Dermatomo	6	LANZ MOD. Divaricatore	91, 96	Forbici per preparazione	21-24
HUMBY Divaricatori	94	LANZ MOD. Enucleatore per tendini	196	METZENBAUM-BABY	
HYLIN Periostotomi	117	LANZ MOD. Periostotomo	117	Forbici per preparazione	21
		LANZ MOD. Pinza afferra ossa	142	METZENBAUM-SLIM	
I		LANZ MOD. Puntaruoli	174	Forbici per preparazione	23
Interruttore a pedale per appar. bip.	203	LANZ MOD. Sonde	50	MEYERDING Divaricatore	91
Introduttore di chiodi midollari	147	LARSEN Pinza per afferrare tendini	192	MICRO 2000 Forbici	29-30
IRIS Forbici	12-13	LEMPERT Cucchiali taglienti	135	MICRO 2000 Pinze per sutura	67
IRIS Pinze	36	LEMPERT Periostotomi	116	MICRO 2000 Pinze	41-44
		LEMPERT Pinze sgorbie	139	MICRO 2000 Port'aghi	62-63
J		Lente frontale binoculare	214-215	Micro Apparecchio per coagulazione, bipolare	202
JABELEY Forbici	11	Lente frontale binoculare	214-215	Micro Forbici	12, 29-32
JACKSON Divaricatori	90	Lente frontale Occhiali d'ingrand.	211-215	Micro Pinze	41-45
JACKSON OMBREDANNE Pinza afferra tendini	192	LERICHE Pinze emostatiche	75	Micro Pinze vascolari	79-80, 82-84
JACOBSON Micro pinze	45	LEWIS "HM" Raspa per ossa	107	Micro Port'aghi	61-64
JACOBSON Micro port'aghi	61	LEXER MINI Scalpelli e Sgorbie	129	Micro sega a coda	182-183
JACOBSON-ADSON Micro pinze	45	Lime per ossa	105-106	Micro sega oscillante	178-179
JACOBSON-MICRO Pinze emostatiche	74	LISTER "Supercut" Forbici per bendaggi	222	Micro sega	178-183
JAMESON Calibro micrometrico	219	LISTER Forbici per bendaggi	222	MICRO-ADSON Pinze	35
JAMESON REYNOLDS Forbici per preparazione	26-27	LISTER-EXCENTRIC Forbici per bendaggi	222	MICRO-HALSTED Pinze emostatiche	74
JANSEN-ZAUFAL Pinze sgorbie	140	LISTON LITTAUER Pinze ossivore	141	MICRO-HARTMANN Pinze emostatiche	74
JOHNS-HOPKINS Pinze emostatiche	73	LISTON-MINI Pinze ossivore	141	MICRO JACOBSON Pinze emostatiche	74
JOSEPH Asta graduata	220	LISTON-RUSKIN Pinza ossivora	141	Micro-Periostotomo	118
JOSEPH Divaricatori	95	LITTAUER Forbici per legature	69	MILLARD (COTTLE)	
JOSEPH Forbici	16	LITTAUER-LISTON Pinza ossivora	141	Uncino nasale a forma d'anello	100
JOSEPH Lime per ossa	106	LITTLE Divaricatore	92	MILLER Cucchiao ossivoro	120
JOSEPH Periostotomi	116	LITTLER Forbice	16	MILLER Lima per ossa	106
JOSEPH Seghe	184	LOCKLIN Forbici per cartilagine	28	MINI-LAMBOTTE Scalpelli	124
		LOGAN (GOLDSTEIN) Divaricatore	103	MINI-LEXER Scalpelli e Sgorbie	129
K		LUCAE Divaricatore	93	MINI-LISTON Pinza ossivora	141
KAHRE-WILLIGER Periostotomi	115	LUER Divaricatore	90	MINI-RUSKIN Pinza sgorbia	140
KELLY Pinze emostatiche	75	LUER Pinza Sgorbie	138	MINI-RYDER Port'aghi	58
KELLY-BRÜSER Forbici per preparazione	24	LUKENS Divaricatore	90	MIXER-BABY Pinza per preparazione	77
KERN Pinza afferra ossa	143			MOBERG Scalpelli	127
KILNER RAGNELL Forbici per preparazione	19	M		MOLDESTAD Divaricatore	93
KIRSCHNER Punte filiforme	151-153	MACDONALD Dissettore	120	MOLT Periostotomo	114
KISTNER Sonde	50	MACHATT Divaricatore	96	MOSQUITO "AT" Pinze emostatiche	75
KLEINERT-KUTZ Pinza passa tendini	193	MAIER Pinza per medicatura	88	MOSQUITO HALSTED Pinze emostatiche	75
KLEINERT-KUTZ Pinze ossivore	141	MALTZ Raspa per ossa	107	MUCK Coltello staccaperiosto	120
KLEINERT-KUTZ Pinze sgorbie	139, 140	Mani di piombo	207-209		
KLEINERT-KUTZ Divaricatori	95	Manici per bisturi	3	N	
KNAPP Divaricatori	96	Manici per perforatori	167	Nastro metrico di tela	218
KNAPP Forbici	13	Manipolo angolato per perf.filif.	166	Nastro metrico	218
KOCHER Pinze emostatiche	76	MARKWALDER Pinza ossivora	141	NEIVERT Port'aghi	56
KOCHER MATHIEU Port'aghi	60	Martelli	121-122	NEWS Divaricatore	94
KOENIG Divaricatori	92	MARTINI Forbici per cartilagine	28	NIRO Pinza ossivora	141
KOENIG Sonde conduttrici scanalate	66	MARTINI Cucchiali taglienti	136	NIRO Pinza tendifili d'acciaio	161
		MASING Lima per ossa	106	O	
		MASING Raspa per ossa	107	Obiettivi addizionali per Occhiali d'ing.	212
				OBWEGESER Osteotomo	129

OBWEGESER Periostotomi	118	Port'aghi	54-64	SLIM Forbici per preparazione	20, 23
OBWEGESER Pinze appuntite per fili	162	Port'aghi "HM"	54-61	SMEDBERG Trapano a mano	170
OBWEGESER Pinze a punte piatte	161	POTTS SMITH Pinza anatomica	38	Sonde	47-50
OBWEGESER Raspe per ossa	108	Proposte di set di chirurgia della mano	233-239	Sonde conduttrici scanalate	66
OBWEGESER Tronchese per fili d'acciaio	160	PROVIDENCE-HOSPITAL		Sonde scanalate	48
OBWEGESER-GILLIES		Pinze emostatiche	75	SPENCER Forbici per legature	69
Port'aghi	54-55	Puntaruoli	173-174	SPRATT Cucchiali taglienti	135
Occhiali d'ingrandimento	211-215	Punte filiforme	151-153	Staffa per le dita	163-164
OCHSNER ROCHESTER		Punteruoli per chiodi midollari	147	Staffa	163-164
Pinze emostatiche	76	PYNCHON ANDREWS		STANDARD Pinze anatomiche	38
OLSEN-HEGAR		Strumenti per aspirazione	52	STEINMANN	
Port'aghi	59	R		Pinze da presa per tendini	192
OLSEN-HEGAR-MINI		RADOLF Pinza per togliere unghie	189	STELLBRINK Pinze sgorbie	139
Port'aghi	59	RAGNELL (KILNER)		STEVENS Forbici	14-15, 25
OMBREDANNE (JACKSON)		Forbici per preparazione	19	STEVENSON	
Pinza per afferrare tendini	192	RAGNELL Divaricatore	90	Divaricatori autostatici	103
Osteosintesi sistema (indicazione)	242	RALK Trapani a mano	169	STILLE Scalpelli e sgorbie	128
Osteotomi cilindrici e accessori	130-132	Raspa al tungsteno per Micro sega	183	STILLE-MINI Cesoi per gessi	223
Osteotomi	123-129	Raspe per ossa	107-109	STILLE-STRANDELL Divaricatori	92
Osteotomi	129, 130	Rastrelliera per microstrumenti	230	Stoia a grumelli in silicone per Shepard Osteotomi	132
P		REYNOLDS (JAMESON)		STRAIGHT Divaricatori	94
PEAN Pinze emostatiche	76	Forbici per preparazione	26-27	STRANDELL-STILLE Divaricatori	92
Perforatore elicoidale per manici	171	Riga graduata	218	Strumenti per aspirazione	51-52
Perforatori	171	Riga	218, 220	Strumenti per bendaggi e gessi	221-226
Perforatori a mano	171	ROCHESTER-OCHSNER		Strumenti per chiodi midollari	147
Periostotomi	114-118	Pinze emostatiche	76	Strumenti per fili d'acciaio	155-162
PERTHES Alesatore	174	ROCHESTER-PEAN Pinze emostatiche	76	Strumenti per la misura	217-220
Piastra per tendere la pelle (p.dermatomo)	7	ROLLET Divaricatori	96	Strumenti per la misura	218
Pinza strappagessi	223	ROSE Divaricatori	91	Strumenti per sutura	53-69
Pinza afferra ossa	142-144	RUSKIN-LISTON Pinze ossivere	141	Strumenti per unghie	187-190
Pinza da presa ed estrazione	161, 162	RUSKIN-MINI Pinze sgorbie	140	Strumento per tendini	191-197
Pinza da presa per falangi	142	RYDER (FRENCH EYE) Port'aghi	58	Strumento traforatore	194
Pinza da presa tendini	192	RYDER-MINI Port'aghi	58	"Supercut" Forbici	10-11, 14-18, 21-25, 27
Pinza passa tendini	193	S		"Supercut" Forbici	
Pinza per cartilagine	40	SACHSE Micro sega oscillante	178-179	per bendaggi	222
Pinza per dilatazione vascolare	85	SACHSE Scalpello osseo	180-181	"Supercut plus" Forbici	13-14, 19-23
Pinza per estrazione fili per ossa	162	Scalpelli	124-129	Supporto per sterilizzazione	
Pinza per preparazione	77	Scalpelli enucleatori per tendini	196	per Micro strumenti	230
Pinza per scalzare unghie	189	Scalpelli per emostasi	129	Supporto	230
Pinza per togliere unghie	189	Scalpello Osseo, micro sega	180-181	T	
Pinze	33-45	Scatole metalliche	228-229	Trapani a mano	168-170
Pinze a punte piatte	161	SCHINK Dermatomo	7	Trapani per unghie	188
Pinze anatomiche	34-39	SCHUCHARDT Cesoi per ossa	144	Trapani	167, 168, 169, 170
Pinze appuntite per fili	162	SCHUKNECHT Forbici per fili d'acciaio	156	TRAUTMANN Sgorbie	126
Pinze atraumatiche	38	SCHUKNECHT BARON		Tronchese per fili d'acciaio	158-160
Pinze bipolari	204	Tubi per aspiraz.	52	TYRELL Divaricatori	99
Pinze chirurgiche	34-39	SCHWARZ Staffa per le dita	164	U	
Pinze da presa atraumatiche	192	SEBILEAU Elevatori	112	ULRICH	
Pinze delicate	34-37	Sega a coda	182-183	Pinze afferra ossa	144
Pinze emostatiche atraumatiche	73, 75	Sega da gessi elettrica	224-226	ULRICH	
Pinze emostatiche	72-76	Sega elettrica da gessi ed accessori	224-226	Pinze per tamponamento	88
Pinze ossivere	141	Seghe per aprire gli anelli	185	Uncini per vene e nervi	93
Pinze per riposizione	142	Seghe	177-186	Uncini per nervi	93
Pinze per afferrare tendini	192	SELECT Pinze	37	Uncini per pelle	94-95
Pinze per afferrare tessuti atraumatiche	200	SEMKEN Pinze	36	Uncini per vene	92-93
Pinze per afferrare tessuti	199-200	SENN-GREEN Divaricatori	91	Uncino per dito a forma d'anello	100
Pinze per afferrare tessuti	40	SENN-MILLER Divaricatori	90	UNIVERSAL Forbici per tagliare fili d'acc.	156
Pinze per applicare Clips	81-85	SENNING Port'aghi	59	V	
Pinze per dilatazione vascolare	85	Set aggiuntivo per tendini	236	Valve centrale per divaricatori autostatici	103
Pinze per estrazione e presa fili	161, 162	Set di aggiunta micro	237	VANNAS Micro forbici	31-32
Pinze per fissaggio	40	Set di aggiunta per ossa	238-239	VANNAS MCPHERSON	
Pinze per intrecciare tendini	197	Set di base p.la chir.della mano	234-235	Micro forbici	32
Pinze per legatura	77	S.G.H. Pinze sgorbie	138	VERBRUGGE	
Pinze per ossa	137-144	SHEA GREENBERG PAR		Pinza afferra ossa	144
Pinze per sutura	67-68	Forbici per preparazione	19	VOLKMANN Cucchiali taglienti	135
Pinze per tamponamento	87-88	SHEEHAN Scalpelli	126		
Pinze per tamponamento	88	SHEEHAN Sgorbie	127		
Pinze per unghie	189	SHEPARD Osteotomi e accessori	130-132		
Pinze sgorbie	138-140				
Pinze tendi fili d'acciaio	161				
Pinze vascolari	39				
Pinze vascolari	79-80, 82-84				

W

WAGNER Forbici	10, 11
WALTER Cucchiai taglienti	136
WALTER Strumenti per aspirazione	52
WALTER WILLIGER Cucchiai taglienti	136
WARD Periostotomi	116
WEBSTER Port'aghi	56
WECKER Micro forbici	32
WEITLANER Divaricatori autostatici	104
WEST Scalpelli e sgorbie	128
WIBERG Periostotomi	116
WILLIGER Cucchiai taglienti	136
WILLIGER Elevatori	112
WILLIGER Periostotomi	115
WILLIGER KAHRE Periostotomi	115
WILLIGER-WALTER Cucchiai taglienti	136
WOLFF-BOEHLER Pinza strappa gessi	223
WRIGHT (DERF) Port'aghi	57

Y

YASARGIL Forbici	31
YASARGIL Micro pinze	45
YASARGIL Micro pinze vascolari	84
YASARGIL Micro port'aghi	62
YASARGIL Periostotomi	118
YASARGIL Pinze per applicare Clip	85

Z

ZAUFAL-JANSEN Pinze sgorbie	140
-----------------------------	-----



zertifiziertes Unternehmen
certified company
compañía certificada
entreprise certifiée
certificazione di compagnia

**MEDICON eG
Germany**

Gänsäcker 15
D-78532 Tuttlingen

Postfach 4455
D-78509 Tuttlingen

Telefon (0 74 62) 20 09-0
Telefax (0 74 62) 20 09-50