



HAUPTKATALOG

GENERAL CATALOGUE



CATALOGO GENERALE

CATÁLOGO GENERAL

1
2
3
4
5
6
7
8
9
10
11
12
13
14
15
16
17
18
19
20
21
22
23
24
25
26
27
28
29



Dieser Hauptkatalog bleibt ausschließliches Eigentum.
Lieferbedingungen finden Sie in unserer jeweilig gültigen Preisliste.

*This General Catalogue remains our exclusive property.
Our "Terms of Sale" are listed in our latest price list.*

Questo catalogo generale rimane esclusivamente di nostra proprietà.
Le condizioni di fornitura sono contenute nell'ultimo listino prezzi.

*Este Catálogo general queda de nuestra exclusiva propiedad.
Nuestras condiciones de venta están incluidas en la lista de precios actual.*

© CEATEC Medizintechnik GmbH & Co. KG - 08/2010
Technische Änderungen vorbehalten.
Gedruckt in der Bundesrepublik Deutschland.

© CEATEC Medizintechnik GmbH & Co. KG - 08/2010
*We reserve the right of technical modifications.
Printed in Germany.*

© CEATEC Medizintechnik GmbH & Co. KG - 08/2010
Con riserve di modifiche tecniche.
Stampato nella Repubblica Federale Tedesca.

© CEATEC Medizintechnik GmbH & Co. KG - 08/2010
*Reservado el derecho de efectuar modificaciones técnicas.
Impreso en Alemania.*

Tuttlingen, eine idyllische Kreisstadt (mit ca. 34.500 Einwohnern), gelegen zwischen dem Schwarzwald im Westen und dem Bodensee im Südosten.

Tuttlingen wurde im Jahre 797 n. Chr. zum ersten Mal urkundlich erwähnt.

Tuttlingen, is a small city with a population of 34.500, located between the Black Forest to the west and the Lake of Constance to the south-east.

Tuttlingen was officially first mentioned in 797 a.C.

Tuttlingen, una città idillica (capoluogo con ca. 34.500 abitanti) situata tra la Foresta Nera ad ovest ed il Lago di Costanza a sudest.

Tuttlingen, fu per la prima volta documentata nell'anno 797 d.C.

Tuttlingen, una ciudad idílica, capital de distrito (con aproximadamente 34.500 habitantes), situada entre la Selva Negra al oeste y el Lago de Constanza al sureste.

Tuttlingen fue citad por primera vez en documentos en el año 797 D.C.



Kurze Wegbeschreibung:

Von Süden kommend, erreichen Sie uns über Zürich - Autobahn (A 81) Richtung Stuttgart - Abfahrt Geisingen (B 311), oder von Westen, über Freiburg - Bundesstraße (B 31/B 311).

How to find us:

Coming from the South, you can reach us from Zurich - Motorway/Highway (A 81) - direction Stuttgart, Motorway/Highway exit Geisingen - direction Tuttlingen (B 311), Coming from the West, you can reach us from Freiburg direction Titisee-Neustadt (B 31), Geisingen (B 311), Tuttlingen/Wurmlingen.

Come raggiungerci:

Da sud attraversando Zürich - ed imboccando l'autostrada (A 81) in direzione Stuttgart - uscita Geisingen - (B 311), oppure attraverso Freiburg percorrendo la statale (B 31/B 311).

Descripción corta:

Llegando por el sur, usted nos encuentra a través de la autopista-Zürich - en dirección a Stuttgart (A 81) - salida Geisingen - (B 311), o viniendo del oeste por Freiburg - carretera federal (B 31/B 311).



Unsere Firmenphilosophie

Für alle verpflichtend:

Der Kunde steht im Mittelpunkt

- ★ Der Kunde ist die wichtigste Person für unser Unternehmen, egal ob er anwesend ist, ob er schreibt oder anruft.
- ★ Er ist nicht von uns abhängig, sondern wir von ihm.
- ★ Er stört uns nicht bei der Arbeit, sondern ist in Sinn und Zweck ihr Inhalt.
- ★ Er ist kein Fremder, sondern ein lebender Bestandteil unseres Geschäfts. Wenn wir seine Wünsche erfüllen, tun wir ihm keinen Gefallen. Er tut uns einen Gefallen, wenn er sich seine Wünsche durch uns erfüllen lässt.
- ★ Er ist keine Nummer, sondern ein Mensch aus Fleisch und Blut. Mit Eigenschaften und Stimmungen, wie auch wir sie haben.
- ★ Er kommt nicht zu uns, um Streitgespräche zu führen oder seine Intelligenz messen zu lassen. Aber er hat das Recht, seine Meinung zu äußern.
- ★ Er legt uns sein Wünsche vor. Unsere Aufgabe ist es, diese Wünsche sowohl für ihn als auch für uns gewinnbringend zu erfüllen.

Our Company Philosophy

Our obligations:

The customer is the our first priority

- ★ *The customer is the most important person for our company, whether he is present, writes or calls.*
- ★ *He is not dependent on us - we depend on him.*
- ★ *He does not interrupt our work, but is the reason and purpose of it.*
- ★ *He is not a stranger, but a living part of our business. If we comply with his requests, we are not doing him a favour. He is doing us a favour in letting us fulfill his wishes.*
- ★ *He is not just a number, but a person with characteristics and moods, just like us.*
- ★ *He doesn't come to us to argue or to partake in a combat of intelligence. However, he has the right to voice his opinion.*
- ★ *He presents his case and requirements. It is our job to fulfill his requirements profitably - for him and for us.*

Filosofia della nostra impresa

Vale per tutti:

Il cliente é al centro della nostra attenzione

- ★ Il cliente é la persona piú importante per la nostra azienda - che sia presente, che telefoni o che scriva.
- ★ Il cliente non dipende da noi, ma noi dal nostro cliente.
- ★ Il cliente non ci disturba durante il nostro lavoro, ma lui é l'obiettivo e la ragione per il nostro lavoro.
- ★ Il cliente non é un estraneo, ma un componente vivo dei nostri affari. Se noi soddisfacciamo i suoi desideri, non gli facciamo un favore. Lui fa un favore a noi, se ci permette di soddisfare le sue esigenze.
- ★ Il cliente non é un numero, ma un essere umano fatto di carne e sangue. Ha delle caratteristiche ed umori come l'abbiamo anche noi.
- ★ Il cliente non viene da noi per fare dibattiti o per misurare la sua intelligenza. Però lui ha il diritto di esprimere la sua opinione.
- ★ Il cliente ci sottopone le sue esigenze. È il nostro obbligo di soddisfare queste esigenze in modo fruttuoso per ambedue le parti.

Nuestra filosofía de empresa

Válido para todos:

El cliente: nuestro centro de atencion

- ★ *El cliente es la persona más importante para nuestra empresa, sea por teléfono, por correspondencia o personalmente.*
- ★ *Él no depende de nosotros, sino que somos nosotros los que dependemos de él.*
- ★ *No nos molesta en nuestro trabajo, sino que es el sentido y la finalidad de éste.*
- ★ *Él no es ningún extranjero, sino un componente vivo de nuestro negocio. Cuando cumplimos sus deseos no le estamos haciendo ningún favor. Él nos hace un favor cuando nos deja ser los que cumplamos sus deseos.*
- ★ *El cliente no es ningún número. Es una person de carne y hueso. Con cualidades y estados de ánimo, como nosotros también tenemos.*
- ★ *Él no se dirige a nosotros para mantener discusiones o medir su in teligencia. Pero, tiene todo el derecho a darnos su opinión.*
- ★ *Nuestro cliente nos muestra sus deseos. Nuestra tarea es cuplir éstos de forma provechosa tanto para él como para nosotros.*



CEATEC ist ein kleines Familienunternehmen (gegründet 1995) mit Sitz in Wurmlingen bei Tuttlingen. CEATEC hat sich auf den Vertrieb von hochwertigen Instrumenten "Made in Germany" spezialisiert. Der Gründer und seine Mitarbeiter können auf eine 30jährige Erfahrung in der Medizintechnik im internationalen Wettbewerb zurückblicken. Unsere Prämissen sind:

- QUALITÄT - SICHERHEIT - VERTRAUEN - SERVICE -

Durch unsere hohen Qualitätsansprüche garantieren wir eine Langlebigkeit und ein im Preis - Leistungsverhältnis kostengünstiges Produkt. In den Mittelpunkt unserer Tätigkeit setzen wir die Forderungen und Notwendigkeiten unserer Kunden.

CEATEC is a small family company (founded in 1995) located in Wurmlingen close to Tuttlingen. CEATEC is specialized in the distribution of high quality surgical instruments "Made in Germany". The company's founder, and also the members of staff, can look back on more than 30 years of experience in the international market. Our objectives are:

- QUALITY - PRODUCT SAFETY - DEPENDABILITY - SERVICE -

In consideration of our high quality expectations, we are in a position to guarantee, constitutes a longlife, quality product at a low price. Our activities revolve around our customers demands and requirements.

CEATEC è una piccola impresa familiare (fondata nel 1995) con sede a Wurmlingen, vicino a Tuttlingen la quale si è specializzata nella vendita di strumenti ad alto livello "Made in Germany". Il suo fondatore ed i suoi collaboratori vantano una trentennale esperienza nel campo tecnico medicale a livello internazionale. I nostri obiettivi sono:

- QUALITÀ - SICUREZZA - FIDUCIA - SERVIZIO -

Grazie all'alto livello qualitativo dei nostri prodotti ne assicuriamo una lunga durata nel tempo e di conseguenza ne garantiamo la convenienza in un ottimale rapporto qualità prezzo. Nel centro delle nostre attività mettiamo le richieste e le necessità dei nostri clienti.

CEATEC es una pequeña empresa familiar (fundada en el año 1995) con sede en Wurmlingen al lado de Tuttlingen. Se ha especializado en la distribución de instrumental quirúrgico de alta calidad "Made in Germany". El fundador y sus colaboradores tienen una experiencia de más de treinta años en el sector de equipos médicos a nivel internacional. Nuestros objetivos son:

- CALIDAD - SEGURIDAD - SERVICIO - CONFIANZA -

Gracias al alto nivel de calidad de nuestros productos, les aseguramos una larga duración de vida y por consecuencia les garantizamos la ventaja de una óptima relación entre calidad y precio de nuestros productos. En el centro de nuestras actividades ponemos las exigencias y las necesidades de nuestros clientes.



Es gibt kaum etwas auf dieser Welt, das nicht irgend jemand ein wenig schlechter machen und etwas billiger verkaufen könnte, und die Menschen, die sich nur am Preis orientieren, werden die gerechte Beute solcher Machenschaften. Es ist unklug, zu viel zu bezahlen, aber es ist noch schlechter, zu wenig zu bezahlen. Wenn Sie zu viel bezahlen, verlieren Sie etwas Geld, das ist alles. Wenn Sie dagegen zu wenig bezahlen, verlieren Sie manchmal alles, da der gekaufte Gegenstand die ihm zugedachte Aufgabe nicht erfüllen kann. Das Gesetz der Wirtschaft verbietet es, für wenig Geld viel Wert zu erhalten. Nehmen Sie das niedrigste Angebot an, müssen Sie für das Risiko, das Sie eingehen, etwas hinzurechnen. Und wenn Sie das tun, dann haben Sie auch genug Geld, um für etwas Besseres zu bezahlen.

John Ruskin
engl. Sozialreformer (1819-1900)

*There is nothing in this World, that someone cannot make in a lesser form to enable it to be sold for less, and thus, people who orientate themselves solely by price, are worthy victims of this phenomenon.
It is unwise, to pay too much, but it is even worse to pay too little. If you pay too much, you loose a little money, that is all. If you pay too little, you sometimes loose everything, as the purchased item does not fulfill the purpose it was originally purchased for.
The law of economics forbids us to obtain high value for a low price. If you accept the lowest offer, you have to accept the risk that you may have to pay more. Should you accept this risk, then you certainly have enough money to purchase something better to begin with.*

John Ruskin
engl. social reformer (1819-1900)

Non esiste cosa a questo mondo che non possa essere offerta in qualità inferiore e che possa essere venduta ad un prezzo più conveniente. Le persone, che si orientano solo secondo il prezzo, diventano la giusta preda di queste macchinazioni. Non è intelligente, pagare troppo, ma è ancora peggio pagare troppo poco. Quando pagate troppo, perdetevi un po' di denaro, questo è tutto. Quando al contrario pagate troppo poco perdetevi talvolta tutto, perchè l'oggetto comprato non soddisfa i fini per cui era stato concepito. Le leggi dell'economia proibiscono di ottenere molto valore in cambio di poco denaro. Quando scegliete l'offerta più bassa, dovete calcolare sempre qualcosa in più per il rischio a cui andate incontro. E, se fate questo, allora avete abbastanza denaro per pagare qualcosa di miglior qualità.

John Ruskin
Riformatore Sociale ingl. (1819-1900)

*Non existe apenas ninguna cosa en este mundo que no se pueda ofrecer en calidad inferior y que no se pueda vender a un precio más conveniente. Las personas que sólomente se orientan por el precio, serán la justa presa de estas maquinaciones.
No es inteligente pagar demasiado, pero es aún peor pagar demasiado poco. Cuando pagáis demasiado, perdéis un poco de dinero, esto es todo. Cuando al contrario pagáis demasiado poco, perdéis a veces todo, porque el objeto comprado no puede satisfacer el fin para el cual era destinado.
La ley de la economía prohíbe obtener mucho valor al cambio de poco dinero. Si aceptáis la oferta más baja, siempre teneis que calcular un poco más alto para cubrir el riesgo que enfrentáis.
Y si actuáis de esta manera, entoces tenéis bastante dinero para pagar una cosa de mejor calidas.*

John Ruskin
Reformador social ingl. (1819-1900)

Instrumenten - Werdegang
Stages of an Instrument
Elaborazione di uno strumento chirurgico
Elaboración de un instrumento quirúrgico



Werdegang eines Instrumentes (z.B. Arterienklemme)

Stages of an instrument (using a haemostatic forceps as an example)

Fasi di produzione di uno strumento (p.e. Pinza Emostatica)

El proceso de elaboración de un instrumento (p.e. Pinza Hemostática)

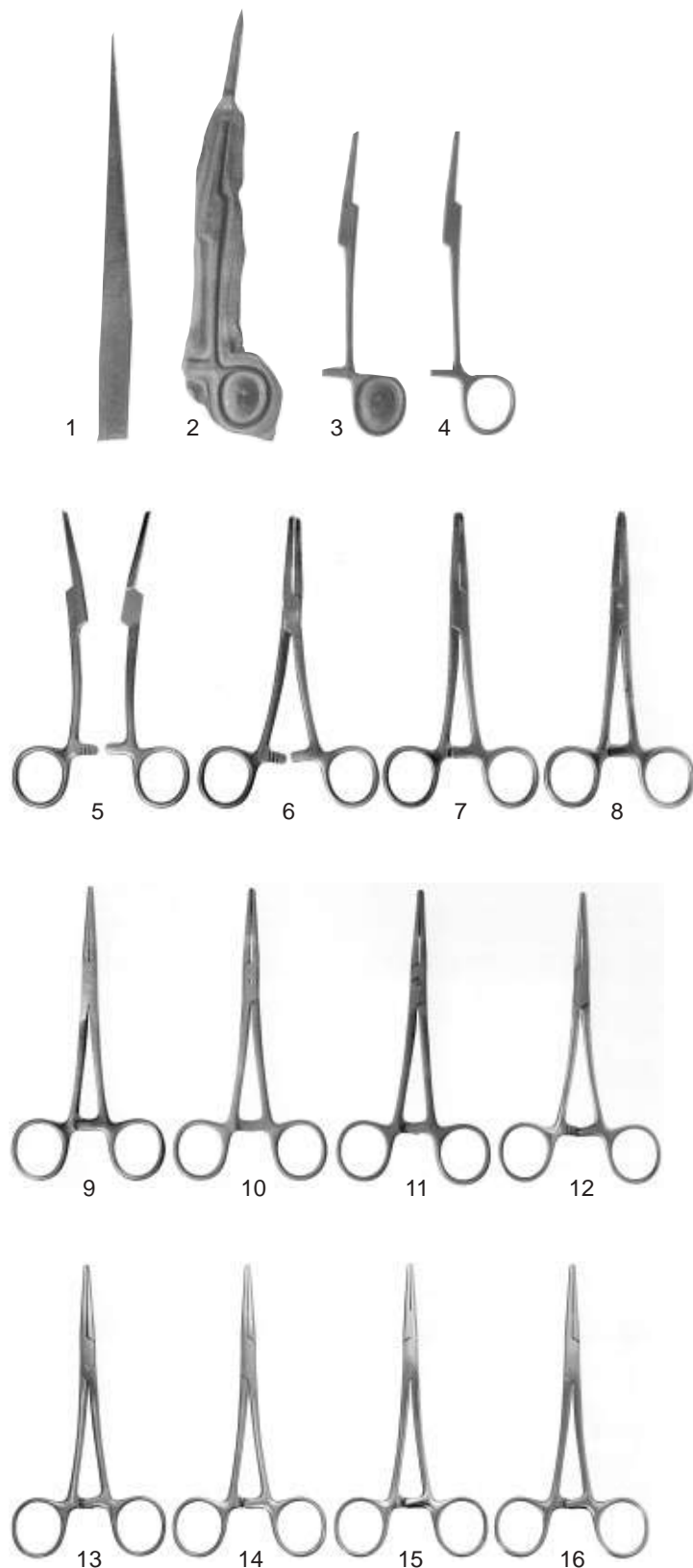

1. Spalten von flachen Stahlstangen.
Splitting of a flat steel rod.
Spaccare le barre di ferro.
El partir barras de acero planas.
2. Abgraten: Instrument wird ausgestochen.
Removal of flash: Instrument is stamped out.
Lo strumento: Materia prima.
Instrumento: Materias primas.
3. Rohling.
Raw instrument.
Lo strumento grezzo - senza bordi.
La pieza de partida.
4. Fräsen: Sperre, Schluß, Maul.
Milling: ratchet, box lock, jaw area.
Fresature: cremagliera, incastro, morso.
El fresado: cremallera, engaste, boca.
5. Zusammenfügen der beiden Instrumententeile.
Both parts fitted together.
Collegamento delle due parti dello strumento.
El ensamblar las dos partes del instrumento.
6. Verschiedene Handarbeiten.
Instrument adjusted by hand.
Vari lavorazioni a mano.
Diversos procesos manuales.
7. Feilen.
Filing.
Limare.
Limar.
8. Schleifen.
Grinding.
Affilare.
Affilar.
9. Schluß vorbohren für Stift oder Schraube.
Joint drilled for screw or rivet.
Forare l'incastro per un perno o vite.
Perforación previa para espiga o tornillo.
10. Härten.
Hardening.
Tempra.
Templar.
11. Polieren.
Polishing.
Prima brunitura.
Pulir.
12. Mattieren (bürsten oder sandstrahlen).
Satin finish (brushed or sand blasted).
Opacizzare (spazzolare o sabbiare).
Matear (cepillar o arenar).
13. Elektropolieren.
Electro polishing.
Brunitura ad ultrasuono.
Pulimentación electrolítica.
14. Auswaschen.
Washing.
Pulire.
Lavar.
15. Ölen.
Oiling.
Lubrificare.
Aceitar.
16. Fertiges Instrument.
Finished instrument.
Strumento finito.
Instrumento terminado.

Fachbegriffe einer Arterienklemme
Technical description for artery forceps
Descrizione tecnica di una pinza emostatica
Descripción técnica de una pinza hemostática

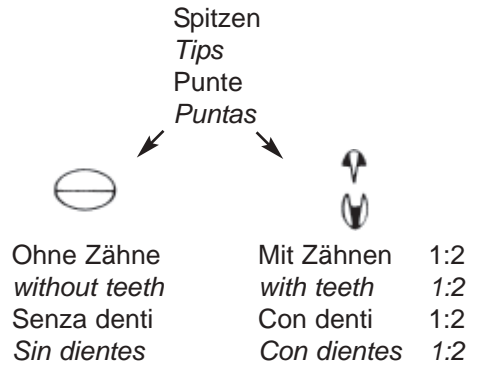
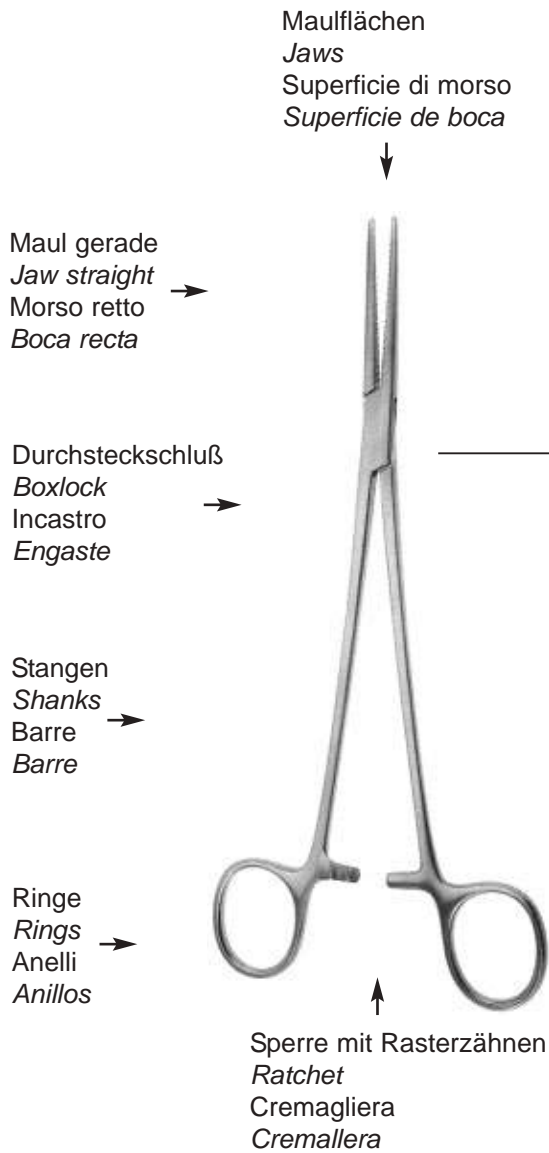

Branchen
Branchs
 Branche
 Ramos

Maulbiegung
Jaw curvature
 Curvature del morso
 Curvaturas de boca

Riefungen
Serrations
 Zigrinature
 Ranuras

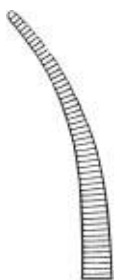

Gerade
Straight
 Retto
 Recta

Gebogen
Curved
 Curvo
 Curva



Quer
Horizontal
 Orizontale
 Horizontale



Längs
Longitudinal
 Longitudinale
 Longitudinal



Kreuz
Cross
 Croce
 Cruz

Fabrikneue chirurgische Instrumente sind vor der ersten Sterilisation zu reinigen.

Arterienklemmen müssen im geöffnetem Zustand gereinigt werden.

Vor dem Sterilisieren, d.h. beim Zusammenstellen der Operationssiebe sollte die die Rastensperre nur im ersten Zahn geschlossen werden, dadurch wird vermieden, daß die Instrumente während der Sterilisation (Temperaturerhöhung auf 134°C) unter Spannung stehen und Spannungsrisse im Schluß auftreten.

Das Zureichen während der OP wird erleichtert.

Sterilisation ist kein Ersatz für Sauberkeit!

Brand new surgical instruments should be cleaned before they are sterilized.

Haemostatic forceps should be open at the jaw end when they are cleaned.

Before the instruments are put into the sterilization tray, the ratchet should be fixed into the first notch. This is done to prevent tension or even tension cracks in the joint area during sterilization (temperatures of up to 134°C).

Serving the instruments during the operation is made easier.

Sterilization does not replacement cleanliness!

Nuovi strumenti chirurgici, primo della prima sterilizzazione debbono essere lavati.

Le pinze emostatiche debbono essere pulite in posizione aperta.

Prima della sterilizzazione, quindi durante la composizione dei set operativi, la cremagliera delle pinze emostatiche dovrebbe essere chiusa solo nel primo scatto. Così, si evita che gli strumenti siano sotto pressione durante la sterilizzazione (aumento di temperatura fino a 134°C) e ciò potrebbe infatti causare delle screpolature di tensione sull'incastro dello strumento.

Durante l'intervento, il passaggio degli strumenti al chirurgo é piu facile.

La sterilizzazione non sostituisce la pulizia!

Los instrumentos quirúrgicos nuevos deben ser limpiados antes de la primera esterilización.

Las pinzas hemostáticas deben ser limpiadas estando abiertas.

Antes de la esterilización, es decir al colocar juntos los tamices de operación, se debe colocar la muesca de retención en el primer diente, para evitar que durante la esterilización los instrumentos (elevación de la temperatura a 134°C) estén bajo tensión y se presenten rajaduras.

El pasar los instrumentos durante la operación es facilitado.

La esterilización no es sustituto de la limpieza!

**Resultate unsachgemäßer Behandlungen - Results for improper preparation -
Risultati di trattamenti non conformi - Resultados del tratamiento inadecuado**



Internal korrodierender Spannungsriß
Internal corroding tension crack
Incrinatura da tensioni interne corrosa
Corrosión en grietas internas por tensión



Perforierende Korrosion verursacht durch Chloride
Perforating corrosion due to chloride
Corrosione perforante causata da cloruri
Corrosión perforante causada por cloruro

CT - ORO Hartmetalleinsätze
 CT - ORO Tungsten Carbide Inserts
 CT - ORO Inserti al carburo di tungsteno
 CT - ORO Filos de carburo de tungsteno



Das Profil ist abhängig vom Einsatz
 The profile depends on the use
 Il profilo dipende dall'uso
 El perfil depende al uso

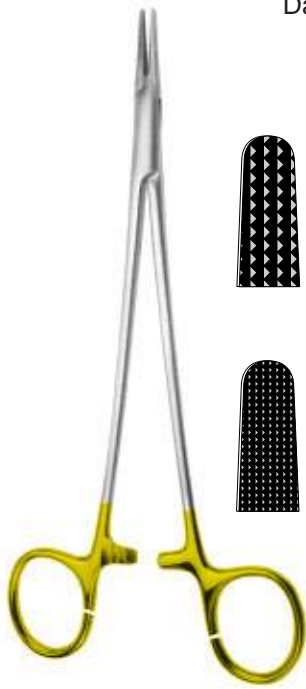

Normalprofil
 Normal profile
 Profilo normale
 Profil normal
 0,5 mm



Miniprofil
 Mini profile
 Profilo mini
 Profil mini
 0,4 mm



Microprofil
 Micro profile
 Profilo micro
 Profil micro
 0,3 mm



Glatt
 Smooth
 Liscio
 Plano

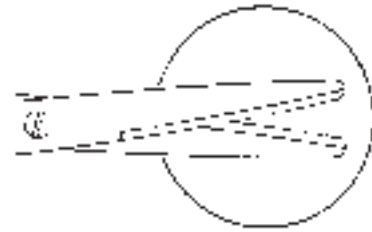
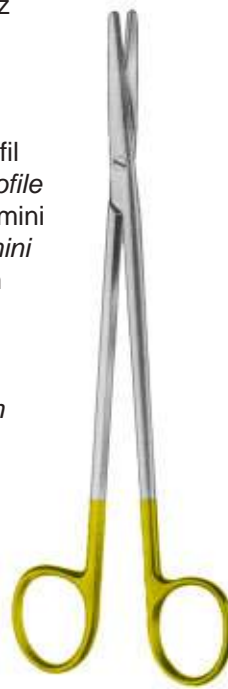

- Hervorragende Schnitthaltigkeit
- Gezielter scharfer Schnitt
- Solid weicher Gang
- Remarkable cutting power retention
- Concise, sharp cut
- Solid, soft movement
- Eccelente accuratezza del taglio
- Taglio ottimale per anni
- Taglio delicato
- Corte de máxima agudeza
- Corte óptimo para años
- Accionamiénto suave, corte exacto

- Hohe Wirtschaftlichkeit
- Lange Lebensdauer
- Vergoldete Ringe zur schnellen Identifikation

- High economy
- Long life duration
- Gold rings for rapid identification

- Risparmi sul costo
- Prestazioni di lunga durata
- Anelli d'orati per una semplice identificazione

- Gran economía
- Duración
- Mangos dorados para su identificación

Atraumatic - Zahnung
 Atraumatic - Toothing
 Atraumatic - Dentature
 Atraumatic - Dentaturas



DE BAKEY

- 1:2 Zahnreihen
- 1:2 Rows of teeth
- 1:2 Dentalatura
- 1:2 Dentatura

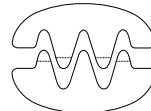

DE BAKEY

- 2:3 Zahnreihen
- 2:3 Rows of teeth
- 2:3 Dentalatura
- 2:3 Dentatura

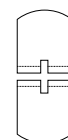

COOLEY

- 2:2 Zahnreihen
- 2:2 Rows of teeth
- 2:2 Dentalatura
- 2:2 Dentatura

DE BAKEY-SATINSKY

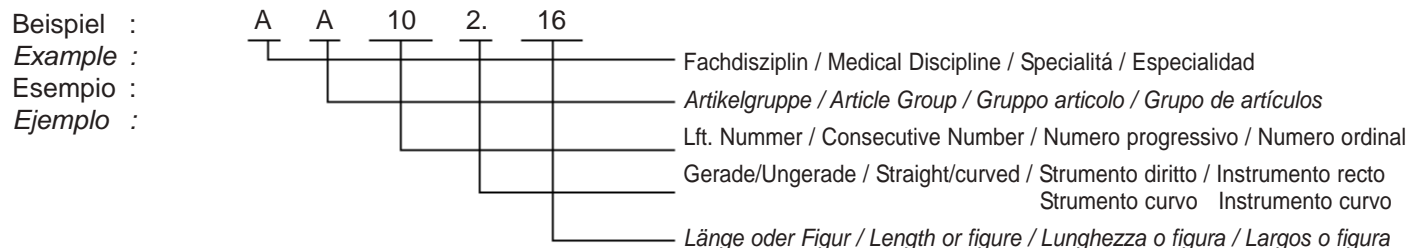

Fachdisziplinen

- A = Allgemeines Instrumentarium
- C = Cardio Vasculär
- D = Dental
- E = Elektromedizin
- G = Gynäkologie/Geburtshilfe
- H = High Quality
- I = Handchirurgie
- K = Knochenchirurgie
- L = Laryngologie
- M = Mikrochirurgie
- N = Neurochirurgie
- O = Otologie
- P = Proktologie Magen/Darm
- R = Rhinologie
- S = Sterilisation
- T = Minimal Invasive Chirurgie
- U = Urologie
- W = Sonderbeschaffung
- Y = Reparaturen
- Z = Zubehör

Discipline

- A = General Instruments
- C = Cardio Vascular
- D = Dental
- E = Electro-Medicine
- G = Gynecology/Obstetrics
- H = High Quality
- I = Hand Surgery
- K = Bone Surgery
- L = Laryngology
- M = Micro-Surgery
- N = Neurosurgery
- O = Otolaryngology
- P = Proctology
Stomach/Intestines
- R = Rhinology
- S = Sterilization
- T = Minimal Invasive Surgery
- U = Urology
- W = Special orders
- Y = Repairs
- Z = Accessories

Disciplina

- A = Strumentario generale
- C = Cardiovascolare
- D = Dentale
- E = Elettromedicina
- G = Ginecologia/Parto
- H = Alta-Qualità
- I = Chirurgia della mano
- K = Ortopedia
- L = Laringologia
- M = Microchirurgia
- N = Neurochirurgia
- O = Otologia
- P = Proctologia stomaco/intestino
- R = Rinologia
- S = Sterilizzazione
- T = Chirurgia mininvasiva
- U = Urologia
- W = Articoli fuori programma standard
- Y = Riparazioni
- Z = Accessorio

Especialidad

- A = Instrumental General
- C = Cardiovascular
- D = Dental
- E = Electromedicina
- G = Ginecología
- H = Alta-Calidad
- I = Cirugía de la mano
- K = Cirugía ósea
- L = Laringología
- M = Microcirugía
- N = Neurocirugía
- O = Otolología
- P = Proctología
- R = Rinología
- S = Esterilización
- T = Cirugía mínimamente invasiva
- U = Urología
- W = Encargos especiales
- Y = Reparaciones
- Z = Complementos

Artikelgruppen

- A = Scheren/Scalpelle
- B = Pinzetten
- C = Klemmen
- D = Wundhaken
- E = Naht/Nadelhalter
- F = Gewebefäßzangen
- H = Hohlmeißelzangen
- J = Zahnzangen
- K = Küretten
- L = Laminektomie-Stanzen (Rongeurs)
- M = Meißel
- O = Bohrer
- P = Platten
- R = 18/10 Produkte
- S = Schrauben
- T = Tupferzangen
- U = Spektula
- V = Verschiedenes
- W = Wurzelheber
- Y = Saugrohre
- Z = Elektromedizinisches Zubehör

Article Group

- A = Scissors/scalpels
- B = Forceps
- C = Clamps/Forceps
- D = Retractors
- E = Needleholders
- F = Tissue Forceps
- H = Bone Rongeur Forceps
- J = Dental Forceps
- K = Curettes
- L = Laminectomy punches (Rongeurs)
- M = Chisels
- O = Drills
- P = Plates
- R = 18/10 products
- S = Screws
- T = Sponge/Dressing Forceps
- U = Specula
- V = Various
- W = Root elevators
- Y = suction pipes
- Z = Electro-medical accessories

Tipologia dello strumento

- A = forbici/lame
- B = pinze (chirurgiche/anatomiche)
- C = pinze (emostatiche ed altri)
- D = divaricatori
- E = suture/portaghi
- F = pinze per tessuti
- H = pinze sgorbie
- J = tenaglie
- K = curette
- L = pinze per laminectomia
- M = scalpelli
- O = frese
- P = placche
- R = prodotti in acciaio inoss.18/10
- S = viti
- T = pinze per tamponi
- U = specula
- V = varie
- W = leve
- Y = aspiratori
- Z = accessorio elettromedicale

Grupo de artículos

- A = Tijeras/Bisturías
- B = Pinzas de disección
- C = Pinzas-clamps para hemostasia
- D = Separadores
- E = Material de sutura/Porta-agujas
- F = Pinzas para coger tejidos
- H = Pinzas-gubias
- J = Fórceps dentales / Pinzas dentales
- K = Cucharillas
- L = Pinzas cortantes para Laminectomía
- M = Cinceles
- O = Taladros / Perforadores
- P = Placas
- R = Contenedores y Accesorios en aleación 18/10
- S = Tornillos
- T = Pinzas para tampones
- U = Espéculos
- V = Varios
- W = Elevadores
- Y = Tubos de aspiración
- Z = Accesorios para Electromedicina

- Ausgesuchte Rohmaterialien
- Akkurate Oberflächenbehandlung
- Finish ist matt / hochglanz poliert
- Mehrfache Qualitäts- und Funktionskontrollen



zeichnen ein Instrument aus dem Programm der „High-Qualität“ aus.

- *Selectet raw material*
- *Good finish*
- *Finishing and burnishing*
- *Final inspection of functional and finish qualities*



distingui one instruments from the range „High-Quality“.

- *Prima scelta della materia prima*
- *Accurata rifinitura della superficie*
- *La rifinitura é oppaca / levigata luccida*
- *Molteplice controlli di qualità e funzionalità*



distingue uno strumento della linea di „Alta-Qualität“.

- *Materias primas seleccionadas*
- *Esmerado tratamiento de la superficie*
- *El terminado es mate / pulido al brillo*
- *Repetidos controles de calidad y funcionamiento*



distingue un instrumento de la línea de „Alta-Calidad“.

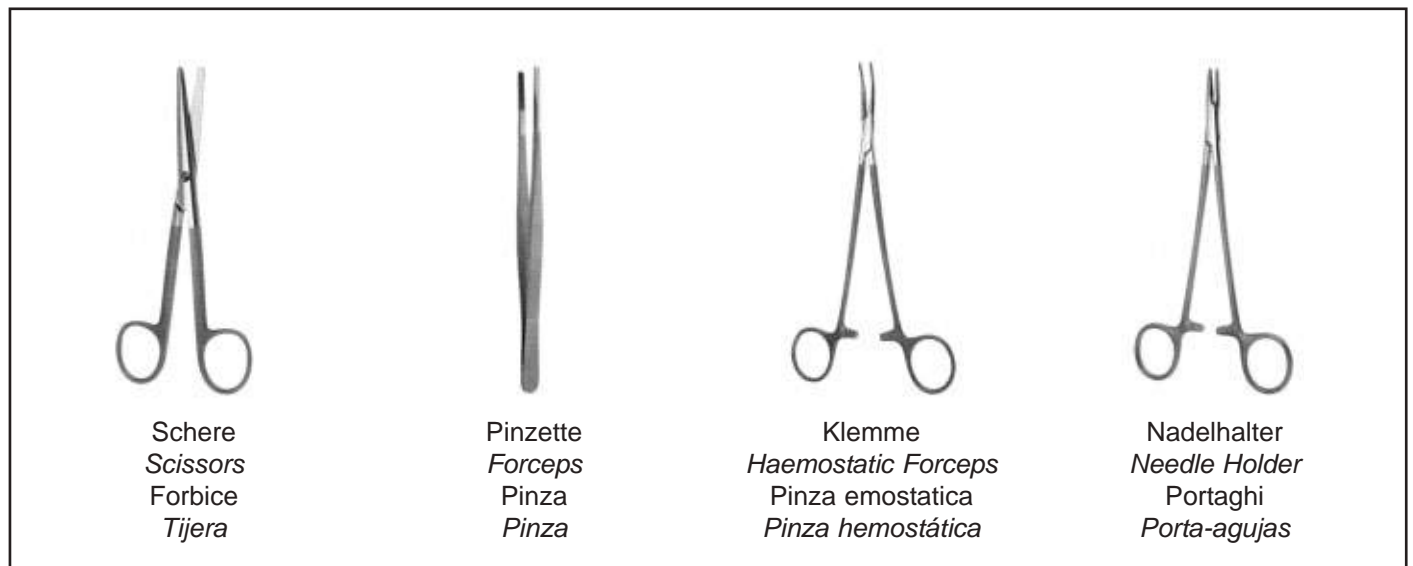

Schere / Scissors / Forbice / Tijera

Mayo-Stille	Metzenbaum	Metzenbaum-Nelson
HA 180.15	HA 250.14	HA 280.18
HA 180.17	HA 255.14	HA 280.20
HA 181.15		HA 280.23
HA 181.17		HA 285.18
		HA 285.20
		HA 285.23

Pinzetten / Forceps / Pinze / Pinzas

Metzenbaum	Stille
HB 192.18	HB 130.15
HB 192.21	HB 130.18
HB 192.25	
HB 392.18	
HB 392.21	
HB 392.25	

Klemmen / Haemostatic Forceps / Pinze emostatic / Pinzas hemostáticas

Adson	Halsted-Mosquito	Heiss
HC 421.14	HC 316.18	HC 422.20
HC 421.18	HC 316.21	HC 423.20
	HC 317.18	HC 425.20
Mixter	HC 317.21	
HC 419.18		

Klemmen / Haemostatic Forceps / Pinze emostatic / Pinzas hemostáticas

Crile-Murray	Hegar-Baumgartner	Mayo-Hegar
HE 348.15	HE 340.14	HE 396.16
		HE 396.18
		HE 396.20
Crile- Wood		
HE 350.15		

SKALPELLE, SKALPELLGRIFFE, SCHEREN <i>KNIVES, SCALPEL HANDLES, SCISSORS</i> BISTURI, MANICI PER BISTURI, FORBICI <i>BISTURIES, MANGOS DE BISTURIES, TIJERAS</i>	Seite 1 - 88 Page 1 - 88 Pagina 1 - 88 Páginas 1 - 88
--	--



PINZETTEN <i>FORCEPS</i> PINZE <i>PINZAS</i>	Seite 89 - 112 Page 89 - 112 Pagina 89 - 112 Páginas 89 - 112
---	--



ARTERIENKLEMMEN, TUPFER-, KORNZANGEN <i>ARTERY FORCEPS, SWAB-, DRESSING FORCEPS</i> PINZE EMOSTATICHE, PINZE PER TAMPONI <i>PINZAS HEMOSTÁTICAS , PINZAS PARA TAMPONES</i>	Seite 113 - 153 Page 113 - 153 Pagina 113 - 152 Páginas 113 - 152
---	--

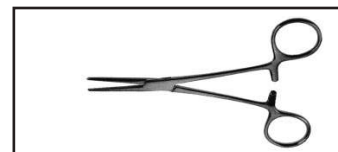

WUNDHAKEN, BAUCHDECKENHALTER <i>RETRACTORS, ABDOMINAL RETRACTORS</i> DIVARICATORI, DIVARICATORI ADDOMINALI <i>SEPARADORES, SEPARADORES ABDOMINALES</i>	Seite 153 - 216 Page 153 - 216 Pagina 153 - 216 Páginas 153 - 216
---	--



NADELHALTER, NAHTINSTRUMENTE <i>NEEDLE HOLDERS, SUTURE INSTRUMENTS</i> PORTAGHI, STRUMENTI PER SUTURA <i>PORTA-AGUJAS, STRUMENTAL PARA SUTURAS</i>	Seite 217 - 252 Page 217 - 252 Pagina 217 - 252 Páginas 217 - 252
---	--

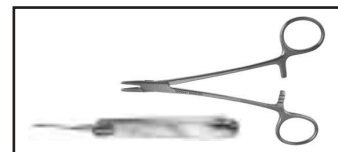

CT - ORO NADELHALTER <i>CT - ORO NEEDLE HOLDERS</i> CT - ORO PORTAGHI <i>CT - ORO PORTA-AGUJAS</i>	Seite 229 - 240 Page 229 - 240 Pagina 229 - 240 Páginas 229 - 240
---	--



GEWEBE- UND ORGANFASSZANGEN <i>TISSUE AND ORGAN HOLDING FORCEPS</i> PINZE PER AFFERRARE TESSUTI ED ORGANI <i>PINZAS PARA TEJIDOS Y ÓRGANOS</i>	Seite 253 - 260 Page 253 - 260 Pagina 253 - 260 Páginas 253 - 260
---	--

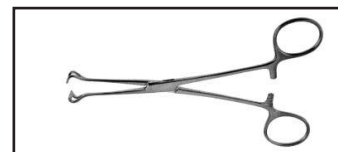

SONDEN <i>POBES</i> SONDE <i>ESTILETES</i>	Seite 261 - 264 Page 261 - 264 Pagina 261 - 264 Páginas 261 - 264
---	--

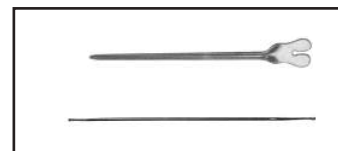



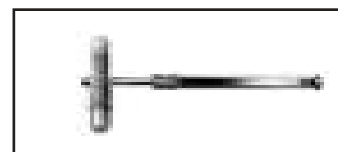



DIAGNOSTIK, MESSINSTRUMENTE <i>DIAGNOSTICS, MEASURING INSTRUMENTS</i> DIAGNOSTICA, STRUMENTI PER MISURARE <i>DIAGNÓSTICO, INSTRUMENTAL PARA MEDIR</i>	Seite 265 - 272 Page 265 - 272 Pagina 265 - 272 Páginas 265 - 272
--	--

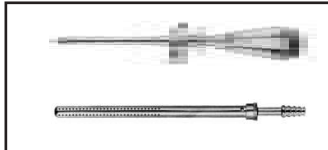

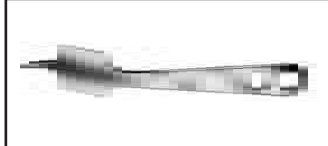
Für Notizen
For notes
Per notizie
Para notas

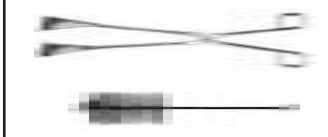

<p>NARKOSE ANAESTHESIA ANESTESIA ANESTESIA</p>	<p>Seite 273 - 280 Page 273 - 280 Pagina 273 - 280 Páginas 273 - 280</p>	
<p>TROKARE, SAUGROHRE TROCARS, SUCTION TUBES TREQUARTI, TUBI D'ASPIRAZIONE TRÓCARES, TUBOS DE ASPIRACIÓN</p>	<p>Seite 281 - 288 Page 281 - 288 Pagina 281 - 288 Páginas 281 - 288</p>	
<p>CARDIOVASCULAR CARDIOVASCULAR SURGERY CHIRURGIA CARDIOVASCOLARE CIRUGÍA CARDIOVASCULAR</p>	<p>Seite 289 - 338 Page 289 - 338 Pagina 289 - 338 Páginas 289 - 338</p>	
<p>GYNÄKOLOGIE, GEBURTSHILFE GYNECOLOGY, OBSTETRICS GINECOLOGIA, OSTETRICIA GINECOLOGIA, OBSTETRICIA</p>	<p>Seite 339 - 370 Page 339 - 370 Pagina 339 - 370 Páginas 339 - 370</p>	
<p>KNOCHENCHIRURGIE BONE SURGERY CHIRURGIA OSSEA CIRUGÍA ÓSSEA</p>	<p>Seite 371 - 442 Page 371 - 442 Pagina 371 - 442 Páginas 371 - 442</p>	
<p>DARM, MAGEN, MASTDARM INTESTINES, STOMACH, RECTUM INTESTINO, STOMACO, RETTO INTESTINOS, ESTÓMAGO, RECTO</p>	<p>Seite 443 - 460 Page 443 - 460 Pagina 443 - 460 Páginas 443 - 460</p>	
<p>GALLE, LEBER, NIERE, BLASE, UROLOGIE GALL, LIVER, KIDNEY, BLADDER, UROLOGY BILE, FEGATO, RENE, VESCICA, UROLOGIA BILIS, HÍGADO, RIÑÓN, VEJIGA, UROLOGÍA</p>	<p>Seite 461 - 474 Page 461 - 474 Pagina 461 - 474 Páginas 461 - 474</p>	
<p>STERILISATION STERILIZATION STERILIZZAZIONE ESTERILIZACIÓN</p>	<p>Seite 475 - 490 Page 475 - 490 Pagina 475 - 490 Páginas 475 - 490</p>	
<p>VERSCHIEDENE ARTIKEL VARIOUS ARTICLES ARTICOLI VARI ARTÍCULOS DIVERSOS</p>	<p>Seite 491 - 498 Page 491 - 498 Pagina 491 - 498 Páginas 491 - 498</p>	

Für Notizen
For notes
Per notizie
Para notas





SKALPELLE, SKALPELLGRIFFE
KNIVES, SCALPEL HANDLES
BISTURI, MANICI PER BISTURI
BISTURIÈS, MANGOS DE BISTURIÈS



AA 002.01 - AA 004.09



AA 002.01
Fig.1



AA 002.02
Fig.2



AA 002.03
Fig.3



AA 002.04
Fig.4



AA 002.05
Fig.5



AA 004.01
Fig.1



AA 004.02
Fig.2



AA 004.03
Fig.3



AA 004.04
Fig.4



AA 004.05
Fig.5



AA 004.06
Fig.6



AA 004.07
Fig.7



AA 004.08
Fig.8



AA 004.09
Fig.9



AA 023.10
255mm / 10"



VIRCHOW
AA 033.08



WALB
AA 036.11 - AA 036.17

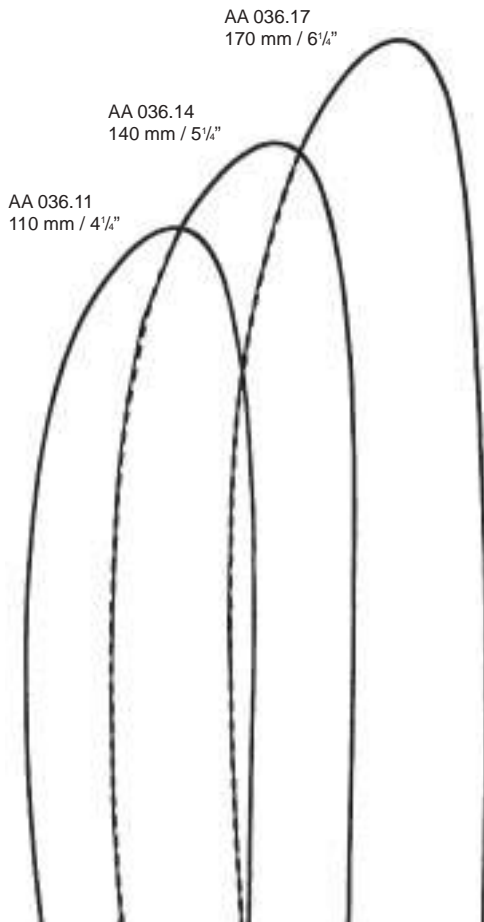

VIRCHOW
AA 038.16 - AA 038.24

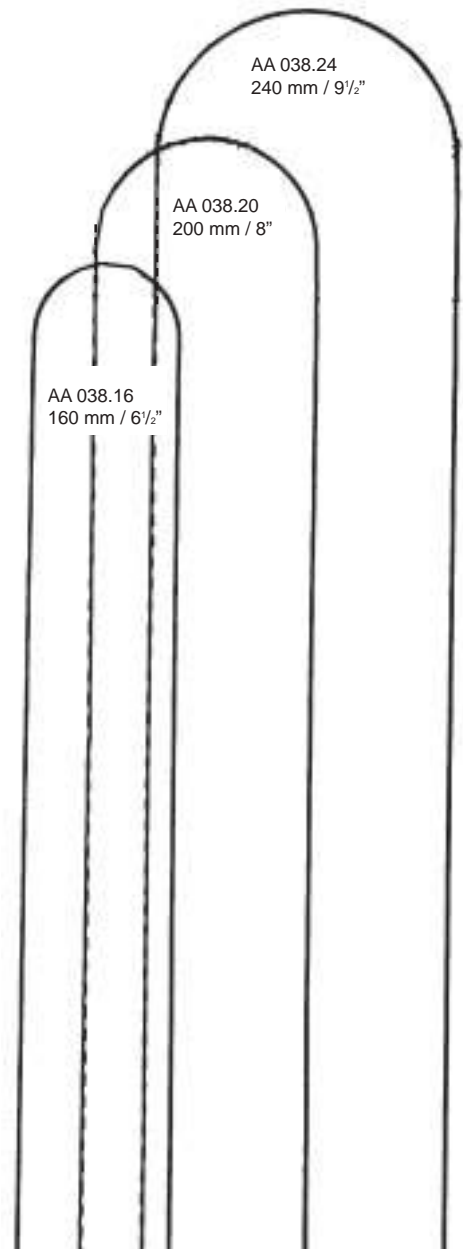



AA 050.19
290mm / 11½"



AA 057.01
180mm / 7"



AA 057.02
180mm / 7"

Schnittlänge:
Cutting length:
Lunghezza della lama
Largos de hojas:

190mm / 7½"

55mm / 2"

190mm / 7"

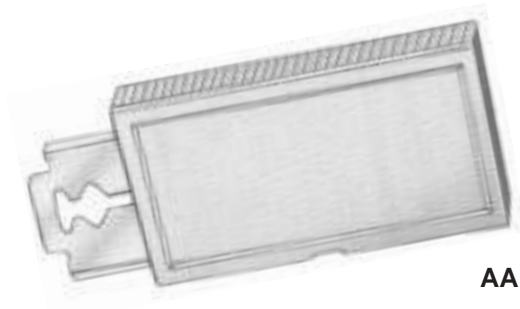

Packung á 10 Klingen
Package of 10 blades
Scatola con 10 lame
Paquete de 10 hojas

AA 096.00



TROUTMAN-CRIS
AA 090.09
100mm / 4"



CASTROVIEJO
AA 094.13
130mm / 5¼"

Skalpelligriffe
Scalpel Handles
Manici per bisturi
Mangos de bisturías



Für Skalpelligklingen: Fig. 18 bis Fig.36
 For Scalpel Blades: Fig. 18 to Fig.36
 Per Lame da bisturi : Fig. 18 fino Fig. 36
 Para Hojas de bisturías: Fig. 18 fino Fig.36



STANDARD
AA 100.04
No. 4

massiv
 solide
 pieno
 pleno



AA 104.34

massiv
 solide
 pieno
 pleno



AA 104.41
No. 4L

massiv
 solide
 pieno
 pleno



AA 104.45
No. 4L

massiv
 solide
 pieno
 pleno
 abgewinkelt
 angled
 angolare
 angulado



COLLIN
AA 108.08
No. 8

hohl, hollow, vuoto, hueco



COLLIN
AA 109.09
No. 9

hohl, hollow, vuoto, hueco

Skalpelligriffe
Scalpel Handles
Manici per bisturi
Mangos de bisturías



Für Skalpellklingen: Fig. 10 bis Fig. 17
 For Scalpel Blades: Fig. 18 to Fig. 17
 Per Lame da bisturi : Fig. 10 fino Fig. 17
 Para Hojas de bisturías: Fig. 10 fino Fig. 17



No. 3



STANDARD
AA 130.03
No. 3

massiv
 solid
 pieno
 pleno



AA 130.04
No. 3

massiv
 solid
 pieno
 pleno



AA 130.05
No. 3

massiv
 solid
 pieno
 pleno



AA 133.31
No. 3L

massiv
 solid
 pieno
 pleno



AA 133.35
No. 3L

massiv
 solid
 pieno
 pleno
 abgewinkelt
 angled
 angolato
 angolado

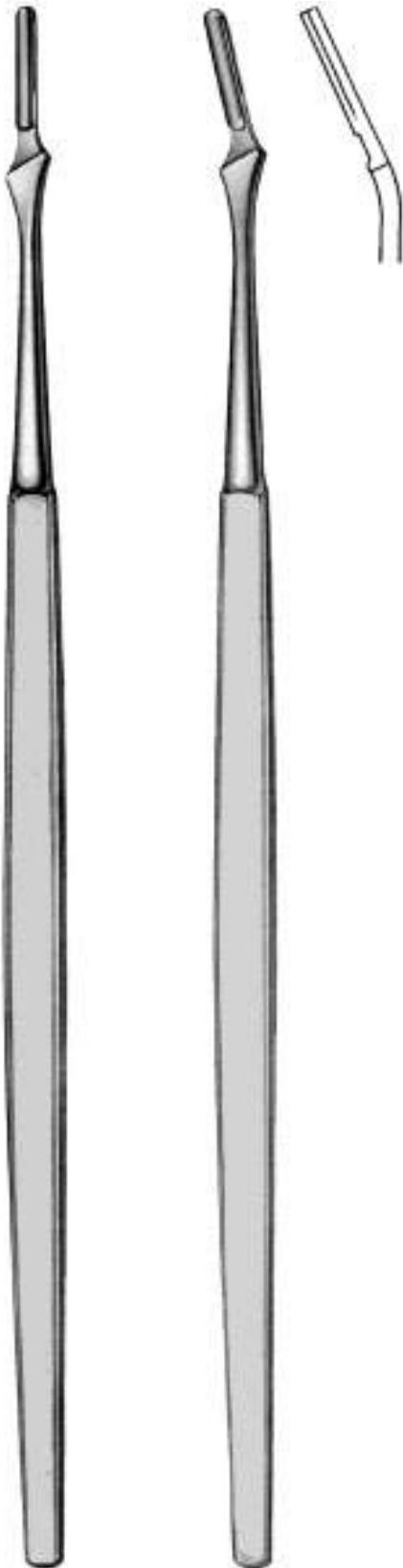

AA 134.24

AA 135.24



AA 137.07
 No. 7

massiv
 solid
 pieno
 pleno



AA 137.71
 No. 7K

massiv
 solid
 pieno
 pleno



AA 140.03

hohl rund
 hollow round
 vuoto rotondo
 hueco redondo



Fig.10

AA 155.10



Fig.11

AA 155.11



Fig.12

AA 155.12



Fig.12d

AA 156.12



Fig.13

AA 155.13

Verpackungseinheit: 100 Stück
Box: 100 pieces
Confezione: 100 pezzi
Confección: 100 piezas

* Doppelschneidig
* Double cutting edge
* Taglio doppio
* Dos filos de corte



Fig.14

AA 155.14



Fig.15

AA 155.15



Fig.15c

AA 156.15



Fig.17

AA 155.17



Fig.18

AA 155.18



Fig.19

AA 155.19



Fig.20

AA 155.20



Fig.21

AA 155.21



Fig.22

AA 155.22

Verpackungseinheit: 100 Stück
Box: 100 pieces
Confezione: 100 pezzi
Confeción: 100 piezas



Fig.23

AA 155.23



Fig.24

AA 155.24



Fig.25

AA 155.25



Fig.34

AA 155.34



Fig.36

AA 155.36



SCHINK
AA 880.00
300mm / 12"

Dermatom, einstellbar von 0,1 bis 2,0mm, komplett mit auswechselbarer Klinge und 2 Spannplatten
Dermatome, adjustable from 0,1 to 2,0mm, compl. with 1 interchangeable blade and 2 skin straightening blades
Dermatomo a mano, con regolazione dello spessore da 0,1 fino a 2,0mm, compl. di 1 lama intercambiabile e 2 placche per stendere la pelle
Dermatomo, graduable de 0,1 hasta 2,0mm, compl. con 1 hoja intercambiabile y 2 placas para extender la piel



AA 880.01

Ersatzklinge allein
Spare blade only
Lama di ricambio
Hoja de repuesto

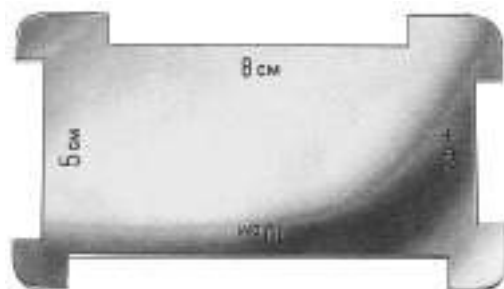

AA 880.02

Spannplatte allein
Skin straightening plate only
Placca per stendere la pelle
Placa para extender la piel





SCHEREN
SCISSORS
FORBICI
TIJERAS

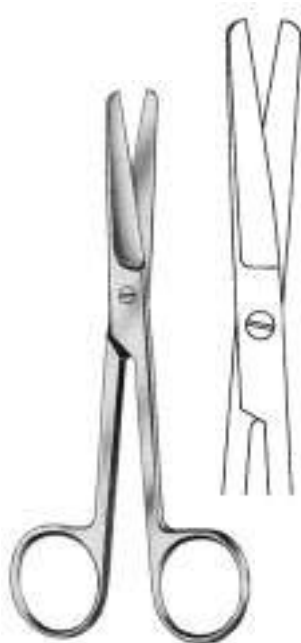

STANDARD
AA 100.10 - AA 100.20



AA 100.10
100mm / 4"



AA 100.11
110mm / 4½"



AA 100.13
130mm / 5"



AA 100.14
140mm / 5½"



AA 100.15
150mm / 6"



AA 100.16
160mm / 6½"



AA 100.18
180mm / 7"



AA 100.20
200mm / 8"

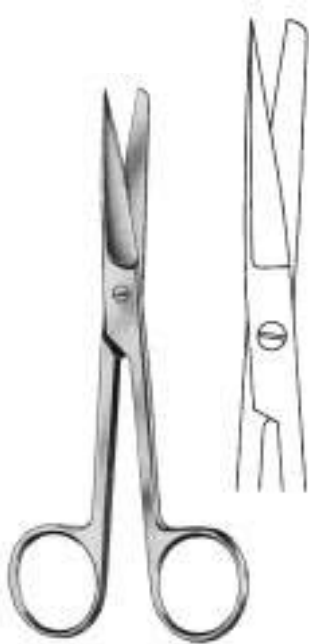

STANDARD
AA 102.10 - AA 102.20



AA 102.10
100mm / 4"



AA 102.11
110mm / 4 1/2"



AA 102.13
130mm / 5"



AA 102.14
140mm / 5 1/2"



AA 102.15
150mm / 6"



AA 102.16
160mm / 6 1/2"



AA 102.18
180mm / 7"



AA 102.20
200mm / 8"



STANDARD
AA 104.11 - AA 104.16



AA 104.11
110mm / 4½"



AA 104.13
130mm / 5"



AA 104.14
140mm / 5½"



AA 104.15
150mm / 6"



AA 104.16
160mm / 6½"

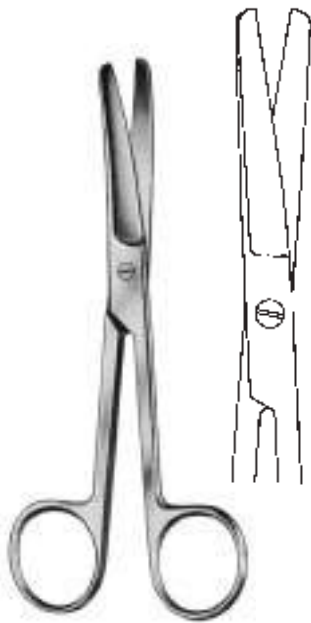

STANDARD
AA 105.11 - AA 105.20



AA 105.11
110mm / 4½"



AA 105.13
130mm / 5"



AA 105.14
140mm / 5½"



AA 105.15
150mm / 6"



AA 105.16
160mm / 6½"



AA 105.18
180mm / 7"



AA 105.20
200mm / 8"

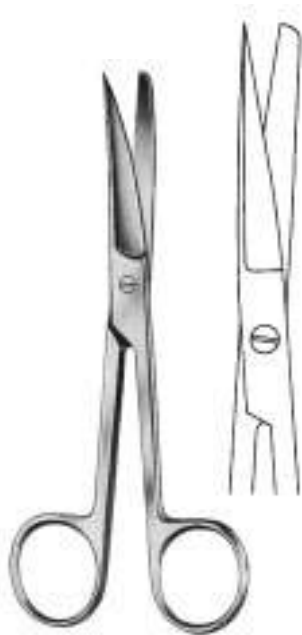

STANDARD
AA 107.11 - AA 107.20



AA 107.11
110mm / 4½"



AA 107.13
130mm / 5"



AA 107.14
140mm / 5½"



AA 107.15
150mm / 6"



AA 107.16
160mm / 6½"



AA 107.18
180mm / 7"



AA 107.20
200mm / 8"



STANDARD
AA 109.11 - AA 109.16



AA 109.11
110mm / 4½"



AA 109.13
130mm / 5"



AA 109.14
140mm / 5½"



AA 109.15
150mm / 6"



AA 109.16
160mm / 6½"



GRAZIL
AA 120.14 - AA 124.14



AA 120.14
140mm / 5½"



AA 122.14
140mm / 5½"



AA 124.14
140mm / 5½"



GRAZIL
AA 125.14 - AA 129.14



AA 125.14
140mm / 5½"



AA 127.14
140mm / 5½"



AA 129.14
140mm / 5½"



RICHTER
AA 134.14
140mm / 5½"



RICHTER
AA 135.14
140mm / 5½"



AA 136.14
140mm / 5½"

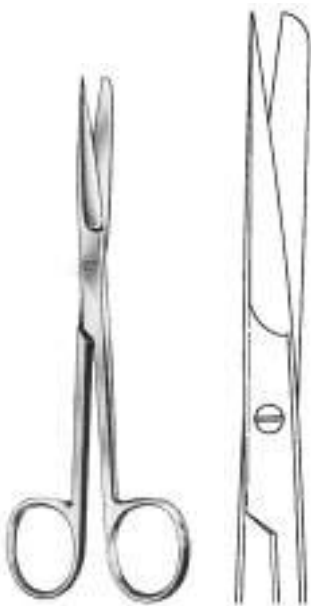
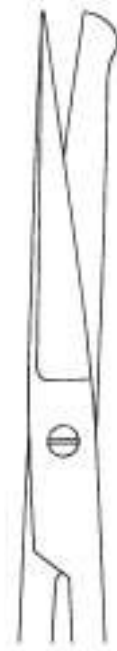

DEAVER
AA 140.14 - AA 141.14
140mm / 5½"



AA 140.14



AA 141.14



MAYO
AA 170.14 - AA 171.23



AA 170.14
140mm / 5½"



AA 170.15
150mm / 6"



AA 170.17
170mm / 6¾"



AA 170.23
230mm / 9"



AA 171.14
140mm / 5½"



AA 171.15
150mm / 6"



AA 171.17
170mm / 6¾"

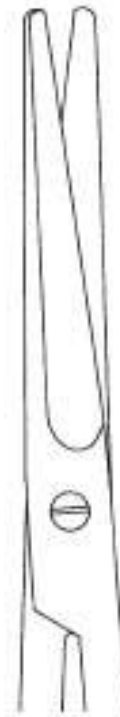

AA 171.23
230mm / 9"



MAYO WILLIAM JAMES, * 1861, † 1939
MAYO CHARLES HORACE, * 1865, † 1939

Amerikanische Chirurgen, Rochester Minnesota
Surgeon american, Rochester Minnesota
Chirurghi americani, Rochester Minnesota
Cirujanos americanos, Rochester Minnesota

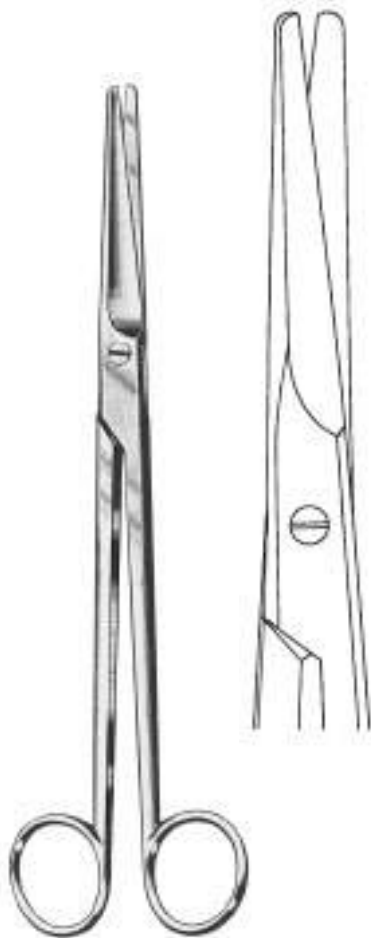

MAYO - HARRINGTON
AA 174.22 - AA 175.30



AA 174.22
220mm / 9"



AA 175.22
220mm / 9"



AA 175.30
300mm / 12"

MAYO ROBSON, * 1853, † 1933

Chirurg in Leeds (England)
Surgeon in Leeds (England)
Chirurgo a Leeds (Inghilterra)
Cirujano en Leeds (Inglaterra)

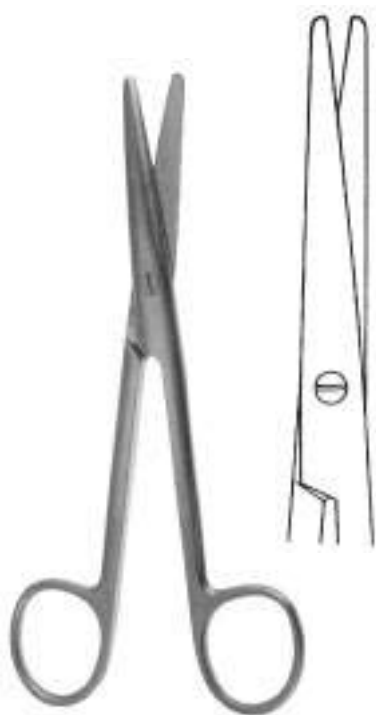

MAYO - STILLE
AA 180.15 - AA 181.17



AA 180.15
150mm / 6"



AA 180.17
170mm / 6 3/4"



AA 181.15
150mm / 6"



AA 181.17
170mm / 6 3/4"

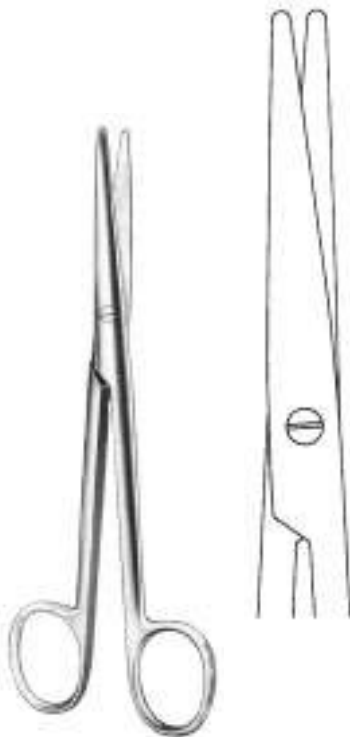

MAYO - STILLE
AA 184.16 - AA 185.21



AA 184.16
160mm / 6 $\frac{1}{4}$ "



AA 184.19
190mm / 7 $\frac{1}{2}$ "



AA 184.21
210mm / 8 $\frac{1}{4}$ "



AA 185.16
160mm / 6 $\frac{1}{4}$ "



AA 185.19
190mm / 7 $\frac{1}{2}$ "



AA 185.21
210mm / 8 $\frac{1}{4}$ "

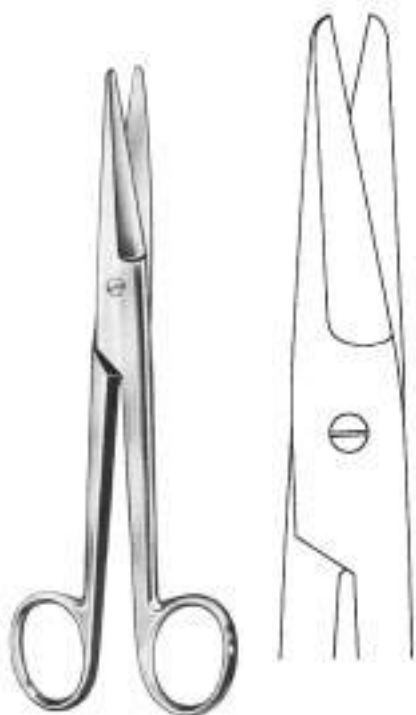

MAYO - NOBEL
AA 190.17 - AA 191.17
170mm / 6 $\frac{3}{4}$ "

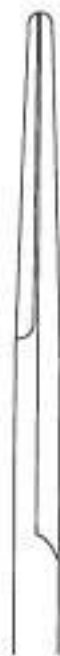

AA 190.17



AA 191.17

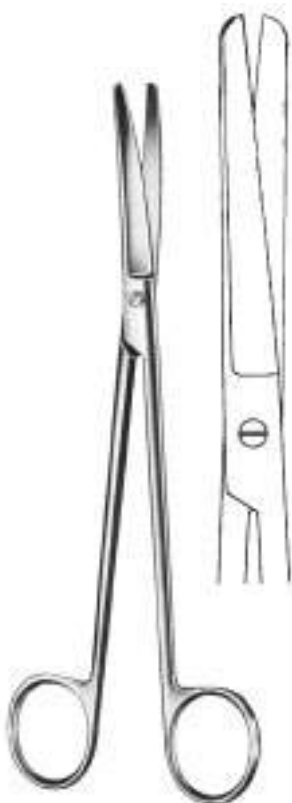

WERTHEIM
AA 195.14 - AA 195.22



AA 195.14
140mm / 5 $\frac{1}{2}$ "



AA 195.19
190mm / 7 $\frac{1}{4}$ "



AA 195.22
220mm / 9"

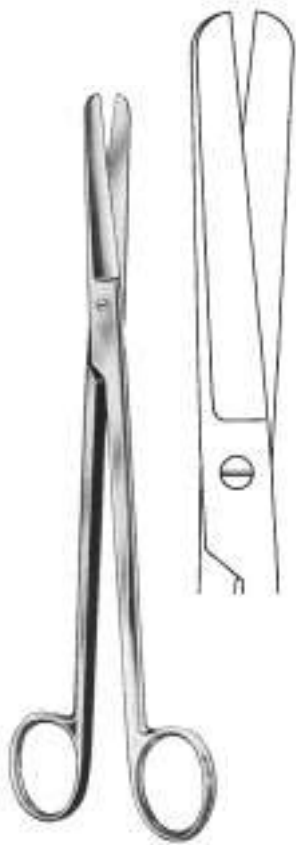

SIMS
AA 200.20 - AA 203.23



AA 200.20
200mm / 8"



AA 200.23
230mm / 9"



AA 203.20
200mm / 8"



AA 203.23
230mm / 9"



SIEBOLD
AA 205.24
240mm / 9½"

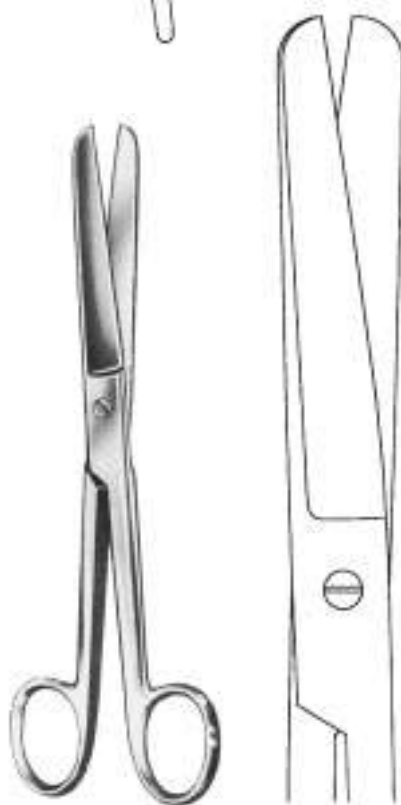
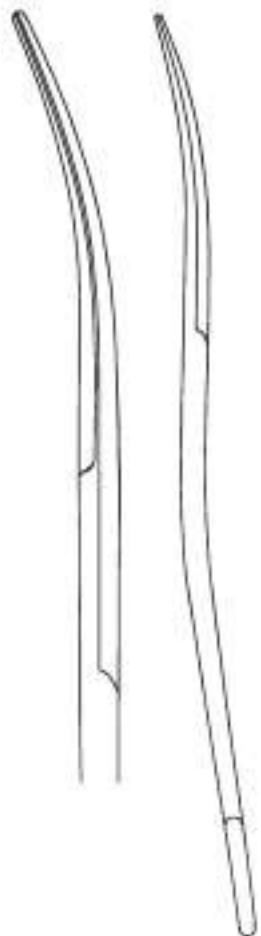

DOYEN
AA 208.17 - AA 209.17
170mm / 6¾"



AA 208.17



AA 209.17



KELLY
AA 226.16 - AA 227.18



AA 226.16
160mm / 6½"



AA 226.18
180mm / 7"



AA 227.16
160mm / 6½"



AA 227.18
180mm / 7"



METZENBAUM
AA 248.11
110mm / 4½"



METZENBAUM
AA 249.11
110mm / 4½"



METZENBAUM
AA 250.14 - AA 259.14
 140mm / 5½"



AA 250.14



AA 252.14



AA 254.14



AA 255.14



AA 257.14



AA 259.14



METZENBAUM
AA 264.15 - AA 265.15
 150mm / 6"



AA 264.15



AA 265.15

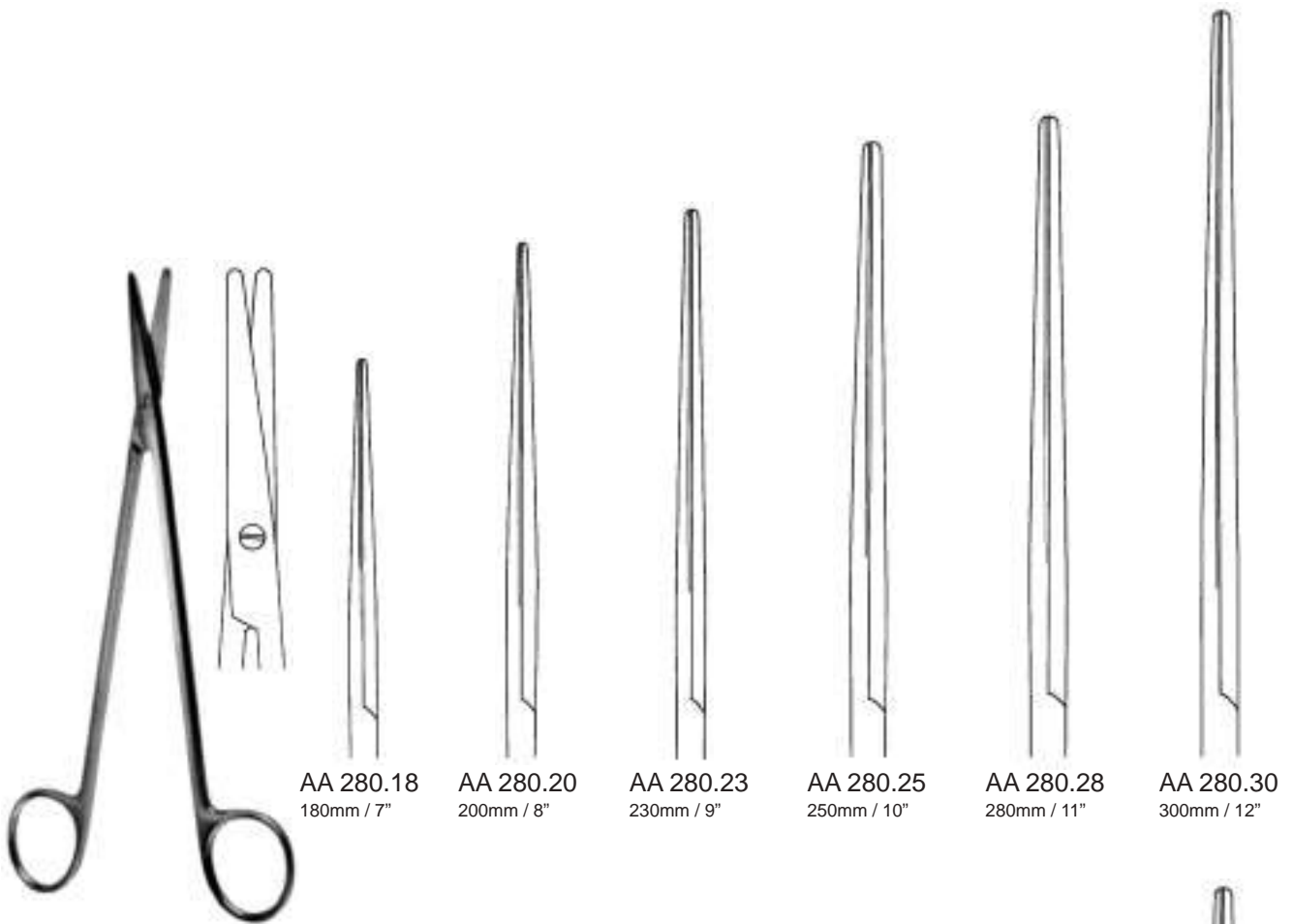

AA 280.18
180mm / 7"

AA 280.20
200mm / 8"

AA 280.23
230mm / 9"

AA 280.25
250mm / 10"

AA 280.28
280mm / 11"

AA 280.30
300mm / 12"

METZENBAUM - NELSON
AA 280.18 - AA 280.30

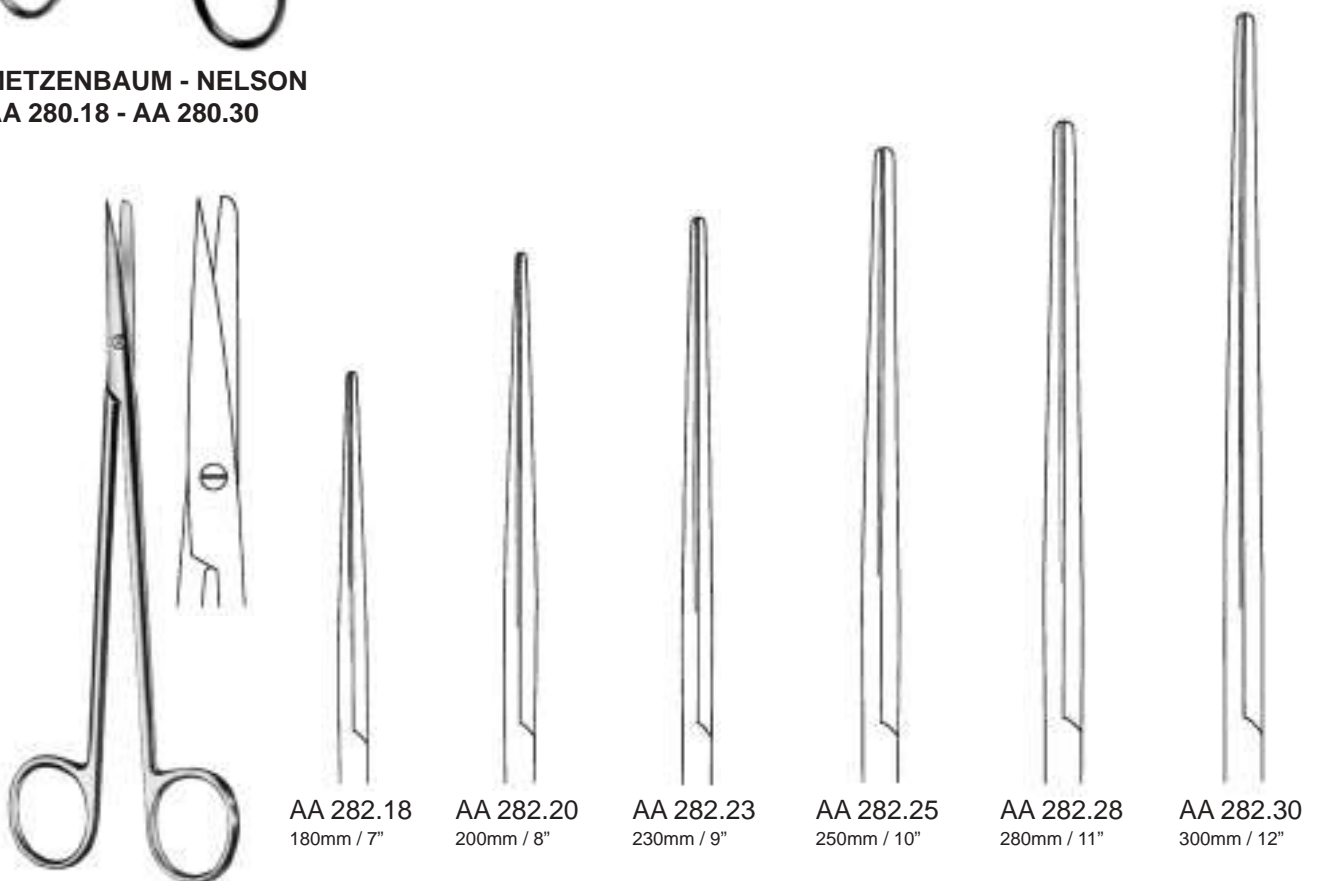

AA 282.18
180mm / 7"

AA 282.20
200mm / 8"

AA 282.23
230mm / 9"

AA 282.25
250mm / 10"

AA 282.28
280mm / 11"

AA 282.30
300mm / 12"

METZENBAUM - NELSON
AA 282.18 - AA 282.30

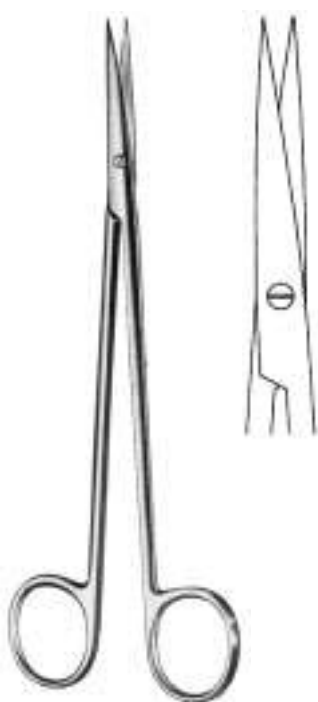

METZENBAUM - NELSON
AA 284.18 - AA 284.30



AA 284.18
180mm / 7"



AA 284.20
200mm / 8"



AA 284.23
230mm / 9"



AA 284.25
250mm / 10"



AA 284.28
280mm / 11"



AA 284.30
300mm / 12"

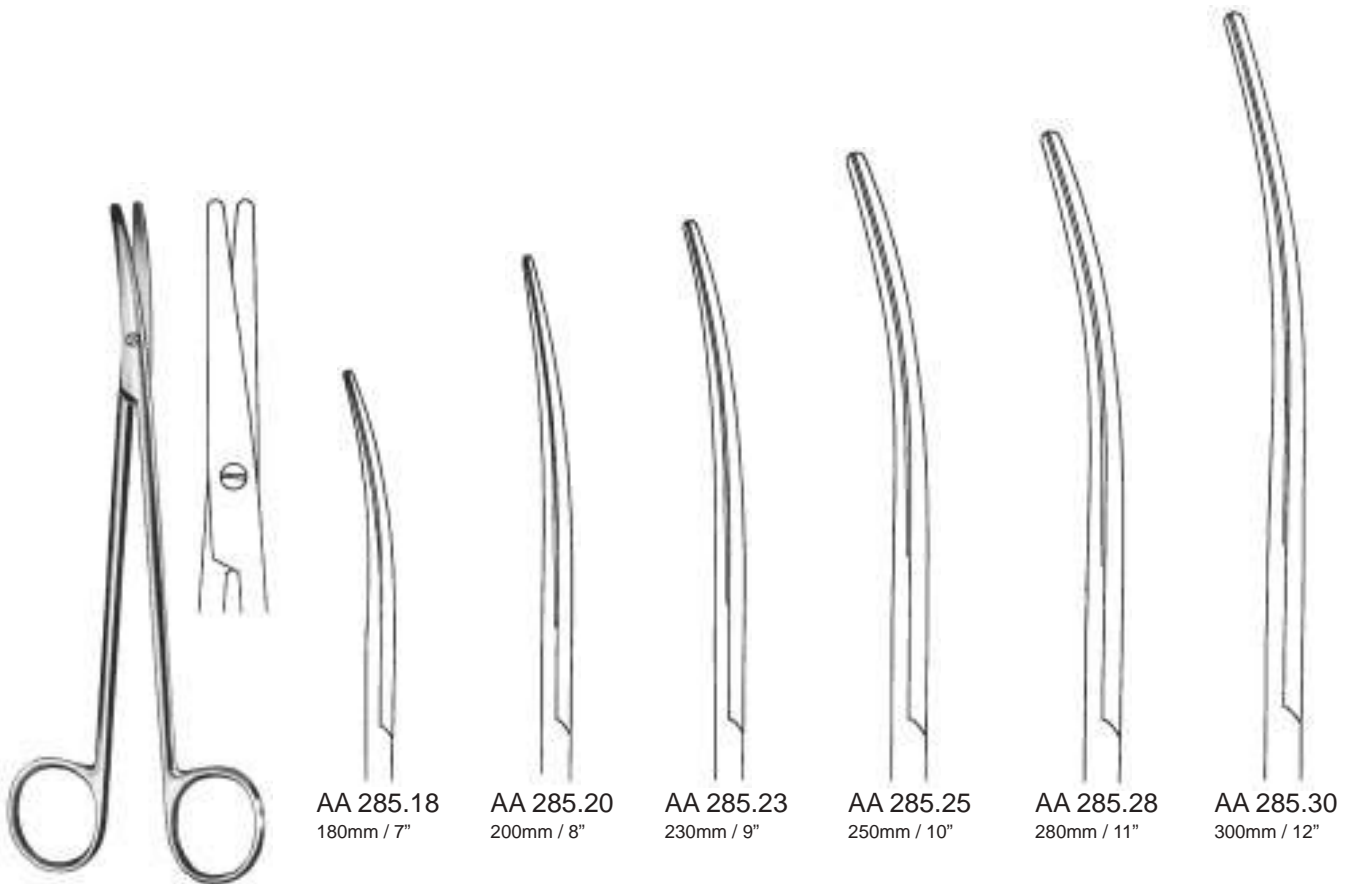

METZENBAUM - NELSON
AA 285.18 - AA 285.30

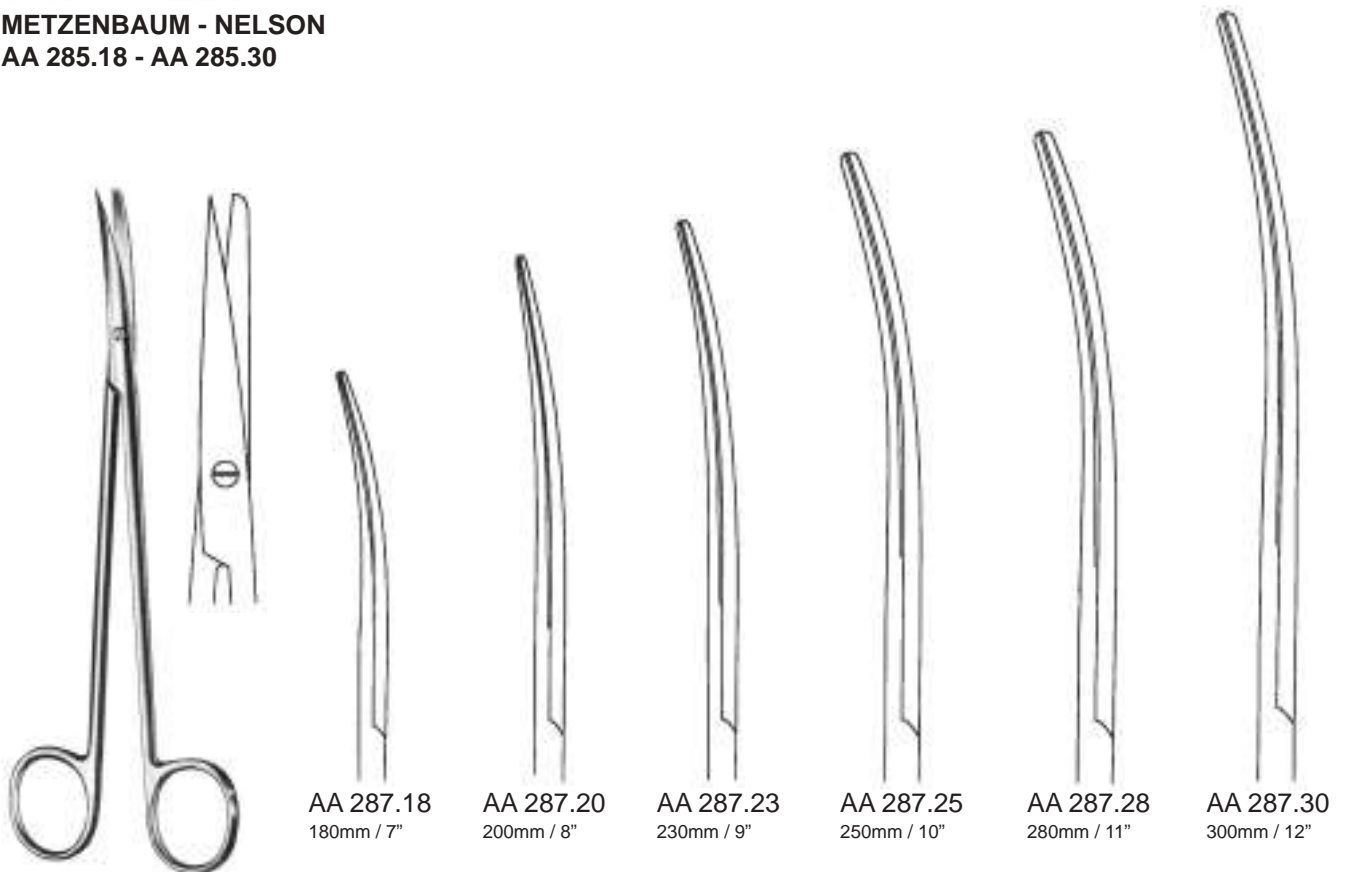

METZENBAUM - NELSON
AA 287.18 - AA 287.30

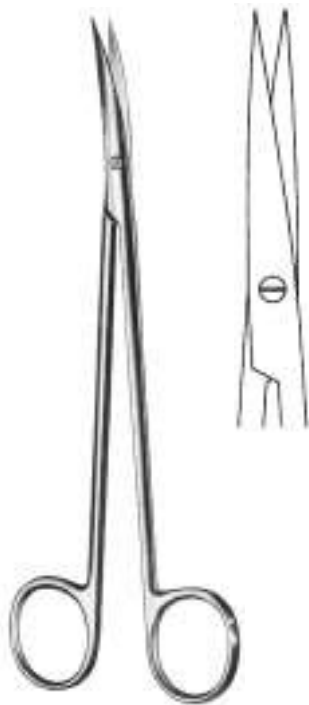

METZENBAUM - NELSON
AA 289.18 - AA 289.30



AA 289.18
180mm / 7"



AA 289.20
200mm / 8"



AA 289.23
230mm / 9"



AA 289.25
250mm / 10"



AA 289.28
280mm / 11"



AA 289.30
300mm / 12"



METZENBAUM
AA 298.14 - AA 299.14
140mm / 5½"



AA 298.14



gezahnt
saw edges
dentellata
dentellata



AA 299.14

gezahnt
saw edges
dentellata
dentellata



AA 300.15 - AA 301.15
150mm / 6"



AA 300.15



AA 301.15

Nerv - Präparierscheren,
Nerve Dissecting Scissors,
Forbici per nervi,
Tijeras para nervios

Schneiden sind außen halbscharf und Innenseite gezahnt.
Blades are outside semi-sharp and inside serrated.
Le lame sono esternamente semitaglienti mentre internamente dentellate.
Los filos son semi-cortantes en el exterior y dentados en el interior.



GORNEY
AA 306.12 - AA 307.19



AA 306.12
120mm / 4 $\frac{1}{2}$ "



AA 306.19
190mm / 7 $\frac{1}{2}$ "



AA 307.19
190mm / 7 $\frac{1}{2}$ "

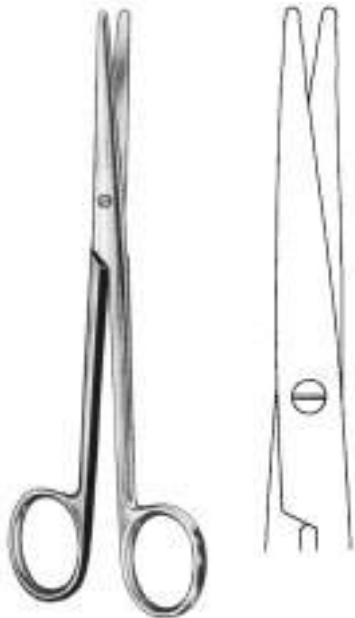

AA 310.16



AA 311.16

LEXER
AA 310.16 - AA 311.16
160mm / 6½"



LEXER - BABY
AA 320.10
100mm / 4"



LEXER - BABY
AA 321.10
100mm / 4"



LEXER - FINO
AA 324.16
160mm / 6½"



LEXER - FINO
AA 325.16
160mm / 6½"



METZENBAUM
AA 326.14
140mm / 5½"



METZENBAUM
AA 327.14
140mm / 5½"



METZENBAUM
AA 328.14
140mm / 5½"



METZENBAUM
AA 329.14
140mm / 5½"

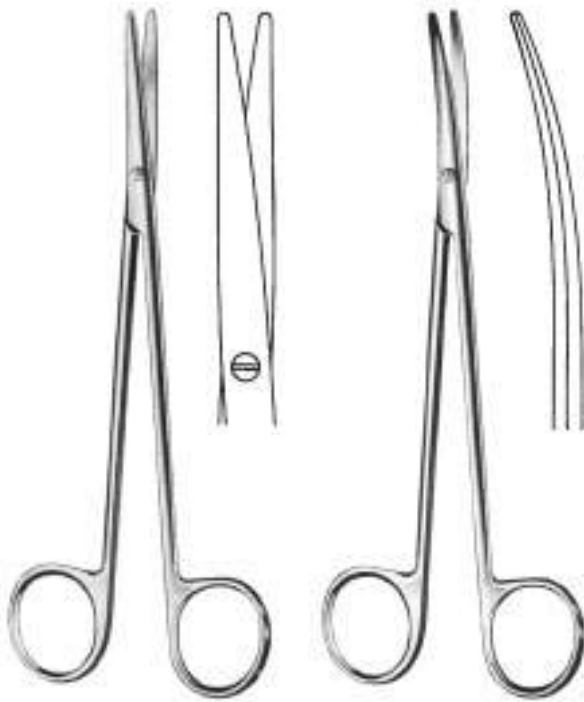

METZENBAUM
AA 330.18 // 180mm / 7"
AA 330.20 // 200mm / 8"
AA 330.23 // 230mm / 9"

METZENBAUM
AA 331.18 // 180mm / 7"
AA 331.20 // 200mm / 8"
AA 331.23 // 230mm / 9"



METZENBAUM
AA 332.18 // 180mm / 7"
AA 332.20 // 200mm / 8"
AA 332.23 // 230mm / 9"

METZENBAUM
AA 333.18 // 180mm / 7"
AA 333.20 // 200mm / 8"
AA 333.23 // 230mm / 9"

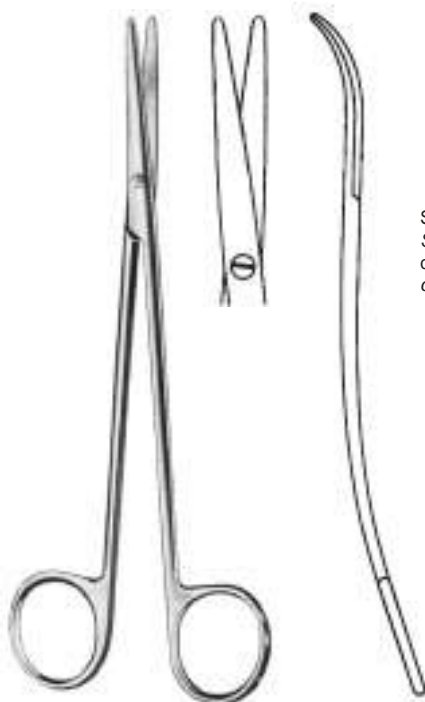

S-förmig gebogen
S-shaped
 curve in S
curvas en S

METZENBAUM
AA 335.18 // 180mm / 7"
AA 335.20 // 200mm / 8"
AA 335.23 // 230mm / 9"

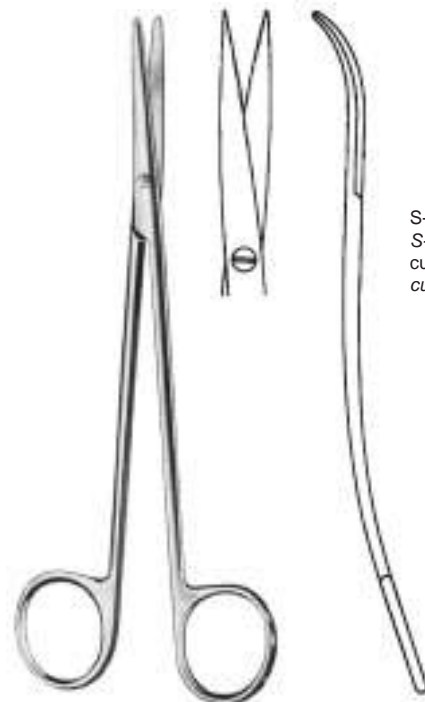

S-förmig gebogen
S-shaped
 curve in S
curvas en S

METZENBAUM
AA 337.18 // 180mm / 7"
AA 337.20 // 200mm / 8"
AA 337.23 // 230mm / 9"

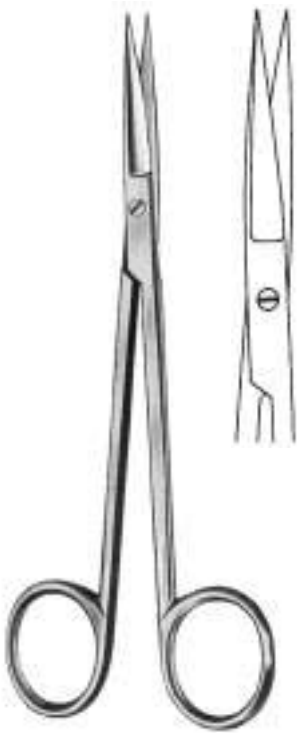

AA 340.14

AA 341.14

SANVENERO
 AA 340.14 - AA 341.14
 140mm / 5½"



AA 344.11

AA 345.11

AA 344.11 - AA 345.11
 110mm / 4¾"

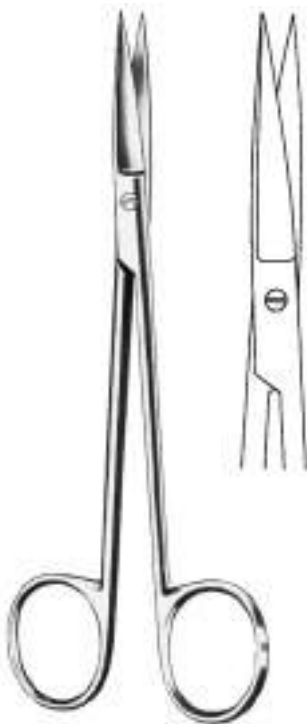

AA 350.14

AA 351.14

JOSEPH
 AA 350.14 - AA 351.14
 140mm / 5½"



CHADWICK
 AA 353.11
 110mm / 4¾"



KILNER (RAGNELL)
 AA 359.12 - AA 359.15

AA 359.12
 120mm / 4¾"

AA 359.15
 150mm / 6"



BROPHY (SULLIVAN)
 AA 360.14
 140mm / 5½"



BROPHY (SULLIVAN)
 AA 361.14
 140mm / 5½"



AA 362.14 - AA 363.14
 140mm / 5½"

AA 362.14

AA 363.14



REYNOLDS
 AA 364.15 - AA 365.15
 150mm / 6"

AA 364.15

AA 365.15



SHEA
 AA 367.12
 120mm / 4¾"



CRAFOORD
AA 371.30
300mm / 12"



THOREK
AA 373.19 - AA 373.25

AA 373.19
190mm / 7½"

AA 373.25
250mm / 10"



SATINSKY
AA 375.24
240mm / 9½"



KLINGENBERG - LOTH
AA 379.23
230mm / 9"



MC INDOE
AA 404.19
190mm / 7½"



POTTS - SMITH
AA 405.19
190mm / 7½"



DIETRICH
 AA 380.25 - AA 381.00



25°
 AA 380.25
 180mm / 7"



45°
 AA 380.45
 180mm / 7"



60°
 AA 380.60
 180mm / 7"

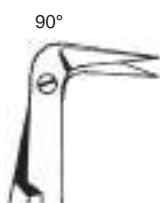

90°
 AA 380.90
 170mm / 6 1/2"



125°
 AA 381.00
 170mm / 6 1/2"



DIETRICH
 AA 381.01
 170mm / 6 1/2"



125°



POTTS - SMITH
 AA 391.25 - AA 397.60
 190mm / 7 1/2"



25°
 AA 391.25



40°
 AA 391.40



60°
 AA 391.60



60°
 AA 395.60

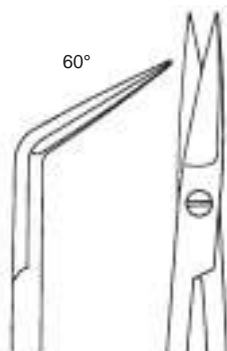

60°
 AA 397.60

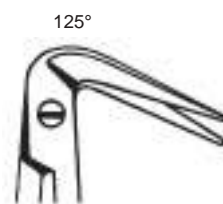

125°
 AA 393.00

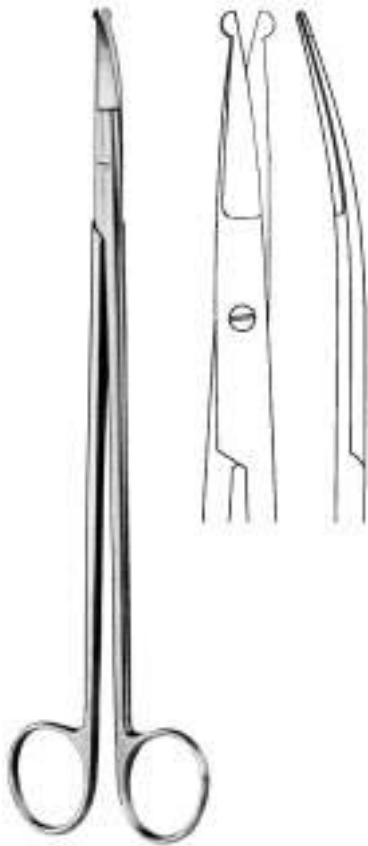

STRULLY
AA 445.22
 220mm / 8 $\frac{1}{2}$ "



DANDY
AA 451.17
 170mm / 6 $\frac{3}{4}$ "

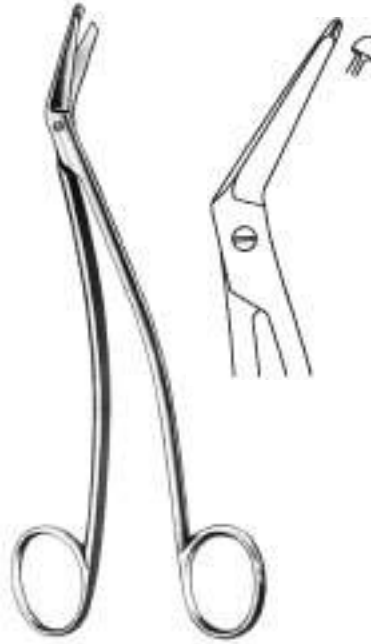

SCHMIEDEN - TAYLOR
AA 455.17
 170mm / 6 $\frac{3}{4}$ "



JAMESON
AA 457.15
 150mm / 6"



TOENNIS - ADSON
AA 459.17
 170mm / 6 $\frac{3}{4}$ "

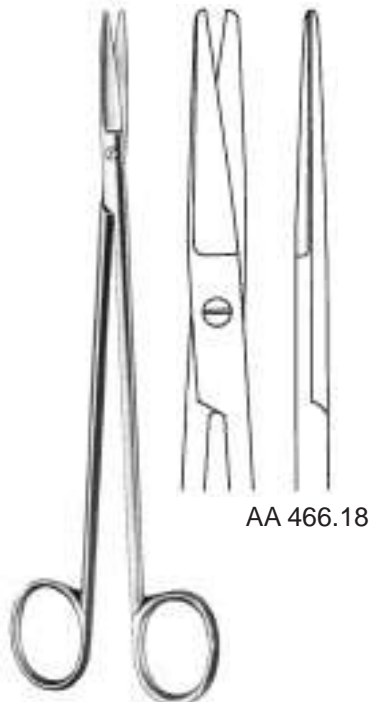

TOENNIS
AA 466.18 - AA 467.18
 180mm / 7"



AA 467.18



OLIVECRONA
AA 475.23
 230mm / 9"

Tonsillen- und Nasenscheren
Tonsil and Nasal Scissors
Forbici nasali e per tonsille
Tijeras nasales y para amígdalas



DEAN
AA 495.17 - AA 497.17
 170mm / 6³/₄"

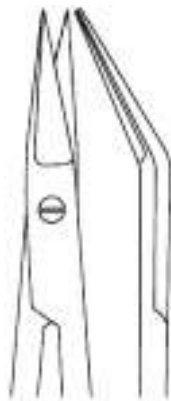

AA 495.17

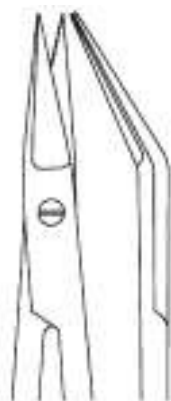

AA 497.17

gezahnt
 serrated
 dentellata
 dentadas



GOOD
AA 499.19
 190mm / 7¹/₂"



FOMON
AA 505.13
 130mm / 5"



FOMON
AA 505.14
 140mm / 5¹/₂"



FOMON
AA 507.15
 150mm / 6"



COTTLE
AA 509.16
 160mm / 6¹/₂"



HEYMANN - KNIGHT
AA 511.18
 180mm / 7"

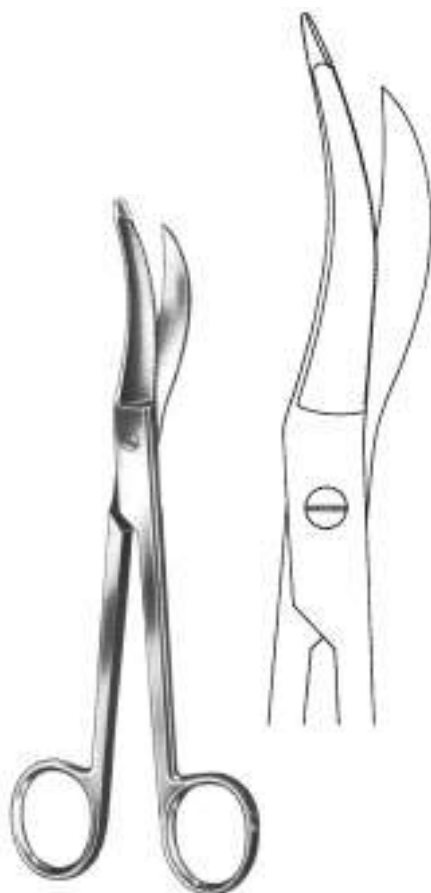

WALDMANN
AA 531.18
180mm / 7"

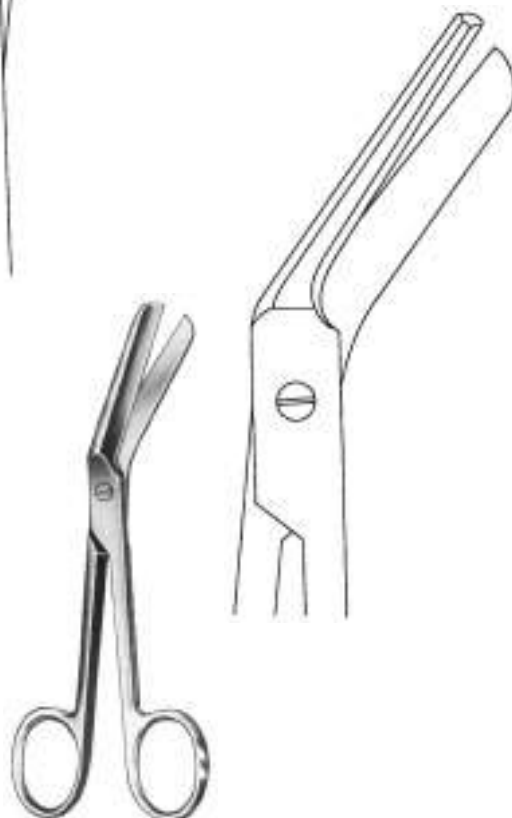

BRAUN - STADLER
AA 535.14
140mm / 5½"

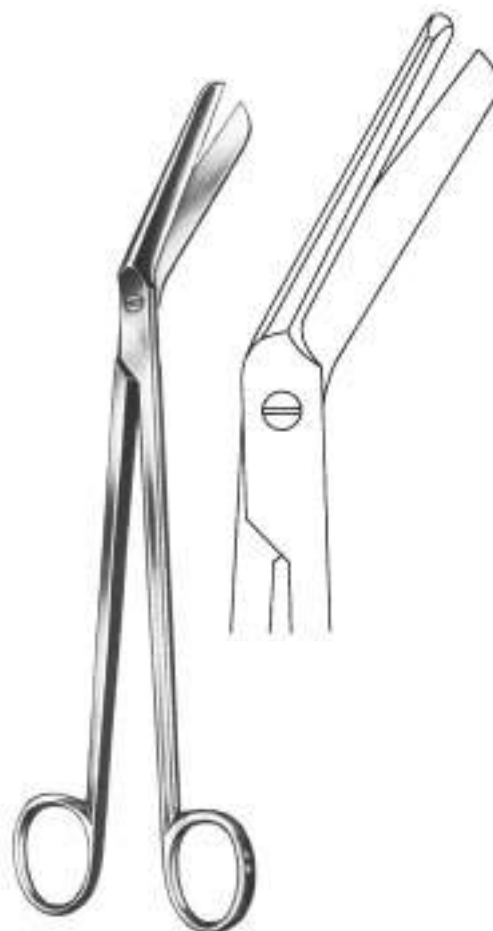

BRAUN - STADLER
AA 537.22
220mm / 8½"



MOD. USA
AA 545.10
100mm / 4"



SCHUMACHER
AA 547.16
160mm / 6½"



BUSCH
AA 551.13 - AA 551.16
130mm / 5" 160mm / 6½"



AA 553.13 - AA 553.16
130mm / 5" 160mm / 6½"

gezahnt
saw edge
dentellate
dentada

Feine chirurgische Scheren
Fine operating Scissors
 Forbici fine per chirurgia
 Tijeras finas para cirugía



GOLDMANN - FOX
AA 566.13 - AA 567.13
 130mm / 5"

AA 566.13 AA 567.13
 gezahnt, saw edge
 dentellate, *dentadas*



WAGNER
AA 570.12 - AA 571.12
 120mm / 4 3/4"

AA 570.12 AA 571.12

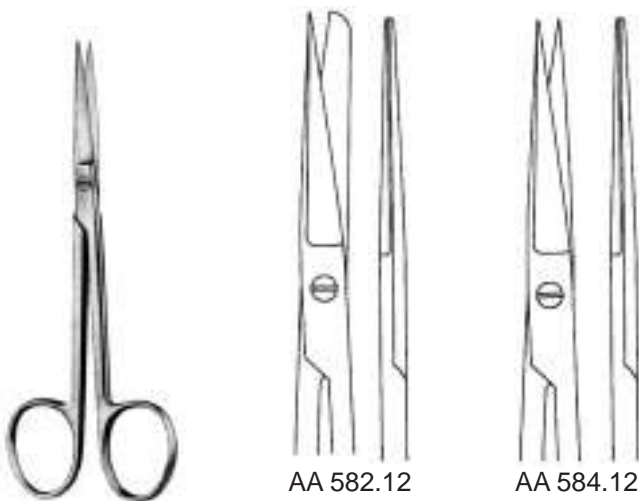

AA 582.12 - AA 589.12
 120mm / 4 3/4"

AA 582.12

AA 584.12

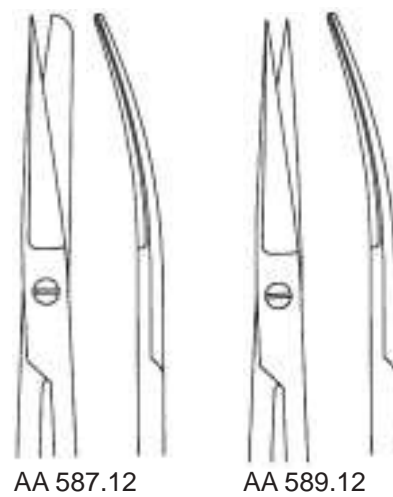

AA 587.12

AA 589.12

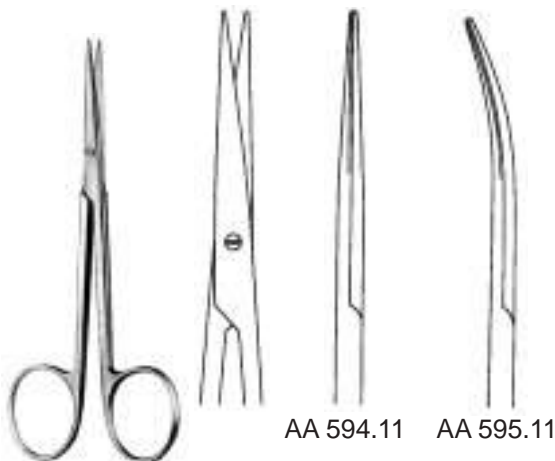

AA 594.11 - AA 595.11
 110mm / 4 1/2"

AA 594.11

AA 595.11

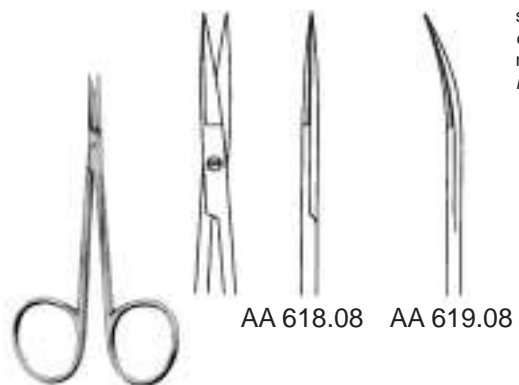

AA 618.08 - AA 619.08
 80mm / 3 1/4"

AA 618.08

AA 619.08

sehr fein
delicate
 molto fine
muy finas

extra flach
 extra plat
 estremamente piatta
 extremamente plana



AA 620.09 - AA 621.10



AA 620.09
 90mm / 3½"



AA 620.10
 100mm / 4"



AA 621.09
 90mm / 3½"



AA 621.10
 100mm / 4"



AA 622.10
 100mm / 4"



BONN
AA 624.09 - AA 625.09
 90mm / 3½"



AA 624.09



AA 625.09



AA 630.11 - AA 635.11
 110mm / 4½"



AA 630.11



AA 631.11



AA 633.11



AA 635.11



GRAEFE
AA 639.10
 100mm / 4"



AA 640.12 - AA 641.12
 120mm / 4½"



AA 640.12



AA 641.12



KNAPP
AA 652.10 - AA 657.10
 100mm / 4"

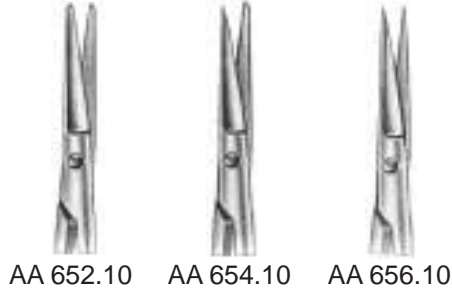

AA 652.10 AA 654.10 AA 656.10



AA 653.10 AA 655.10 AA 657.10



STEVENS
AA 680.11 - AA 681.11
 110mm / 4 1/2"

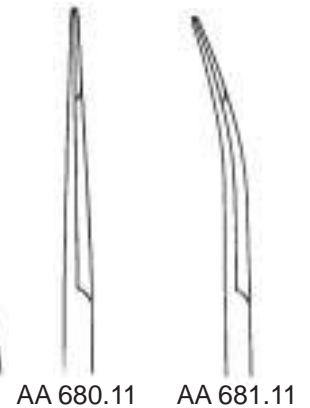

AA 680.11 AA 681.11

spitz, *pointed*
 acute, *agudas*



STEVENS
AA 682.11 - AA 683.11
 110mm / 4 1/2"

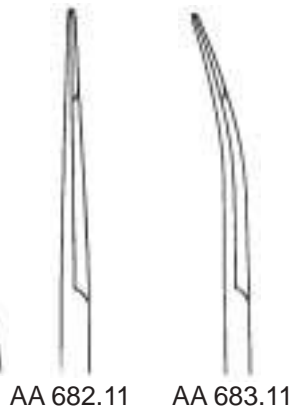

AA 682.11 AA 683.11

stumpf, *blunt*
 smusse, *romas*



GRAZIL
AA 690.11 - AA 691.11
 110mm / 4 1/2"

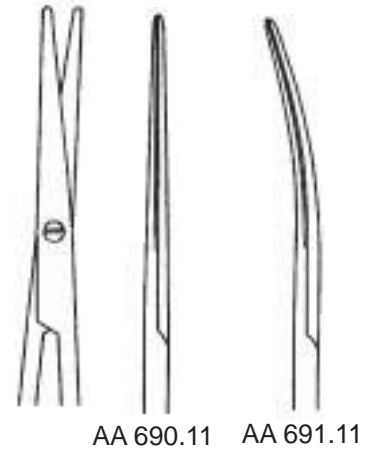

AA 690.11 AA 691.11



AA 705.11
 110mm / 4 1/2"



AA 714.11 - AA 715.13

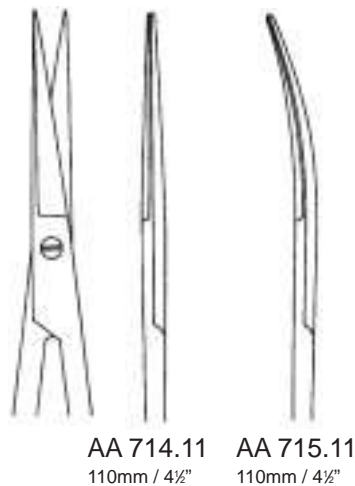

AA 714.11 AA 715.11
 110mm / 4 1/2" 110mm / 4 1/2"



AA 714.13 AA 715.13
 130mm / 5" 130mm / 5"



BEEBEE
 AA 716.10 - AA 718.10
 100mm / 4"



AA 716.10

stumpf, *blunt*
 smusse, *romas*



AA 718.10

spitz, *pointed*
 acute, *agudas*



BEEBEE
 AA 717.10 - AA 719.10
 100mm / 4"



AA 717.10

stumpf, *blunt*
 smusse, *romas*



AA 719.10

spitz, *pointed*
 acute, *agudas*



BEEBEE
 AA 720.12 - AA 721.12
 120mm / 4 3/4"



AA 720.10



AA 721.10

gezahnt, *saw edge*
 dentellate, *dentadas*



AA 732.23 - AA 735.23
 230mm / 9"



Jacobson
 AA 732.23



Potts
 AA 733.23



AA 734.23



AA 735.23



AA 736.19 - AA 739.19
 190mm / 7½"



AA 736.19



AA 737.19



AA 739.19



WESTCOTT
AA 740.11 - AA 741.11
 110mm / 4½"



AA 740.11



AA 741.11



AA 748.19 - AA 749.19
 190mm / 7½"



AA 748.19



AA 749.19





AA 750.19 - AA 753.19
 190mm / 7½"



AA 750.19



AA 751.19

aufgebogen
 curved
 curva
 curva



AA 752.19

abgebogen
 curved downward
 curva verso il basso
 curva hacia abajo



AA 753.19

abgewinkelt
 angled
 angolata
 acodada



AA 755.11
 110mm / 4½"



AA 756.12
 120mm / 4½"



GOMEL
AA 757.14 - AA 757.16



AA 757.14
 140mm / 5½"



AA 757.16
 160mm / 6½"



HEPP/SCHIEDEL
AA 759.14 - AA 759.16



AA 759.14
 140mm / 5½"



AA 759.16
 160mm / 6½"



AA 760.09
 90mm / 3½"



AA 761.09
 90mm / 3½"





AA 770.25 - AA 771.00
180mm / 7"

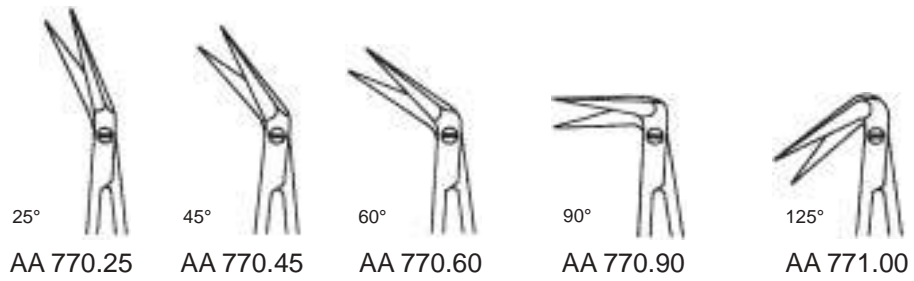

AA 771.25 - AA 772.00
180mm / 7"

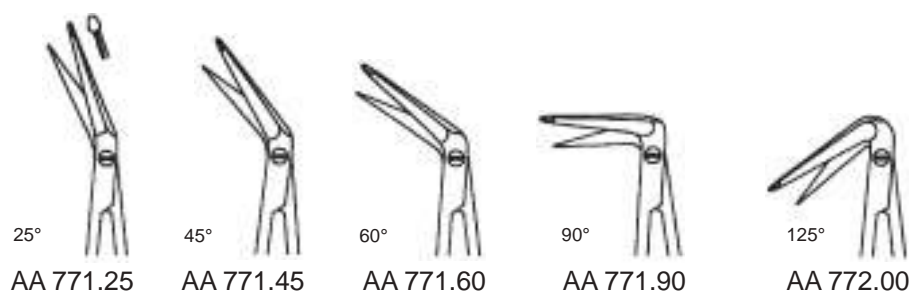

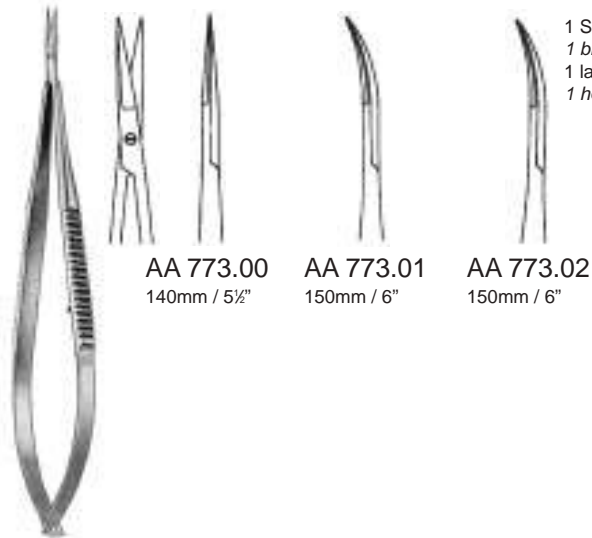

AA 773.00
140mm / 5½"

AA 773.01
150mm / 6"

AA 773.02
150mm / 6"

1 Schneide gezahnt
 1 blade saw edge
 1 lama dentellata
 1 hoja dentada

AA 773.00 - AA 773.02

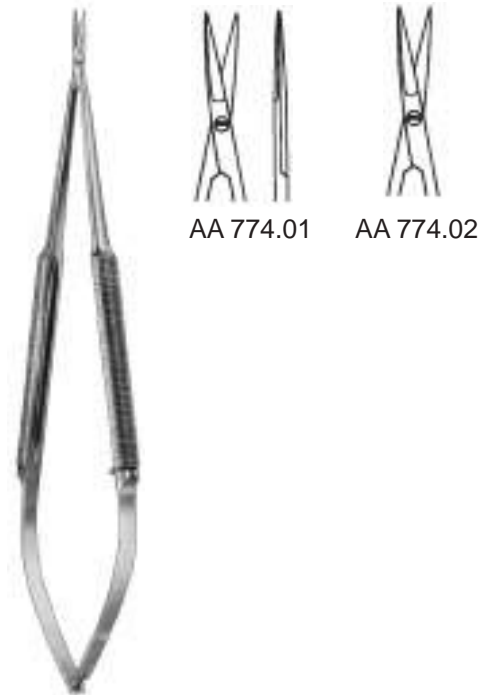

AA 774.01

AA 774.02

AA 774.01 - AA 774.02
180mm / 7"



HEPP/SCHIEDEL
AA 774.06
180mm / 7"



AA 775.01
180mm / 7"



HEPP/SCHIEDEL
AA 775.03
180mm / 7"

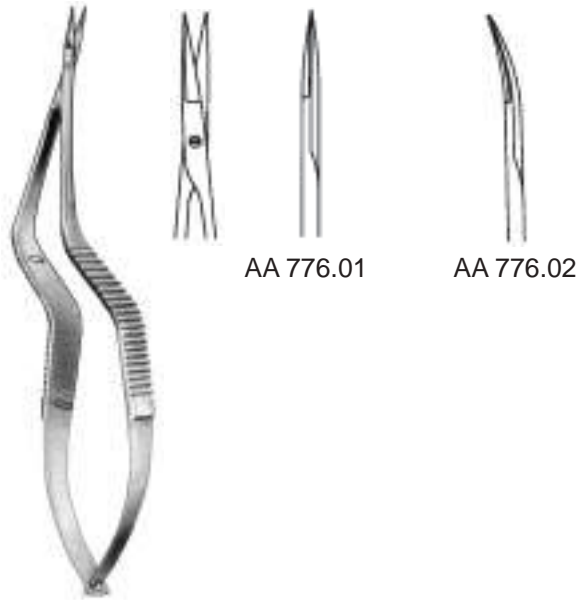

AA 776.01 - AA 776.02
150mm / 6"

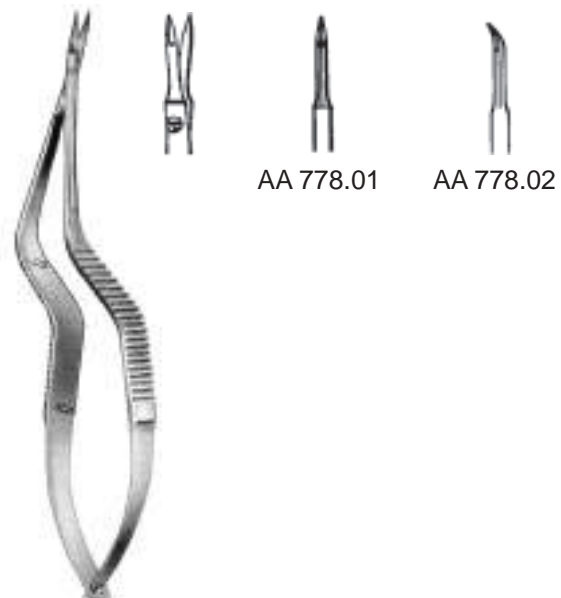

AA 778.01 - AA 778.02
150mm / 6"

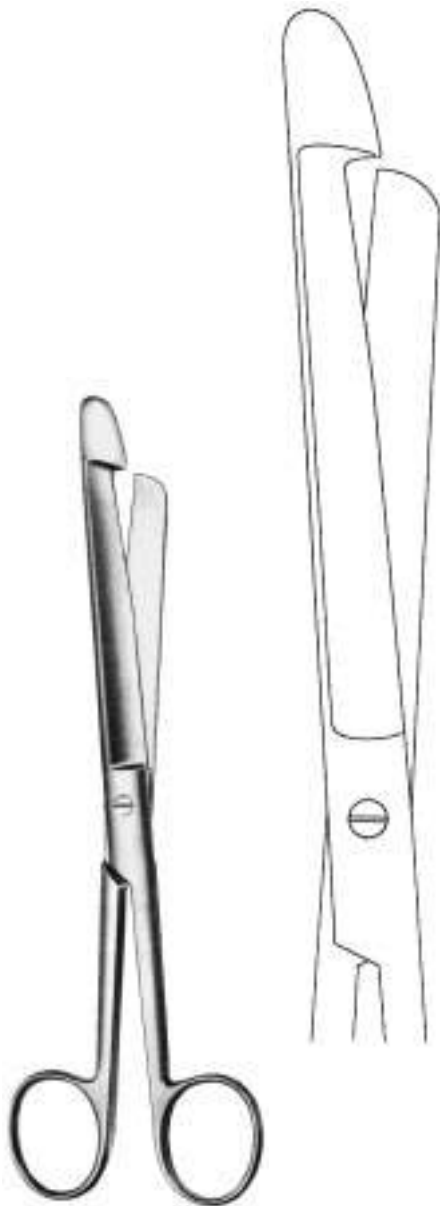

AA 782.21
210mm / 8 $\frac{1}{4}$ "



AA 784.21
210mm / 8 $\frac{1}{4}$ "



NORTHBENT
AA 819.13
 130mm / 5"



LITTLER
AA 821.11
 110mm / 4½"



SPENCER
AA 824.09
 90mm / 3½"



SPENCER
AA 824.13
 130mm / 5"



AA 827.11
 110mm / 4½"



BUCK
AA 830.14 - AA 830.17



AA 830.14
 140mm / 5½"



AA 830.17
 170mm / 6¾"



LITTAUER
AA 834.14
 140mm / 5½"



SCHOEMAKER - LOTH
AA 838.13
 130mm / 5"



EISELSBERG
AA 840.12
 120mm / 4¾"



UNIVERSAL
AA 806.14 - AA 809.14
 140mm / 5½"



UNIVERSAL
AA 806.16 - AA 809.16
 160mm / 6½"



UNIVERSAL
AA 806.18 - AA 809.18
 180mm / 7"

schwarz	<i>black</i>	nero	<i>negro</i>	AA 806.14
blau	<i>blue</i>	blu	<i>azul</i>	AA 807.14
rot	<i>red</i>	rosso	<i>rajo</i>	AA 808.14
grün	<i>green</i>	verde	<i>verde</i>	AA 809.14

AA 806.16
AA 807.16
AA 808.16
AA 809.16

AA 806.18
AA 807.18
AA 808.18
AA 809.18

SIR JOSEPH LISTER, * 1827, † 1912

Chirurg des königlich englischen Hofes.
Surgeon from the real english family.
 Chirurgo della famiglia reale inglese.
Cirujano de la familia real inglesa.



ESMARCH
AA 805.20
 200mm / 8"



LISTER
AA 835.14 / 140mm / 5½"
AA 835.16 / 160mm / 6½"
AA 835.18 / 180mm / 7"
AA 835.20 / 200mm / 8"



LANGE
AA 850.18
 180mm / 7"



LORENZ
AA 855.23
 230mm / 9"



KNOWLES
AA 860.14
 140mm / 5½"

für Finger
 for fingers
 per dita
 para dedos



LISTER - EXCENTRIC
AA 877.16 / 160mm / 6½"
AA 877.19 / 190mm / 7½"



BRUNS
AA 883.24 - AA 884.24
 240mm / 9½"



AA 883.24
 gezahnt
 saw edges
 dentellate
 dentadas

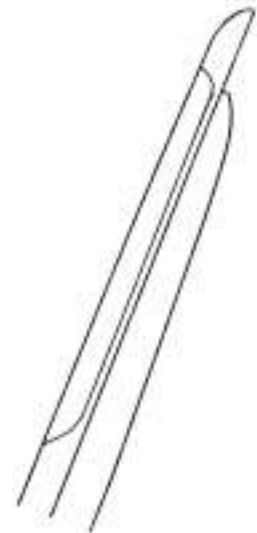

AA 884.24
 glatt
 smooth
 lisce
 lisas

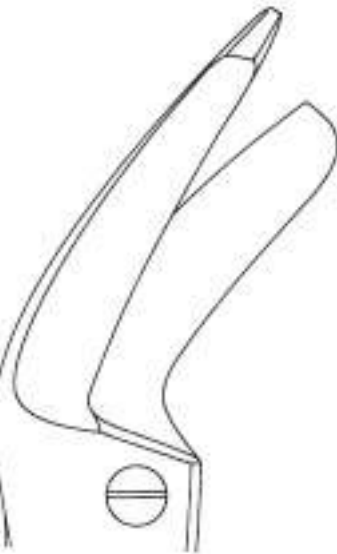

Wellenschliff
undulated cutting edge
 filo ondulato
 filo ondulado

TORNADO
AA 885.24
 240mm / 9½"

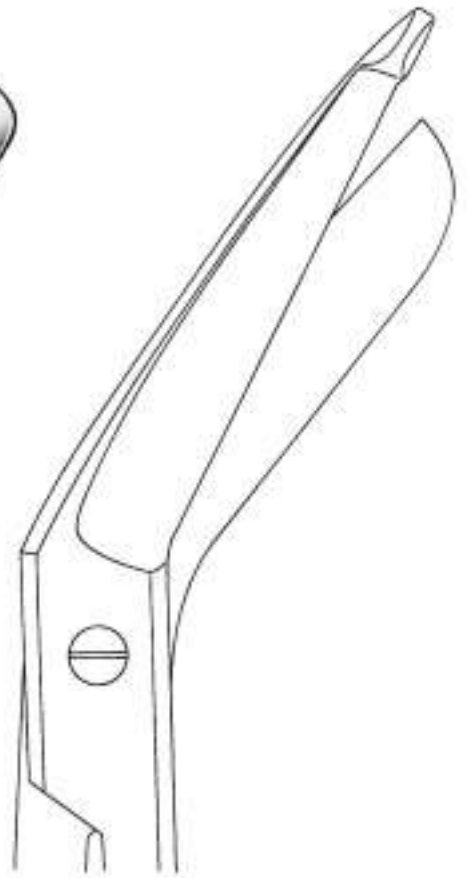

BERGMANN
AA 895.23
 230mm / 9"

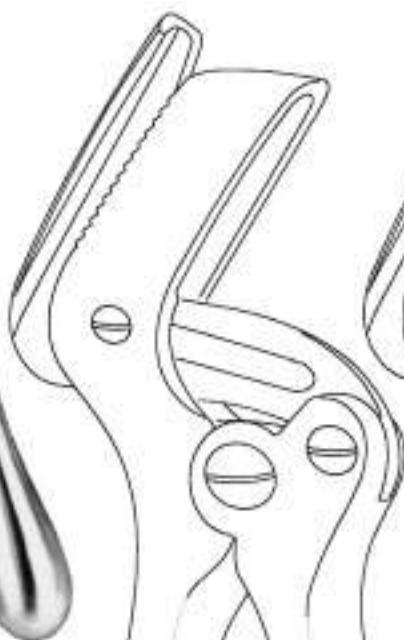

AA 887.23
 230mm / 9"

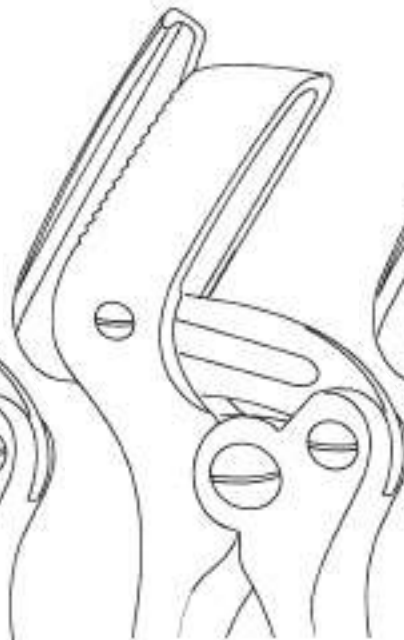

AA 887.26
 260mm / 10¼"

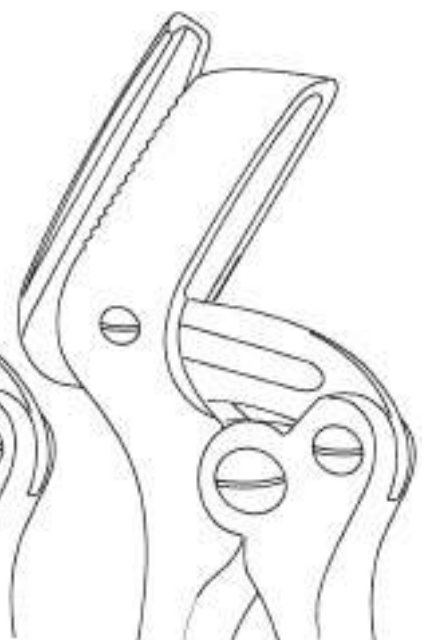

AA 887.37
 370mm / 14½"

STILLE
AA 887.23 - AA 887.37

CT - ORO



LISTER
AA 891.18
180mm / 7"

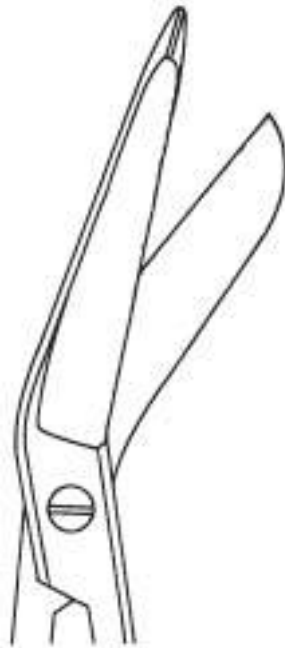

BRUNS
AA 897.24
240mm / 9½"

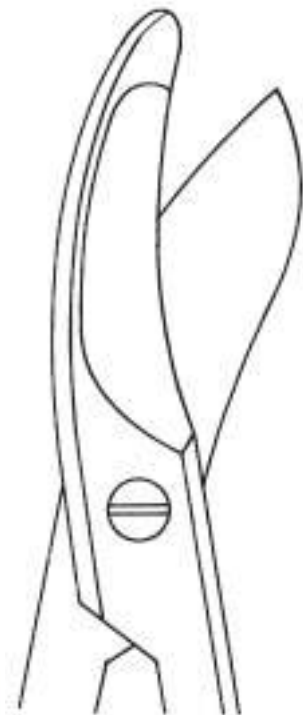



MAYO - STILLE
HA 180.15 - HA 181.17



HA 180.15
150mm / 6"



HA 181.15
150mm / 6"



HA 180.17
170mm / 6 3/4"



HA 181.17
170mm / 6 3/4"

gezahnt
 saw edge
 dentellate
 dentadas



gerade
 straight
 rette
 rectas

gebogen
 curved
 curve
 curvas

STANDARD

HA 102S14

140mm / 5½"

HA 107S14



gerade
 straight
 rette
 rectas

gebogen
 curved
 curve
 curvas

MAYO

HA 170S14

140mm / 5½"

HA 170S17

170mm / 6¾"

HA 170S23

230mm / 9"

HA 171S14

HA 171S17

HA 171S23



gerade
 straight
 rette
 rectas

gebogen
 curved
 curve
 curvas

MAYO - STILLE

HA 180S15

150mm / 6"

HA 180S17

170mm / 6¾"

HA 181S15

HA 181S17

gezahnt
saw edge
 dentellate
 dentadas



gerade
straight
 rette
 rectas

gebogen
curved
 curve
 curvas

SIMS

HA 200S20

200mm / 8"
 230mm / 9"

HA 203S20
HA 203S23



SIEBOLD
HA 215S24
 240mm / 9½"



gerade
straight
 rette
 rectas

gebogen
curved
 curve
 curvas

BABY - METZENBAUM

HA 248S11

110mm / 4½"

HA 249S11



gerade
straight
 rette
 rectas

gebogen
curved
 curve
 curvas

METZENBAUM - FINO

HA 250S14

140mm / 5½"

HA 251S14

gezahnt
 saw edge
 dentellate
 dentadas



gerade
 straight
 rette
 rectas

gebogen
 curved
 curve
 curvas

METZENBAUM - NELSON

- HA 280S14 140mm / 5½"
- HA 280S18 180mm / 7"
- HA 280S20 200mm / 8"
- HA 280S23 230mm / 9"

- HA 281S14
- HA 281S18
- HA 281S20
- HA 281S23



gerade
 straight
 rette
 rectas

gebogen
 curved
 curve
 curvas

LEXER

- HA 310S16 160mm / 6½"

- HA 311S16



gebogen
 curved
 curve
 curvas

METZENBAUM - FINO

- HA 331S18 180mm / 7"
- HA 331S23 230mm / 9"



gerade
 straight
 rette
 rectas

gebogen
 curved
 curve
 curvas

REYNOLDS

- HA 364S15 150mm / 6"

- HA 365S13
- HA 365S15

gezahnt
saw edge
 dentellate
 dentadas



POTTS - SMITH
 HA 391S25 - HA 391S60
 190mm / 7½"



25°
 HA 391S25



40°
 HA 391S40



60°
 HA 391S60



gerade
straight
 rette
 rectas

gebogen
curved
 curve
 curvas

STEVENS

HA 440S11

110mm / 4½"

HA 441S11

gezahnt
saw edge
dentellate
dentadas



**FOMON
HA 505S13**
130mm / 5"



**FOMON
HA 507S13**
130mm / 5"



**FOMON
HA 508S13**
130mm / 5"



**COTTLE
HA 509S16**
160mm / 6½"



**WALDMANN
HA 531S18**
180mm / 7"



**HEYMANN
HA 511S18**
180mm / 7"



BRAUN - STADLER
HA 535S14 140mm / 5½"
HA 535S22 220mm / 8¾"

gezahnt
saw edge
dentellate
dentadas

gerade
straight
rette
rectas



WAGNER

HA 570S12

120mm / 4 $\frac{1}{2}$ "

gebogen
curved
curve
curvas

HA 571S12

gerade
straight
rette
rectas



HA 592S11

110mm / 4 $\frac{1}{2}$ "

gebogen
curved
curve
curvas

HA 593S11

gerade
straight
rette
rectas



HA 630S11

110mm / 4 $\frac{1}{2}$ "

gebogen
curved
curve
curvas

HA 631S11

gerade
straight
rette
rectas

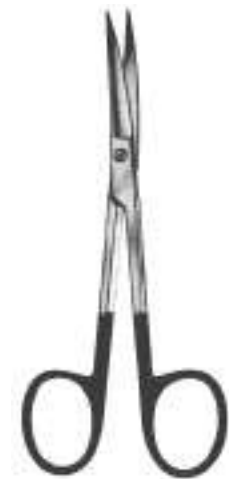

HA 640S12

120mm / 4 $\frac{1}{2}$ "

gebogen
curved
curve
curvas

HA 641S12

gezahnt
 saw edge
 dentellate
 dentadas



gerade
 straight
 rette
 rectas

gebogen
 curved
 curve
 curvas

GORNEY

HA 660S23

230mm / 9"

HA 661S23



FREEMANN

HA 663S18

180mm / 7"



HA 665S17

170mm / 6 3/4"



gerade
 straight
 rette
 rectas

gebogen
 curved
 curve
 curvas

FREEMANN - KAYE

HA 670S18

180mm / 7"

HA 671S18



gerade
 straight
 rette
 rectas

gebogen
 curved
 curve
 curvas

FREEMANN - GORNEY

HA 672S19

190mm / 7 1/2"

HA 673S19

gezahnt
 saw edge
 dentellate
 dentadas

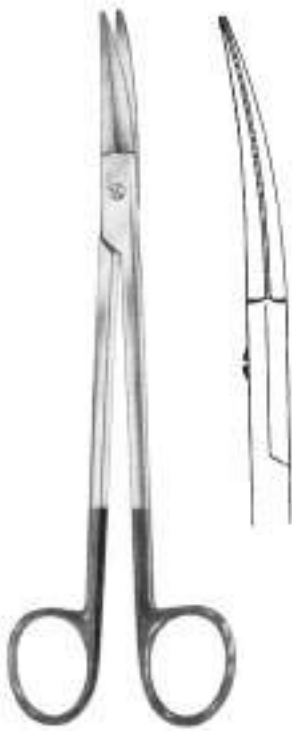

KAYE

HA 675S15 150mm / 6"
HA 675S19 190mm / 7½"



HA 676S11 110mm / 4½"



HA 676S14 140mm / 5½"



CASTANARES

HA 677S16 160mm / 6½"



gerade
 straight
 rette
 rectas



GORNEY

HA 678S19 190mm / 7½"



gebogen
 curved
 curve
 curvas

HA 679S19



LISTER

HA 835S14 140mm / 5½"
HA 835S18 180mm / 7"
HA 835S20 200mm / 8"



CT - ORO

C = carbide T = tungsten

C = carburo T = tungsteno

Tungsten oder Wolfram ist ein metallisches Element, welches im Jahre 1783 durch den schwedischen Chemiker Karl Wilhelm Scheele entdeckt wurde.

Elementsymbol = W, Ordnungszahl = 74, Atomgewicht = 183,86, Schmelzpunkt liegt bei ca. 3380°C, also höher als bei allen anderen bekannten Metallen, der Siedepunkt liegt bei 5500°C.

In Legierung mit metallischen Carbiden liegt die Härte annähernd beim Diamanten.

Tungsten Carbide ist das härteste von menschenhand geschaffene Metall.

Tungston or Wolfram is a metal element that was discovered in 1783 by the Swedish chemist Karl Wilhelm Scheele.

Element symbol = W, Ident. Number = 74, Atom weight = 183,86. Melting point is approx. 3380°C, (higher than all other know metals), boiling point is 5500°C.

When combined as an alloy with metal carbides, it achieves nearly diamond hardness.

Tungsten Carbide is the hardes man-made material.

Tungsteno o Wolfram é un elemento metallico, che fu scoperto nell'anno 1783 dal Chimico svedese Karl Wilhelm Scheele.

Simbolo d'elemento = W, numero ordinale = 74, peso atomico = 183,86, il punto di fusione si trova a ca. 3380°C, quindi piú alto di tutti gli altri metalli conosciuti, il punto d'ebolizione si trova a 5500°C.

Il tungsteno in lega con il carburo raggiunge un grado di durezza vicino a quello del diamante.

Carburo di tungsteno é la lega di metallo piú dura fino ad ora sviluppata da mani umane.

Tungsteno o Wolfram es un elemento metálico, que fue descubierto en el ano 1783 por el químico sueco Karl Wilhelm Scheele.

Símbolo del elemento = W, número ordinal = 74, peso atómico 183,86, el punto de fusión es aproximádamente de 3380°C, es decir mas alto que él de todos los metales conocidos, el punto de ebullición es aproximádamente 5500°C.

En aleación con carburos metálicos la dureza es parecida a la del diamante.

Carburo de tungsteno es el metal más duro creado por el hombre.

CT - ORO



STANDARD
AA 902.14 - AA 906.14
140mm / 5½"



AA 902.14



AA 904.14



AA 906.14



STANDARD
AA 903.14 - AA 907.14
140mm / 5½"



AA 903.14



AA 905.14



AA 907.14

CT - ORO



MAYO
AA 910.14 - AA 910.23



AA 910.14
140mm / 5½"



AA 910.17
170mm / 6¾"



AA 910.23
230mm / 9"



MAYO
AA 911.14 - AA 911.23



AA 911.14
140mm / 5½"



AA 911.17
170mm / 6¾"



AA 911.23
230mm / 9"

CT - ORO

Nahtscheren
Suture Scissors
Forbici per sutura
Tijeras para sutura



AA 913.14 - AA 913.23



AA 913.14
140mm / 5½"



AA 913.17
170mm / 6¾"



AA 913.23
230mm / 9"



CT - ORO

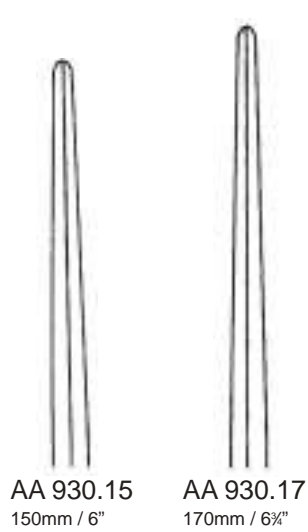
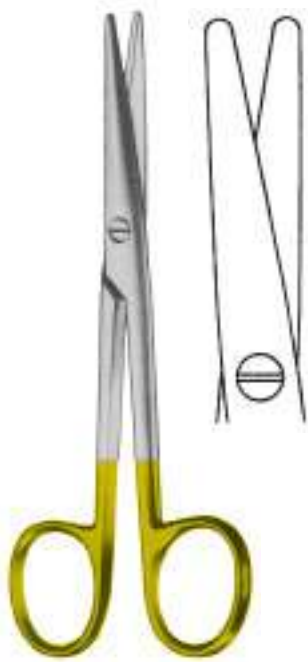

MAYO - STILLE
 AA 930.15 - AA 930.17

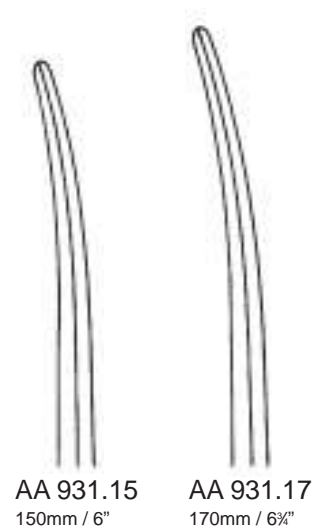

MAYO - STILLE
 AA 931.15 - AA 931.17



MAYO - LEXER
 AA 935.16
 160mm / 6 $\frac{1}{2}$ "



METZENBAUM
 AA 936.11 - AA 939.14

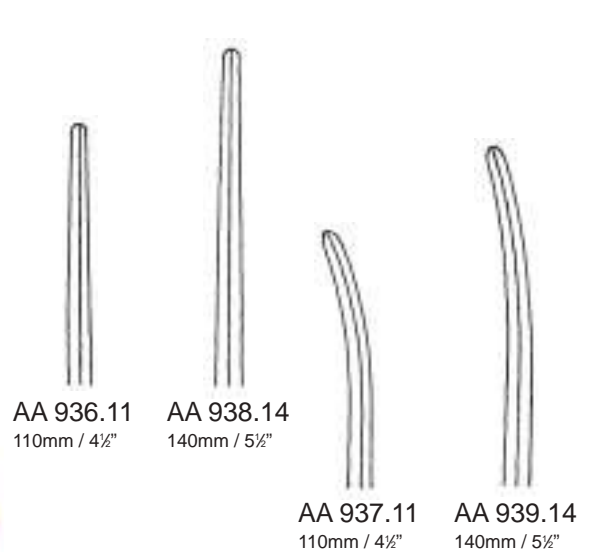

CT - ORO



METZENBAUM
AA 942.18 - AA 942.30

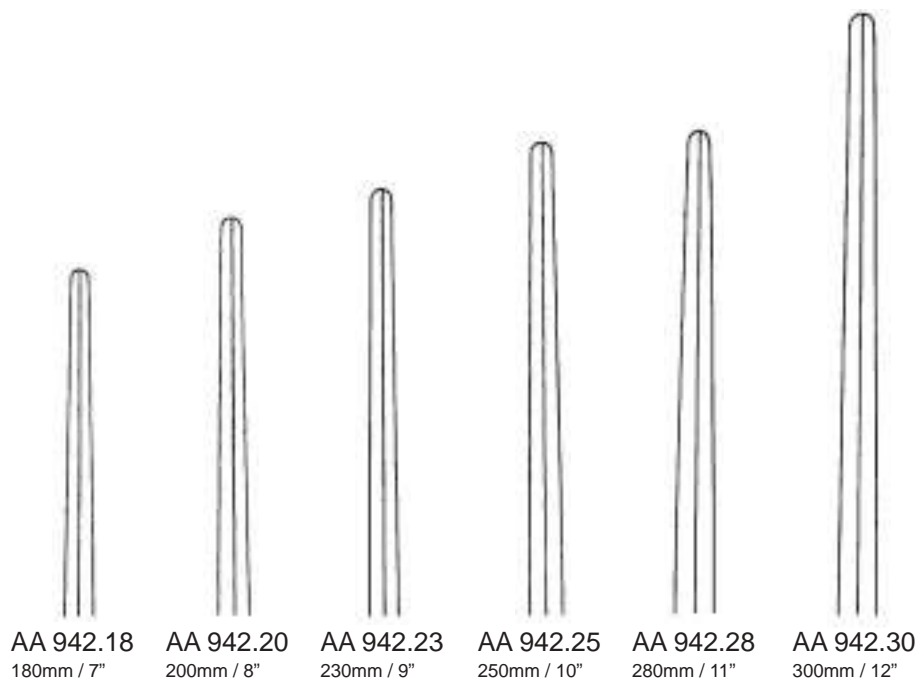

METZENBAUM
AA 943.18 - AA 943.30

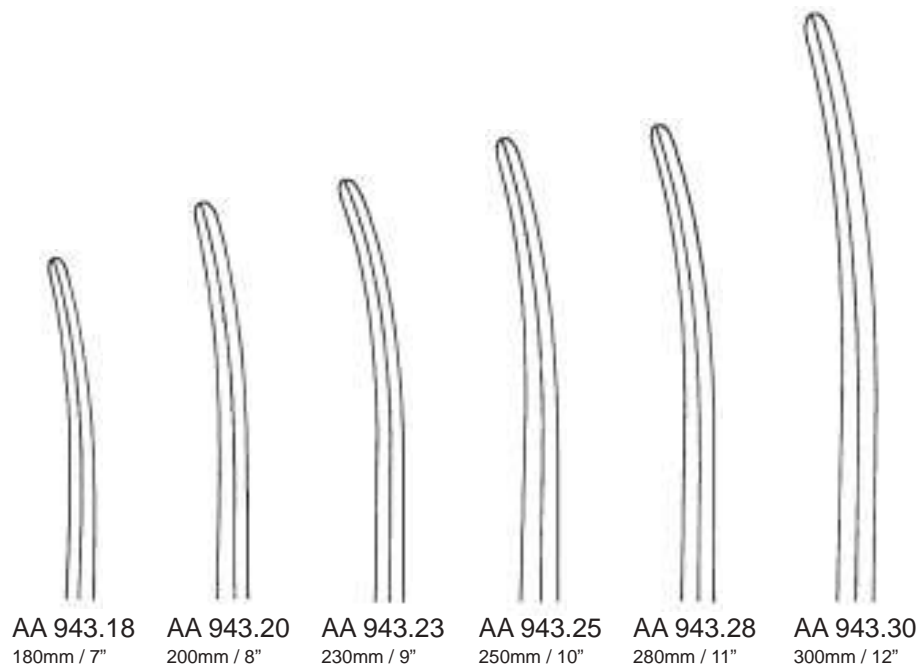

CT - ORO



METZENBAUM - THOREK
AA 945.20 - AA 945.28



AA 945.20
200mm / 8"



AA 945.23
230mm / 9"



AA 945.28
280mm / 11"



METZENBAUM - S
AA 949.20 - AA 949.28



AA 949.20
200mm / 8"

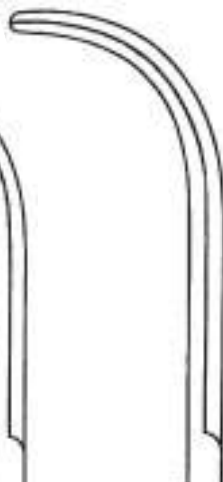

AA 949.23
230mm / 9"

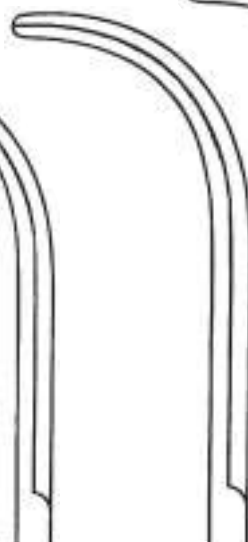

AA 949.25
250mm / 10"

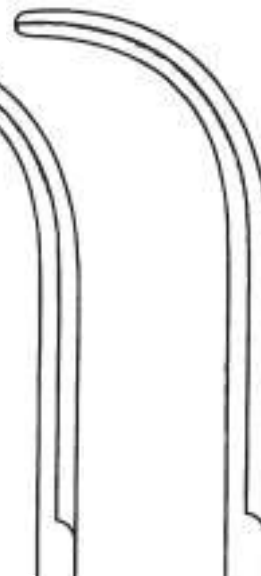

AA 949.28
280mm / 11"

CT - ORO



AA 950.16
160mm / 6½"

AA 950.21
210mm / 8"

LEXER
AA 950.16 - AA 950.21



AA 951.16
160mm / 6½"

AA 951.21
210mm / 8"

LEXER
AA 951.16 - AA 951.21



MAYO - LEXER
AA 952.16
160mm / 6½"

CT - ORO



METZENBAUM - FINO
AA 954.14 - AA 955.14
 140mm / 5½"

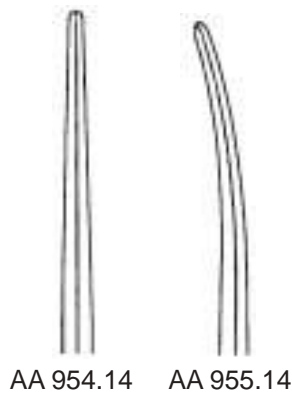

AA 954.14 AA 955.14

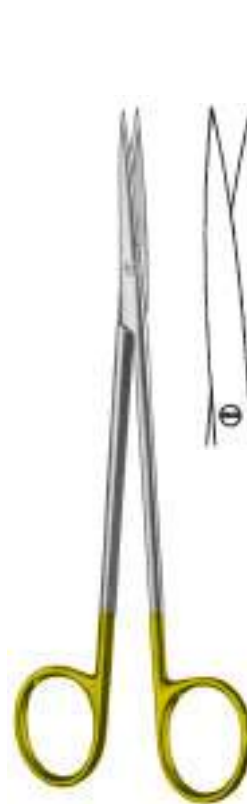

METZENBAUM - FINO
AA 956.14 - AA 956.23

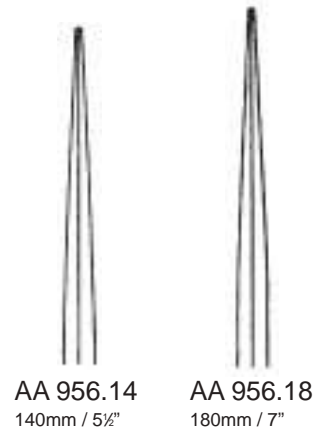

AA 956.14 AA 956.18
 140mm / 5½" 180mm / 7"



METZENBAUM - FINO
AA 957.14 - AA 957.23

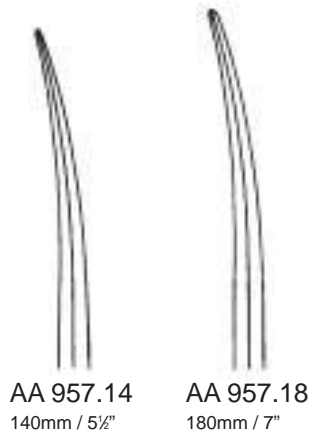

AA 957.14 AA 957.18
 140mm / 5½" 180mm / 7"



AA 957.20 AA 957.23
 200mm / 8" 230mm / 9"

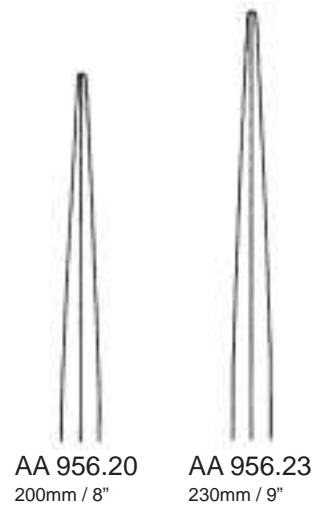

AA 956.20 AA 956.23
 200mm / 8" 230mm / 9"

CT - ORO



METZENBAUM - FINO
AA 960.18 - AA 960.28

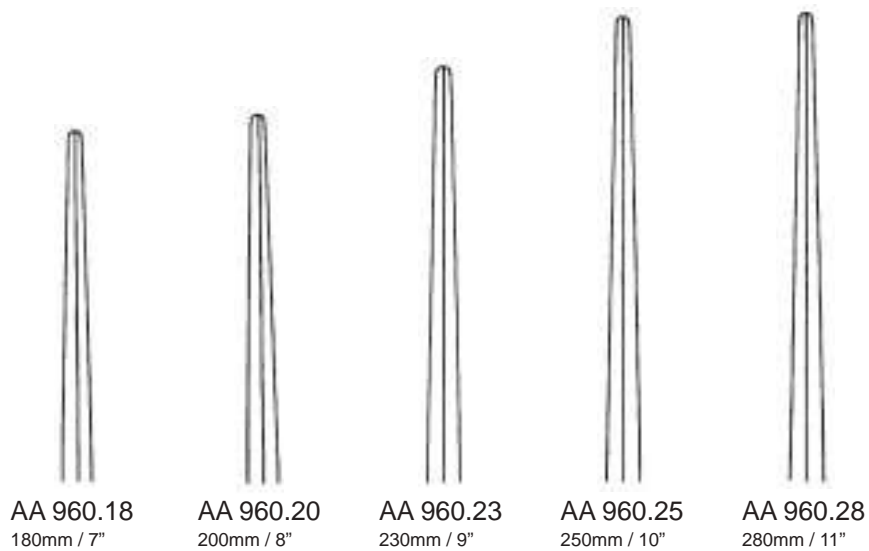

METZENBAUM - FINO
AA 961.18 - AA 961.28

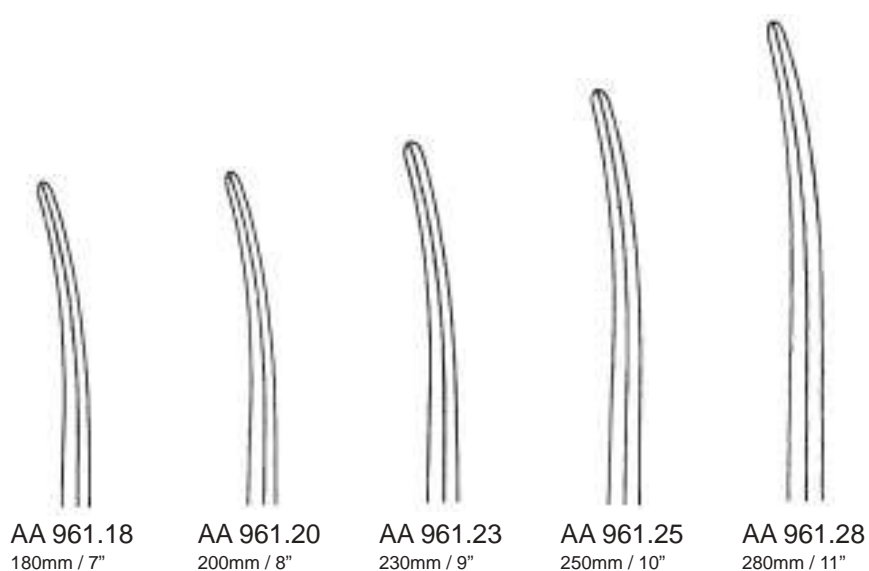

CT - ORO



METZENBAUM - LAHEY
AA 965.14
140mm / 5½"



TOENNIS - ADSON
AA 965.17
170mm / 6¾"



METZENBAUM
AA 965.20 - AA 965.23



AA 965.20
200mm / 8"



AA 965.23
230mm / 9"

CT - ORO



METZENBAUM - FINO
AA 967.18 - AA 967.23

S-förmig gebogen
S-shaped
 curve in S
curvas en S



AA 967.18
 180mm / 7"



AA 967.20
 200mm / 8"



AA 967.23
 230mm / 9"



METZENBAUM - FINO
AA 969.18 - AA 969.23

S-förmig gebogen
S-shaped
 curve in S
curvas en S



AA 969.18
 180mm / 7"



AA 969.20
 200mm / 8"



AA 969.23
 230mm / 9"

CT - ORO



MAYO - HARRINGTON
AA 975.28
280mm / 11"

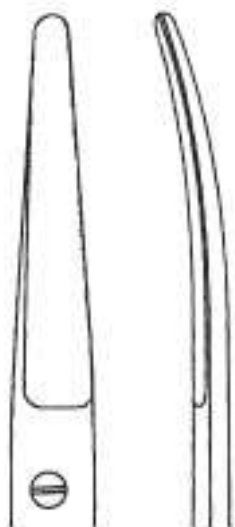

SIMS
AA 976.23 - AA 977.23
230mm / 9"

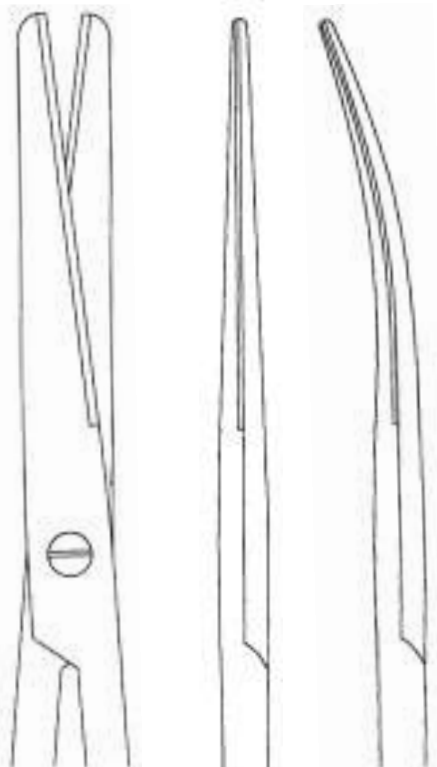

AA 976.23 AA 977.23



PARAMETRIUM
AA 979.22 - AA 979.23



AA 979.22
220mm / 8 3/4"



AA 979.23
230mm / 9"

CT - ORO

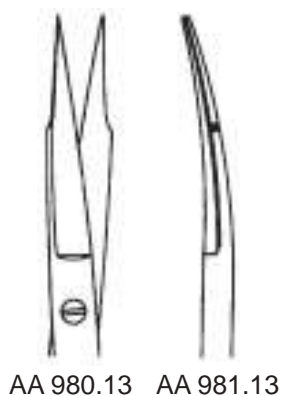
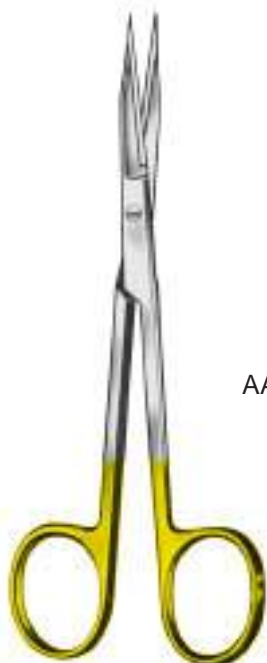

AA 980.13 AA 981.13

GOLDMANN - FOX
 AA 980.13 - AA 981.13
 130mm / 5"

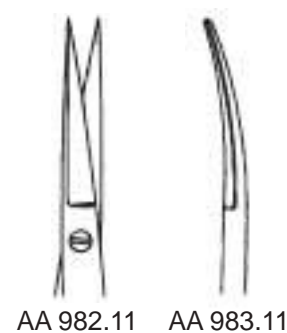
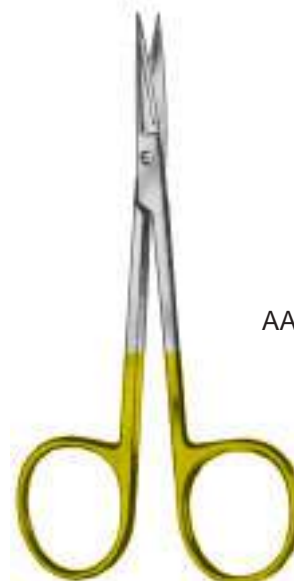

AA 982.11 AA 983.11

AA 982.11 - AA 983.11
 110mm / 4 1/2"

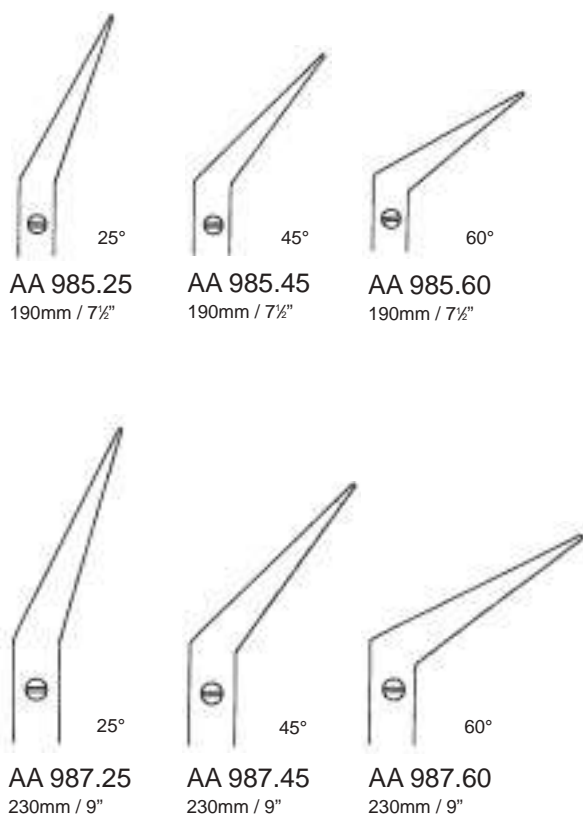
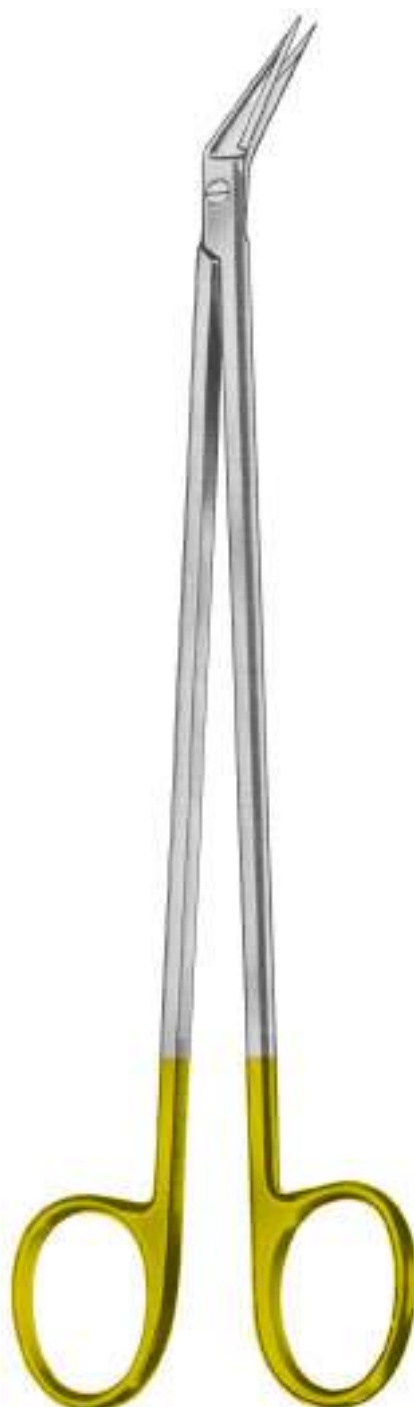

AA 985.25
 190mm / 7 1/2"

AA 985.45
 190mm / 7 1/2"

AA 985.60
 190mm / 7 1/2"

AA 987.25
 230mm / 9"

AA 987.45
 230mm / 9"

AA 987.60
 230mm / 9"

DE BAKEY (POTTS - SMITH)
 AA 985.25 - AA 987.60

CT - ORO



AA 989.11
 110mm / 4 1/2"



RAGNELL (KILLNER)
AA 991.12
 120mm / 4 3/4"

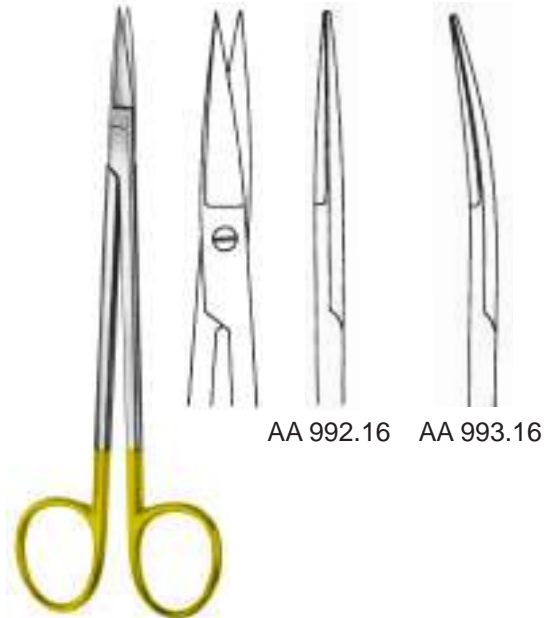

KELLY
AA 992.16 - AA 993.16
 160mm / 6 1/2"

1 Schneide gezahnt
 1 blade saw edge
 1 lama dentellata
 1 hoja dentada



DEAN
AA 994.17
 170mm / 6 3/4"



UNIVERSAL
AA 995.12
 120mm / 4 3/4"

1 Schneide gezahnt
 1 blade saw edge
 1 lama dentellata
 1 hoja dentada



LOCKLIN
AA 997.16
 160mm / 6 1/2"

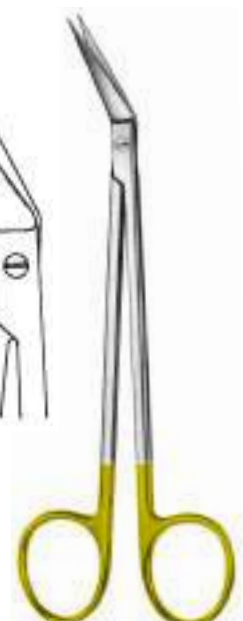

LOCKLIN
AA 999.16
 160mm / 6 1/2"



PINZETTEN
FORCEPS
PINZE
PINZAS



HUNT
AB 001.01
 200mm / 8"



YASARGIL
AB 001.03 - AB 001.05
 220mm / 8 3/4"



AB 001.03
 Ø 3mm



AB 001.05
 Ø 5mm



YASARGIL
AB 003.03 - AB 003.05
 220mm / 8 3/4"



AB 003.03
 Ø 3mm



AB 003.05
 Ø 5mm



YASARGIL
AB 005.03 - AB 005.05
 220mm / 8 3/4"



AB 005.03
 Ø 3mm



AB 005.05
 Ø 5mm



GOMEL
AB 006.01
160mm / 6½"



GOMEL
AB 006.02
160mm / 6½"



AB 016.16
160mm / 6½"

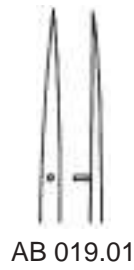

AB 019.01



AB 019.02



AB 019.03

AB 019.01 - AB 019.03
185mm / 7 1/4"









AB 020.01



AB 020.02

AB 020.01 - AB 020.02
230mm / 9"



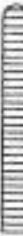







			
AB 100.11 110mm / 4½"	AB 100.13 130mm / 5"	AB 100.14 140mm / 5½"	AB 100.16 160mm / 6½"
			
AB 100.18 180mm / 7"	AB 100.20 200mm / 8"	AB 100.25 250mm / 10"	AB 100.30 300mm / 12"

STANDARD
AB 100.11 - AB 100.30

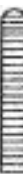
Schmal
 Narrow
 Strette
 Estrechas



				
AB 120.10 100mm / 4¼"	AB 120.11 110mm / 4½"	AB 120.13 130mm / 5"	AB 120.14 140mm / 5½"	AB 120.16 160mm / 6½"
				
AB 120.18 180mm / 7"	AB 120.20 200mm / 8"	AB 120.25 250mm / 10"	AB 120.30 300mm / 12"	

STANDARD
AB 120.10 - AB 120.30



STANDARD

- AB 105.10** // 100mm / 4 $\frac{1}{4}$ "
- AB 105.11** // 110mm / 4 $\frac{1}{2}$ "
- AB 105.13** // 130mm / 5"
- AB 105.14** // 140mm / 5 $\frac{1}{2}$ "
- AB 105.15** // 150mm / 6"
- AB 105.16** // 160mm / 6 $\frac{1}{2}$ "
- AB 105.18** // 180mm / 7"
- AB 105.20** // 200mm / 8"
- AB 105.25** // 250mm / 10"
- AB 105.30** // 300mm / 12"



AB 126.13 - AB 126.14

AB 126.13
130mm / 5"

AB 126.14
140mm / 5 $\frac{1}{2}$ "



STILLE

AB 130.15 - AB 130.20

AB 130.15
150mm / 6"

AB 130.18
180mm / 7"

AB 130.20
200mm / 8"



AB 140.09 - AB 141.14



AB 140.09
90mm / 3 $\frac{1}{2}$ "



AB 140.10
100mm / 4"



AB 140.11
110mm / 4 $\frac{1}{2}$ "



AB 140.13
130mm / 5"



AB 140.14
140mm / 5 $\frac{1}{2}$ "



AB 141.09
90mm / 3 $\frac{1}{2}$ "



AB 141.10
100mm / 4"



AB 141.11
110mm / 4 $\frac{1}{2}$ "



AB 141.13
130mm / 5"



AB 141.14
140mm / 5 $\frac{1}{2}$ "



MINI - ADSON
AB 166.12
 120mm / 4¾"



ADSON
AB 168.12 - AB 168.15



AB 168.12
 120mm / 4¾"



AB 168.15
 150mm / 6"



MC INDOE
AB 170.15
 150mm / 6"



SEMKEN
AB 172.12 - AB 172.15

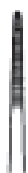

AB 172.12
 120mm / 4¾"



AB 172.15
 150mm / 6"



AB 176.18
 180mm / 7"



TAYLOR
AB 178.17
 170mm / 6¾"



TAYLOR
AB 180.17
 170mm / 6¾"



TAYLOR
AB 183.17
 170mm / 6¾"

Anatomische Pinzetten
Dressing Forceps
Pinze anatomiche per dissezione
Pinzas de disección

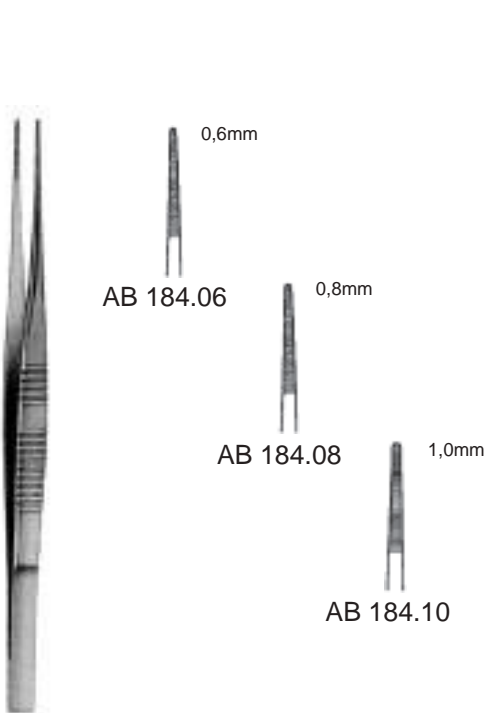

AB 184.06 - AB 184.10
 150mm / 6"



GERALD
AB 186.18 - AB 187.18
 180mm / 7"



CUSHING
AB 188.17 - AB 189.17
 170mm / 6 3/4"



WAUGH
AB 190.15 // 150mm / 6"
AB 190.18 // 180mm / 7"
AB 190.20 // 200mm / 8"



POTTS - SMITH
AB 192.18 - AB 192.25



AB 192.18
 180mm / 7"



AB 192.21
 210mm / 8 1/4"



AB 192.25
 250mm / 10"



AB 196.16
 160mm / 6 1/2"



WANGENSTEEN
AB 220.23
 230mm / 9"

CT - ORO

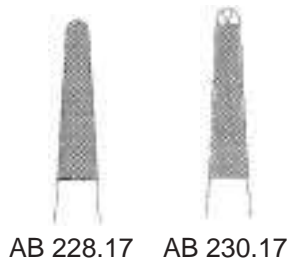

Normalprofil
 Normal profile
 Profilo normale
 Perfil normal

BONNEY
 AB 228.17 - AB 230.17
 170mm / 6 3/4"



GERALD
 AB 232.17 - AB 234.17
 170mm / 6 3/4"



GILLIES
 AB 236.15
 150mm / 6"



Miniprofil
 Mini profile
 Profilo mini
 Perfil mini

MCINDOE
 AB 238.15
 150mm / 6"



AB 240.16 AB 240.18
 160mm / 6 1/2" 180mm / 7"

Normalprofil
 Normal profile
 Profilo normale
 Perfil normal

AB 242.16 AB 242.18
 160mm / 6 1/2" 180mm / 7"

Miniprofil
 Mini profile
 Profilo mini
 Perfil mini

SEMKEN
 AB 240.16 - AB 242.18

CT - ORO



Normalprofil
Normal profile
 Profilo normale
 Perfil normal

ADSON - BROWN
AB 244.12
 120mm / 4 $\frac{1}{4}$ "

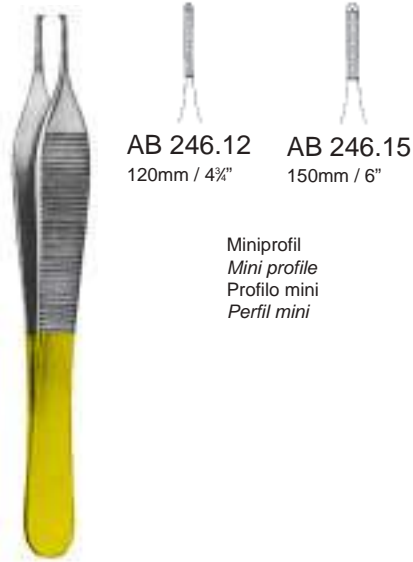

AB 246.12 **AB 246.15**
 120mm / 4 $\frac{1}{4}$ " 150mm / 6"

Miniprofil
Mini profile
 Profilo mini
 Perfil mini

MICRO - ADSON
AB 246.12 - AB 246.15

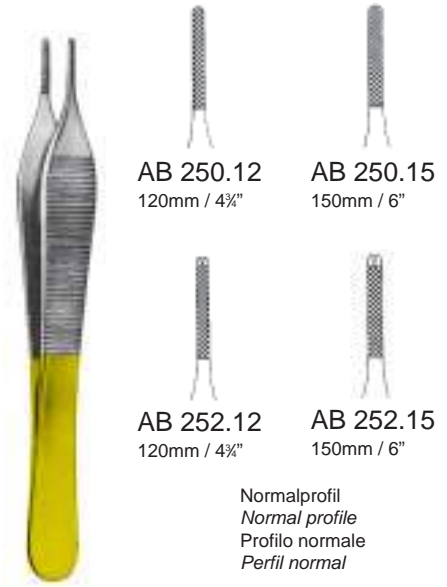

AB 250.12 **AB 250.15**
 120mm / 4 $\frac{1}{4}$ " 150mm / 6"

AB 252.12 **AB 252.15**
 120mm / 4 $\frac{1}{4}$ " 150mm / 6"

Normalprofil
Normal profile
 Profilo normale
 Perfil normal

ADSON
AB 250.12 - AB 252.15

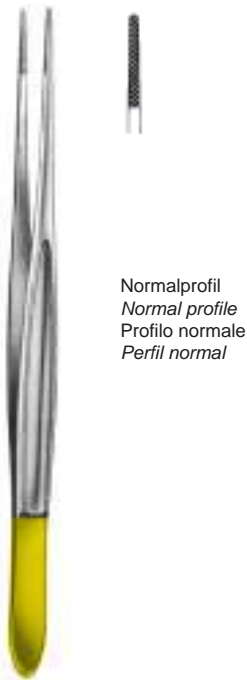

Normalprofil
Normal profile
 Profilo normale
 Perfil normal

CUSHING
AB 254.17
 170mm / 6 $\frac{3}{4}$ "

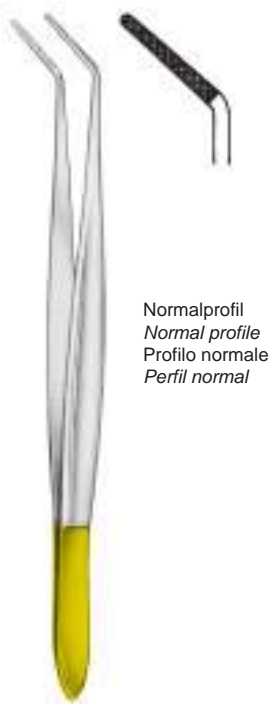

Normalprofil
Normal profile
 Profilo normale
 Perfil normal

CUSHING
AB 255.18
 180mm / 7"

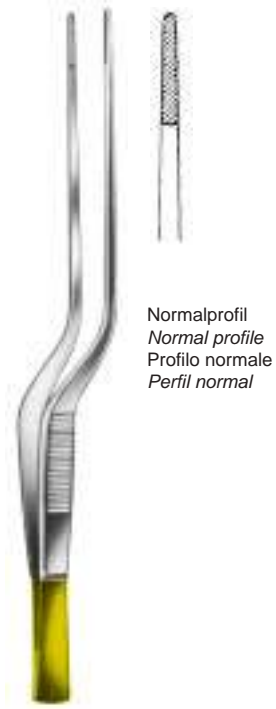

Normalprofil
Normal profile
 Profilo normale
 Perfil normal

CUSHING - TAYLOR
AB 256.18
 180mm / 7"

CT - ORO



AB 258.15
150mm / 6"



AB 258.18
180mm / 7"



AB 258.20
200mm / 8"



AB 258.23
230mm / 9"



AB 258.25
250mm / 10"



Normalprofil, *Normal profile*
Profilo normale, *Perfil normal*



POTTS - SMITH
AB 258.15 - AB 258.25

GRUENWALD
AB 259.19
190mm / 7½"



AB 260.14
140mm / 5½"



AB 260.16
160mm / 6½"



AB 260.18
180mm / 7"



AB 260.20
200mm / 8"



AB 260.25
250mm / 10"



AB 260.30
300mm / 12"



Normalprofil, *Normal profile*
Profilo normale, *Perfil normal*

OEHLER
AB 260.14 - AB 260.30

CT - ORO



WANGENSTEEN
AB 266.15 - AB 266.25

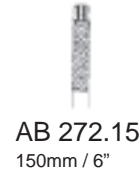
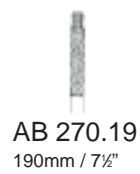

Mikroprofil
Micro profile
Profilo micro
Perfil micro

Miniprofil
Mini profile
Profilo mini
Perfil mini

DE BAKEY
AB 270.15 - AB 272.24



AB 103.10
 100mm / 4"

AB 103.11
 110mm / 4½"

AB 103.13
 130mm / 5"

AB 103.14
 140mm / 5½"

AB 103.16
 160mm / 6"



AB 103.18
 180mm / 7"



AB 103.20
 200mm / 8"



AB 103.25
 250mm / 10"



AB 103.30
 300mm / 12"

STANDARD
AB 103.10 - AB 103.30
 1:2 Zähne, Teeth, Denti, Dientes



AB 123.11
 110mm / 4½"

AB 123.13
 130mm / 5"

AB 123.14
 140mm / 5½"

AB 123.16
 160mm / 6"



AB 123.18
 180mm / 7"



AB 123.20
 200mm / 8"



AB 123.25
 250mm / 10"

STANDARD
AB 123.11 - AB 123.25
 2:3 Zähne, Teeth, Denti, Dientes

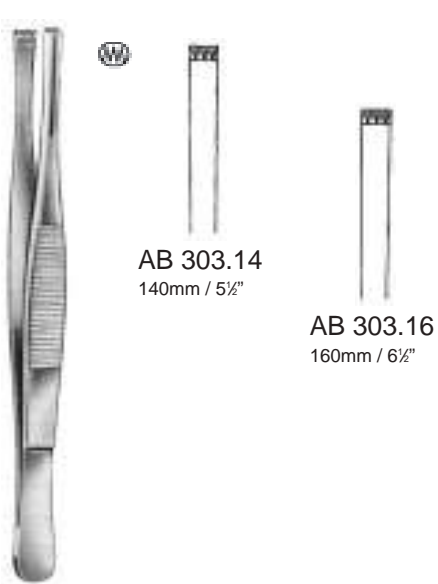

AB 303.14
 140mm / 5½"

AB 303.16
 160mm / 6½"

AB 303.14 - AB 303.16
 3:4 Zähne, *Teeth, Denti, Dientes*

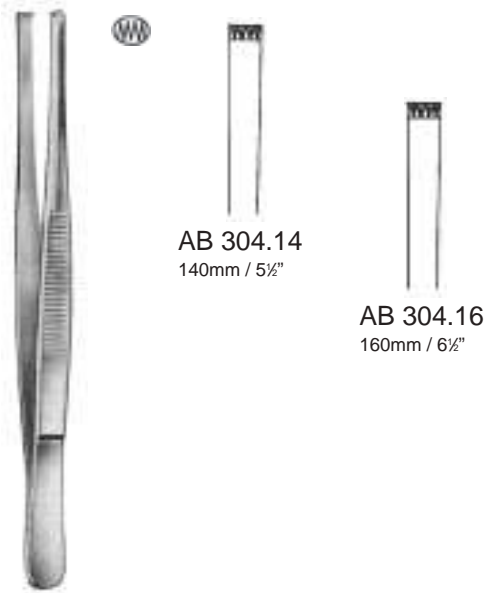

AB 304.14
 140mm / 5½"

AB 304.16
 160mm / 6½"

AB 304.14 - AB 304.16
 4:5 Zähne, *Teeth, Denti, Dientes*

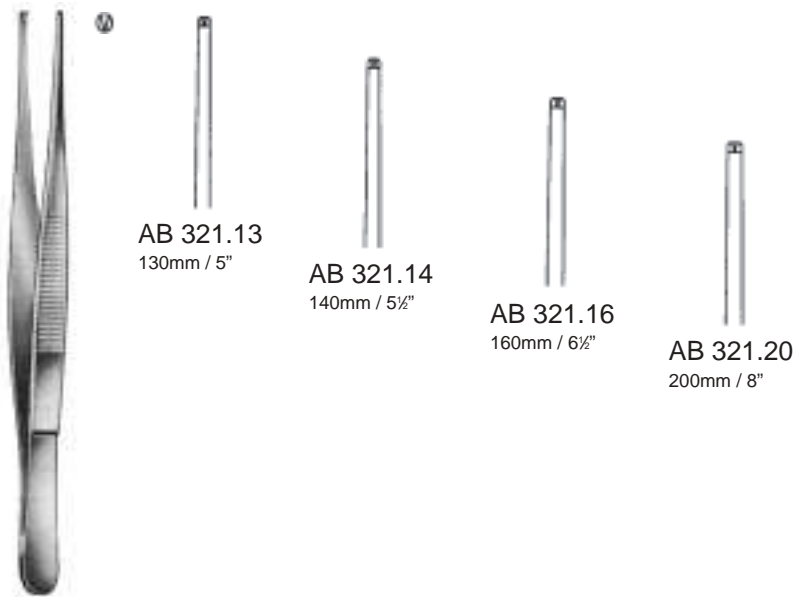

AB 321.13
 130mm / 5"

AB 321.14
 140mm / 5½"

AB 321.16
 160mm / 6½"

AB 321.20
 200mm / 8"

AB 321.13 - AB 321.20
 1:2 Zähne, *Teeth, Denti, Dientes*

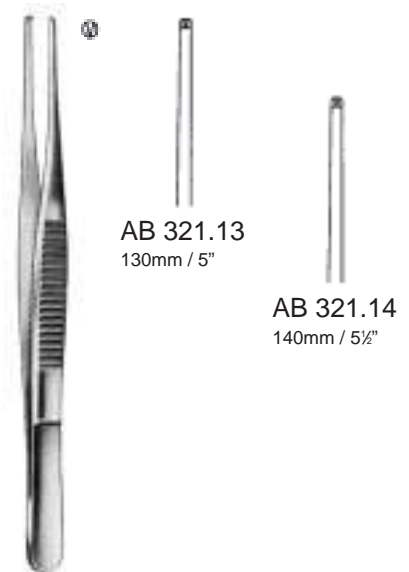

AB 321.13
 130mm / 5"

AB 321.14
 140mm / 5½"

AB 326.13 - AB 326.14
 1:2 Zähne, *Teeth, Denti, Dientes*



STILLE
AB 331.15
 150mm / 6"
 1:2 Zähne, Teeth, Denti, Dientes



STILLE
AB 332.15
 150mm / 6"
 2:3 Zähne, Teeth, Denti, Dientes



STILLE - BARRAYA
AB 362.18 - AB 362.25



AB 362.18
 180mm / 7"

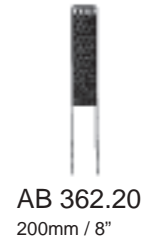

AB 362.20
 200mm / 8"



AB 362.25
 250mm / 10"

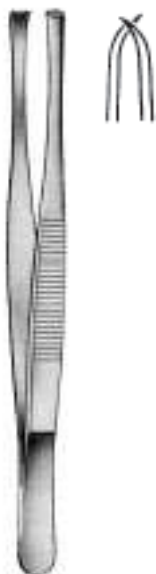

STONE
AB 364.15
 150mm / 6"
 4:5 Zähne, Teeth, Denti, Dientes



LERCHE
AB 365.15
 150mm / 6"
 5:6 Zähne, Teeth, Denti, Dientes



ADLERKREUTZ
AB 366.15 - AB 367.25



AB 366.15
 150mm / 6"



AB 366.20
 200mm / 8"

2:3 Zähne
 Teeth
 Denti
 Dientes

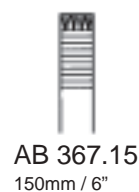

AB 367.15
 150mm / 6"

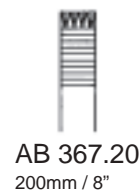

AB 367.20
 200mm / 8"

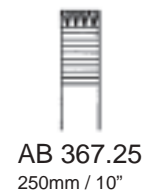

AB 367.25
 250mm / 10"

4:5 Zähne
 Teeth
 Denti
 Dientes



AB 368.12
 120mm / 4 3/4"

AB 368.15
 150mm / 6"

ADSON
AB 368.12 - AB 368.15
 1:2 Zähne, *Teeth, Denti, Dientes*



GILLIES
AB 370.15
 150mm / 6"
 1:2 Zähne, *Teeth, Denti, Dientes*



AB 372.12
 120mm / 4 3/4"

AB 372.15
 150mm / 6"

SEMKEN
AB 372.12 - AB 372.15
 1:2 Zähne, *Teeth, Denti, Dientes*



TAYLOR
AB 374.17
 170mm / 6 3/4"
 1:2 Zähne, *Teeth, Denti, Dientes*



TAYLOR
AB 380.17
 170mm / 6 3/4"
 1:2 Zähne, *Teeth, Denti, Dientes*



TAYLOR
AB 383.17
 170mm / 6 3/4"
 1:2 Zähne, *Teeth, Denti, Dientes*



AB 384.06
 0,6mm

AB 384.08
 0,8mm

AB 384.10
 1,0mm

AB 384.06 - AB 384.10
 150mm / 6"
 1:2 Zähne, *Teeth, Denti, Dientes*



GERALD
AB 386.17 - AB 387.17
 170mm / 6 $\frac{3}{4}$ "
 1:2 Zähne, *Teeth*, *Denti*, *Dientes*



CUSHING
AB 388.17
 170mm / 6 $\frac{3}{4}$ "
 1:2 Zähne, *Teeth*, *Denti*, *Dientes*



WAUGH
AB 390.15 - AB 390.20
 1:2 Zähne, *Teeth*, *Denti*, *Dientes*

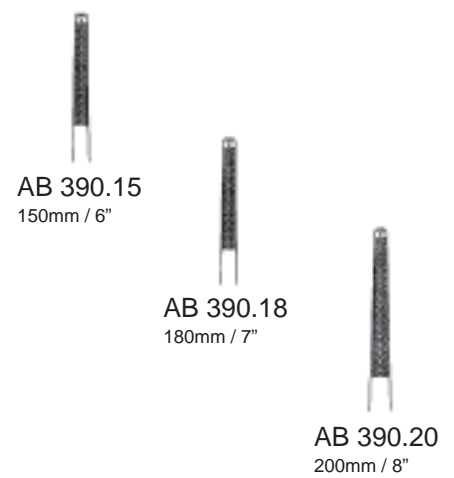

POTTS - SMITH
AB 392.18 - AB 392.25
 1:2 Zähne, *Teeth*, *Denti*, *Dientes*

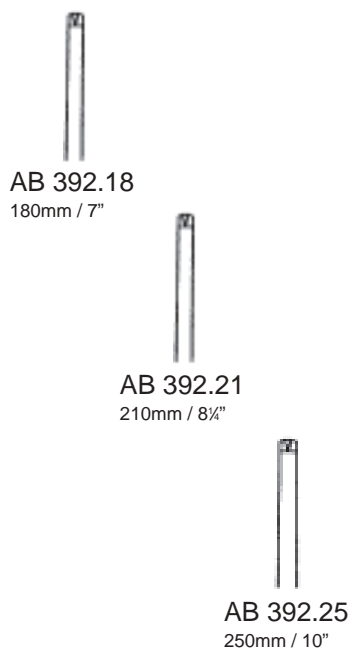

BROPHY
AB 396.20
 200mm / 8"
 1:2 Zähne, *Teeth*, *Denti*, *Dientes*



ADSON - BROWN
AB 400.12
120mm / 4¾"



MINI - ADSON
AB 402.12
120mm / 4¾"
1:2 Zähne, *Teeth*, *Denti*, *Dientes*



MINI - ADSON
AB 403.12
120mm / 4¾"
1:2 Zähne, *Teeth*, *Denti*, *Dientes*



MICRO - ADSON
AB 404.12
120mm / 4¾"
1:2 Zähne, *Teeth*, *Denti*, *Dientes*



MICRO - ADSON
AB 406.12
120mm / 4¾"
1:2 Zähne, *Teeth*, *Denti*, *Dientes*



AB 408.11
110mm / 4½"

Extrem feine Zähne
Teeth extremely delicate
Denti finissimi
Dientes muy finos



AB 410.01
120mm / 4¾"



AB 410.02
110mm / 4½"



AB 410.03
110mm / 4½"



AB 410.04
120mm / 4¾"



RUSS. MODELL
AB 420.15 - AB 420.25



AB 420.15
150mm / 6"



AB 420.20
200mm / 8"



AB 420.25
250mm / 10"

FRANCESCO DURANTE, * 1845

Gründer der Zeitschrift "Il Policlinico"
 Founder from the review "Il Policlinico"
 Fondatore della rivista "Il Policlinico"
 Fundador de la revista "Il Policlinico"



DURANTE
AB 426.14 - AB 426.25



AB 426.14
140mm / 5½"



AB 426.16
160mm / 6½"



AB 426.20
200mm / 8"



AB 426.25
250mm / 10"



AB 431.18
 1:2 Zähne
 Teeth
 Denti
 Dientes



AB 432.18
 2:3 Zähne
 Teeth
 Denti
 Dientes



FERRIS - SMITH
AB 431.18 - AB 432.18
 180mm / 7"



AB 448.15
 150mm / 6"



AB 448.18
 180mm / 7"



1:2 Zähne
 Teeth
 Denti
 Dientes

AB 449.15
 150mm / 6"



2:3 Zähne
 Teeth
 Denti
 Dientes

LANE
AB 448.15 - AA 449.15



AB 451.18
 1:2 Zähne
 Teeth
 Denti
 Dientes



AB 452.18
 2:3 Zähne
 Teeth
 Denti
 Dientes



BONNEY
AB 451.18 - AB 452.18
 180mm / 7"



MAYO - RUSS.
AB 456.23
 230mm / 9"



SINGLE - TUTTLE
AB 460.23
 230mm / 9"



NELSON
AB 466.23
 230mm / 9"



1:2 Zähne, *Teeth, Denti, Dientes*

AB 502.10 - AB 515.10
 105mm / 4¹/₄"



AB 600.09 // 90mm / 3¹/₂"
AB 600.10 // 100mm / 4¹/₄"
AB 600.11 // 110mm / 4¹/₂"
AB 600.12 // 120mm / 4³/₄"



AB 601.09 // 90mm / 3¹/₂"
AB 601.10 // 100mm / 4¹/₄"
AB 601.11 // 110mm / 4¹/₂"
AB 601.12 // 120mm / 4³/₄"



AB 604.08 // 80mm / 3¹/₂"
AB 604.09 // 90mm / 3¹/₂"
AB 604.10 // 100mm / 4¹/₄"
AB 604.11 // 110mm / 4¹/₂"
AB 604.12 // 120mm / 4³/₄"



AB 605.08 // 80mm / 3¹/₂"
AB 605.09 // 90mm / 3¹/₂"
AB 605.10 // 100mm / 4¹/₄"
AB 605.11 // 110mm / 4¹/₂"
AB 605.12 // 120mm / 4³/₄"



AB 522.12
120mm / 4¾"



FEILCHENFELD
AB 530.07 - AB 530.11



AB 530.07
70mm / 2¾"



AB 530.09
90mm / 3½"



AB 530.11
110mm / 4½"



HUNTER
AB 540.10 - AB 541.10
100mm / 4¾"



AB 540.10



AB 541.10



WALTER - CARMALT
AB 550.10 - AB 551.10
100mm / 4¾"



AB 550.10



AB 551.10



AB 557.10
100mm / 4¾"



AB 559.10
100mm / 4¾"



SHAAF
AB 561.09
90mm / 3½"



LITTAUER
AB 564.08
80mm / 3¼"



AB 566.09
 90mm / 3½"



DOUGLAS
AB 574.09 - AB 576.09
 90mm / 3½"



AB 574.09



AB 576.09



BEER
AB 580.09
 90mm / 3½"



BARRAQUER
AB 595.10
 100mm / 4¼"



STIEGLITZ
AB 720.13 - AB 721.13
 130mm / 5"



AB 720.13



AB 721.13



TROELTSCH - WILDE
AB 671.11
110mm / 4½"



TROELTSCH - WILDE
AB 675.12
120mm / 4¾"



TROELTSCH - WILDE
AB 681.13
130mm / 5"



TROELTSCH
AB 685.15
150mm / 6"



TROELTSCH
AB 687.18
180mm / 7"



LUCAE
AB 691.14
140mm / 5½"



JANSEN
AB 695.16 // 160mm / 6½"
AB 695.20 // 200mm / 8"



GRUENWALD - JANSEN
AB 697.20
200mm / 8"



ARTERIENKLEMMEN
ARTERY FORCEPS
PINZE EMOSTATICHE
PINZAS HEMOSTÀTICAS



DIEFFENBACH
AC 110.06
 60mm / 2¼"



DIEFFENBACH
AC 111.06
 60mm / 2¼"



AC 114.03
 35mm / 1½"

DIEFFENBACH
AC 114.03 - AC 114.05



AC 114.05
 50mm / 2"



AC 115.03
 35mm / 1½"

DIEFFENBACH
AC 115.03 - AC 115.05



AC 115.05
 50mm / 2"



AC 118.04
 40mm / 1¾"

JOHNS - HOPKINS
AC 118.04 - AC 118.09



AC 118.05
 50mm / 2"



AC 118.06
 65mm / 2½"



AC 118.07
 75mm / 3"



AC 118.09
 90mm / 3½"



AC 119.04
 40mm / 1¾"

JOHNS - HOPKINS
AC 119.04 - AC 119.09



AC 119.05
 50mm / 2"



AC 119.06
 65mm / 2½"



AC 119.07
 75mm / 3"



AC 119.09
 90mm / 3½"

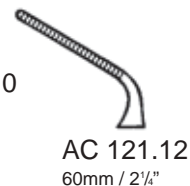
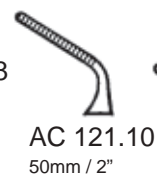

DIETRICH
AC 120.08 - AC 121.12

DE BAKEY - DIETRICH
AC 122.10 - AC 123.20

ATRAUMATIC



	Länge <i>Length</i> Lunghezza <i>Largo</i>	Maul <i>Jaws</i> Morso <i>Boca</i>		Länge <i>Length</i> Lunghezza <i>Largo</i>	Maul <i>Jaws</i> Morso <i>Boca</i>
AC 120.08	50mm	8mm	AC 122.10	50mm	10mm
AC 120.10	50mm	12mm	AC 122.14	50mm	14mm
AC 120.12	60mm	20mm	AC 122.20	60mm	20mm
AC 121.08	50mm	8mm	AC 123.10	50mm	10mm
AC 121.10	50mm	12mm	AC 123.14	50mm	14mm
AC 121.12	60mm	20mm	AC 123.20	60mm	20mm



CARREL
AC 150.10
 100mm / 4 $\frac{1}{2}$ "



STANDARD
AC 176.14 - AC 176.16



AC 176.14
 140mm / 5 $\frac{1}{2}$ "



AC 176.16
 160mm / 6 $\frac{1}{2}$ "



SPENCER - WELLS
AC 248.13 - AC 249.20



AC 248.13
 130mm / 5"



AC 248.14
 140mm / 5 $\frac{1}{2}$ "



AC 248.15
 150mm / 6"



AC 248.18
 180mm / 7"



AC 248.20
 200mm / 8"



AC 249.13
 130mm / 5"



AC 249.14
 140mm / 5 $\frac{1}{2}$ "



AC 249.15
 150mm / 6"



AC 249.18
 180mm / 7"



AC 249.20
 200mm / 8"

Arterienklemmen
 Artery Forceps
 Pinze emostatiche
 Pinzas hemostáticas

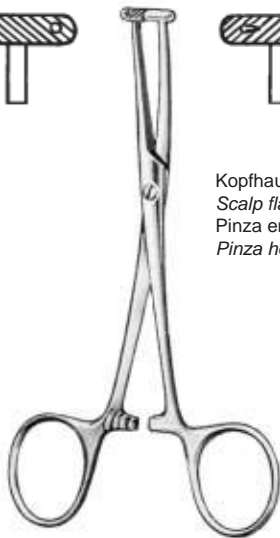

Kopfhautklemme,
 Scalp flap forcep,
 Pinza emostatica per il cuoio capelluto,
 Pinza hemostática para pericraneo

MARTEL
 AC 290.14

140mm / 5½"

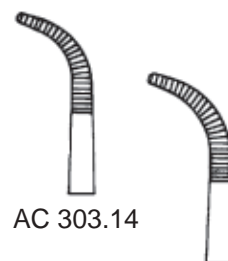

AC 303.14



AC 305.14

BABY - MIXTER
 AC 303.14 - AC 305.14

140mm / 5½"



AC 306.10



AC 307.10

HARTMANN
 AC 306.10 - AC 307.10

100mm / 4¼"



Maul kreuzgerieft,
 Cross serrations,
 Morso con zigrinatura incrociata,
 Bocas con estrías cruzadas

AC 309.12

120mm / 4¾"



HALSTED - MOSQUITO
 AC 310.12 - AC 313.14



AC 310.12
 120mm / 4¾"



AC 310.14
 140mm / 5½"

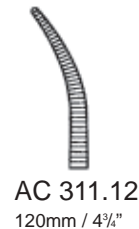

AC 311.12
 120mm / 4¾"



AC 311.14
 140mm / 5½"



AC 312.12
 120mm / 4¾"

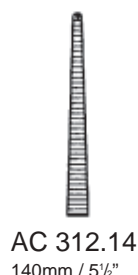

AC 312.14
 140mm / 5½"



AC 313.12
 120mm / 4¾"



AC 313.14
 140mm / 5½"

1:2 Zähne, Teeth, Denti, Dientes

1:2 Zähne, Teeth, Denti, Dientes



HALSTED - MOSQUITO
AC 316.18 - AC 319.21



AC 316.18
 180mm / 7"



AC 316.21
 210mm / 8 1/4"



AC 317.18
 180mm / 7"



AC 317.21
 210mm / 8 1/4"



AC 318.18
 180mm / 7"



AC 318.21
 210mm / 8 1/4"



AC 319.18
 180mm / 7"



AC 319.21
 210mm / 8 1/4"

1:2 Zähne, *Teeth, Denti, Dientes*

1:2 Zähne, *Teeth, Denti, Dientes*

HALSTED, WILLIAM STEWART, * 1852, † 1923

Amerikanischer Chirurg. Konzepte als erster die radikale Mastektomie des Brustkrebses.
 American surgeon. Was the first surgeon to conceive the radical Mastectomy of Brust Cancer.
 Cirujano americano. Ha concepitto per primo la mastectomia radicale nel cancro della mammella.
 Cirujano americano. Primero en concebir la mastectomía del cáncer de mama.



HALSTED - MOSQUITO
AC 320.10 - AC 323.12



AC 320.10
 100mm / 4 1/4"



AC 320.12
 120mm / 4 3/4"



AC 321.10
 100mm / 4 1/4"



AC 321.12
 120mm / 4 3/4"



AC 322.10
 100mm / 4 1/4"



AC 322.12
 120mm / 4 3/4"



AC 323.10
 100mm / 4 1/4"



AC 323.12
 120mm / 4 3/4"

1:2 Zähne, *Teeth, Denti, Dientes*

1:2 Zähne, *Teeth, Denti, Dientes*



PROVIDENCE - HOSPITAL
AC 324.14 - AC 325.14
 140mm / 5½"



LERICHE
AC 326.15 - AC 329.15
 150mm / 6"

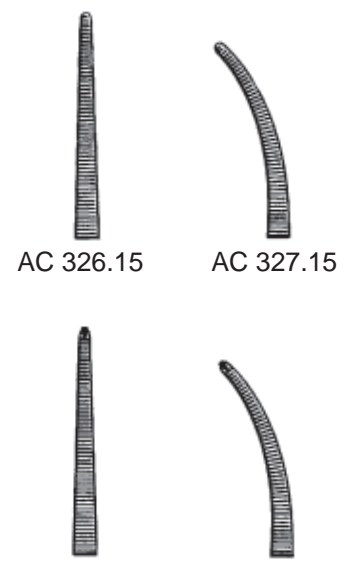

1:2 Zähne, Teeth, Denti, Dientes

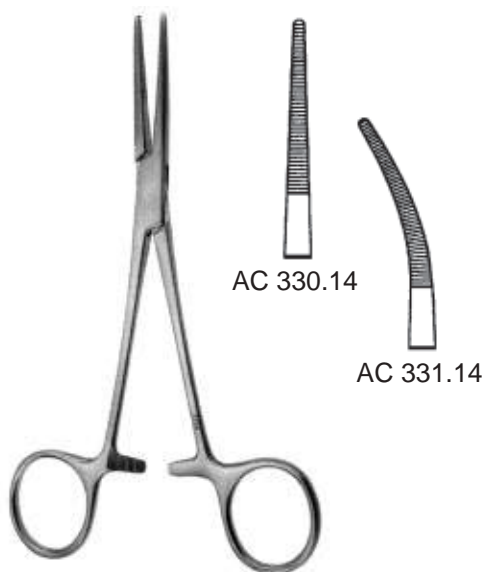

KELLY
AC 330.14 - AC 331.14
 140mm / 5½"

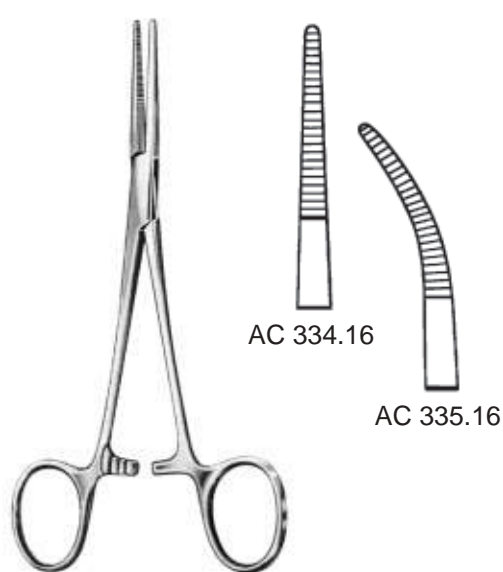

KELLY - RANKIN
AC 334.16 - AC 335.16
 160mm / 6½"



BABY - OVERHOLT
AC 339.14
 140mm / 5½"



CRILE
AC 340.14 - AC 343.14
 140mm / 5½"

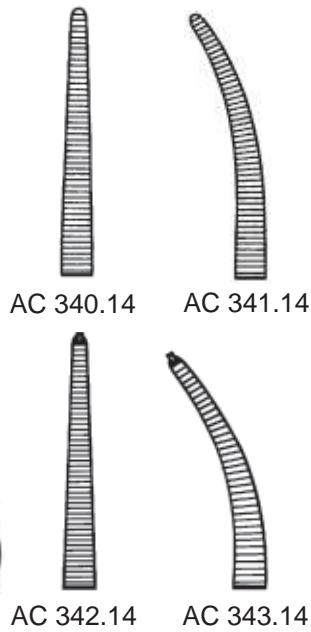

1:2 Zähne, *Teeth, Denti, Dientes*

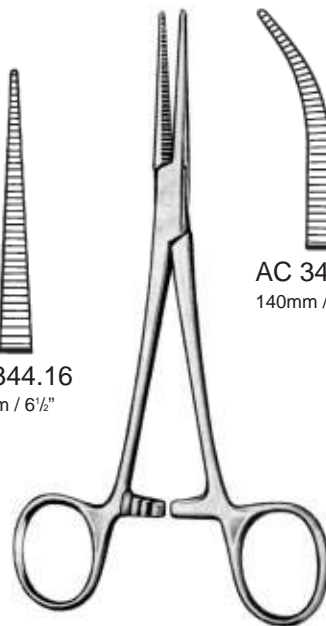
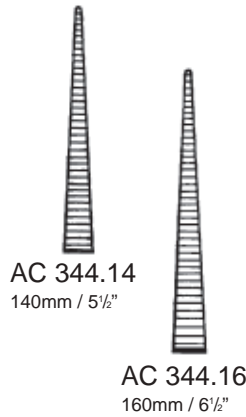

COLLER - CRILE
AC 344.14 - AC 345.16

CRILE - RANKIN
AC 346.16 - AC 347.16
 160mm / 6½"

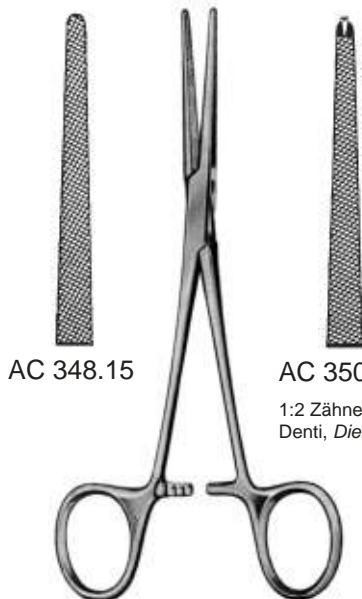
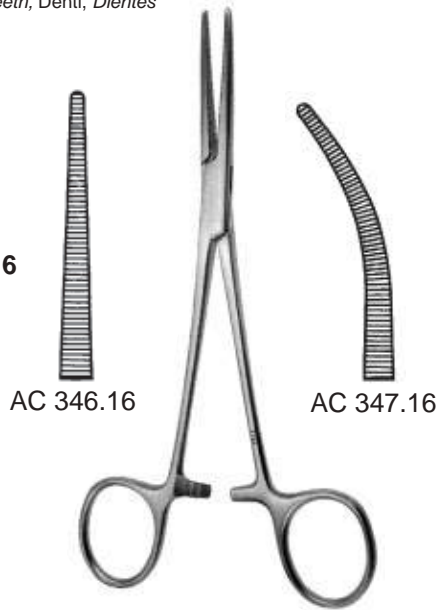

LOVELACE
AC 348.15 - AC 350.15
 150mm / 6"

1:2 Zähne, *Teeth, Denti, Dientes*

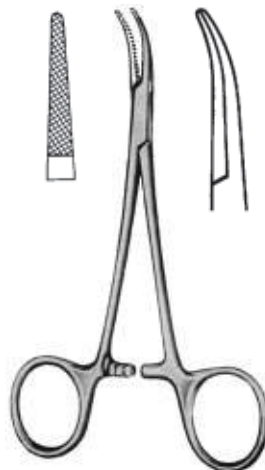

MOSQUITO - DANDY
AC 351.12
 120mm / 4¾"

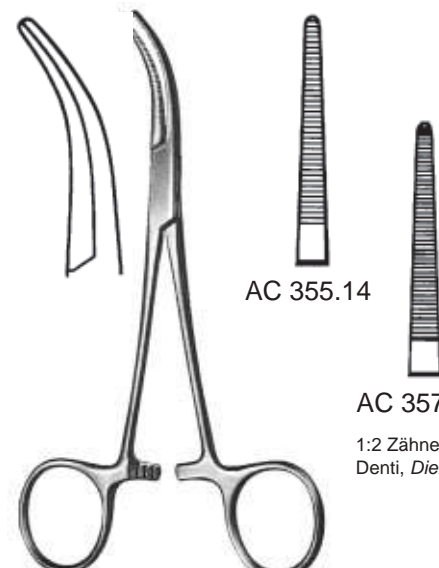

DANDY
AC 355.14 - AC 357.14
 140mm / 5½"

1:2 Zähne, *Teeth, Denti, Dientes*



AC 363.18
 180mm / 7"

AC 363.19
 190mm / 7½"

SCHNIDT
 AC 363.18 - AC 363.19

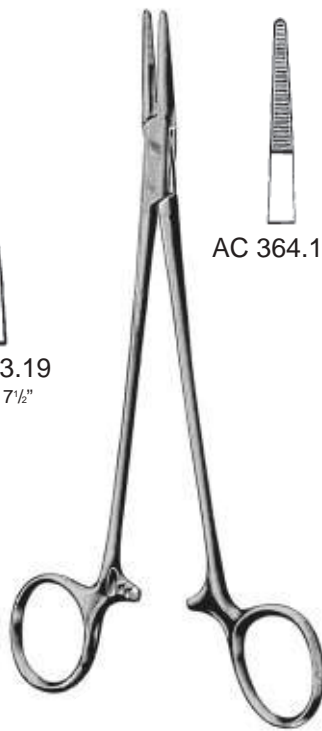

AC 364.18

AC 365.18

ADSON
 AC 364.18 - AC 365.18
 180mm / 7"

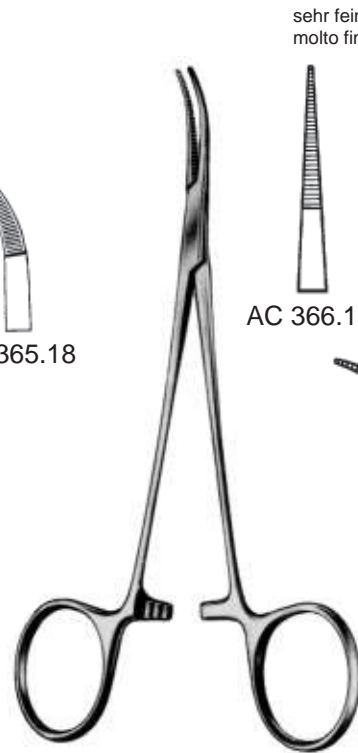

sehr fein, very fine,
 molto fini, muy finas

AC 366.18

AC 367.18

AC 369.18

JACOBSON - ADSON
 AC 366.18 - AC 369.18
 180mm / 7"



FUCHSIG
 AC 369.20 // 200mm / 8"
 AC 369.24 // 240mm / 9½"

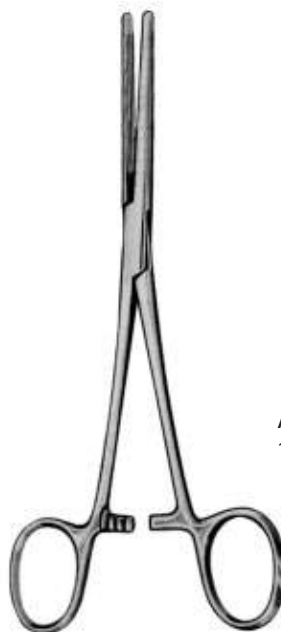

AC 370.16
 160mm / 6½"

AC 370.20
 200mm / 8"



AC 371.16
 160mm / 6½"



AC 371.20
 200mm / 8"

ROCHESTER - CARMALT
 AC 370.16 - AC 371.20

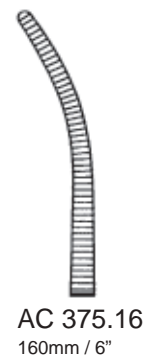
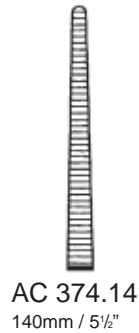
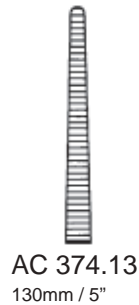

PEAN
AC 374.13 - AC 375.16
 grazil, delicate, delicato, delgado

PEAN (ROCHESTER) * 1830, † 1898
 Französischer Chirurg in der Gynäkologie. Entwickler der Gefäßklemme.
 French Gynecologist. Inventor of the Vessel Forceps.
 Cirujano francés de la Ginecología. Líder en el desarrollo de la pinza emostática.
 Cirujano francés en la ginecología. Líder en evolucionar la pinza hemostática.

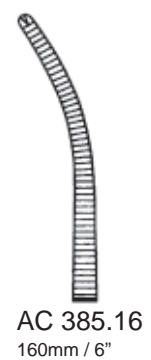
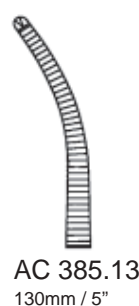
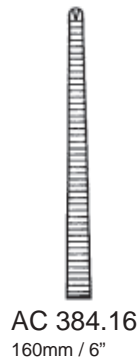
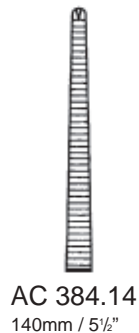
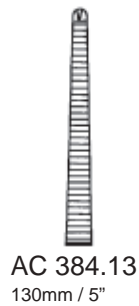

KOCHER
AC 384.13 - AC 385.16
 grazil, delicate, delicato, delgado

1:2 Zähne, Teeth, Denti, Dientes

1:2 Zähne, Teeth, Denti, Dientes



PEAN - NIPPON
 AC 380.14 - AC 381.18

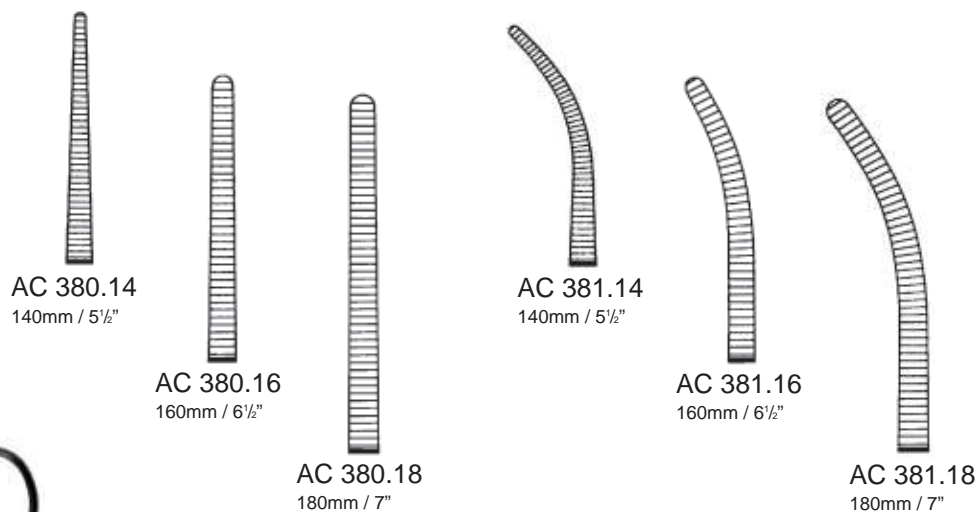

KOCHER (OCHSENER) * 1841, † 1917

Schweizer Chirurg. Erforscher der Schilddrüsenkrankheit. Nobelpreis 1909.
 Swiss Surgeon. Investigated Thyroid gland disease. Nobel Prize Winner 1909.
 Chirurgo svizzero. Ricercatore della malattia struma tiroide. Primo Nobel 1909.
 Cirujano suizo. Escudrinadore de la enfermedad de la glándula tiroides. Premio Nobel 1909.



KOCHER - NIPPON
 AC 382.14 - AC 383.18

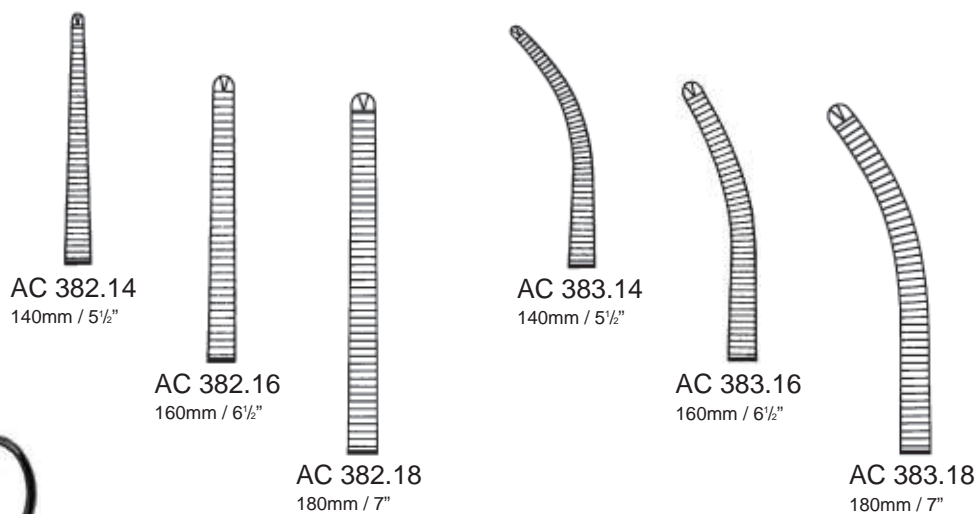

1:2 Zähne, Teeth, Denti, Dientes

1:2 Zähne, Teeth, Denti, Dientes



AC 390.20
 200mm / 8"



AC 390.22
 220mm / 8³/₄"



AC 390.24
 240mm / 9¹/₂"



AC 390.26
 260mm / 10¹/₄"



AC 391.20
 200mm / 8"



AC 391.22
 220mm / 8³/₄"



AC 391.24
 240mm / 9¹/₂"



AC 391.26
 260mm / 10¹/₄"



BENGOLEA
 AC 390.20 - AC 393.26



AC 392.20
 200mm / 8"



AC 392.22
 220mm / 8³/₄"



AC 392.24
 240mm / 9¹/₂"



AC 392.26
 260mm / 10¹/₄"

1:2 Zähne, Teeth, Denti, Dientes



AC 393.20
 200mm / 8"



AC 393.22
 220mm / 8³/₄"



AC 393.24
 240mm / 9¹/₂"



AC 393.26
 260mm / 10¹/₄"

1:2 Zähne, Teeth, Denti, Dientes

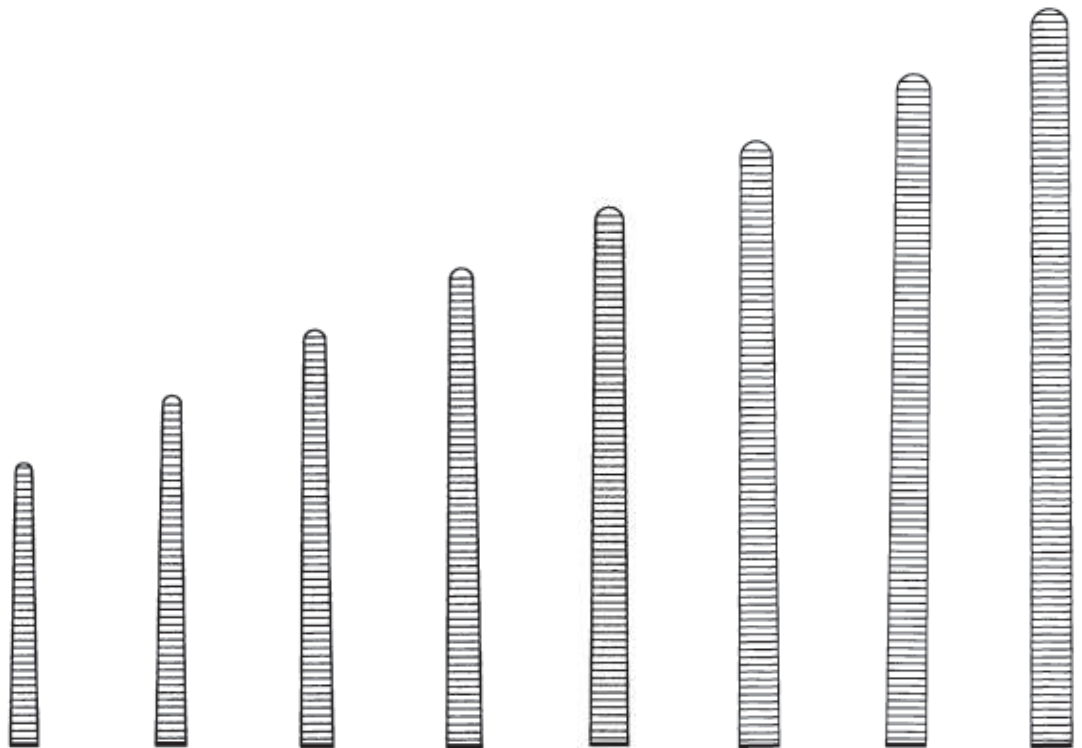

AC 410.14 140mm / 5½"
 AC 410.16 160mm / 6½"
 AC 410.18 180mm / 7"
 AC 410.20 200mm / 8"
 AC 410.22 220mm / 8¾"
 AC 410.24 240mm / 9½"
 AC 410.26 260mm / 10¼"
 AC 410.30 300mm / 12"

PEAN
AC 410.14 - AC 410.30



PEAN - KOCHER

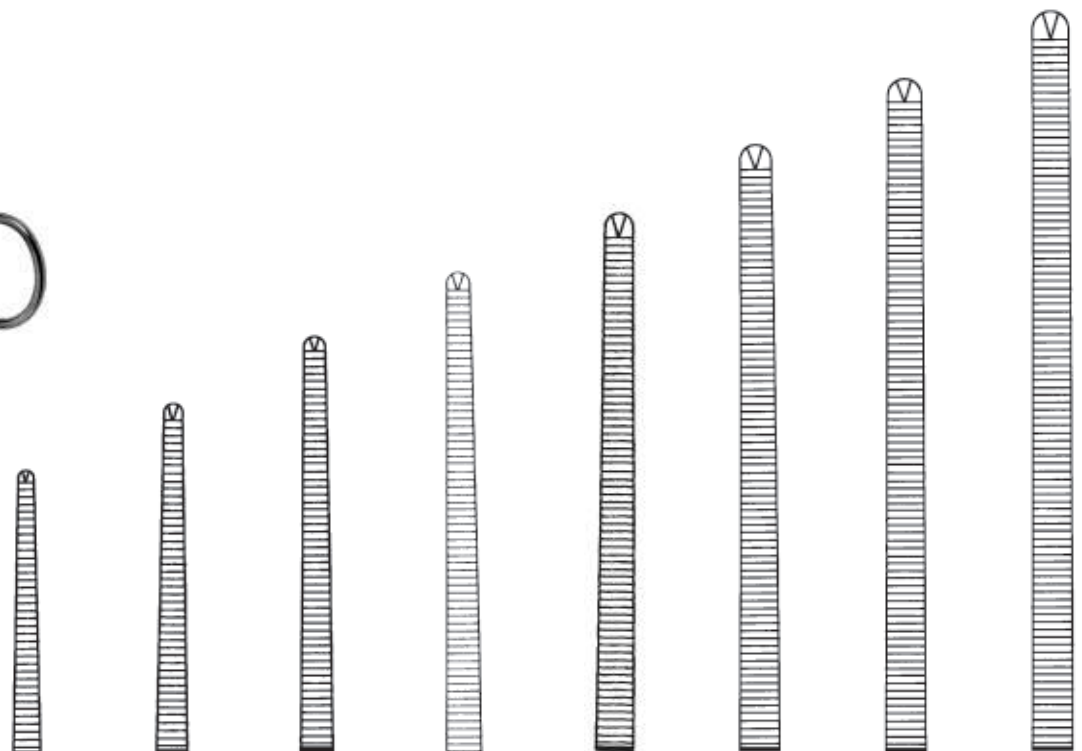

AC 414.14 140mm / 5½"
 AC 414.16 160mm / 6½"
 AC 414.18 180mm / 7"
 AC 414.20 200mm / 8"
 AC 414.22 220mm / 8¾"
 AC 414.24 240mm / 9½"
 AC 414.26 260mm / 10¼"
 AC 414.30 300mm / 12"

KOCHER
AC 414.14 - AC 414.30

1:2 Zähne, Teeth, Denti, Dientes

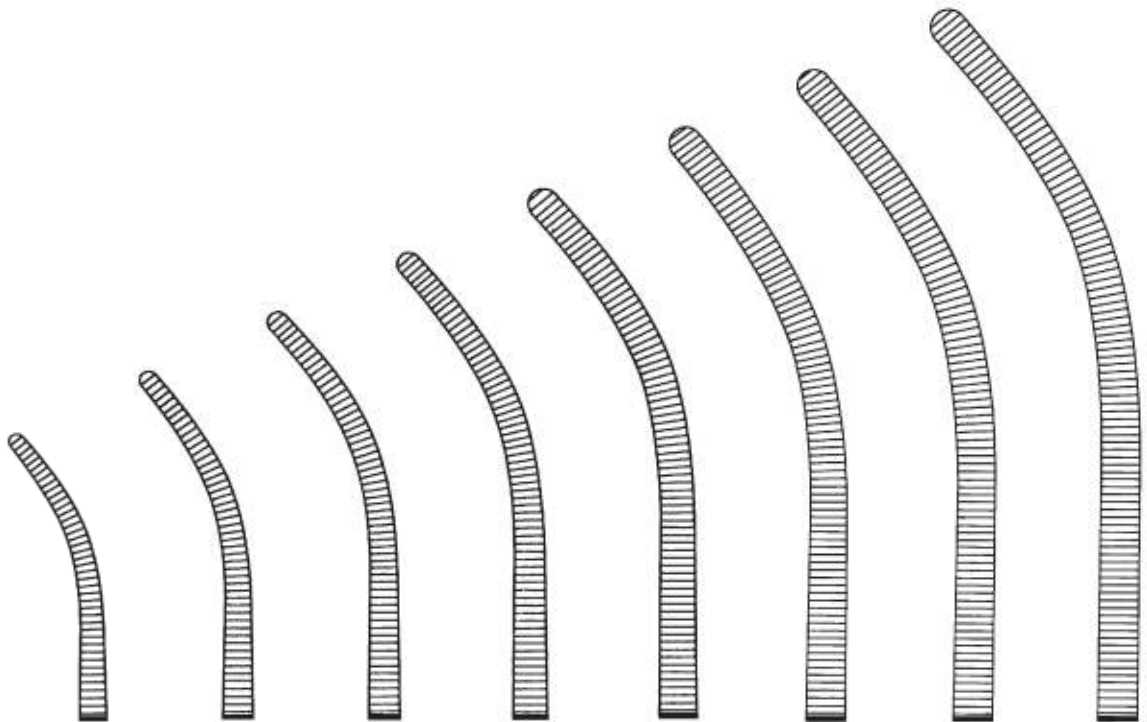

AC 411.14	AC 411.16	AC 411.18	AC 411.20	AC 411.22	AC 411.24	AC 411.26	AC 411.30
140mm / 5½"	160mm / 6½"	180mm / 7"	200mm / 8"	220mm / 8¾"	240mm / 9½"	260mm / 10¼"	300mm / 12"

PEAN
AC 411.14 - AC 411.30



PEAN - KOCHER

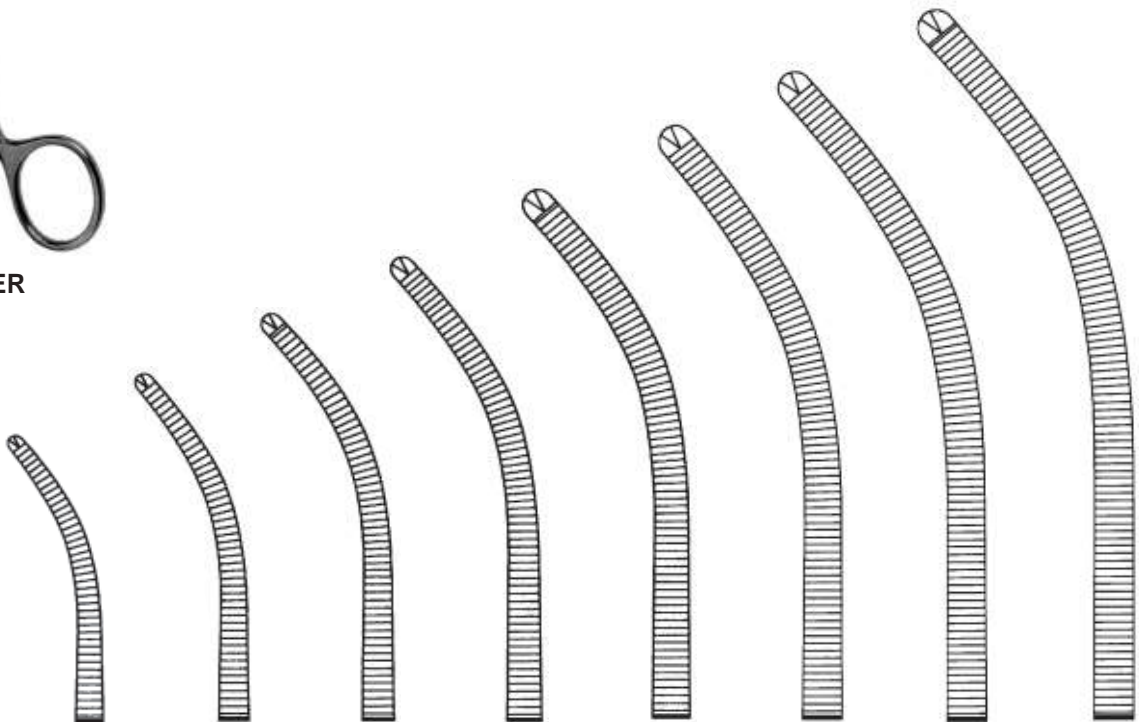

AC 415.14	AC 415.16	AC 415.18	AC 415.20	AC 415.22	AC 415.24	AC 415.26	AC 415.30
140mm / 5½"	160mm / 6½"	180mm / 7"	200mm / 8"	220mm / 8¾"	240mm / 9½"	260mm / 10¼"	300mm / 12"

KOCHER
AC 415.14 - AC 415.30

1:2 Zähne, Teeth, Denti, Dientes



OVERHOLT - S
 AC 417.01 - AC 417.05



AC 417.01
 180mm / 7"

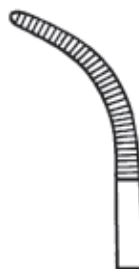

AC 417.02
 200mm / 8"



AC 417.03
 210mm / 8 1/4"

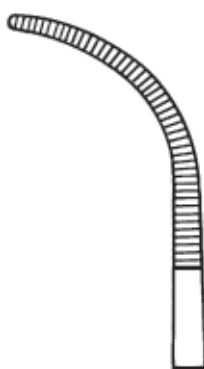

AC 417.04
 220mm / 8 3/4"

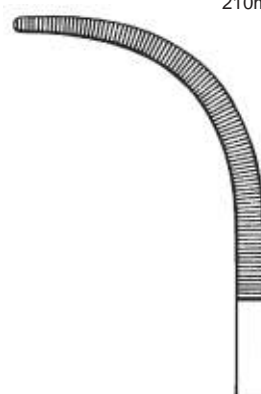

AC 417.05
 240mm / 9 1/2"



MIXTER // ADSON
 AC 419.18 - AC 421.18



AC 419.18
 180mm / 7"
MIXTER



AC 421.14
 140mm / 5 1/2"



AC 421.18
 180mm / 7"

ADSON

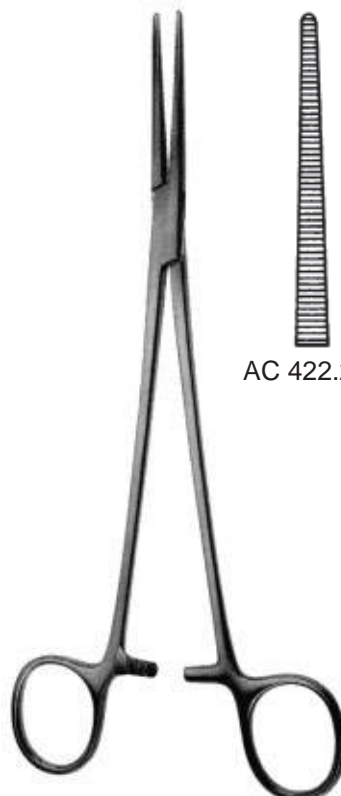

HEISS
 AC 422.20 - AC 427.20
 200mm / 8"



AC 422.20



AC 423.20



AC 425.20



AC 426.20



AC 427.20

1:2 Zähne, Teeth, Denti, Dientes



OVERHOLT - MIXTER
 AC 427.21

210mm / 8 1/4"

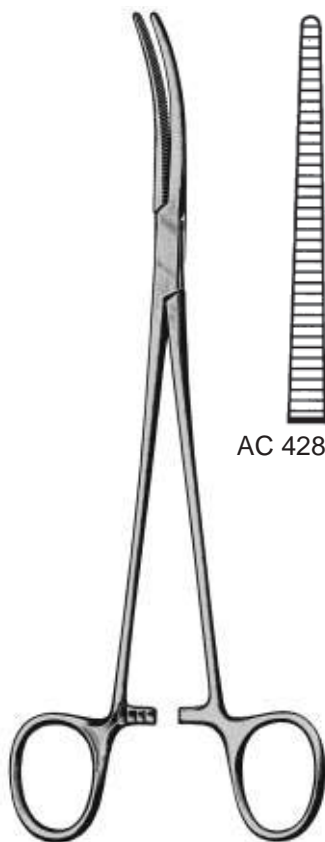

ROBERTS
 AC 428.22 - AC 429.22

220mm / 8 3/4"

AC 428.22

AC 429.22

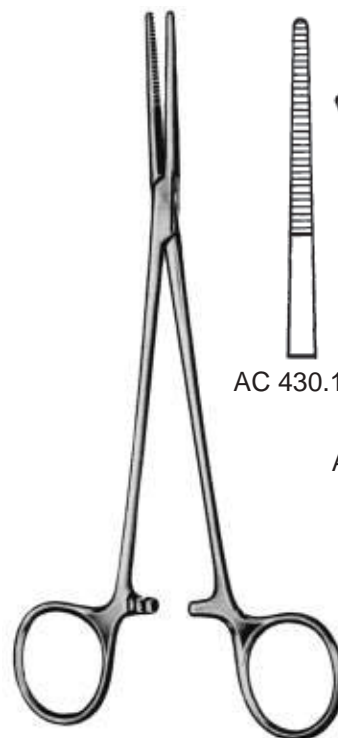

BIRKETT
 AC 430.19 - AC 431.19

190mm / 7 1/2"

AC 430.19

AC 431.19



SAROT
 AC 432.24 - AC 433.24

240mm / 9 1/2"

AC 432.24

AC 433.24



CRAFOORD
 AC 439.18 - AC 439.24

AC 439.18
 180m / 7"

AC 439.24
 240m / 9 1/2"

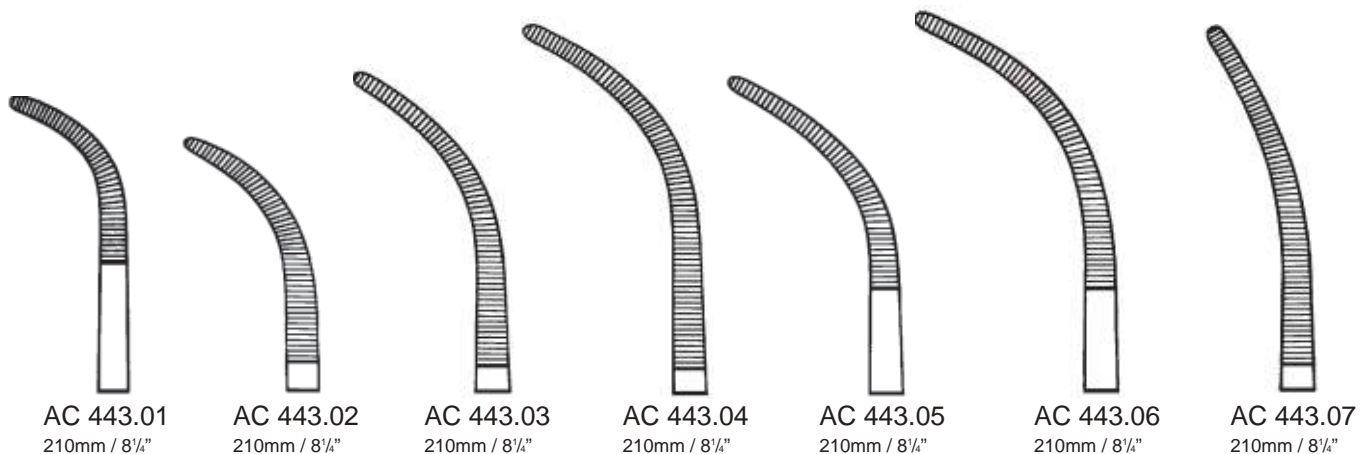

OVERHOLT - GEISSENDOERFER
 AC 443.01 - AC 447.07

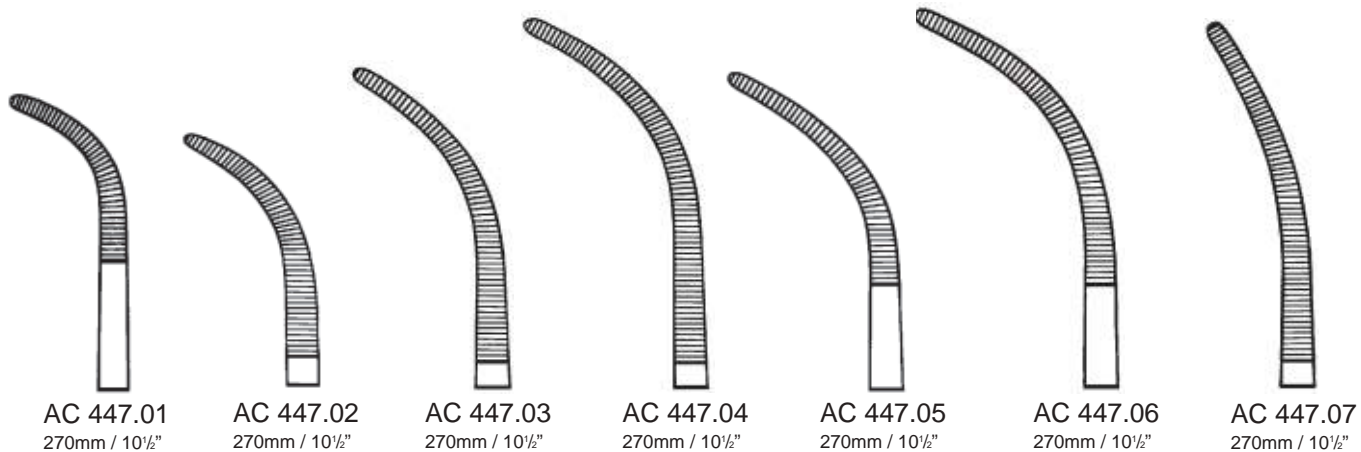



GEMINI
AC 451.13 - AC 451.28



AC 451.13
 130mm / 5"



AC 451.16
 160mm / 6½"



AC 451.18
 180mm / 7"



AC 451.20
 200mm / 8"



AC 451.23
 230mm / 9"



AC 451.25
 250mm / 10"



AC 451.28
 280mm / 11"



MINI - GEMINI
AC 453.18 - AC 453.28



AC 453.18
 180mm / 7"



AC 453.22
 220mm / 8¾"



AC 453.25
 250mm / 10"



AC 453.28
 280mm / 11"



RUMEL
 AC 461.01 - AC 461.05
 230mm / 9"

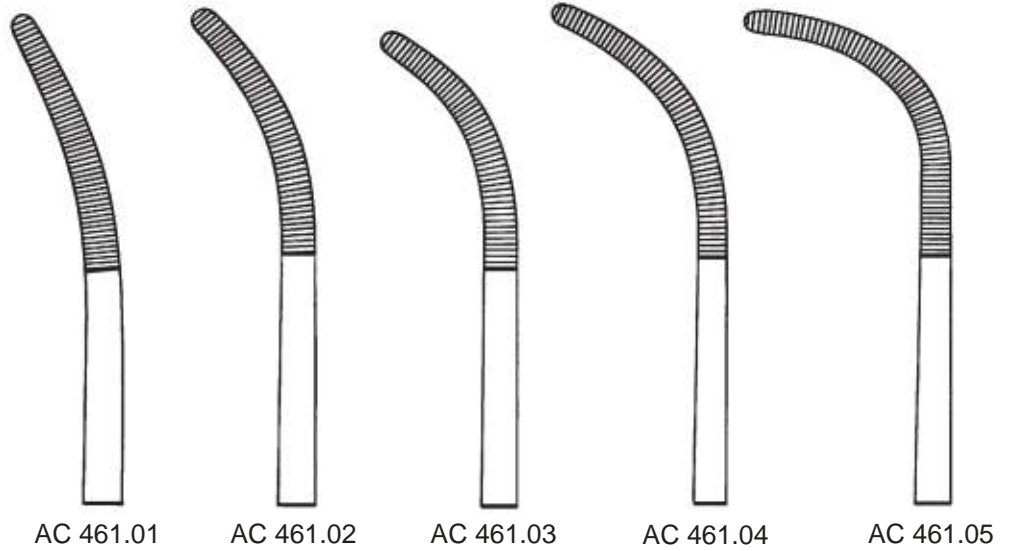

AC 461.01 AC 461.02 AC 461.03 AC 461.04 AC 461.05



TOENNIS
 AC 462.21 - AC 465.26

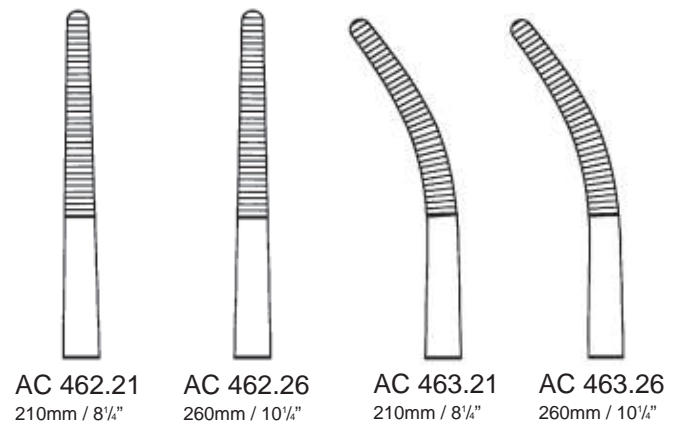

AC 462.21 AC 462.26 AC 463.21 AC 463.26
 210mm / 8 1/4" 260mm / 10 1/4" 210mm / 8 1/4" 260mm / 10 1/4"

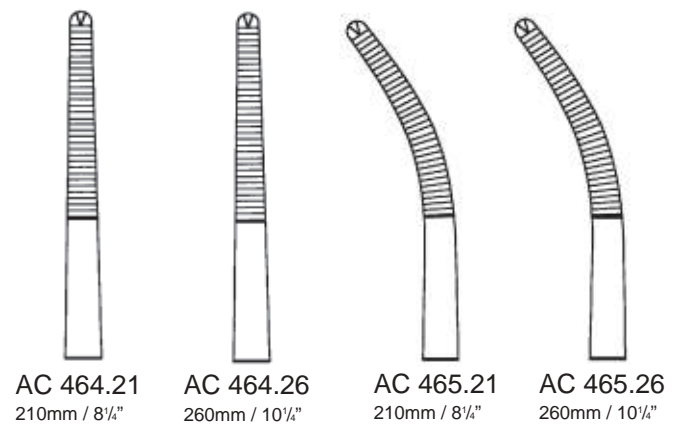

AC 464.21 AC 464.26 AC 465.21 AC 465.26
 210mm / 8 1/4" 260mm / 10 1/4" 210mm / 8 1/4" 260mm / 10 1/4"

1:2 Zähne, Teeth, Denti, Dientes



AC 469.01

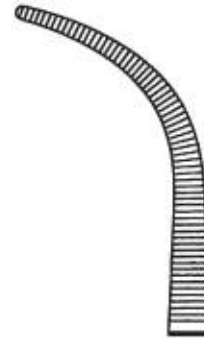

AC 469.02

ZENKER
AC 469.01 - AC 469.02
290mm / 11 1/4"



MIXTER - BABY
AC 471.14
140mm / 5 1/2"



MIXTER
AC 473.15 - AC 473.19



AC 473.15
150mm / 6"

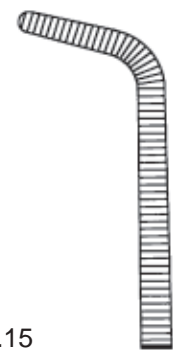

AC 473.19
190mm / 7 1/2"



MIXTER - O'SHAUGNESSY
AC 479.19
 190mm / 7½"



MIXTER
AC 483.22
 220mm / 8¾"



MIXTER
AC 485.23
 230mm / 9"

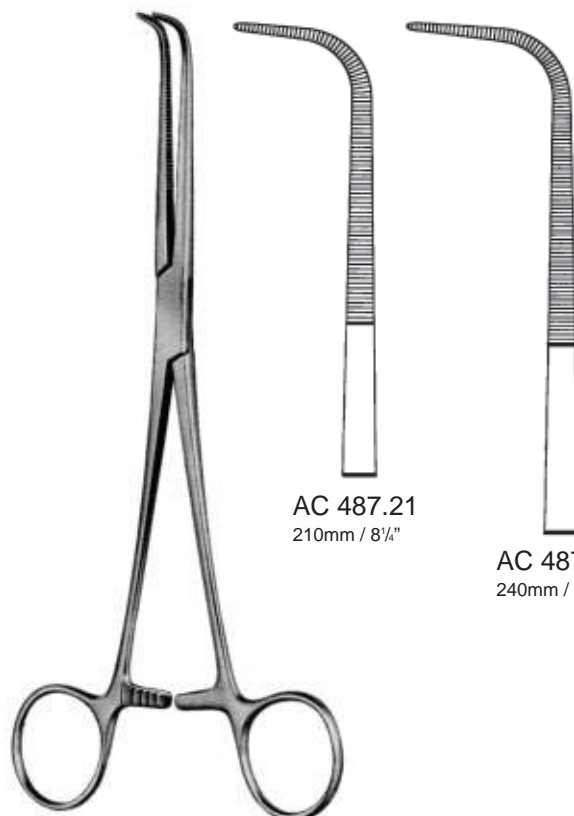

AC 487.21
 210mm / 8¼"

AC 487.24
 240mm / 9½"

WICKSTRÖM
AC 487.21 - AC 487.24

Arterien-, Bronchus- und Gallenkanalklemmen
Artery Forceps, Bronchus and Gall Duct Clamps
 Pinze emostatiche, Pinze per bronchi e vie biliari
Pinzas hemostáticas, Pinzas para bronquios y conducto biliar



AC 491.22
 220mm / 8³/₄"

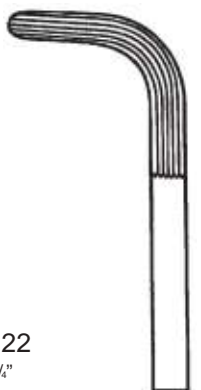

AC 493.25
 250mm / 10"

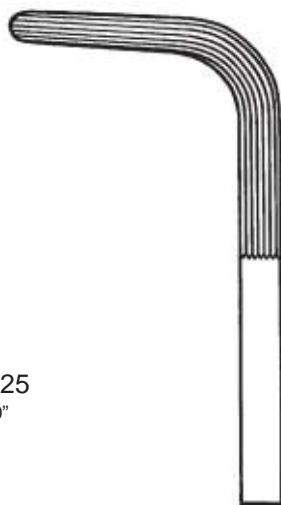

AC 495.28
 280mm / 11"

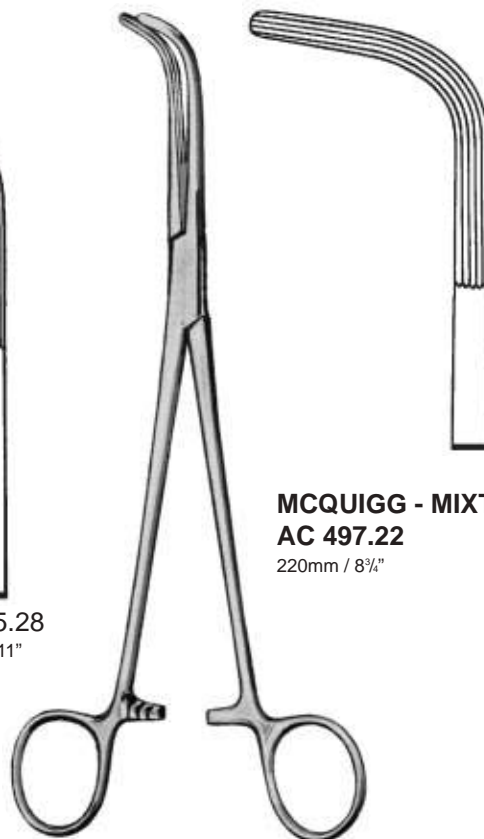

MCQUIGG - MIXTER
AC 497.22
 220mm / 8³/₄"

MIXTER
AC 491.22 - AC 495.28



LOWER
AC 501.18
 180mm / 7"



LAHEY
AC 511.19 - AC 511.23



AC 511.19
 190mm / 7¹/₂"



AC 511.23
 230mm / 9"

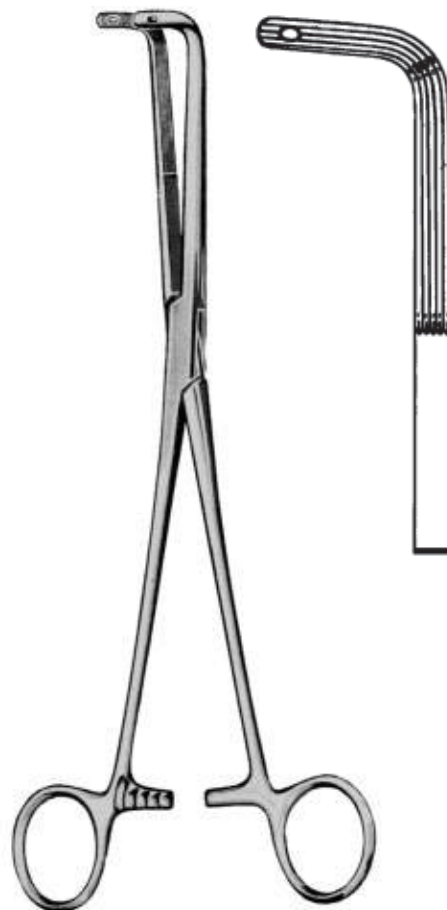

FINOCCHIETTO
AC 521.24
 240mm / 9¹/₂"

Nierenstielklemmen
 Kidney Pedicle Clamp Forceps
 Pinze per peduncoli renali
 Pinzas para pedúnculos renales



AC 529.23
 230mm / 9"



AC 529.24
 240mm / 9½"

ATRAUMATIC

GUYON
 AC 529.23 - AC 529.24

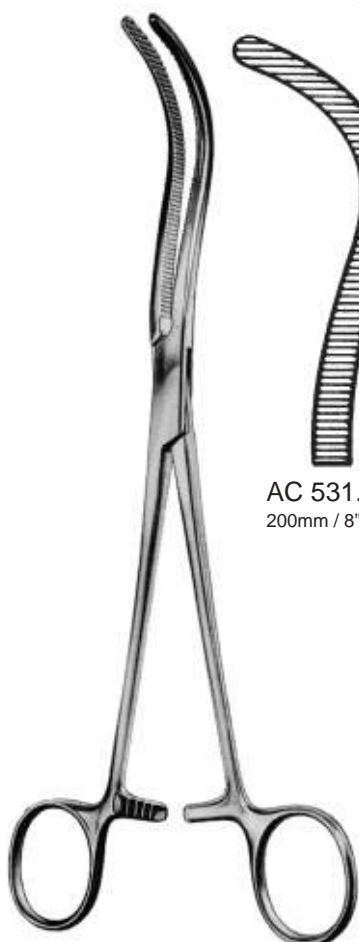

AC 531.20
 200mm / 8"

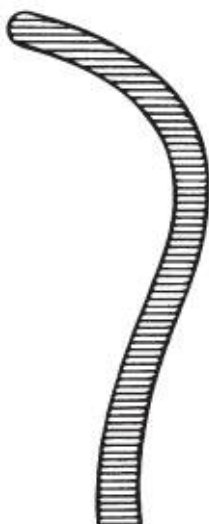

AC 531.22
 220mm / 8½"

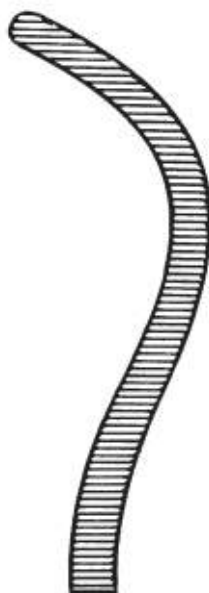

AC 531.24
 240mm / 9½"

GUYON
 AC 531.20 - AC 531.24



GUYON
 AC 533.23
 230mm / 9"



STILLE
AC 537.22
220mm / 8³/₄"

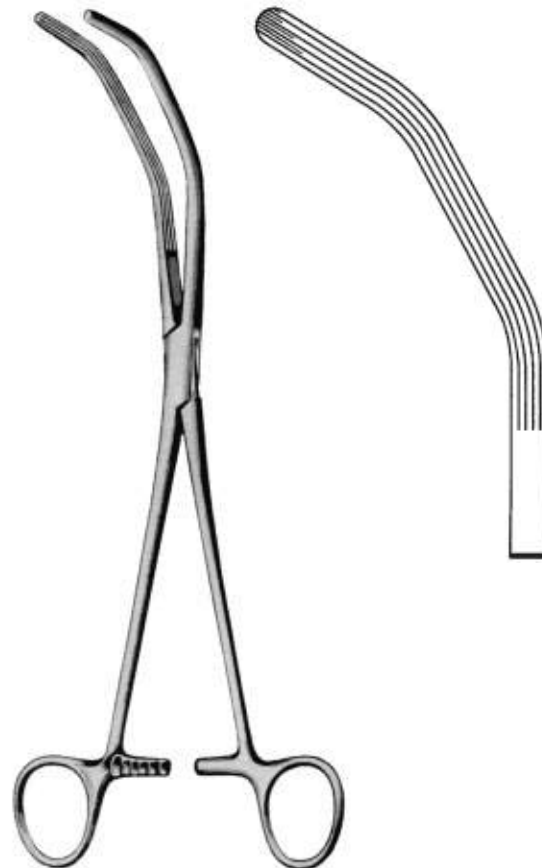

HERRICK
AC 549.23
230mm / 9"



GRAY
AC 561.22 - AC 563.23

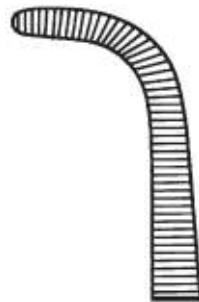

AC 561.22
220mm / 8 $\frac{3}{4}$ "

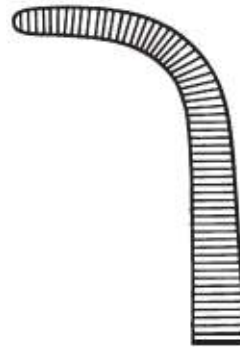

AC 563.23
230mm / 9"



DESJARDINS
AC 571.21
210mm / 8 $\frac{1}{4}$ "

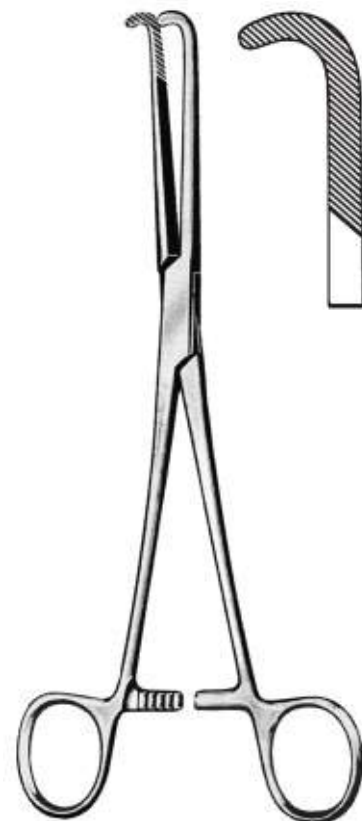

NISSEN
AC 573.23
230mm / 9"



KELLY
AC 577.19 - AC 581.24



AC 577.19
190mm / 7½"



AC 579.19
190mm / 7½"



AC 581.19
190mm / 7½"



AC 577.22
220mm / 8¾"



AC 579.22
220mm / 8¾"



AC 581.22
220mm / 8¾"



AC 577.24
240mm / 9½"



AC 579.24
240mm / 9½"



AC 581.24
240mm / 9½"



LAWRENCE
AC 583.28
280mm / 11"



MEEKER
AC 585.28
280mm / 11"

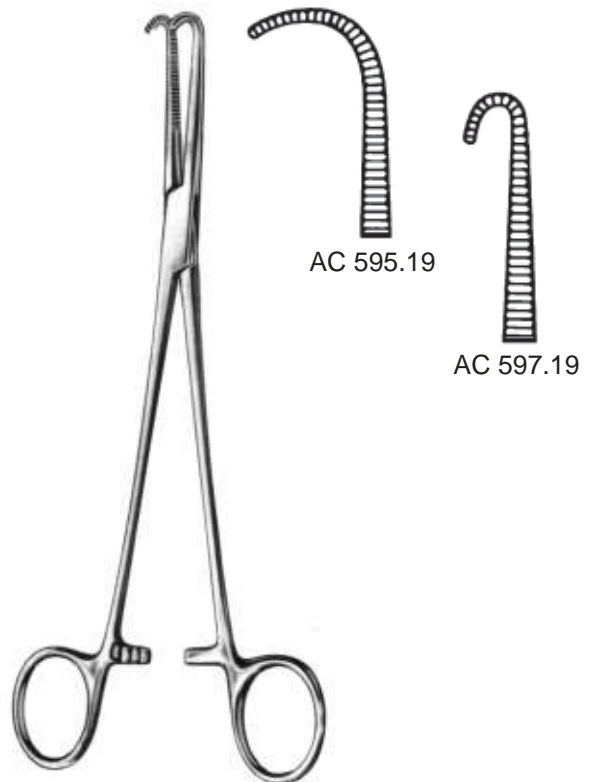

NEGUS
AC 595.19 - AC 597.19
190mm / 7½"

Klemmzangen, Hysterektomie- und Vaginalklemmen
Clamp Forceps, Hysterectomy and Vaginal Forceps
Pinze emostatiche, Pinze per isterectomia e vaginali
Pinzas-clamps, Pinzas para histerectomía y vaginales

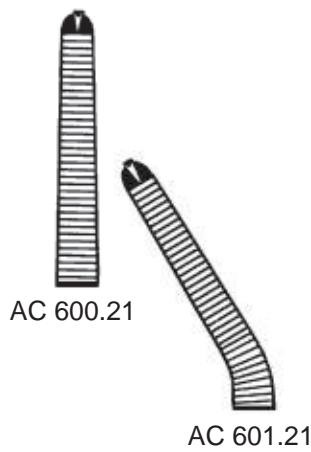

PHANEUF
AC 600.21 - AC 601.21
 210mm / 8¹/₄"



HEANEY
AC 613.19 - AC 615.23

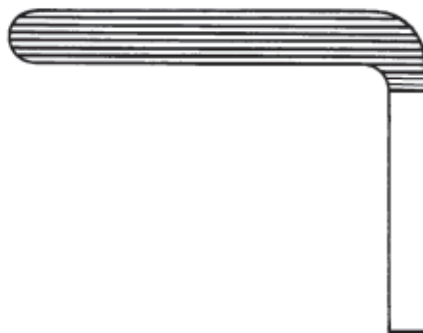
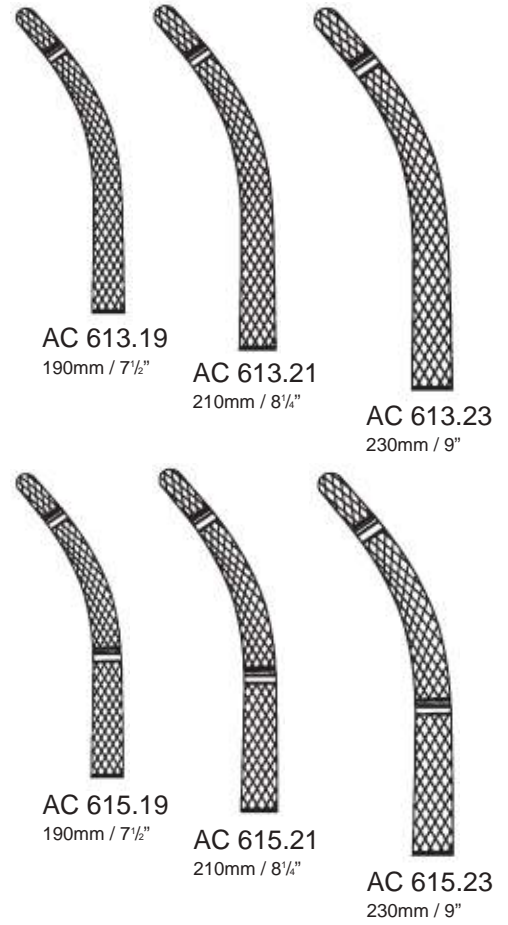

WERTHEIM - CULLEN
AC 625.21
 210mm / 8¹/₄"



WERTHEIM
AC 633.24
 240mm / 9¹/₂"

ATRAUMATIC



ROGERS
AC 635.10 - AC 637.40



AC 635.10
220mm / 8³/₄"



AC 635.20
210mm / 8¹/₄"



AC 635.30
210mm / 8¹/₄"



AC 635.40
200mm / 8"



AC 637.10
250mm / 10"



AC 637.20
250mm / 10"



AC 637.30
240mm / 9¹/₂"



AC 637.40
230mm / 9"



MOYNIHAN
 AC 671.23 - AC 673.24

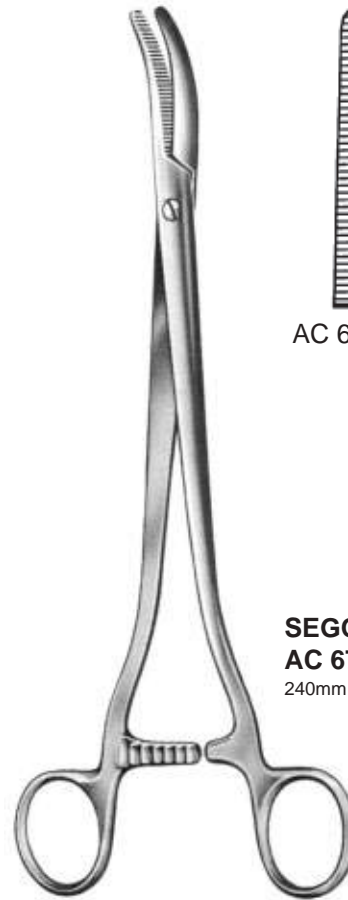
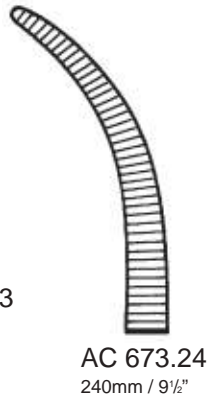

SEGOND - LANDAU
 AC 676.24 - AC 677.24
 240mm / 9½"

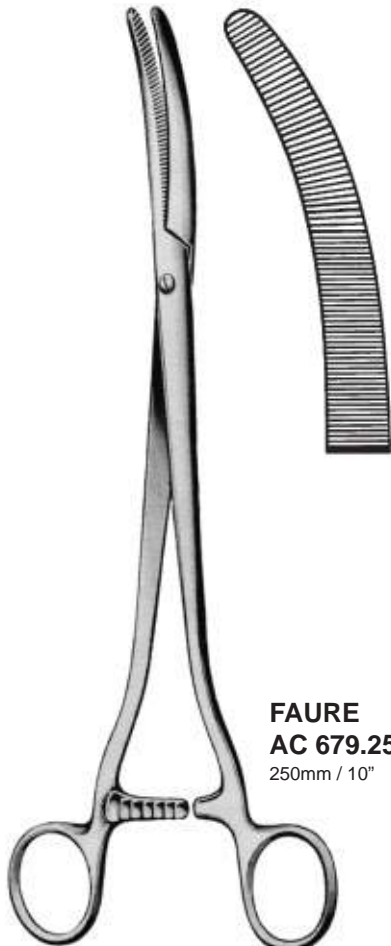
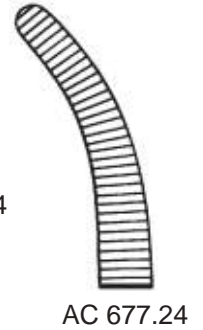

FAURE
 AC 679.25
 250mm / 10"



WERTHEIM
 AC 697.25
 250mm / 10"

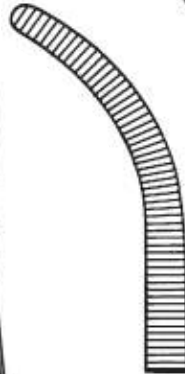

WERTHEIM
 AC 717.22 - AC 719.23

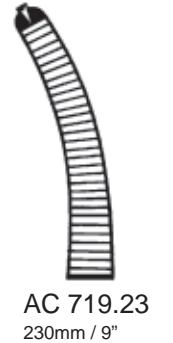

leicht gebogen, stärker gebogen,
slightly curved, more curved,
curva leggera, curva forte,
curva ligeramente más curva
 1:2 Zähne, *Teeth, Denti, Dientes*

Peritoneumklemmen
Peritoneal Clamp Forceps
Pinze per peritoneo
Pinzas-clamps para peritoneo



JOHANN MIKULICZ FREIHERR VON RADECKI, * 1850, † 1905
 Polnischer Chirurg. *Polish Surgeon. Chirurgo polacco. Cirujano polaco.*

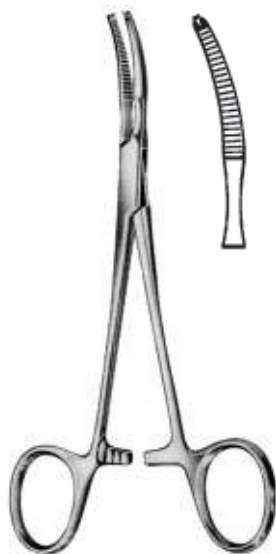

BABY - MIKULICZ
AC 721.14
 140mm / 5½"

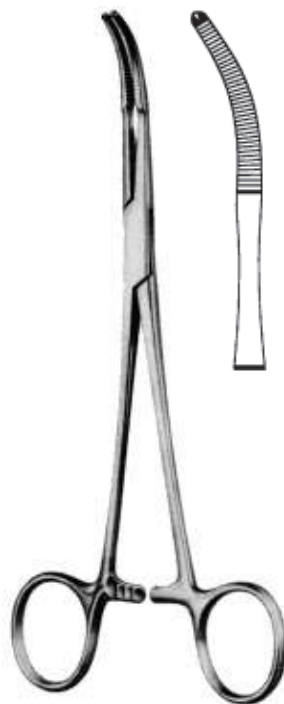

MIKULICZ
AC 725.18
 180mm / 7"

1:2 Zähne, *Teeth, Denti, Dientes*

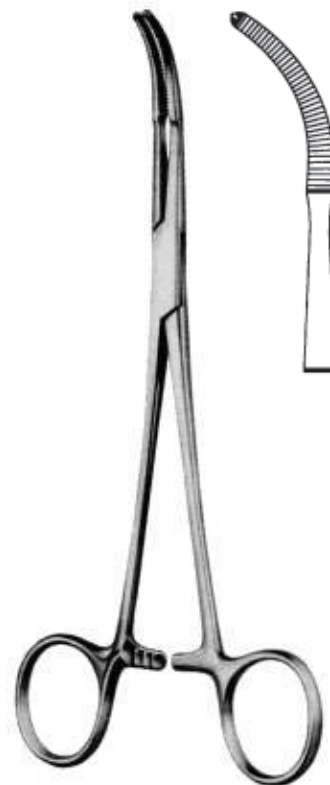

MIKULICZ
AC 727.20
 200mm / 8"

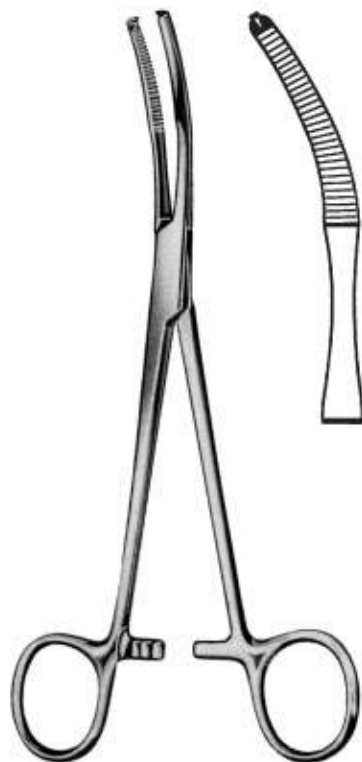

MIKULICZ
AC 745.20
 200mm / 8"



MIKULICZ
AC 749.21
 210mm / 8½"

1:2 Zähne, *Teeth, Denti, Dientes*

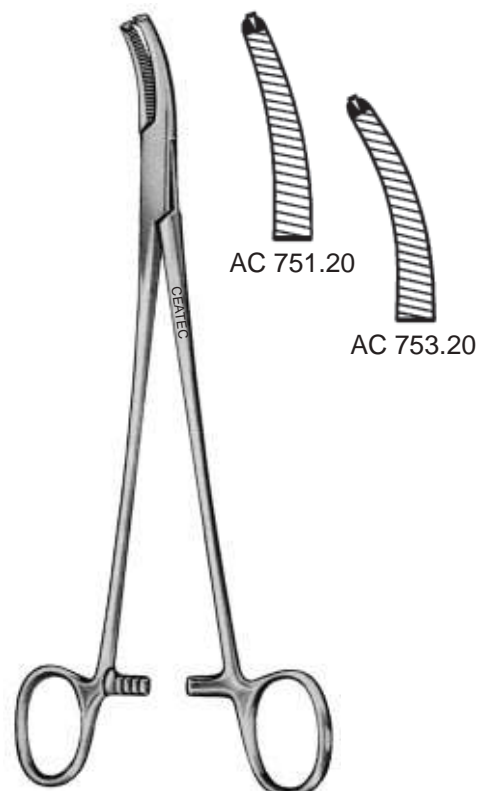

FAURE
AC 751.20 - AC 753.20
 200mm / 8"



SCHAEDEL
AC 875.09
90mm / 3½"



ENGL. MODELL
AC 877.09
90mm / 3½"



JONES
AC 881.05 // 50mm / 2"
AC 881.09 // 90mm / 3½"



JONES - SPEZIELL
AC 883.09
90mm / 3½"

Mit Schlauch- oder Kabelhalter,
With clip for tubing or cable,
Con portatubo o portacavo,
Con porta-tubo o porta-cable



Graziles Modell,
Delicate pattern,
Modello delicato,
Modelo delgado

AC 909.11 // 110mm / 4½"
AC 909.13 // 130mm / 5"



Mit Schlauch- oder Kabelhalter,
With clip for tubing or cable,
Con portatubo o portacavo,
Con porta-tubo o porta-cable

AC 913.11
110mm / 4½"



BACKHAUS
AC 915.08 // 80mm / 3¼"
AC 915.11 // 110mm / 4½"
AC 915.13 // 130mm / 5"
AC 915.15 // 150mm / 6"



ROEDER
AC 917.13 // 130mm / 5"
AC 917.15 // 150mm / 6"

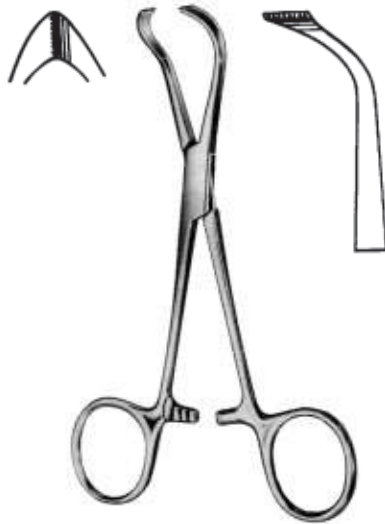

LORNA
AC 919.10 // 100mm / 4 $\frac{1}{8}$ "
AC 919.13 // 130mm / 5"



BERNHARD
AC 921.16
160mm / 6 $\frac{1}{2}$ "



DOYEN
AC 922.18
180mm / 7"



TOHOKU
AC 923.10 // 100mm / 4 $\frac{1}{8}$ "
AC 923.13 // 130mm / 5"



PEERS - BERTRAM
AC 925.14
140mm / 5 $\frac{1}{2}$ "



LANE
AC 935.15 // 150mm / 6"
AC 935.20 // 200mm / 8"



AC 940.14
140mm / 5½"

Mit extrem langer Sperre,
With extra long ratchet,
Con cremagliera extra lunga,
Con cremallera extra larga

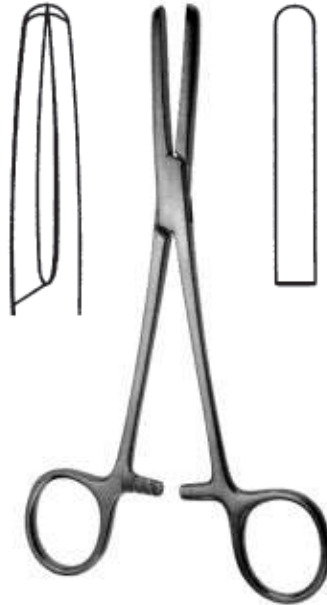

PRESBYTERIAN
AC 942.16
160mm / 6½"



GUNNAR - HEY
AC 943.18
180mm / 7"

Schlauchroller,
Tube milking roller,
Pinza presa-tubi con rulli,
Rodillo para tubos



SPEZIAL
AC 944.15 - AC 944.20

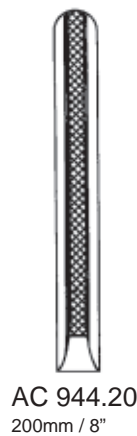
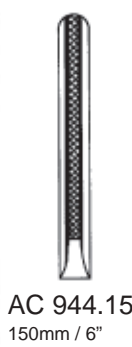

SPEZIAL
AC 946.15 - AC 946.20

Mit Schutzbügel, With safety guard,
Con protezione, Con estribo de protección

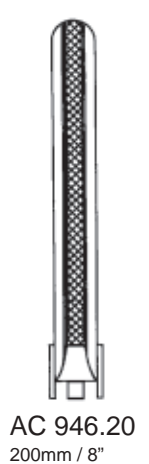



TUPFER-, KORNZANGEN
SWAB-, DRESSING FORCEPS
PINZE PER TAMPONI
PINZAS PARA TAMPONES

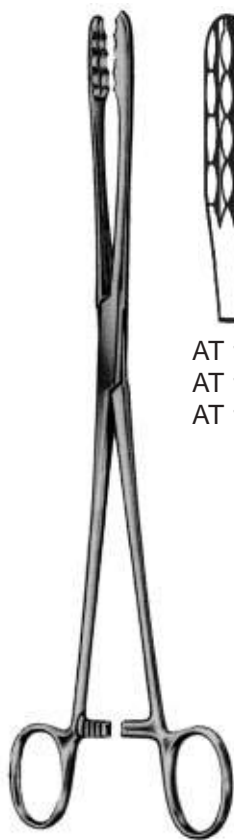

AT 100.22 // 220mm / 8³/₄"
 AT 100.25 // 250mm / 10"
 AT 100.27 // 270mm / 10¹/₂"

ULRICH
AT 100.22 - AT 101.27

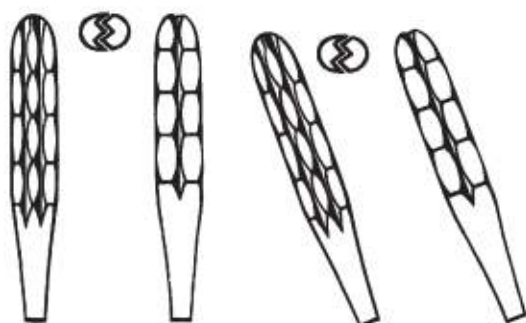

AT 101.22 // 220mm / 8³/₄"
 AT 101.25 // 250mm / 10"
 AT 101.27 // 270mm / 10¹/₂"

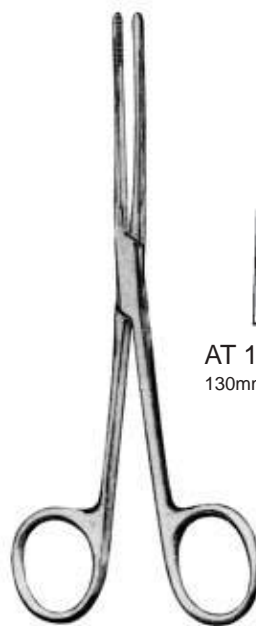

AT 110.13
 130mm / 5"

AT 110.16
 160mm / 6¹/₂"

AT 110.18
 180mm / 7"

LISTER
AT 110.13 - AT 110.18

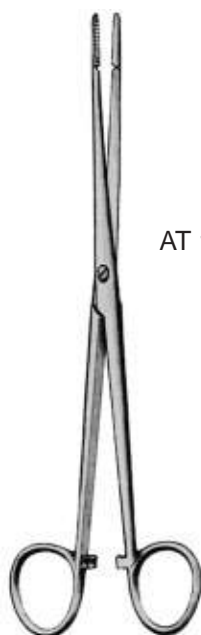

WALTON
AT 120.17 - AT 121.17
 170mm / 6³/₄"

AT 120.17



AT 121.17



DUPLAY
AT 130.20 - AT 131.20
 200mm / 8"

AT 130.20



AT 131.20



GROSS - MAIER
 AT 222.20 - AT 223.27

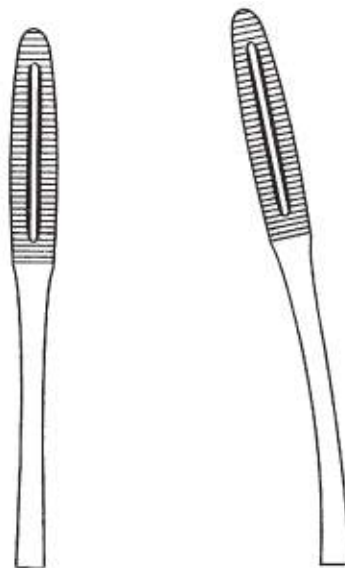

AT 222.20 // 200mm / 8"	AT 223.20 // 200mm / 8"
AT 222.22 // 220mm / 8 ³ / ₄ "	AT 223.22 // 220mm / 8 ³ / ₄ "
AT 222.25 // 250mm / 10"	AT 223.25 // 250mm / 10"
AT 222.27 // 270mm / 10 ¹ / ₂ "	AT 223.27 // 270mm / 10 ¹ / ₂ "

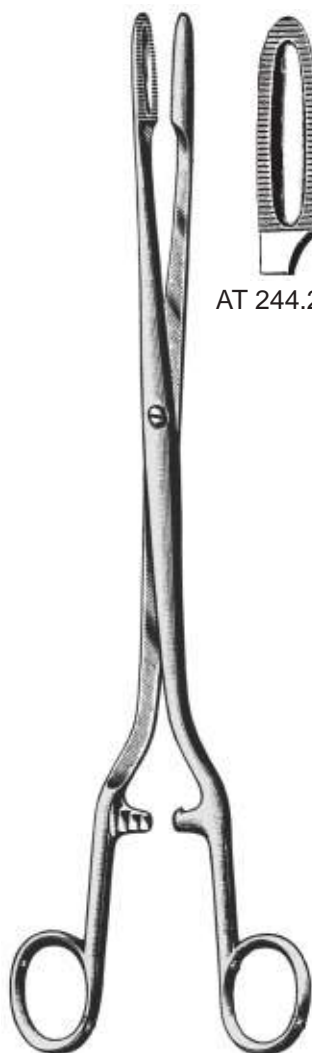

SIMS - MAIER
 AT 244.28 - AT 245.28
 280mm / 11"

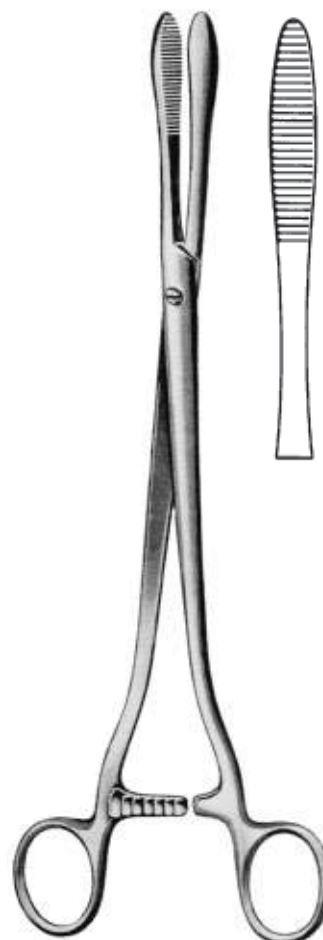

COLLIN
 AT 286.25
 250mm / 10"



CHERON
AT 290.25
250mm / 10"



BOZEMANN
AT 312.26
260mm / 10 1/4"

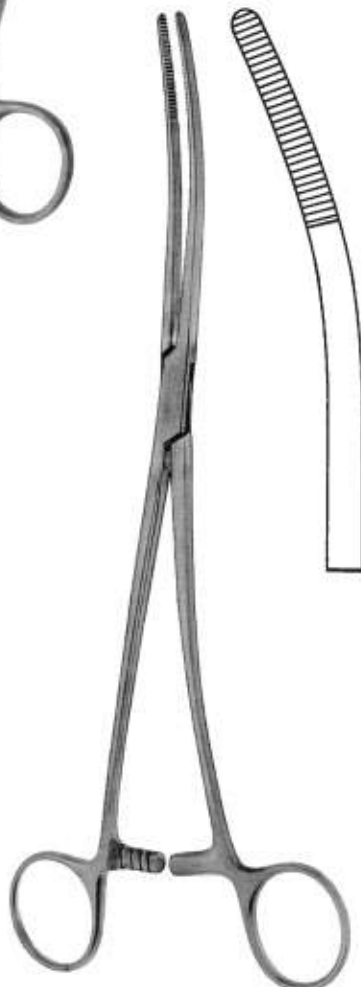

BOZEMANN
AT 313.26
260mm / 10 1/4"

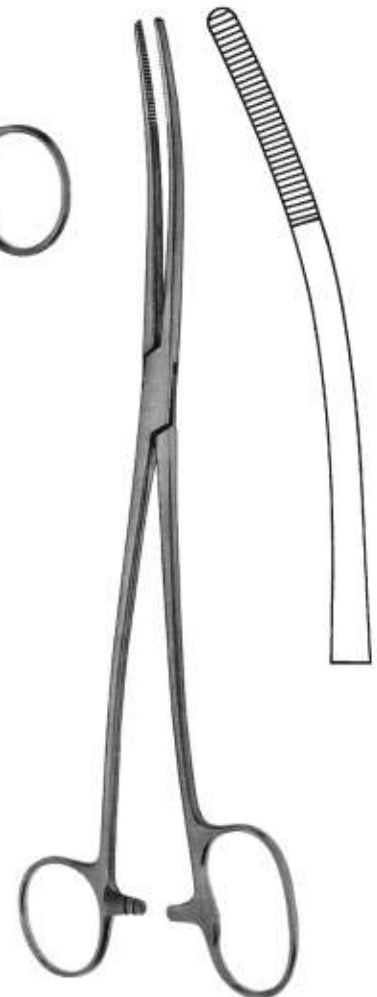

BOZEMANN - DOUGLAS
AT 315.26
260mm / 10 1/4"

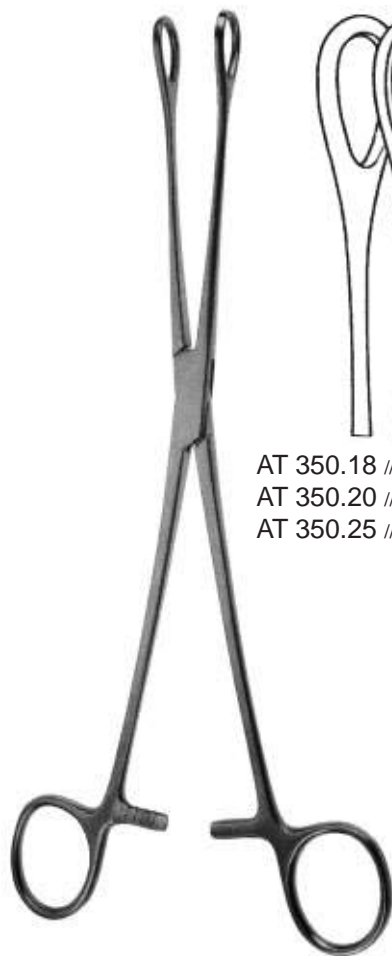

FOERSTER
AT 350.18 - AT 355.25



AT 350.18 // 180mm / 7"
 AT 350.20 // 200mm / 8"
 AT 350.25 // 250mm / 10"

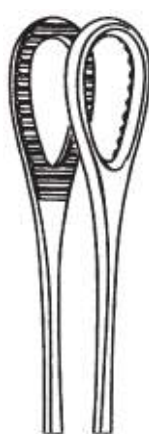

AT 352.18 // 180mm / 7"
 AT 352.20 // 200mm / 8"
 AT 352.25 // 250mm / 10"



AT 353.18 // 180mm / 7"
 AT 353.20 // 200mm / 8"
 AT 353.25 // 250mm / 10"

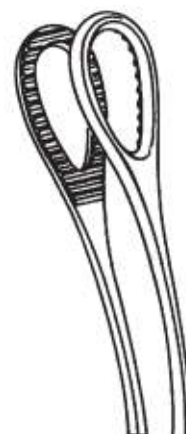

AT 355.18 // 180mm / 7"
 AT 355.20 // 200mm / 8"
 AT 355.25 // 250mm / 10"



FOERSTER
AT 360.25 - AT 361.25
 250mm / 10"



AT 360.25

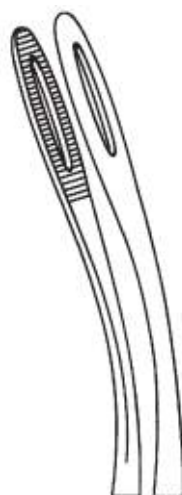

AT 361.25

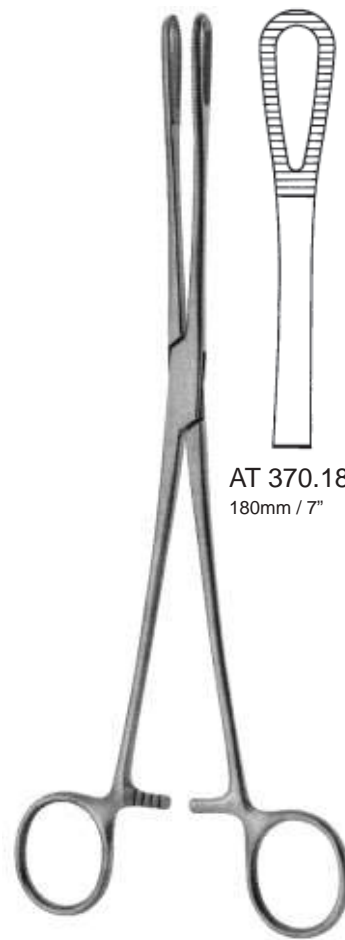

RAMPLEY
AT 370.18 - AT 370.25



AT 370.18
 180mm / 7"



AT 370.25
 250mm / 10"





**WUNDHAKEN, BAUCHDECKENHALTER
RETRACTORS, ABDOMINAL RETRACTORS
DIVARICATORI, DIVARICATORI ADDOMINALI
SEPARADORES, SEPARADORES ABDOMINALES**

Titan
 Titanium
 Titanio
 Titanio



Hauthäkchen
 Skin Hook
 Divaricatore per la pelle
 Gancho para piel

AD 001.18
 180mm / 7"



Knochenhäkchen
 Bone hook
 Divaricatore per osse
 Gancho para huesos

AD 006.01
 170mm / 6 3/4"



Sehnenhäkchen
 Tendon hook
 Divaricatore per tendini
 Gancho para tendón

AD 011.01
 170mm / 6 3/4"



AD 021.02



AD 021.03

AD 021.02 - AD 021.03
 160mm / 6 1/2"

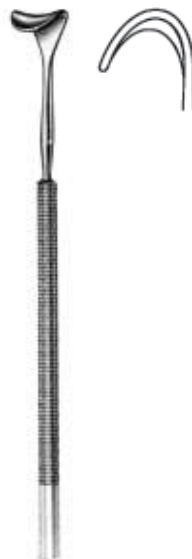

AD 030.12
 12mm



AD 030.14
 14mm



AD 030.16
 16mm

AD 030.12 - AD 030.16
 140mm / 5 1/2"

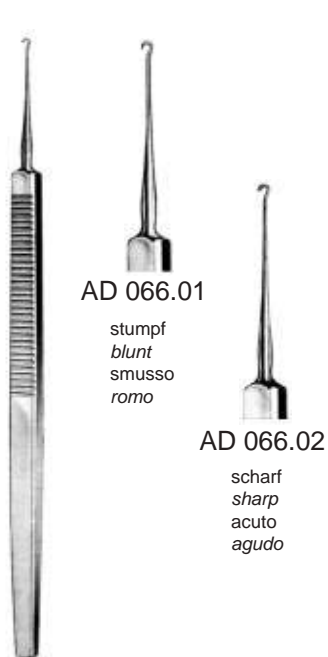

AD 066.01

stumpf
 blunt
 smusso
 romo

AD 066.02

scharf
 sharp
 acuto
 agudo

GRAEFE
 AD 066.01 - AD 066.02
 160mm / 6½"

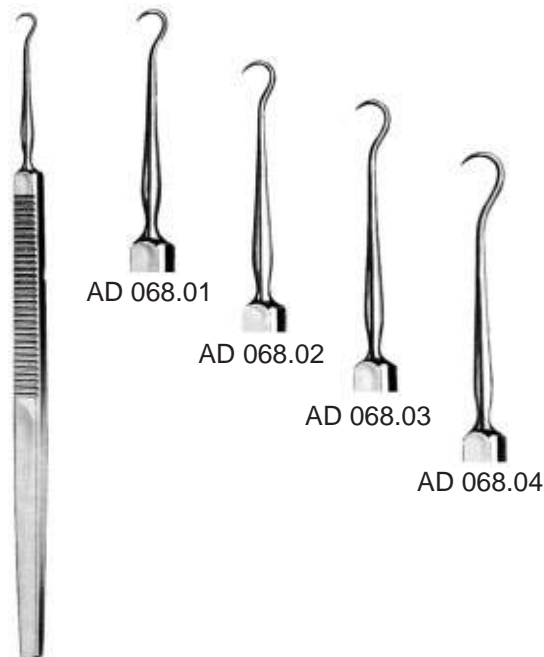

AD 068.01

AD 068.02

AD 068.03

AD 068.04

AD 068.01 - AD 068.04
 160mm / 6½"



O'CONNOR
 AD 070.16
 160mm / 6½"

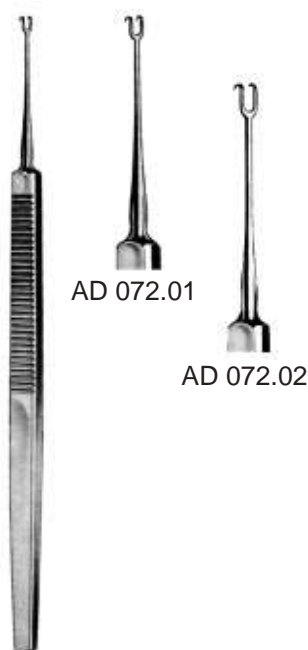

AD 072.01

AD 072.02

GUTHRIE
 AD 072.01 - AD 072.02
 160mm / 6½"

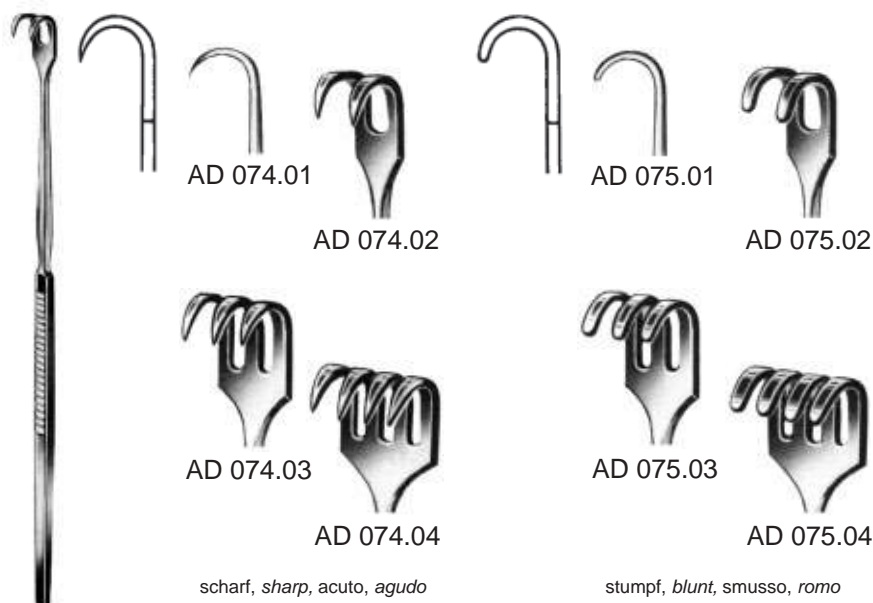

AD 074.01

AD 074.02

AD 075.01

AD 075.02

AD 074.03

AD 074.04

AD 075.03

AD 075.04

scharf, sharp, acuto, agudo

stumpf, blunt, smusso, romo

AD 074.01 - AD 075.04
 160mm / 6½"

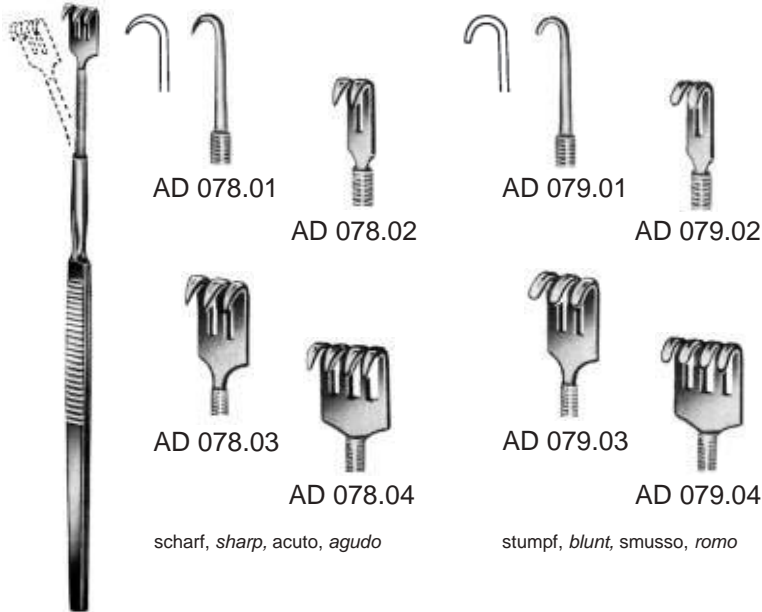

AD 078.01 - AD 079.04
160mm / 6½"
flexibel, flexible, flessibile, flexible

AD 086.04 - AD 087.04
160mm / 6½"

AD 088.12
120mm / 4¾"

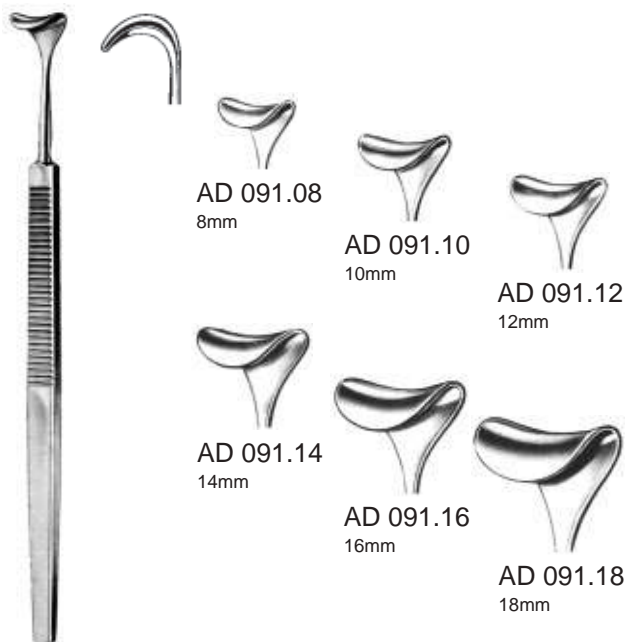

DESMARRES
AD 091.08 - AD 091.18
160mm / 6½"

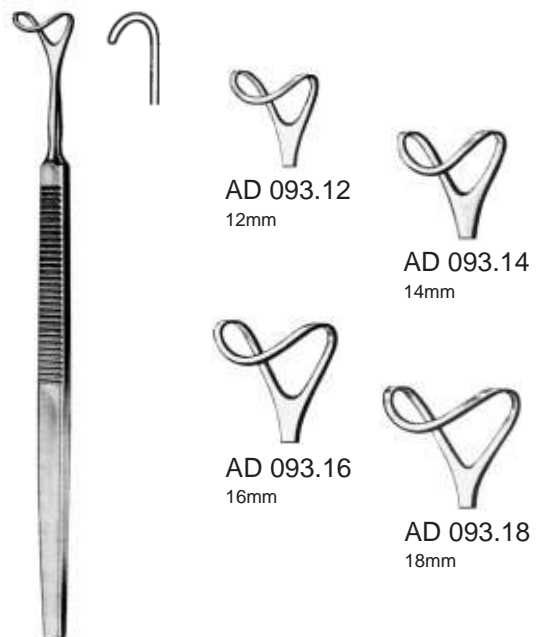

AD 093.12 - AD 093.18
160mm / 6½"



MINI - LANGENBECK
 AD 095.10 - AD 095.22
 160mm / 6½"



AD 099.16
 160mm / 6½"

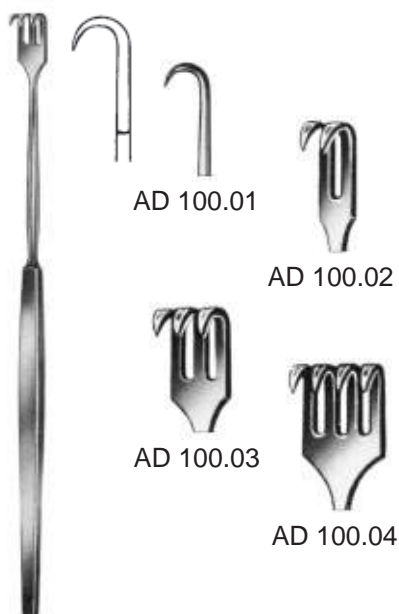

AD 100.01 - AD 100.04
 160mm / 6½"
 scharf, sharp, acuto, agudo

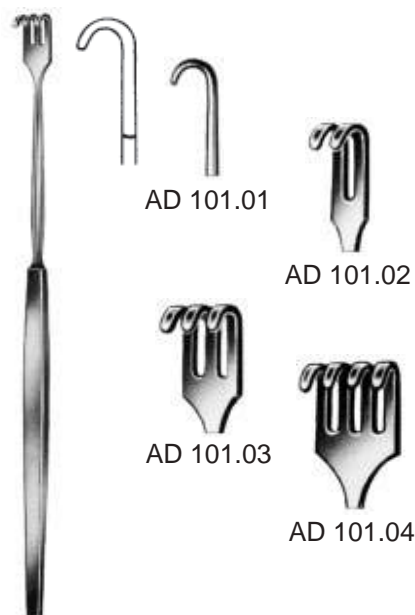

AD 101.01 - AD 101.04
 160mm / 6½"
 stumpf, blunt, smusso, romo

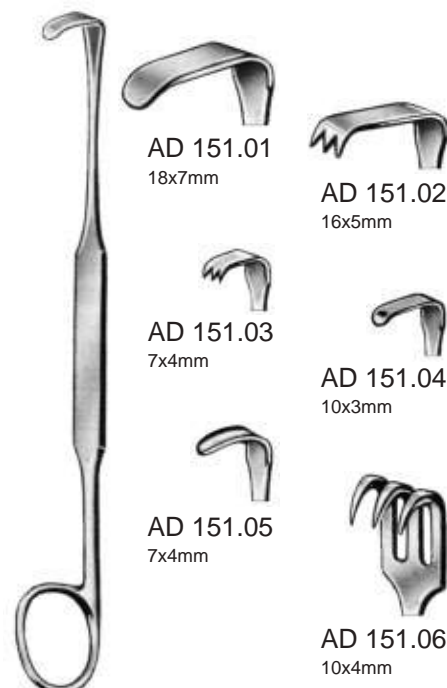

MEYERDING
 AD 151.01 - AD 151.06
 180mm / 7"



AD 161.01
 20x6mm

AD 161.02
 10x6mm

SENN - GREEN
 AD 161.01 - AD 161.02
 150mm / 6"



8x4mm

15x5,5mm

RAGNELL - DAVIS
 AD 164.14
 140mm / 5½"

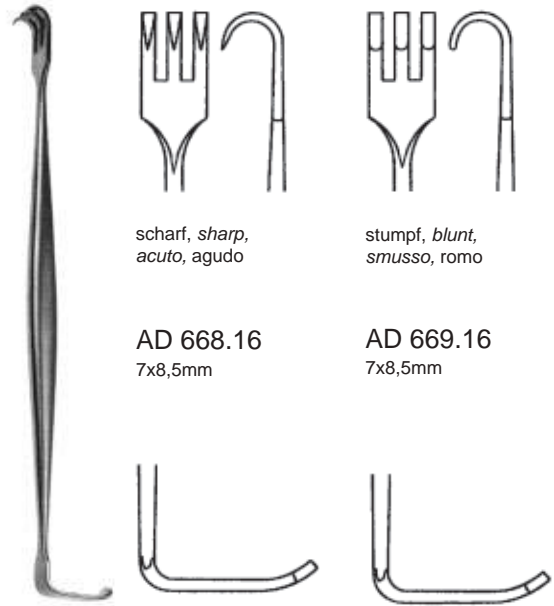

scharf, *sharp,*
acuto, agudo

stumpf, *blunt,*
smusso, romo

AD 668.16
 7x8,5mm

AD 669.16
 7x8,5mm

SENN - MUELLER
 AD 668.16 - AD 669.16
 140mm / 5½"

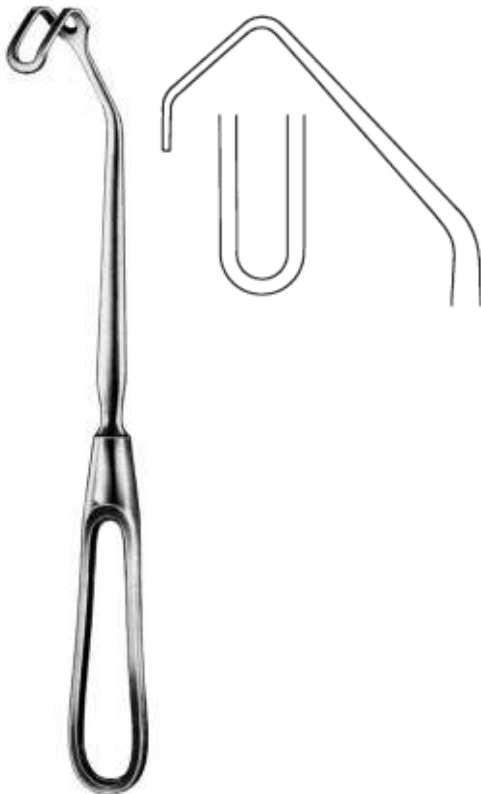

CUSHING
 AD 170.20
 200mm / 8"

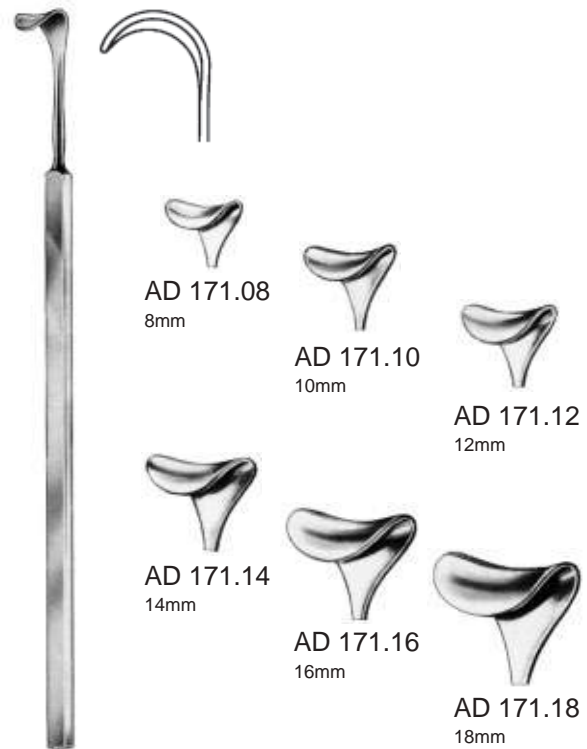

AD 171.08
 8mm

AD 171.10
 10mm

AD 171.12
 12mm

AD 171.14
 14mm

AD 171.16
 16mm

AD 171.18
 18mm

CUSHING
 AD 171.08 - AD 171.18
 200mm / 8"

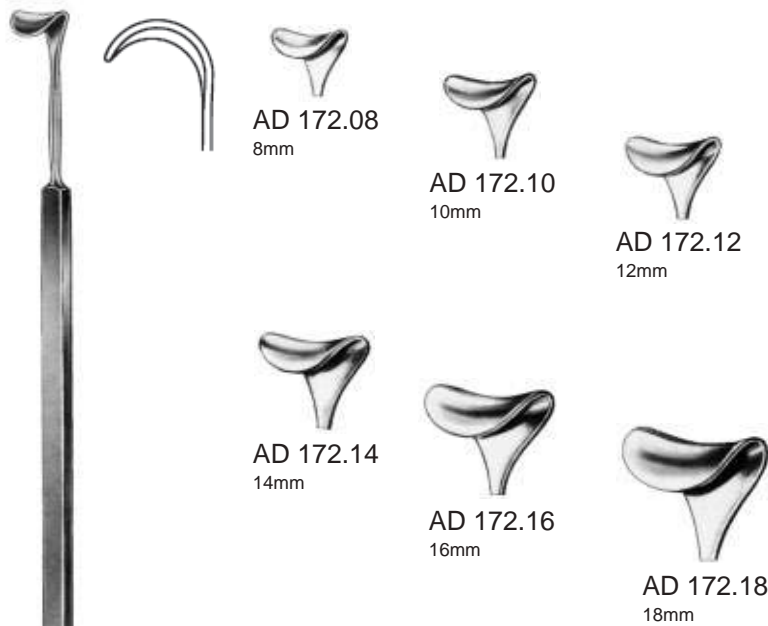

CUSHING
 AD 172.08 - AD 172.18
 240mm / 9½"

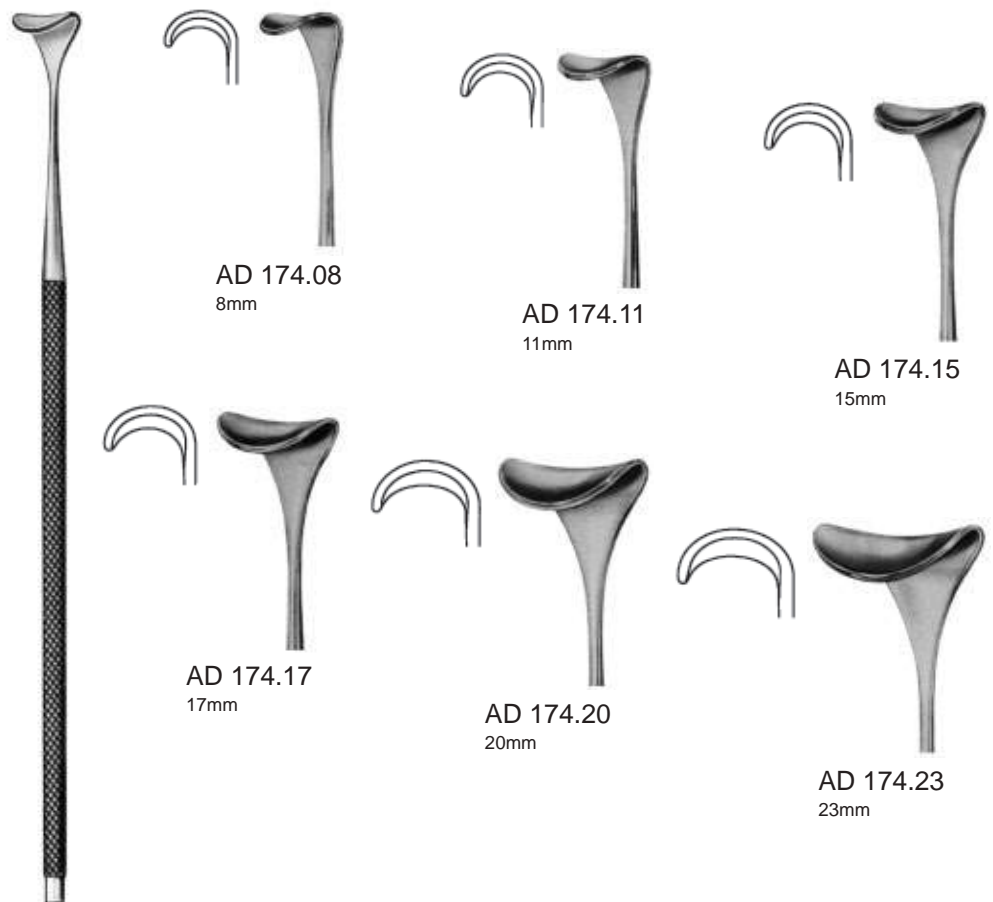

GIL - VERNET
 AD 174.08 - AD 174.23
 240mm / 9½"
 biegsam, malleable, malleabile, maleable



AD 176.01



AD 176.02

VENENHAKEN BROM
 AD 176.01 - AD 176.02
 190mm / 7½"



AD 191.01



AD 191.02

STRANDELL - STILLE
 AD 191.01 - AD 191.02
 190mm / 7½"



KILNER
 AD 203.15
 150mm / 6"



AD 207.18



AD 209.18

GILLIES
 AD 207.18 - AD 209.18
 180mm / 7"



scharf
 sharp
 acuto
 agudo

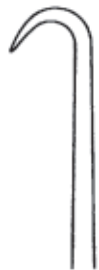

AD 210.01



AD 210.02



AD 210.03



AD 210.04

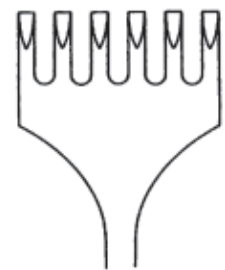

AD 210.06

stumpf
 blunt
 smusso
 romo



AD 211.01



AD 211.02



AD 211.03



AD 211.04

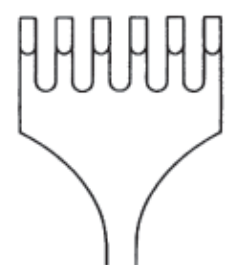

AD 211.06

VOLKMANN
 AD 210.01 - AD 211.06
 220mm / 8¾"



scharf
 sharp
 acuto
 agudo



AD 220.01



AD 220.02



AD 220.03



AD 220.04

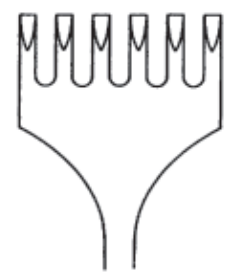

AD 220.06

stumpf
 blunt
 smusso
 romo



AD 221.01



AD 221.02



AD 221.03



AD 221.04

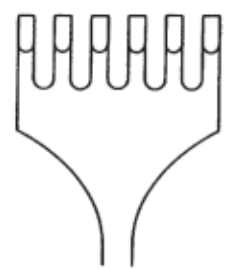

AD 221.06

VOLKMANN
 AD 220.01 - AD 221.06

220mm / 8 3/4"



scharf
 sharp
 acuto
 agudo



AD 240.01



AD 240.02



AD 240.03



AD 240.04



AD 240.06



AD 240.08

stumpf
 blunt
 smusso
 romo



AD 241.01



AD 241.02



AD 241.03



AD 241.04



AD 241.06



AD 241.08

KOCHER
 AD 240.01 - AD 241.08

220mm / 8 3/4"

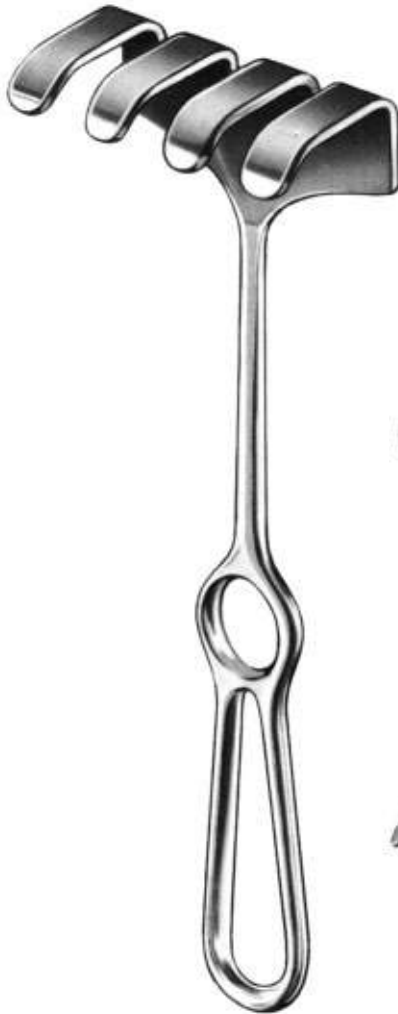

OLLIER
 AD 251.03 - AD 253.04
 240mm / 9½"



AD 251.03
 36x30mm



AD 253.04
 36x60mm



33x20mm

WASSMUND
 AD 261.02
 200mm / 8"



KOERTE
 AD 266.08 - AD 267.08
 230mm / 9"



AD 266.08
 40x26mm

scharf
 sharp
 acuto
 agudo



AD 267.08
 40x26mm

stumpf
 blunt
 smusso
 romo



ISRAEL
AD 281.04 - AD 289.07
250mm / 10"



AD 281.04
40x40mm



AD 283.05
45x50mm



AD 287.06
50x60mm



AD 289.07
70x70mm

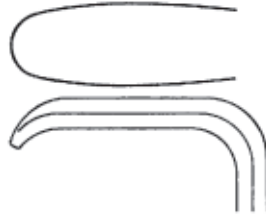

AD 291.01
 AD 293.01
 30x11mm



AD 291.02
 AD 293.02
 30x14mm



AD 291.03
 AD 293.03
 30x16mm

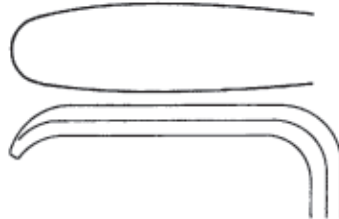

AD 291.04
 AD 293.04
 40x11mm

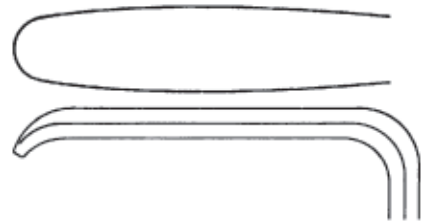

AD 291.05
 AD 293.05
 50x11mm

LANGENBECK
 AD 291.01 - AD 291.05
 220mm / 8³/₄"

LANGENBECK
 AD 293.01 - AD 293.05
 220mm / 8³/₄"

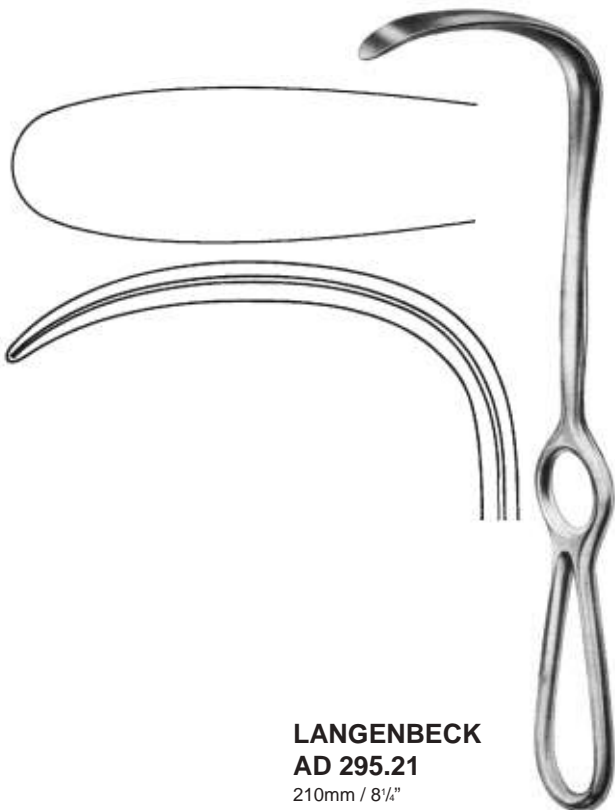

LANGENBECK
 AD 295.21
 210mm / 8¹/₄"

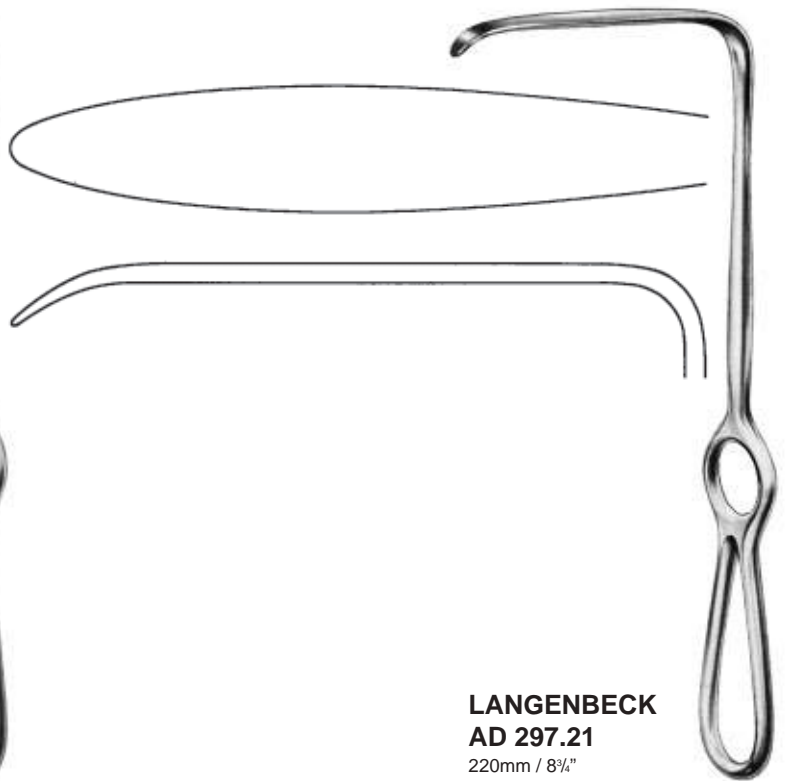

LANGENBECK
 AD 297.21
 220mm / 8³/₄"

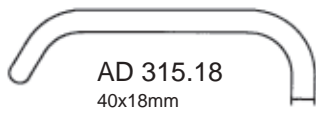

AD 315.18
 40x18mm

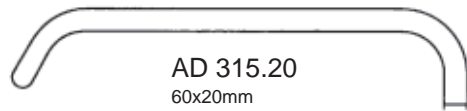

AD 315.20
 60x20mm

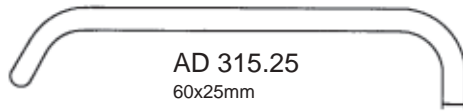

AD 315.25
 60x25mm

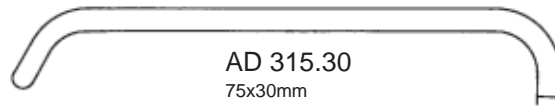

AD 315.30
 75x30mm

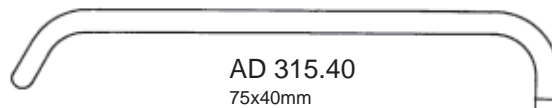

AD 315.40
 75x40mm

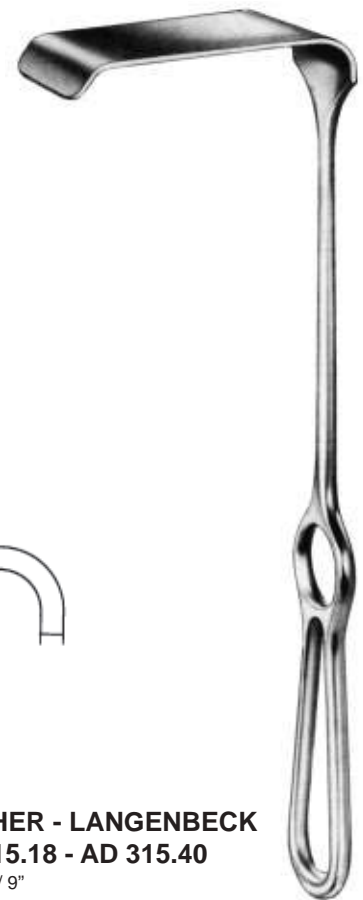

LANGENBECK BERNHARD, * 1859, † 1887

Deutscher Chirurg. Mitbegründer der modernen Chirurgie und der Kriegschirurgie.
 German Surgeon. One of the founders of the modern surgery and war-time surgery.
 Chirurgo tedesco. Cofondatore della chirurgia moderna e della chirurgia della guerra.
 Cirujano alemán. Uno de los fundadores de la cirugía moderna y de la cirugía de guerra.

KOCHER - LANGENBECK
AD 315.18 - AD 315.40
 230mm / 9"

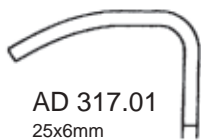

AD 317.01
 25x6mm

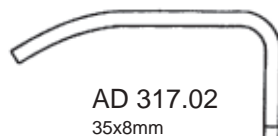

AD 317.02
 35x8mm

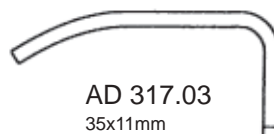

AD 317.03
 35x11mm

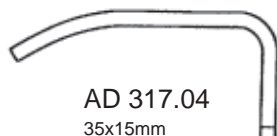

AD 317.04
 35x15mm

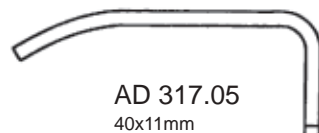

AD 317.05
 40x11mm

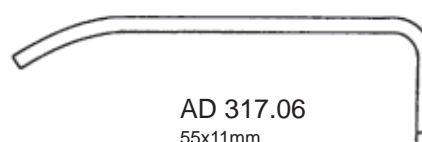

AD 317.06
 55x11mm



AD 317.07
 70x14mm



AD 317.08
 80x12mm



AD 317.09
 80x16mm

KOCHER - LANGENBECK
AD 317.01 - AD 317.09
 220mm / 8 1/2"





ZENKER
AD 321.01 - AD 321.05



AD 321.01
230mm / 9"
35x8mm

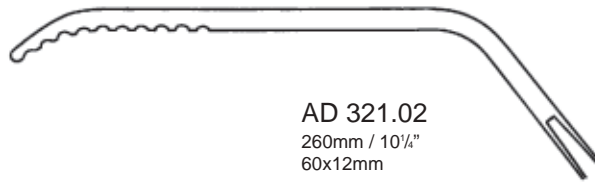

AD 321.02
260mm / 10 1/4"
60x12mm

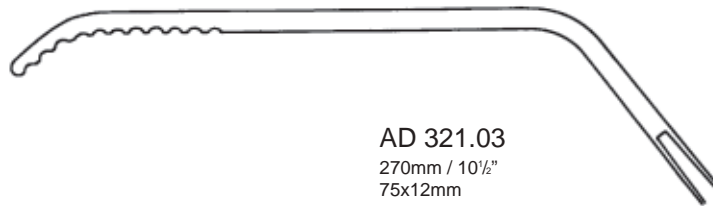

AD 321.03
270mm / 10 1/2"
75x12mm



AD 321.04
290mm / 11 1/4"
85x20mm

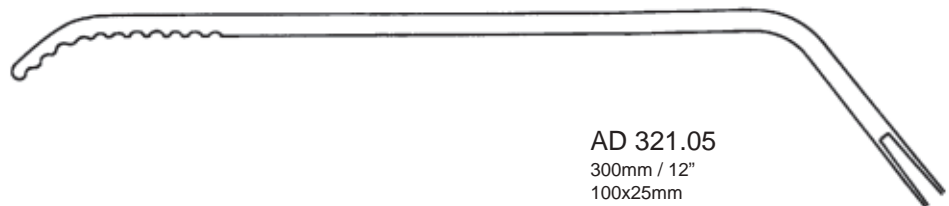

AD 321.05
300mm / 12"
100x25mm

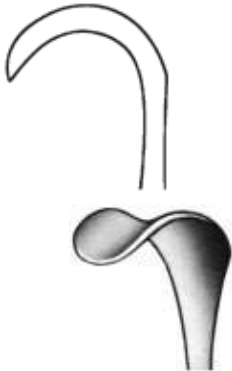

AD 325.01
 19x12mm



AD 325.02
 21x14mm

KOCHER
 AD 325.01 - AD 325.02
 200mm / 8"

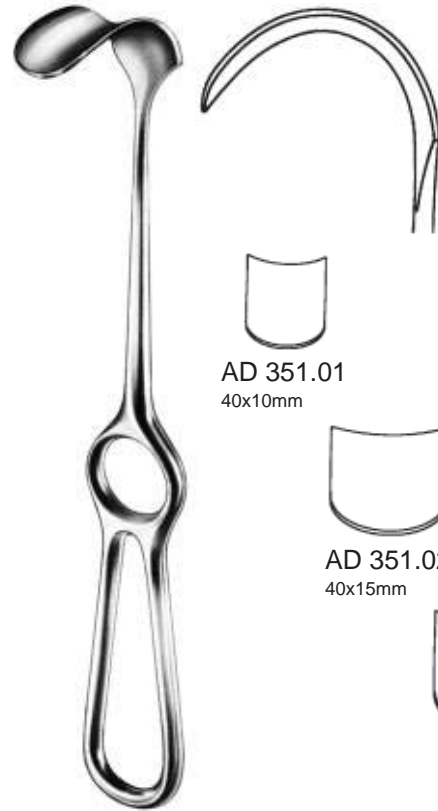

AD 351.01
 40x10mm



AD 351.02
 40x15mm



AD 351.03
 40x20mm

KOCHER
 AD 351.01 - AD 351.03
 220mm / 8 1/2"



AD 360.01
 AD 361.01
 210mm / 8 1/4"
 14x17mm



AD 360.02
 AD 361.02
 220mm / 8 1/2"
 20x22mm



AD 360.03
 AD 361.03
 230mm / 9"
 26x30mm

MIDDELDORPF
 AD 360.01 - AD 360.03



MIDDELDORPF
 AD 361.01 - AD 361.03

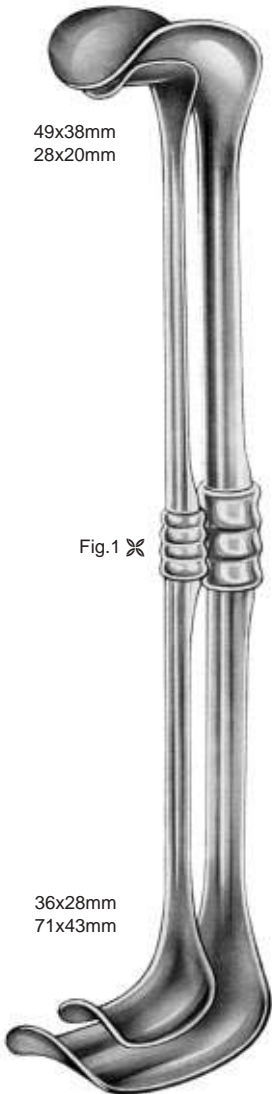

49x38mm
 28x20mm

Fig.1 ✂ ©Fig.2

36x28mm
 71x43mm

RICHARDSON - EASTMANN

AD 381.00 // Fig.1+Fig.2 // Satz, Set, Serie, Juego

AD 381.01 // Fig.1 // 260mm / 10¹/₄"

AD 381.02 // Fig.2 // 280mm / 11"



52x22mm

RICHARDSON
AD 395.24

240mm / 9¹/₂"



AD 391.01
 28x20mm



AD 391.02
 30x28mm



AD 391.03
 38x37mm

RICHARDSON
AD 391.01 - AD 391.03
 240mm / 9¹/₂"



65x50mm

KELLY
AD 397.26
 260mm / 10¹/₄"

DOYEN EUGEN JOSEF, * 1859

Geboren in Reims. Spezialist in der abdominalen Chirurgie.
Born in Reims. Specialist in abdominal surgery.
Nato a Reims. Specialista in Chirurgia addominale.
Nacido en Reims. Especialista en cirugía abdominal.

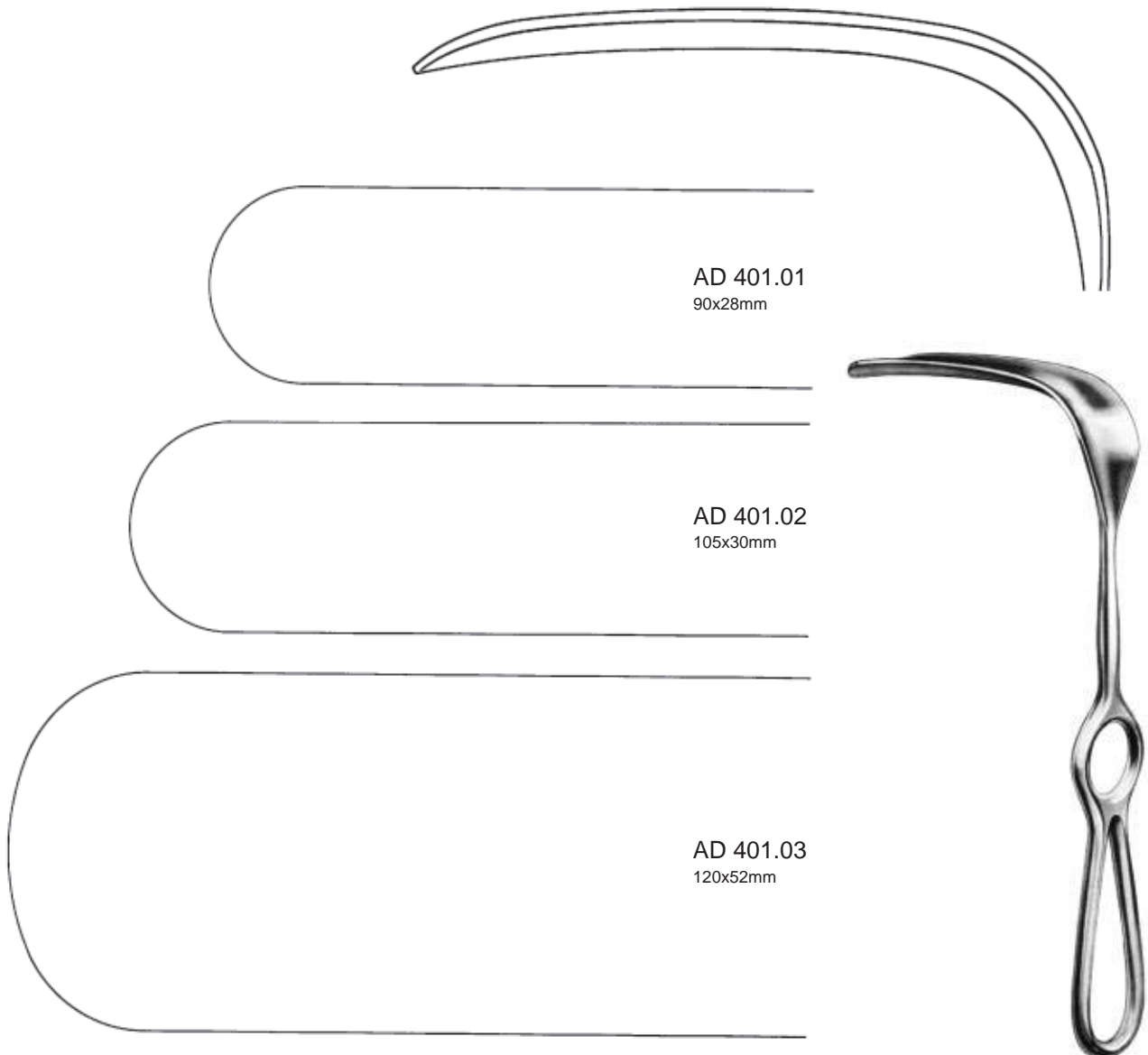

DOYEN - STILLE
AD 401.01 - AD 401.03
250mm / 10"



AD 405.01
60x20mm



AD 405.02
80x30mm



AD 405.03
100x30mm



AD 405.04
120x30mm



AD 405.05
140x30mm



AD 405.06
140x40mm



HÖSEL
AD 405.01 - AD 405.06
260mm / 10 1/4"



MIDDELDORPF
 AD 441.01 - AD 441.03
 270mm / 10½"



AD 441.01
 45x45mm



AD 441.02
 45x50mm



AD 441.03
 55x70mm



FRITSCH
 AD 452.00 - AD 452.05
 230mm / 9"

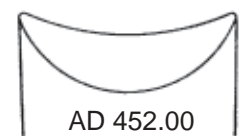
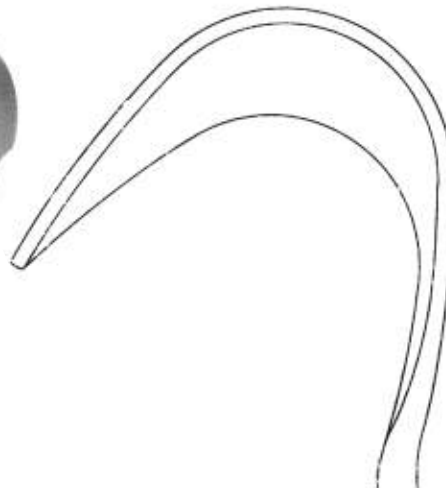

AD 452.00
 30x30mm



AD 452.01
 32x40mm



AD 452.02
 40x50mm

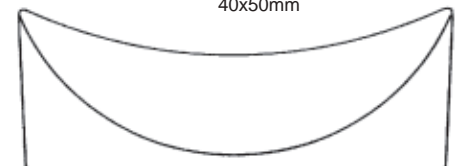

AD 452.03
 40x60mm



AD 452.04
 45x75mm

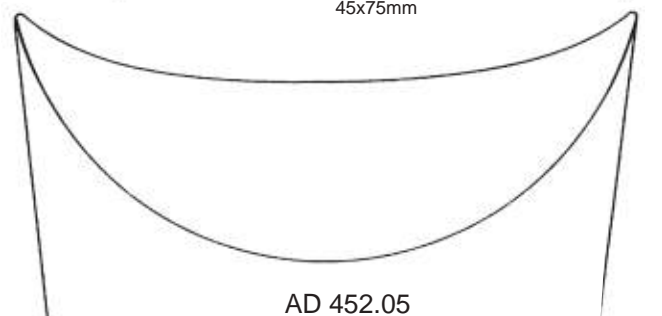

AD 452.05
 65x85mm

FRITSCH HEINRICH, * 1844, † 1915

Geboren in Breslau, gestorben in Bonn. Gynäkologe.
 Besondere Abdrucktechnik bei der Blutung Post-partum.
 Born in Breslau, died in Bonn. Gynecologist.

Particular compression technique for bleeding in post partum.

Nato a Breslavia, morto a Bonn. Ginecologo. Tecnica particolare in caso di emorragia Post-partum.

Nacido en Breslavia, muerto en Bonn. Ginecólogo. Técnica particular en caso de hemorragia Post-partum.

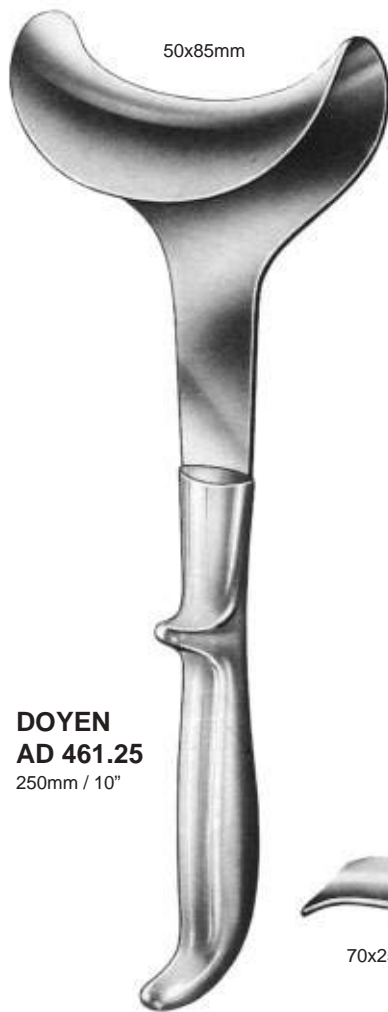

115x22mm
115x27mm

95x20mm

105x27mm

SIMON
AD 505.28 // 115x22mm
AD 507.28 // 115x27mm
280mm / 11"

MODELL TÜBINGEN
AD 503.28
280mm / 11"

MARTIN
AD 501.25
260mm / 10¹/₄"



AD 537.01
82x22mm



AD 537.02
115x38mm



AD 537.03
115x65mm



CORYLLOS
AD 537.01 - AD 537.03
230mm / 9"



75x50mm

DAVIDSON
AD 545.01
160mm / 6½"



75x90mm

DAVIDSON
AD 545.02
160mm / 6½"



SAUERBRUCH
AD 551.25
250mm / 10"

BRUNNER
AD 557.74
240mm / 9½"

AD 558.18 // 180x30mm

AD 558.16 // 160x30mm

AD 558.14 // 140x30mm

AD 558.13 // 130x30mm

AD 558.12 // 120x25mm

AD 558.10 // 100x25mm

AD 558.08 // 80x20mm



BRUNNER
AD 558.08 - AD 558.18
250mm / 10"

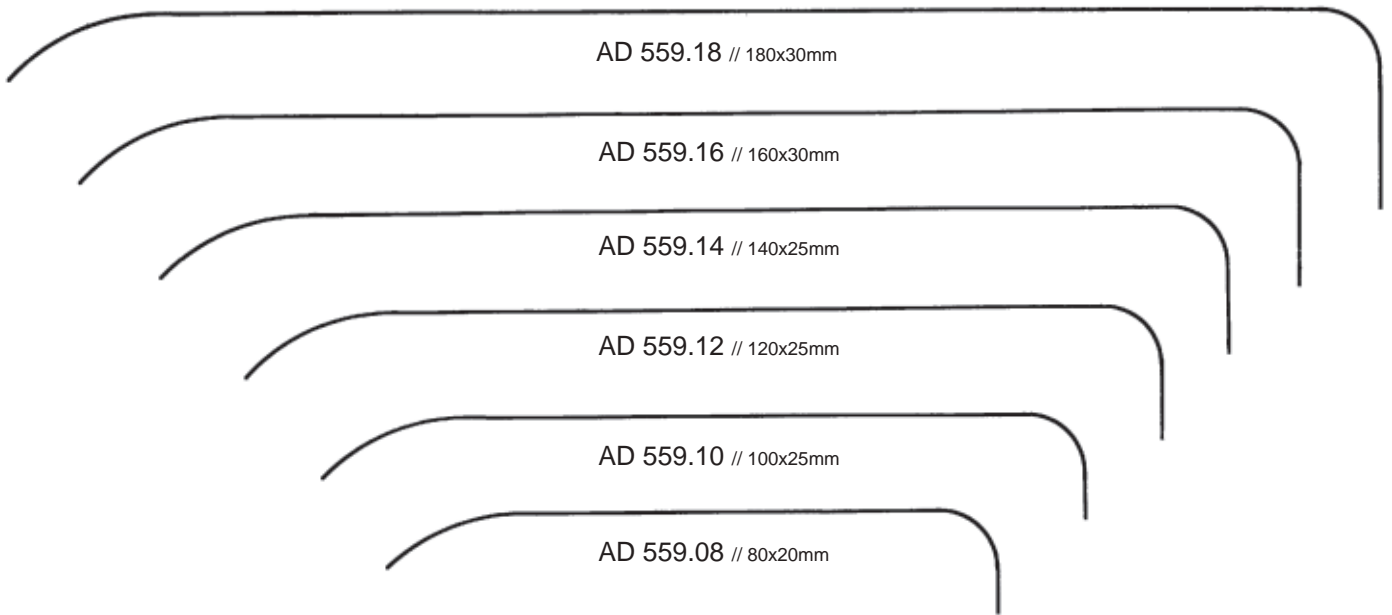

AD 559.18 // 180x30mm

AD 559.16 // 160x30mm

AD 559.14 // 140x25mm

AD 559.12 // 120x25mm

AD 559.10 // 100x25mm

AD 559.08 // 80x20mm



BRUNNER
AD 559.08 - AD 559.18
250mm / 10"

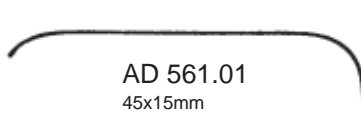

AD 561.01
45x15mm

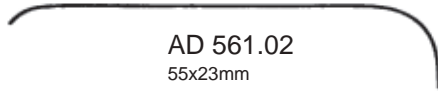

AD 561.02
55x23mm



AD 561.03
72x20mm



SAUERBRUCH
 AD 561.01 - AD 561.03
 230mm / 9"

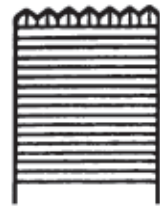

AD 562.01
15x15mm



AD 562.02
15x23mm

CRAWFOORD
 AD 562.01 - AD 562.02
 190mm / 7½"



ROSS
 AD 563.01 - AD 563.06
 250mm / 10"



AD 563.01
13x13mm



AD 563.02
14x12mm



AD 563.03
18x18mm



AD 563.04
20x20mm



AD 563.05
22x18mm



AD 563.06
26x24mm

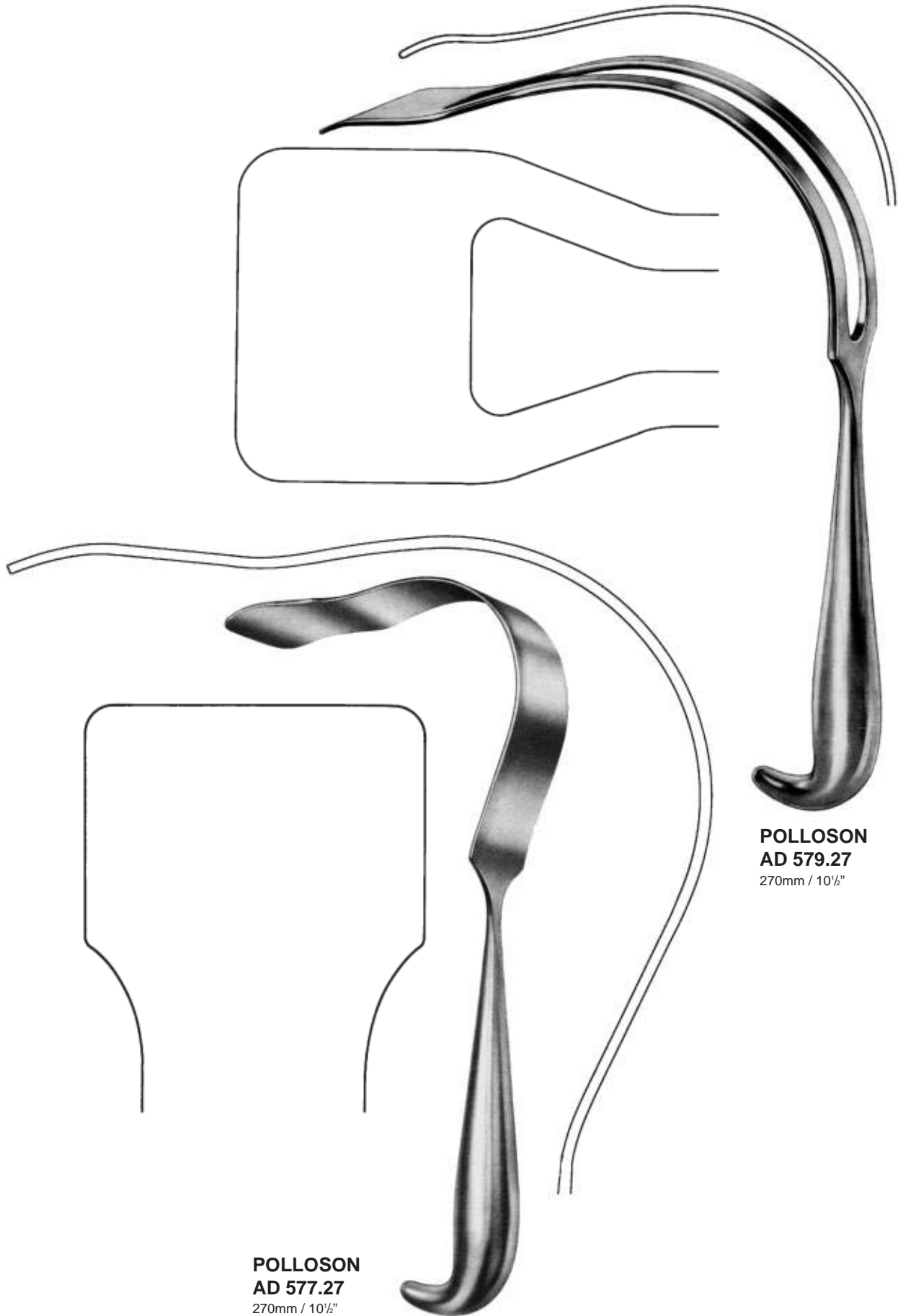

POLLOSON
AD 579.27
270mm / 10½"

POLLOSON
AD 577.27
270mm / 10½"

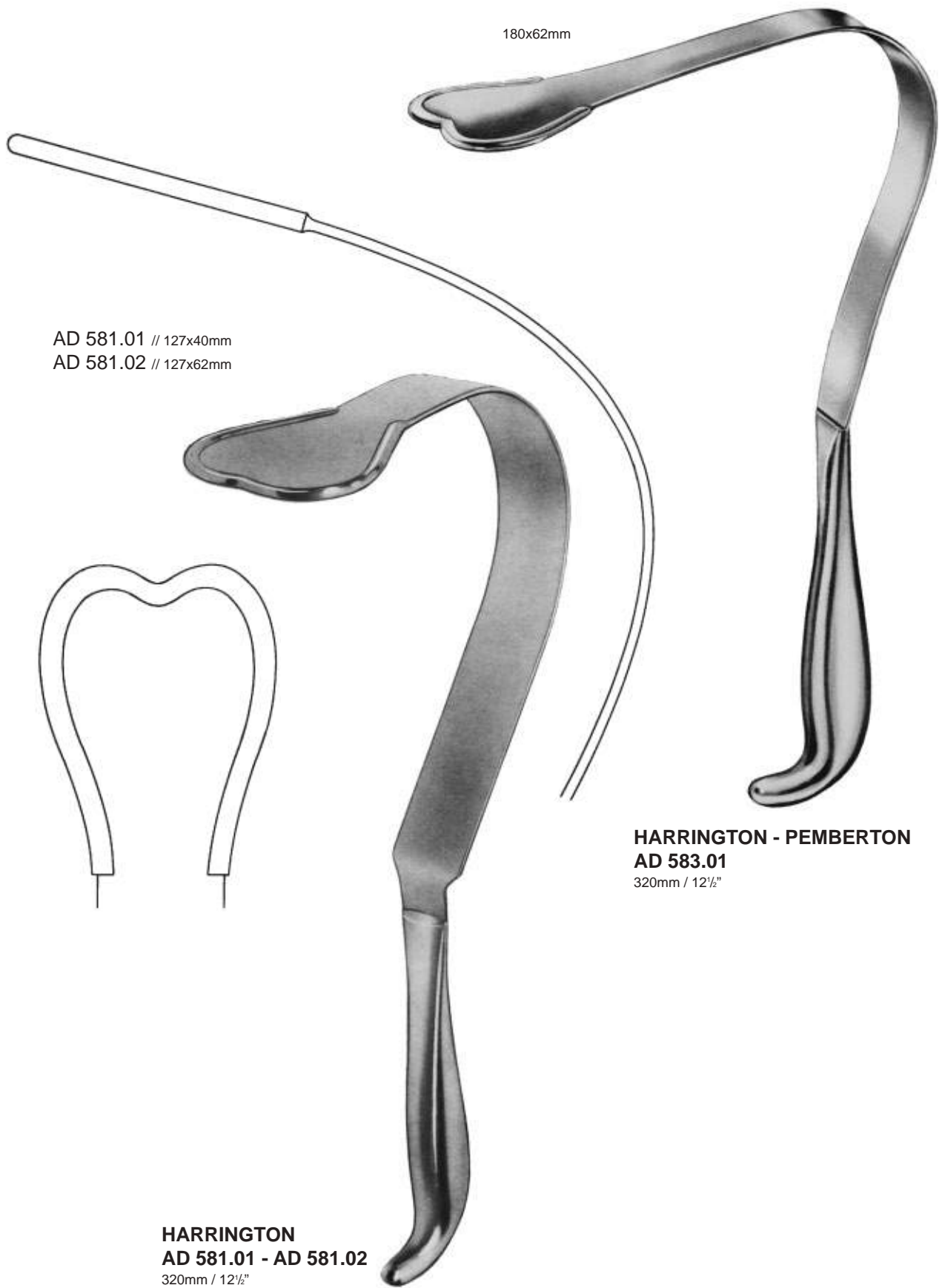





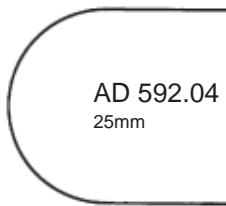

AD 592.04
 25mm



AD 592.07
 38mm



AD 592.08
 50mm

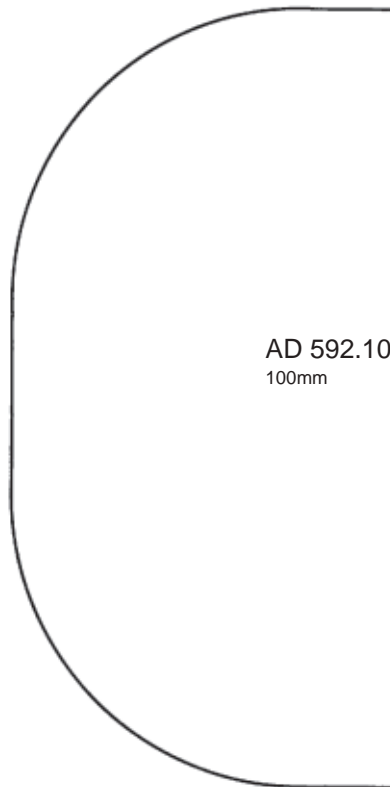

AD 592.10
 100mm



DEAVER
AD 592.04 - AD 592.10
 310mm / 12 1/4"



COOLEY
AD 593.01 - AD 593.03

rechts
right
 destra
 a derecha

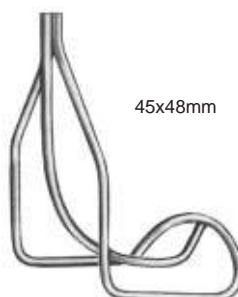

AD 593.01
 210mm / 8 1/4"

rechts, mit Zahnriefen
right, serrated
 destra, con zigrinatura
 a derecha, estriado

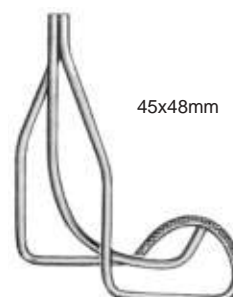

AD 593.02
 210mm / 8 1/4"

links
left
 sinistra
 a izquierda

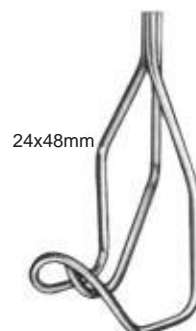

AD 593.03
 230mm / 9"



KELLY
AD 610.01 // 160x38mm
AD 610.02 // 160x57mm

AD 611.01 // 190x38mm
AD 611.02 // 190x57mm
270mm / 10 1/2"

MIKULICZ
AD 607.26
260mm / 10 1/4"

MIKULICZ
AD 603.01 - AD 603.03
250mm / 10"

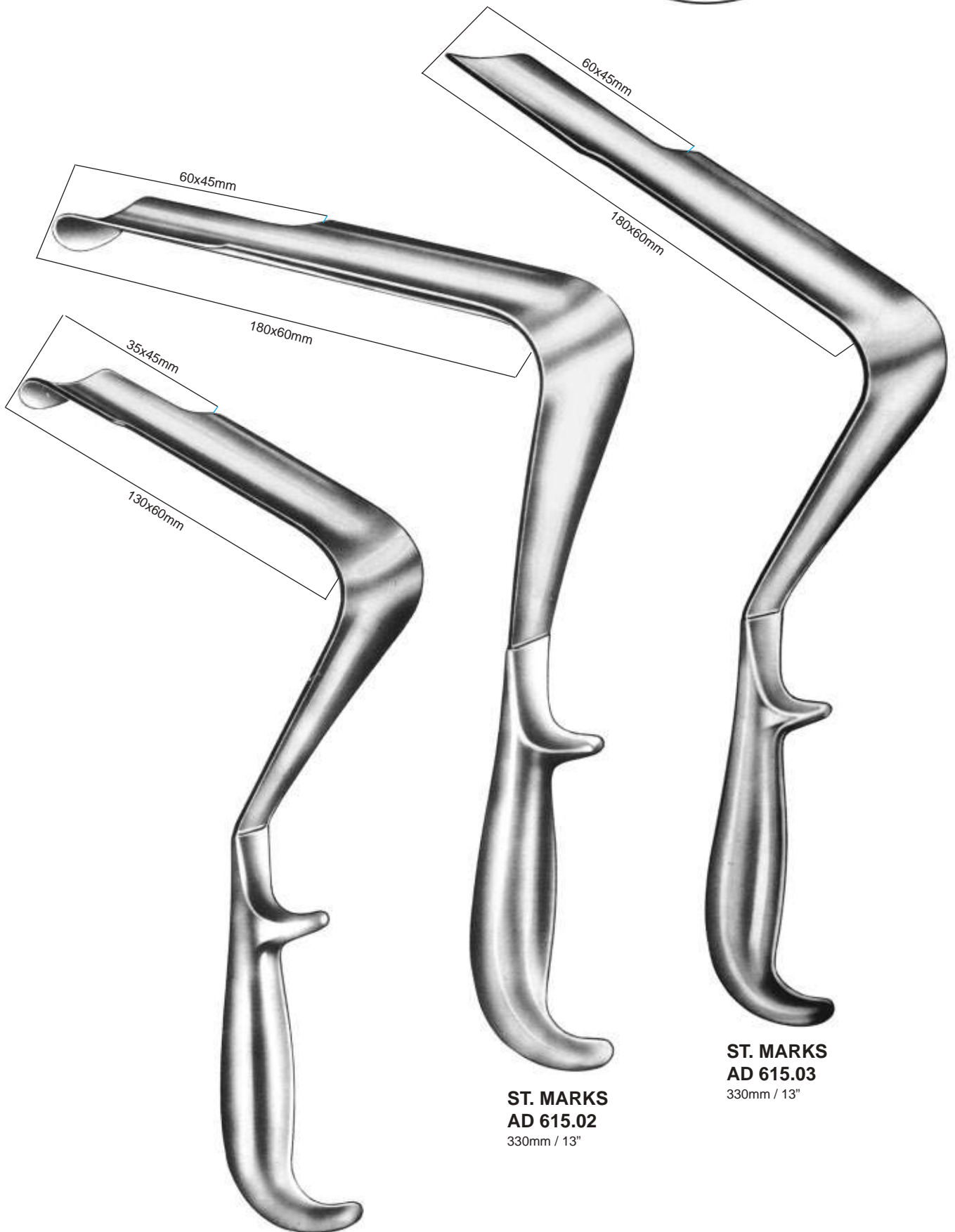

**ST. MARKS
AD 615.01**
290mm / 11¼"

**ST. MARKS
AD 615.02**
330mm / 13"

**ST. MARKS
AD 615.03**
330mm / 13"

Pelvishaken, *Pelvis Retractors,*
Divaricatori per pelvis, *Separadores para pelvis*

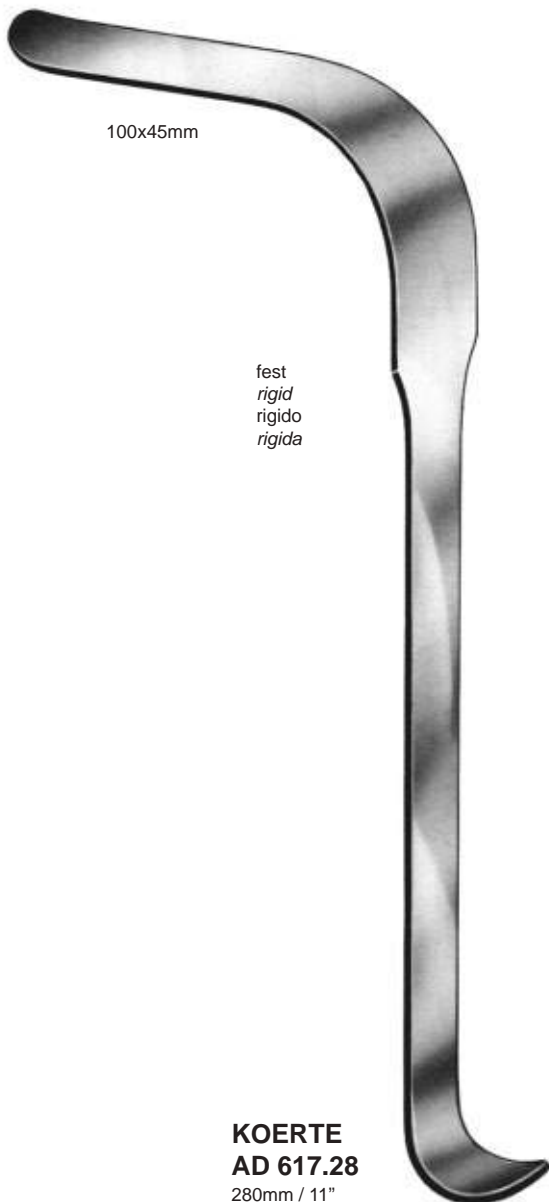

KOERTE
AD 617.28
280mm / 11"

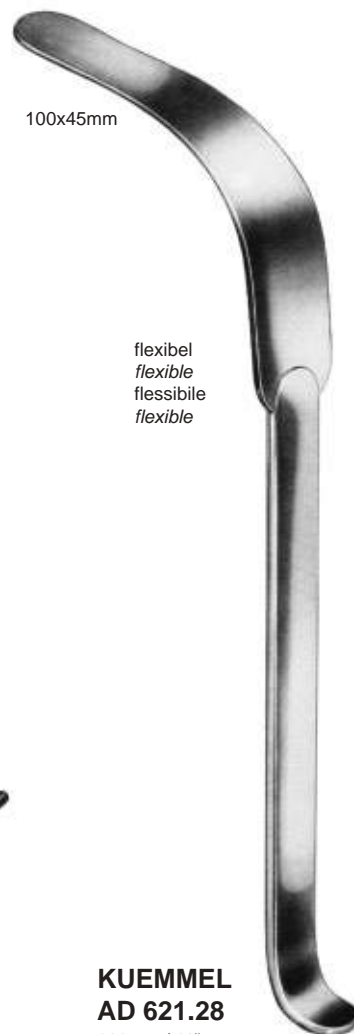

KUEMMEL
AD 621.28
280mm / 11"

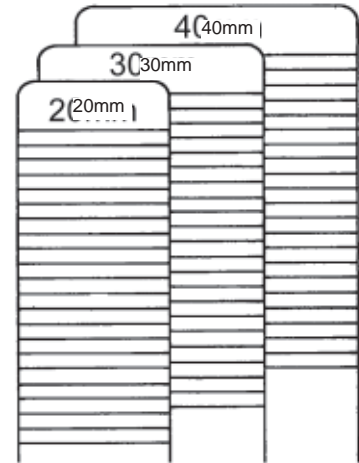

KADER
AD 623.20 // 20mm
AD 623.30 // 30mm
AD 623.40 // 40mm
270mm / 10½"

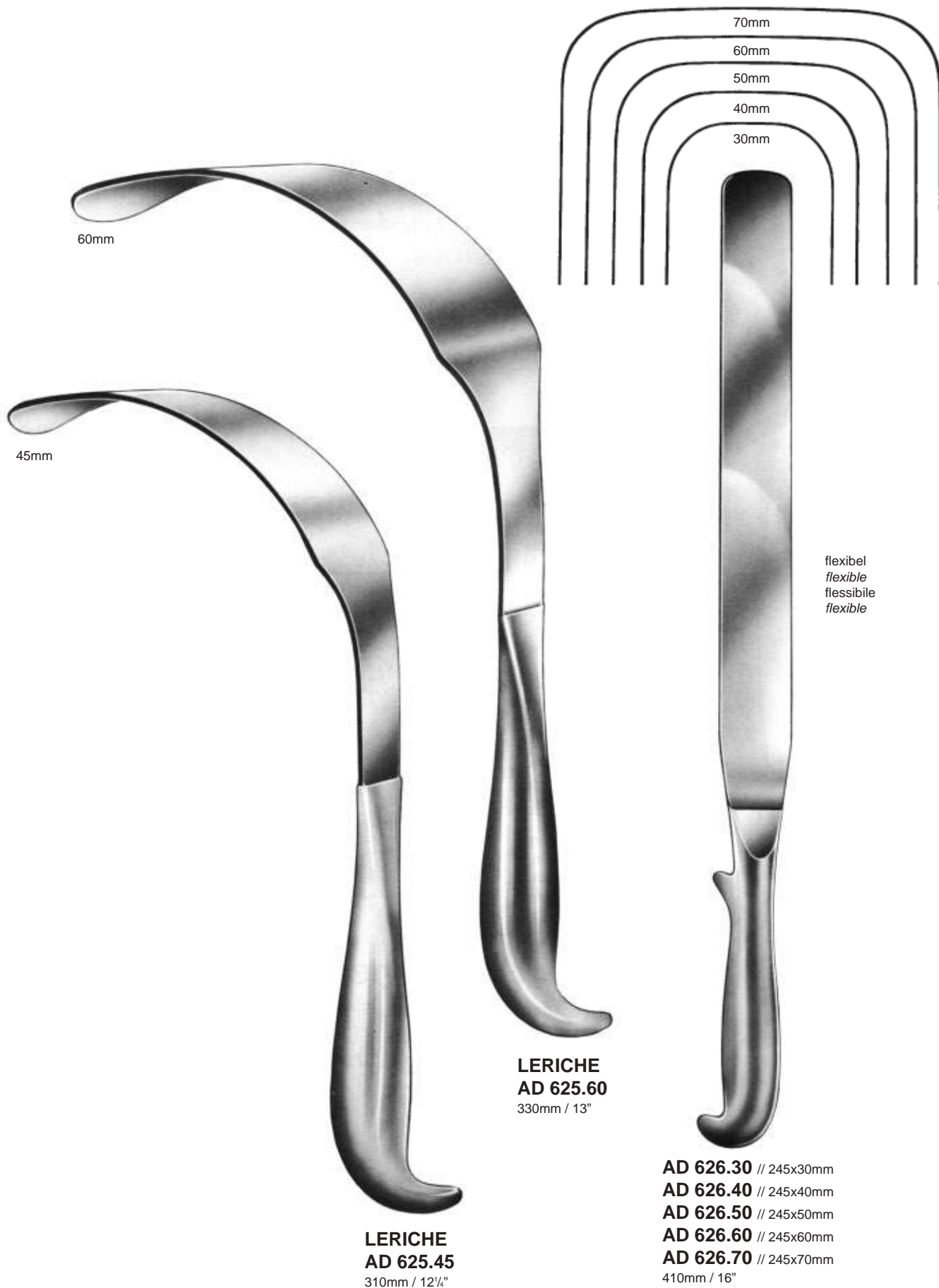

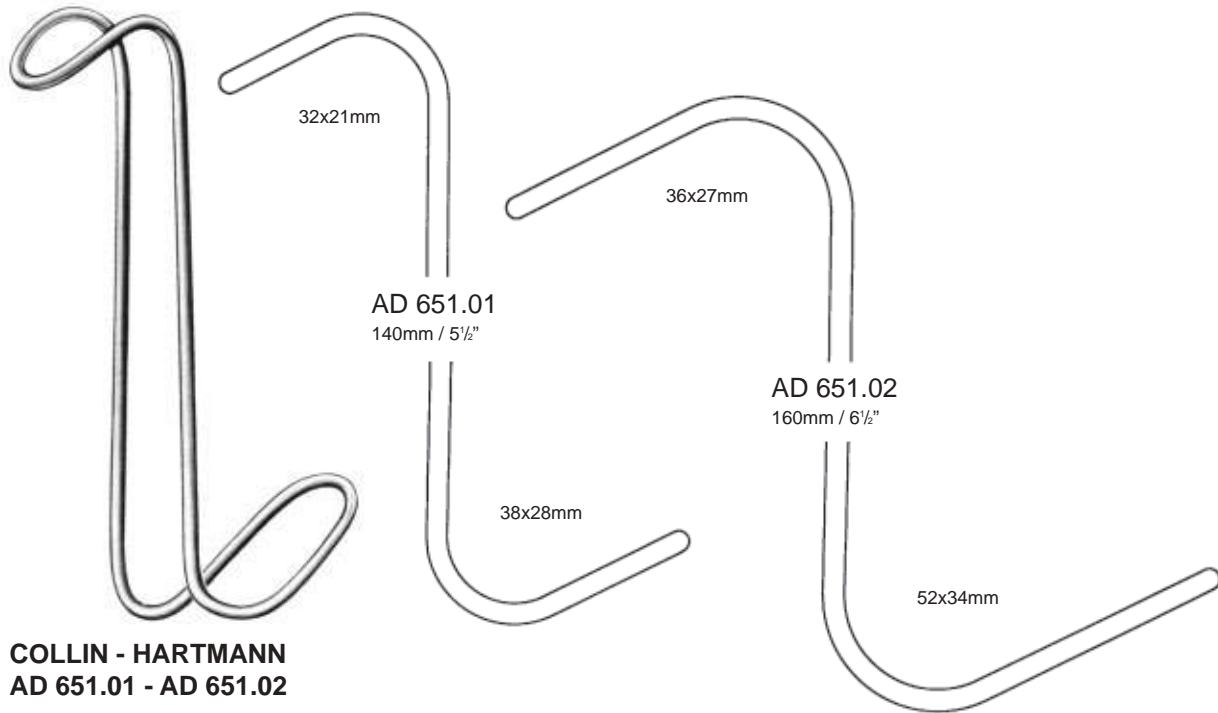

COLLIN - HARTMANN
AD 651.01 - AD 651.02

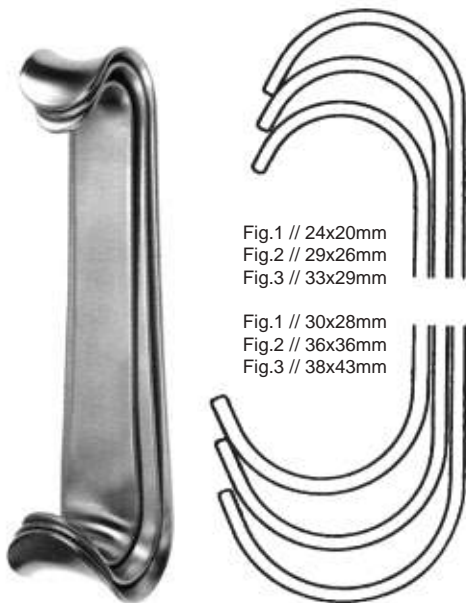

ROUX
AD 655.00 // Satz, Set, Serie, Juego
AD 655.01 // Fig.1 // 150mm / 6"
AD 655.02 // Fig.2 // 160mm / 6 1/2"
AD 655.03 // Fig.3 // 170mm / 6 3/4"

FARABEUF LUIS ALBERT, * 1841, † 1910

Professor der Anatomie der medizinischen Fakultät in Paris.
Professor of Anatomy Medical Faculty in Paris.
Professore di anatomia alla Facoltà di Medicina di Parigi.
Profesor de anatomía en la Facultad de Medicina de París.

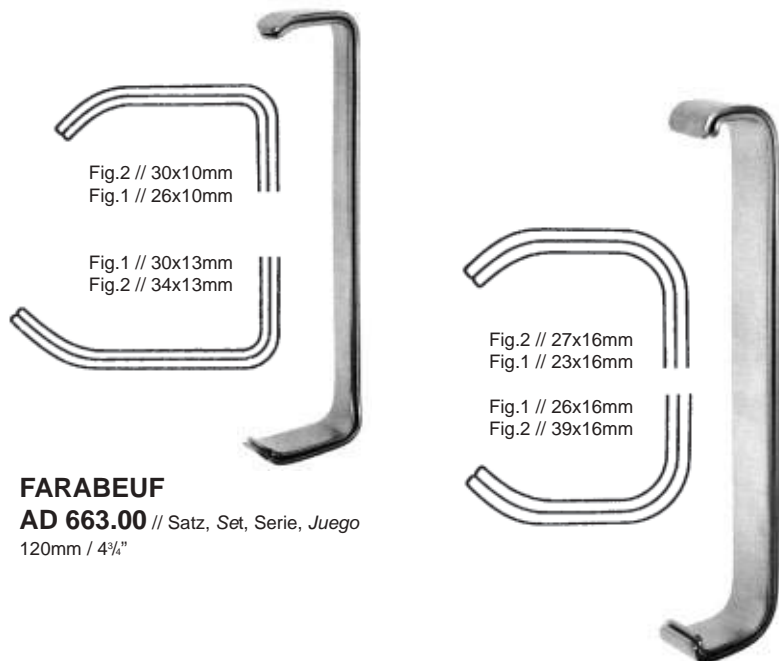

FARABEUF
AD 663.00 // Satz, Set, Serie, Juego
120mm / 4 3/4"

FARABEUF
AD 665.00 // Satz, Set, Serie, Juego
150mm / 6"

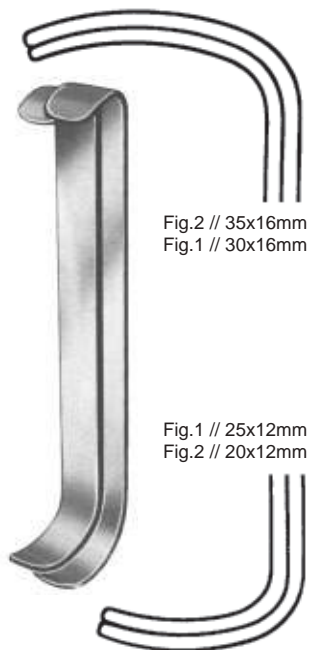

Fig.2 // 35x16mm
 Fig.1 // 30x16mm

Fig.1 // 25x12mm
 Fig.2 // 20x12mm

COLLIN
AD 667.00 // Satz, Set, Serie, Juego
 160mm / 6½"



MINI - ROUX
AD 667.06
 150mm / 6"

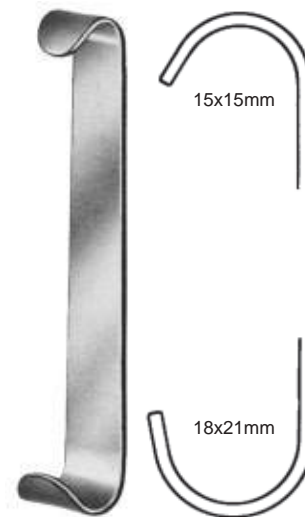

15x15mm

18x21mm

BABY - ROUX
AD 669.13
 130mm / 5"

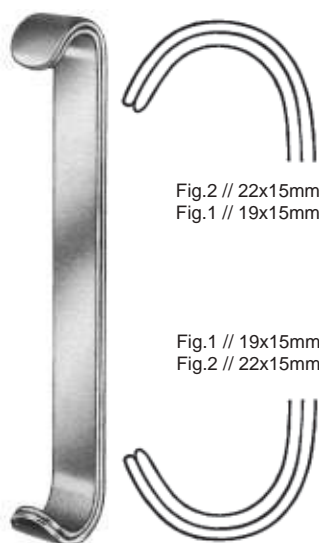

Fig.2 // 22x15mm
 Fig.1 // 19x15mm

Fig.1 // 19x15mm
 Fig.2 // 22x15mm

PARKER
AD 673.01 // Satz, Set, Serie, Juego
 130mm / 5"

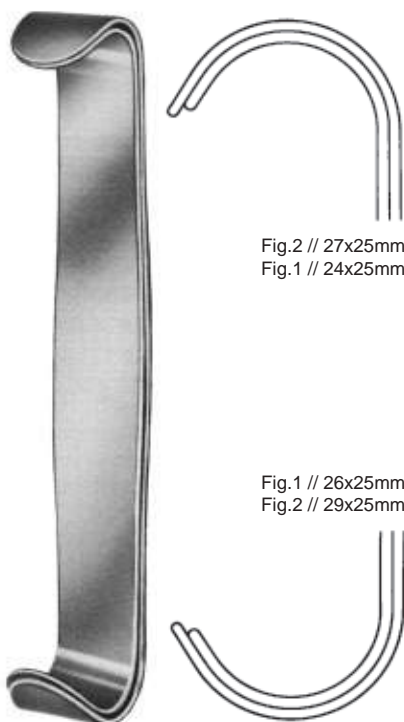

Fig.2 // 27x25mm
 Fig.1 // 24x25mm

Fig.1 // 26x25mm
 Fig.2 // 29x25mm

PARKER
AD 673.02 // Satz, Set, Serie, Juego
 180mm / 7"

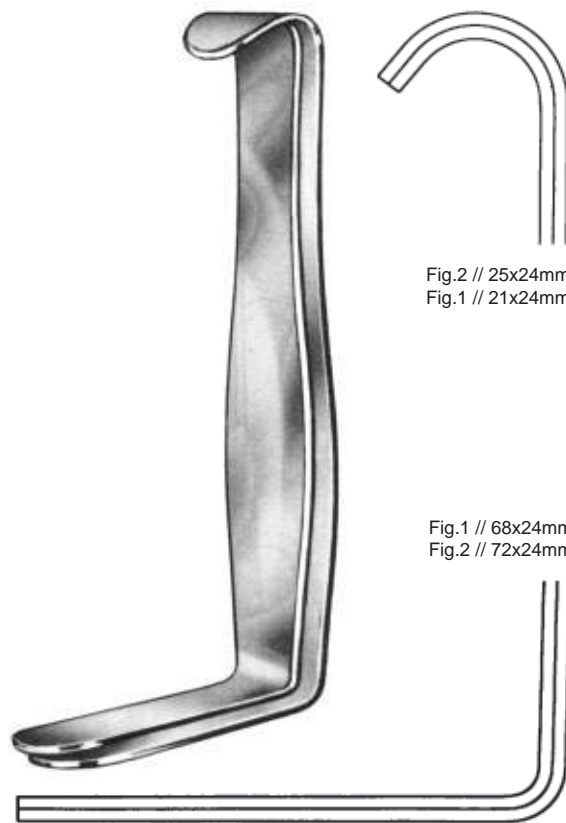
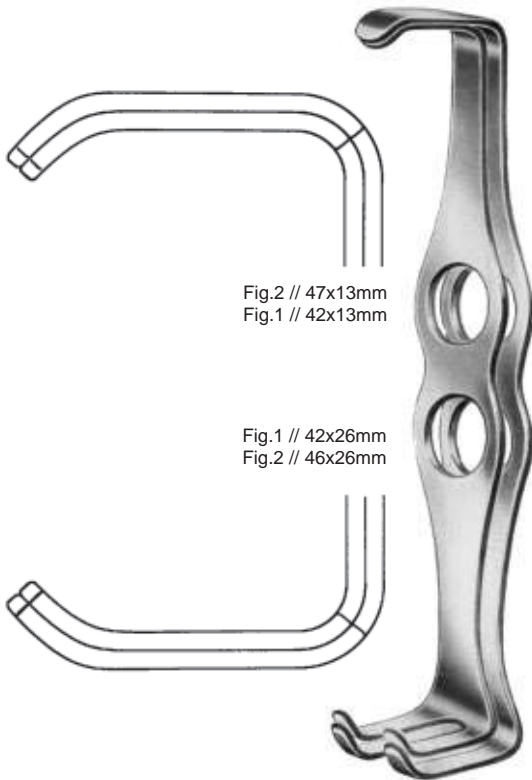

Fig.2 // 25x24mm
 Fig.1 // 21x24mm

Fig.1 // 68x24mm
 Fig.2 // 72x24mm

PARKER - MOTT
AD 675.00 // Satz, Set, Serie, Juego
 160mm / 6½"



MATHIEU
AD 683.00 // Satz, Set, Serie, Juego
 200mm / 8"

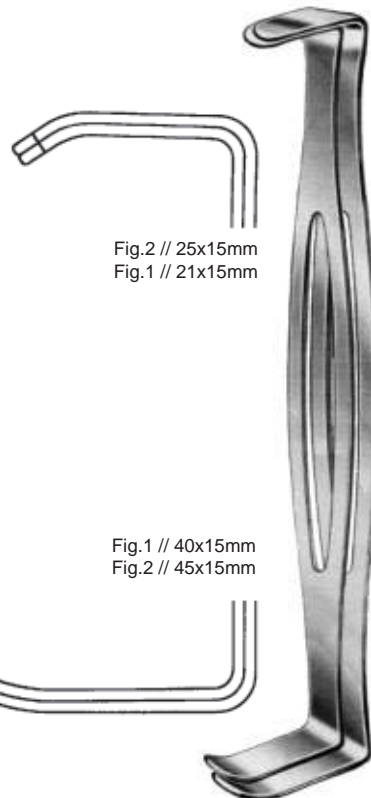

PARKER - LANGENBECK
AD 687.00 // Satz, Set, Serie, Juego
 210mm / 8 1/4"

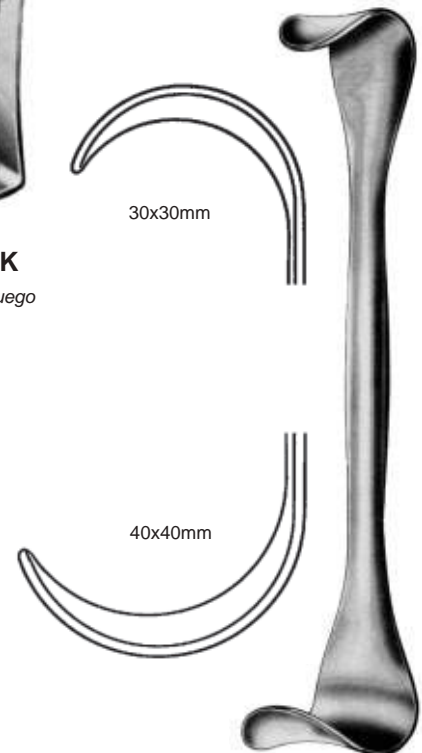

GOELET
AD 695.00
 190mm / 7 1/2"

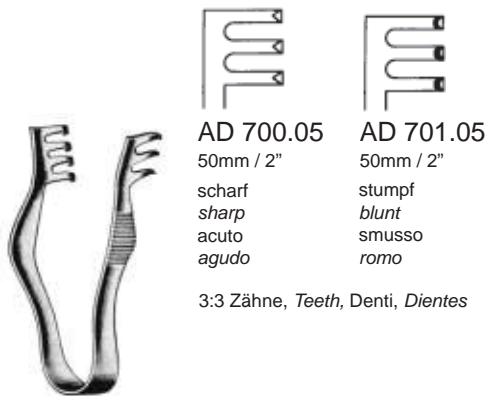

AD 700.05
50mm / 2"
scharf
sharp
acuto
agudo

AD 701.05
50mm / 2"
stumpf
blunt
smusso
romo

3:3 Zähne, *Teeth, Denti, Dientes*

FINSEN
AD 700.05 - AD 703.07

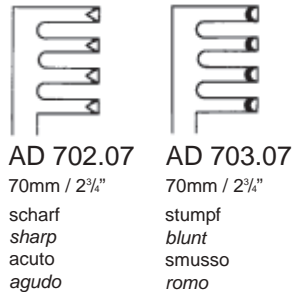

AD 702.07
70mm / 2¾"
scharf
sharp
acuto
agudo

AD 703.07
70mm / 2¾"
stumpf
blunt
smusso
romo

4:4 Zähne, *Teeth, Denti, Dientes*

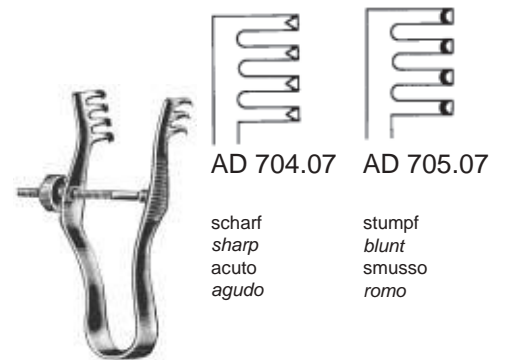

AD 704.07
scharf
sharp
acuto
agudo

AD 705.07
stumpf
blunt
smusso
romo

FINSEN MOD. MARTIN
AD 704.05 - AD 705.07
70mm / 2¾"

3:4 Zähne, *Teeth, Denti, Dientes*



LOGAN
AD 708.04
40mm / 1½"

3:3 Zähne, *Teeth, Denti, Dientes*

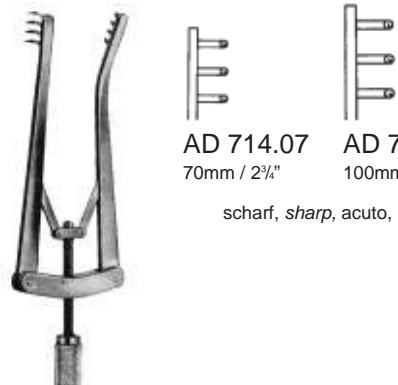

AD 714.07
70mm / 2¾"

AD 714.10
100mm / 4¼"

scharf, *sharp, acuto, agudo*

ALM
AD 714.07 - AD 715.10

4:4 Zähne, *Teeth, Denti, Dientes*

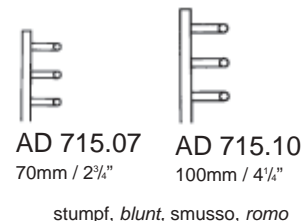

AD 715.07
70mm / 2¾"

AD 715.10
100mm / 4¼"

stumpf, *blunt, smusso, romo*

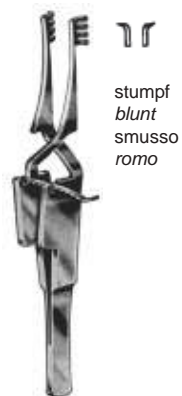

AD 717.10
100mm / 4¼"

4:4 Zähne, *Teeth, Denti, Dientes*

stumpf
blunt
smusso
romo



AD 720.10
scharf, *sharp, acuto, agudo*

JANSEN
AD 720.10 - AD 723.10
100mm / 4¼"

3:3 Zähne, *Teeth, Denti, Dientes*

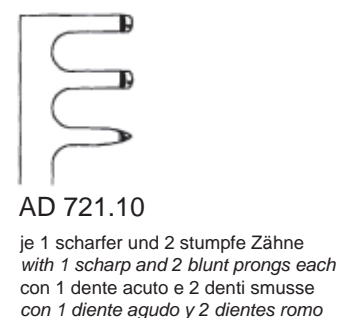

AD 721.10
je 1 scharfer und 2 stumpfe Zähne
with 1 sharp and 2 blunt prongs each
con 1 dente acuto e 2 denti smusse
con 1 diente agudo y 2 dientes romo

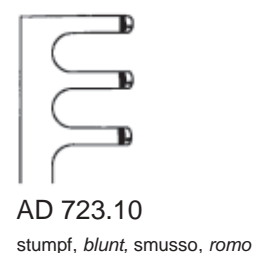

AD 723.10
stumpf, *blunt, smusso, romo*



SNITMAN
AD 724.10
 100mm / 4 1/4"

scharf, *sharp*, acuto, *agudo*
 3:3 Zähne, *Teeth*, Denti, *Dientes*



SCALP - CONTOUR
AD 725.14 - AD 727.14
 140mm / 5 1/2"

3:4 Zähne, *Teeth*, Denti, *Dientes*

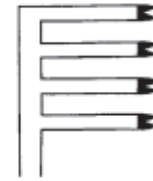

AD 725.14
 scharf, *sharp*, acuto, *agudo*



AD 727.14
 stumpf, *blunt*, smusso, *romo*

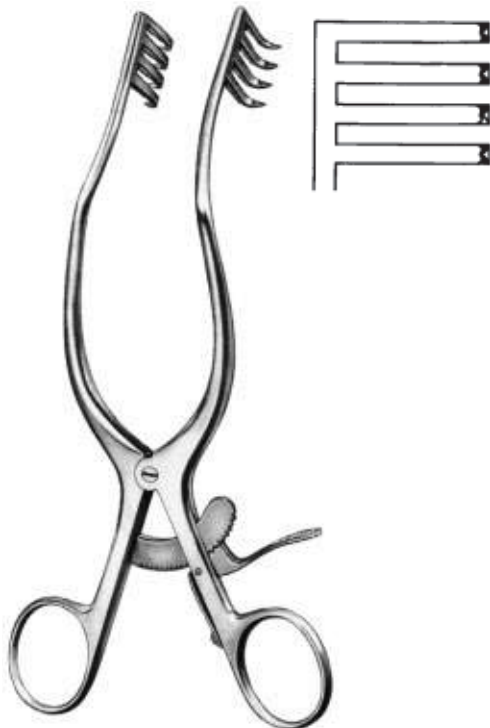

ANDERSON - ADSON
AD 732.20
 200mm / 8"
 4:4 Zähne, *Teeth*, Denti, *Dientes*



WEITLANER
AD 734.20 - AD 735.24

3:4 Zähne, *Teeth*, Denti, *Dientes*

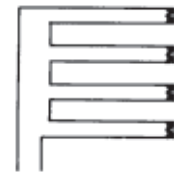

AD 734.20
 200mm / 8"
AD 734.24
 240mm / 9 1/2"
 scharf, *sharp*, acuto, *agudo*

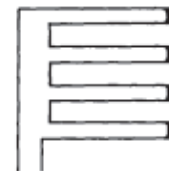

AD 735.20
 200mm / 8"
AD 735.24
 240mm / 9 1/2"
 stumpf, *blunt*, smusso, *romo*



ADSON
AD 736.26 - AD 739.26
 260mm / 10 1/4"

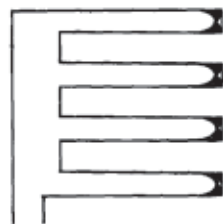

AD 736.26
 scharf, *sharp*, acuto, *agudo*

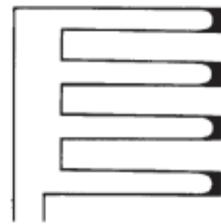

AD 737.26
 stumpf, *blunt*, smusso, *romo*

3:4 Zähne, *Teeth*, *Denti*, *Dientes*

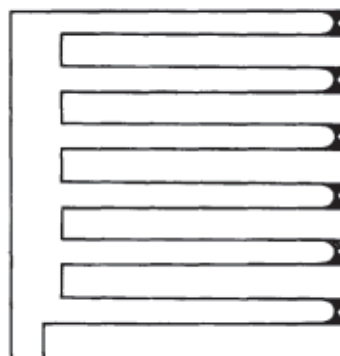

AD 738.26
 scharf, *sharp*, acuto, *agudo*

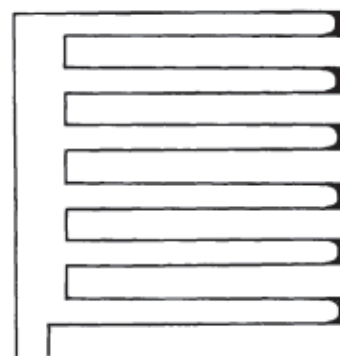

AD 739.26
 stumpf, *blunt*, smusso, *romo*

6x6 Zähne, *Teeth*, *Denti*, *Dientes*



WEITLANER - LOKTITE
AD 748.10 - AD 749.10
 100mm / 4 1/4"

2:3 Zähne, *Teeth*, *Denti*, *Dientes*

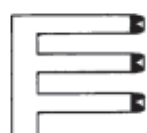

AD 748.10
 scharf, *sharp*, acuto, *agudo*

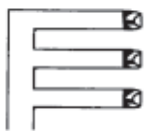

AD 749.10
 stumpf, *blunt*, smusso, *romo*



WEITLANER
AD 750.13 - AD 751.16

3:4 Zähne, *Teeth*, *Denti*, *Dientes*



AD 750.13
 130mm / 5"
 stumpf, *blunt*, smusso, *romo*



AD 751.13
 130mm / 5"
 scharf, *sharp*, acuto, *agudo*



AD 750.16
 160mm / 6 1/2"
 scharf, *sharp*, acuto, *agudo*



AD 751.16
 160mm / 6 1/2"
 stumpf, *blunt*, smusso, *romo*

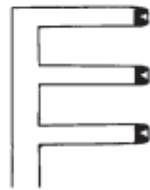

AD 752.13
 130mm / 5"
 scharf, sharp, acuto, agudo

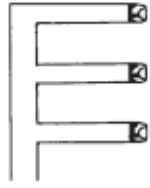

AD 753.13
 130mm / 5"
 stumpf, blunt, smusso, romo

WEITLANER - WULLSTEIN
 AD 752.13 - AD 753.13
 130mm / 5"
 3:3 Zähne, Teeth, Denti, Dientes



scharf, sharp, acuto, agudo

MOLLISON
 AD 754.15
 150mm / 6"
 4:4 Zähne, Teeth, Denti, Dientes



AD 755.13
 stumpf, blunt,
 smusso, romo



AD 756.13
 scharf, sharp,
 acuto, agudo

PLESTER
 AD 755.13 - AD 756.13
 130mm / 5"
 2:2 Zähne, Teeth, Denti, Dientes



stumpf, blunt,
 smusso, romo

PLESTER
 AD 757.11
 110mm / 4½"
 2 Zähne, Teeth, Denti, Dientes

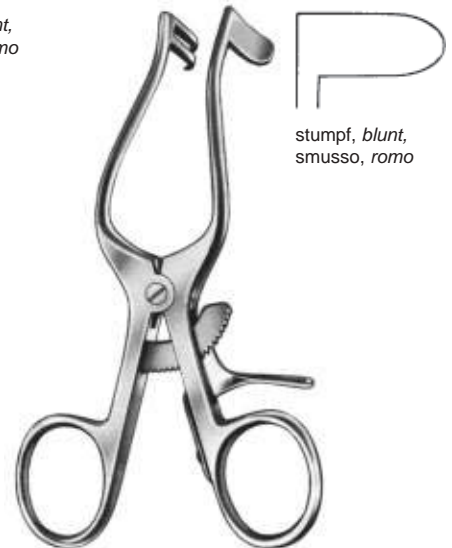

stumpf, blunt,
 smusso, romo

PLESTER
 AD 759.11
 110mm / 4½"
 2 Zähne, Teeth, Denti, Dientes

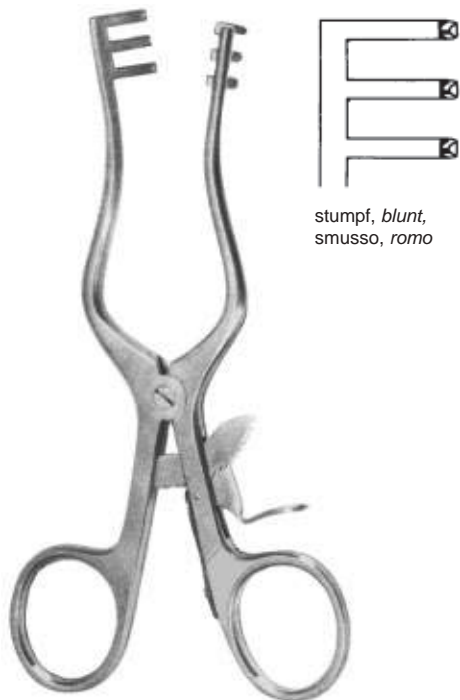

stumpf, *blunt*,
 smusso, *romo*

MILLIGAN
AD 765.13
 130mm / 5"

3:3 Zähne, *Teeth, Denti, Dientes*

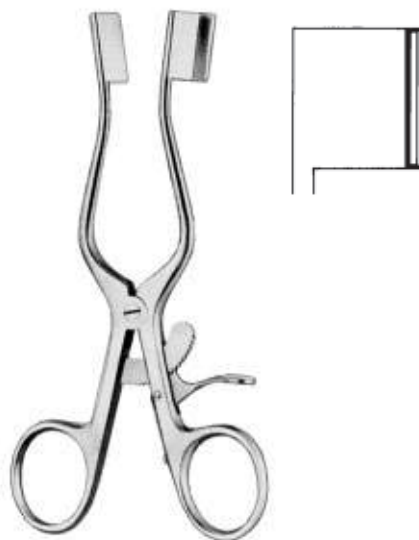

WEITLANER - BABY
AD 767.13
 130mm / 5"

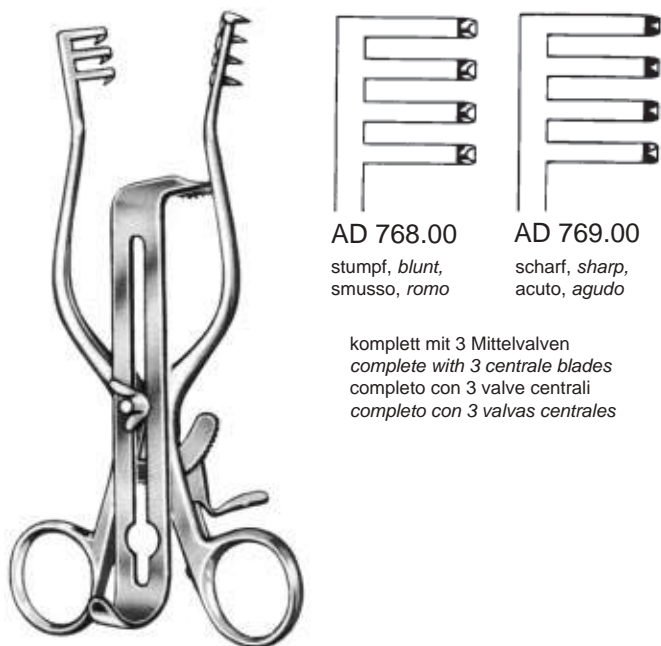

AD 768.00
 stumpf, *blunt*,
 smusso, *romo*

AD 769.00
 scharf, *sharp*,
 acuto, *agudo*

komplett mit 3 Mittelvalven
complete with 3 centrale blades
 completo con 3 valve centrali
 completo con 3 valvas centrales

HENLEY
AD 768.00 - AD 769.00
 160mm / 6½"

3:4 Zähne, *Teeth, Denti, Dientes*



AD 768.19
 16x19mm



AD 768.25
 16x25mm



AD 768.32
 16x32mm

Mittelvalven, allein
Central blades, only
 Valve centrali, solo
 Valvas centrales, *sueltas*



ADSON
AD 770.13 - AD 771.26

3:4 Zähne, *Teeth, Denti, Dientes*



AD 770.13
130mm / 5"

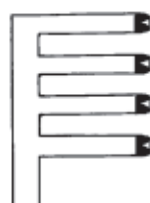

AD 770.16
160mm / 6½"



AD 770.20
200mm / 8"

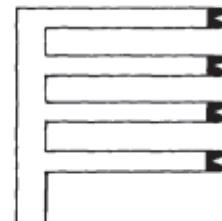

AD 770.26
260mm / 10¼"

scharf, *sharp, acuto, agudo*

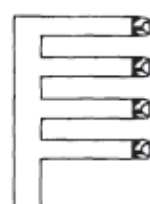

AD 771.13
130mm / 5"

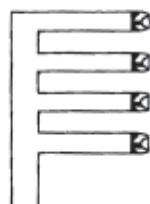

AD 771.16
160mm / 6½"

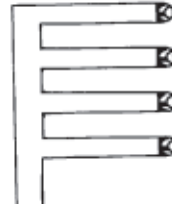

AD 771.20
200mm / 8"

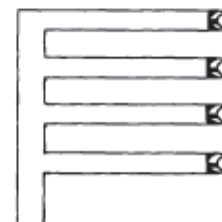

AD 771.26
260mm / 10¼"

stumpf, *blunt, smusso, romo*



CLOWARD
 AD 774.00 - AD 774.60
 250mm / 10"



AD 774.40
 40mm



AD 774.45
 45mm



AD 774.50
 50mm



AD 774.55
 55mm



AD 774.60
 60mm



CLOWARD
 AD 775.00 - AD 775.60
 160mm / 6½"



AD 775.40
 40mm



AD 775.45
 45mm



AD 775.50
 50mm



AD 775.55
 55mm



AD 775.60
 60mm



BECKMANN

AD 776.31

310mm / 12 1/4"

4:4 Zähne, *Teeth, Denti, Dientes*



ADSON

AD 777.32

320mm / 12 1/2"

4:5 Zähne, *Teeth, Denti, Dientes*



BECKMANN - ADSON
AD 778.00 - AD 778.03
 310mm / 12 1/8"
 4:4 Zähne, Teeth, Denti, Dientes

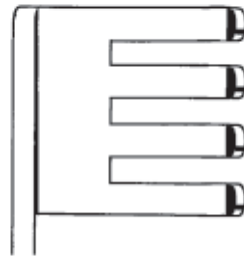

AD 778.00
 stumpf, blunt, smusso, romo



AD 778.01
 scharf, sharp, acuto, agudo

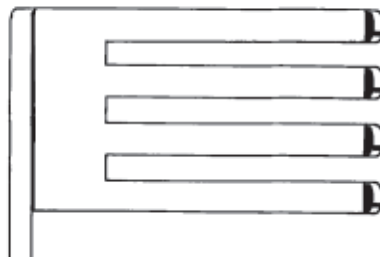

AD 778.02
 stumpf, blunt, smusso, romo

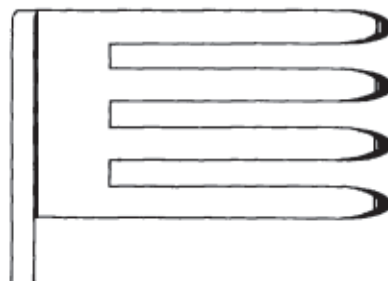

AD 778.03
 scharf, sharp, acuto, agudo

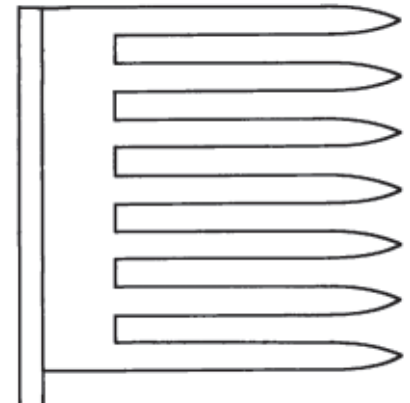

BECKMANN - EATON
AD 778.32
 320mm / 12 1/2"
 7:7 Zähne, Teeth, Denti, Dientes

Hemilaminectomie-Sperrer
Hemilaminectomy-Retractor
Divaricatore per emilaminectomia
Separadores de hemilaminectomia

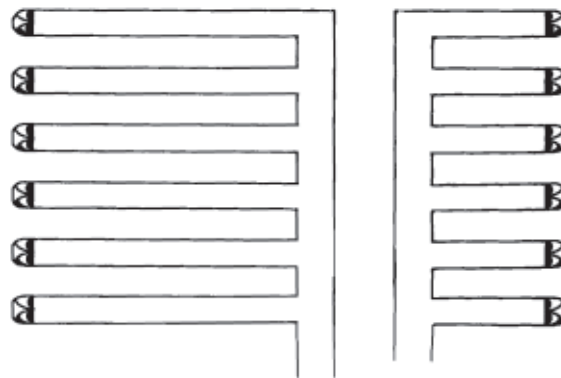

AD 790.01

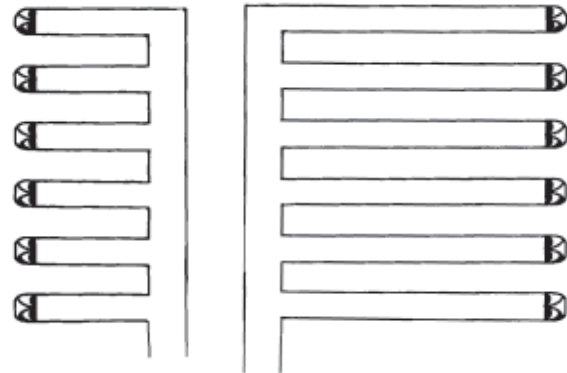

AD 790.02

AD 790.01 - AD 790.02
270mm / 10½"

6:6 Zähne, *Teeth, Denti, Dientes*



Mittelblatt allein, 10x18mm
Centrale blade only, 10x18mm
Valva centrale sola, 10x18mm
Valva central suelta, 10x18mm

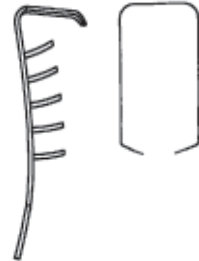

AD 792.01

Mittelblatt allein, 10x12mm
Centrale blade only, 10x12mm
Valva centrale sola, 10x12mm
Valva central suelta, 10x12mm



AD 792.02

**VICKERS LOW-PROFILE
AD 792.00**

Komplett mit Mittelblatt 10x18mm
Complet with central blade 10x18mm
Completo con valva centrale 10x18mm
Completo con valva central 10x18mm



Mittelblatt allein, 10x18mm
Centrale blade only, 10x18mm
Valva centrale sola, 10x18mm
Valva central suelta, 10x18mm



AD 792.01

Mittelblatt allein, 10x12mm
Centrale blade only, 10x12mm
Valva centrale sola, 10x12mm
Valva central suelta, 10x12mm

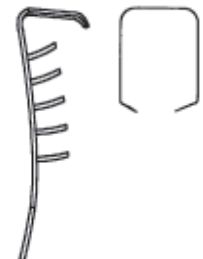

AD 792.02

**VICKERS LOW-PROFILE
AD 793.00**

Komplett mit Mittelblatt 10x18mm
Complet with central blade 10x18mm
Completo con valva centrale 10x18mm
Completo con valva central 10x18mm



Mittelblatt allein, 10x18mm
Centrale blade only, 10x18mm
Valva centrale sola, 10x18mm
Valva central suelta, 10x18mm



AD 792.01

Mittelblatt allein, 10x12mm
Centrale blade only, 10x12mm
Valva centrale sola, 10x12mm
Valva central suelta, 10x12mm



AD 792.02

**VICKERS LOW-PROFILE
AD 794.00**

Komplett mit Mittelblatt 10x18mm
Complet with central blade 10x18mm
Completo con valva centrale 10x18mm
Completo con valva central 10x18mm



**VICKERS
AD 798.01**



JACKSON - BURROWS
AD 801.18

180mm / 7"

stumpf, blunt, smusso, romo



GELPI - LOKTITE
AD 802.13

130mm / 5"



GELPI - LOKTITE
AD 802.18

180mm / 7"



GELPI - LOKTITE
AD 804.18

180mm / 7"



DE BAKEY
AD 810.15

150mm / 6"

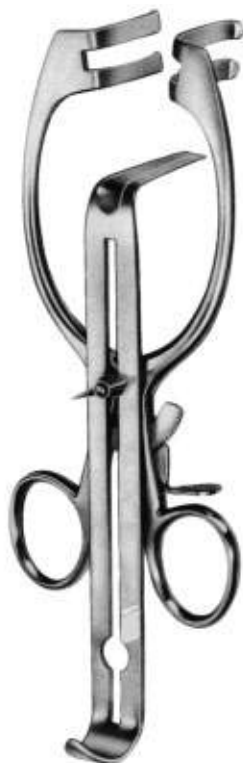

MAYO - ADAMS
AD 817.17
 170mm / 6 3/4"



BABY - COLLIN
AD 820.00

Komplett mit 2 Paar Valven
 Complete with 2 pairs of blades
 Completo con 2 paia di valve
 Completo con 2 pares des valvas



COLLIN
AD 822.22

Komplett mit 1 Paar Valven
 Complete with 1 pairs of blades
 Completo con 1 paia di valve
 Completo con 1 par de valvas



⌀100mm

Mittelvalven	Seitenvalven
<i>Central Blades</i>	<i>Lateral Blades</i>
Valve centrali	Valve laterali
Valvas centrales	Valvas laterales

COLLIN		
AD 823.00	38x55mm	38x60mm
AD 824.00	50x75mm	38x80mm

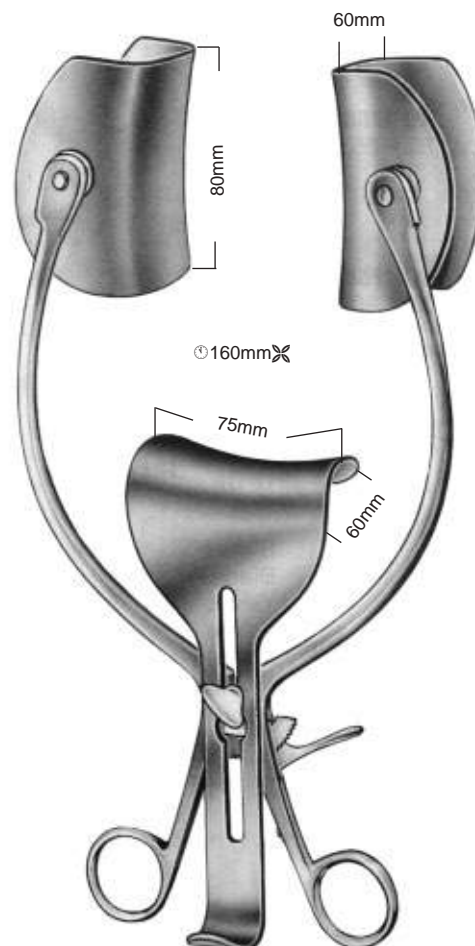

COLLIN - LOKTITE
AD 826.00
 260mm / 10 1/4"

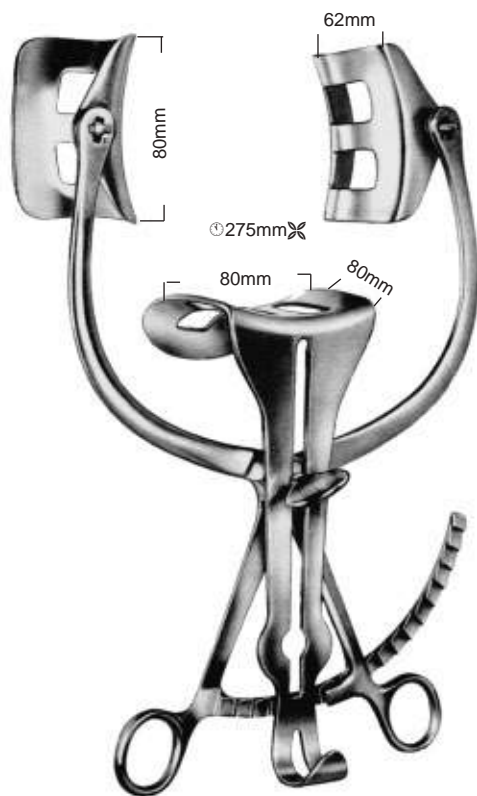

HOLZBACH
AD 827.00
 Komplett, complete
 completo, completo

AD 827.01

Sperrer allein, Retractor only,
 Allargatore solo, Separador suelto

AD 827.02

62x80mm

Seitenvalve, Lateral Blade,
 Valva laterale, Valva laterales

AD 827.03

80x80mm

Mittelvalve, Central Blade,
 Valva centrale, Valva centrales



AD 828.01

Sperrer allein, Retractor only,
 Allargatore solo, Separador suelto

AD 830.02

55x70mm

AD 830.04

80x90mm

Mittelvalven, Central Blades, Valve centrali, Valvas centrales

AD 839.90

50x58mm

AD 839.92

60x80mm

AD 839.94

72x85mm

Seitenvalven, Lateral Blades, Valve laterali, Valvas laterales

RICARD

AD 828.00 // 280mm / 11"

AD 830.00 // 300mm / 12"

Komplett, complete,
 completo, completo

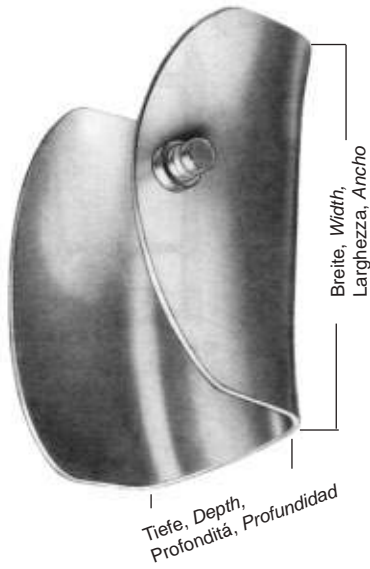

AD 839.18 - AD 839.60

AD 839.18
18x40mm



AD 839.27
27x40mm

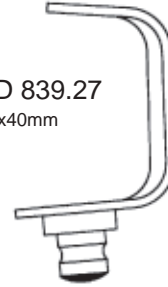

AD 839.38
38x60mm

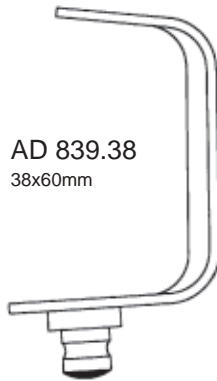

AD 839.40
40x80mm

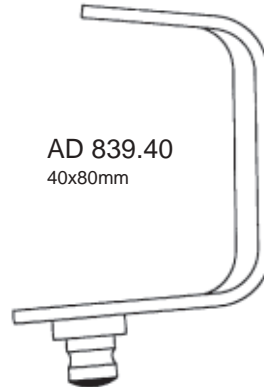

AD 839.45
45x80mm

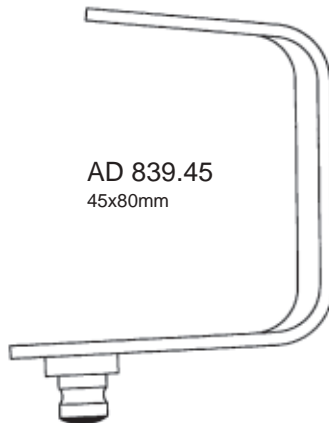

AD 839.60
60x80mm

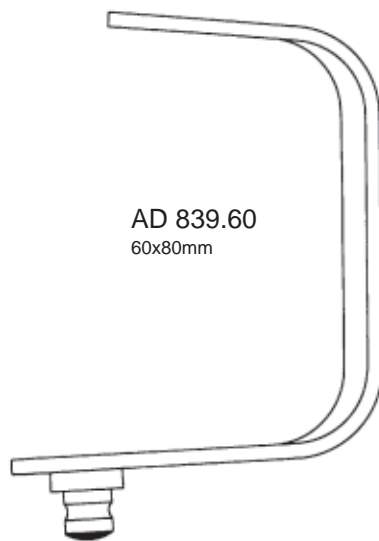

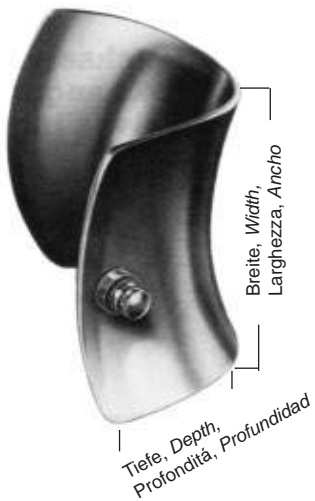
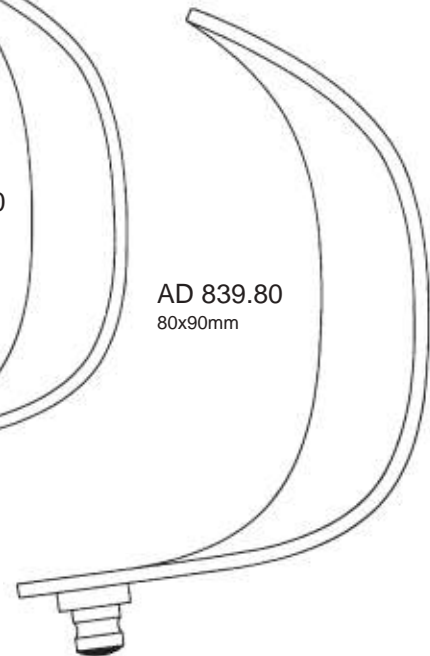
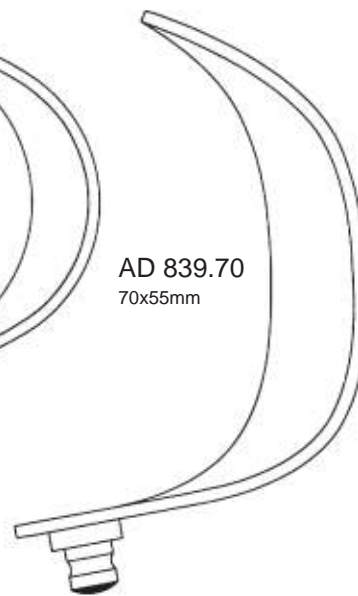

AD 839.50 - AD 839.94

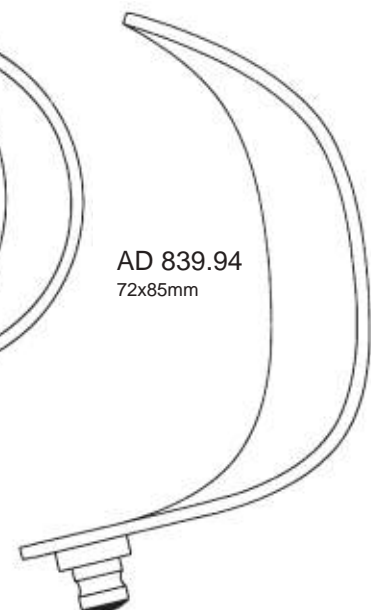
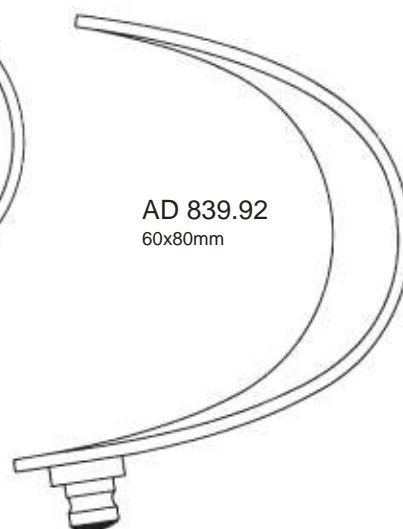



GOSSET
AD 840.00



LEGUEU
AD 842.00



GOSSET
AD 844.00

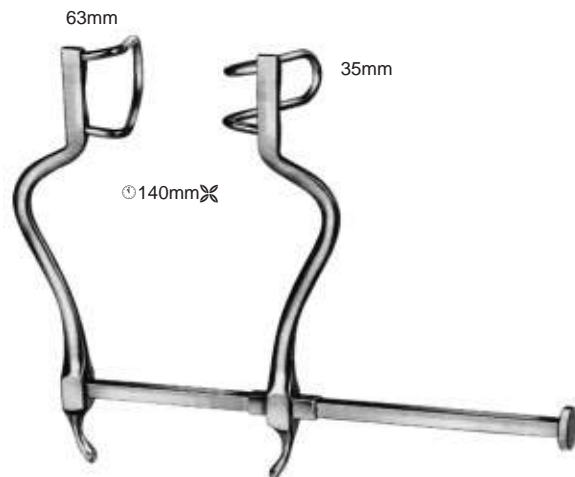

GOSSET
AD 846.00

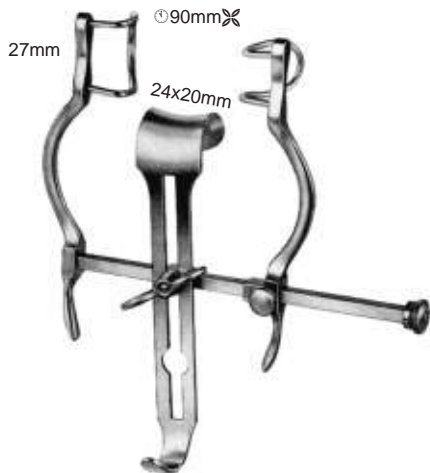

BALFOUR - BABY
AD 850.00



BALFOUR
AD 852.00



BALFOUR
AD 854.00

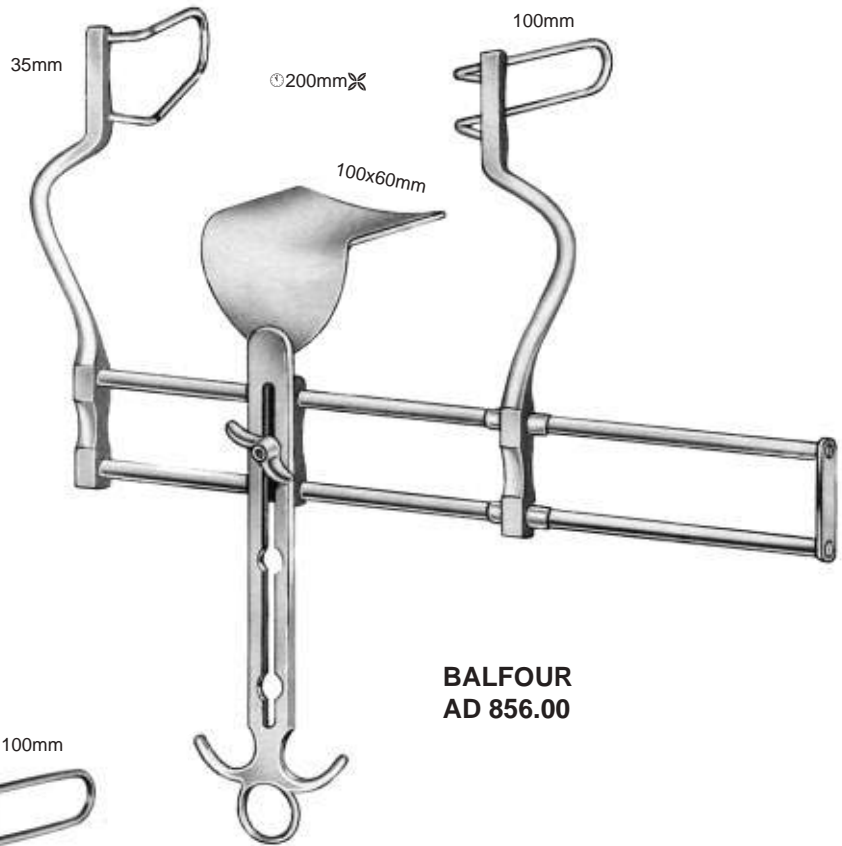

BALFOUR
AD 856.00

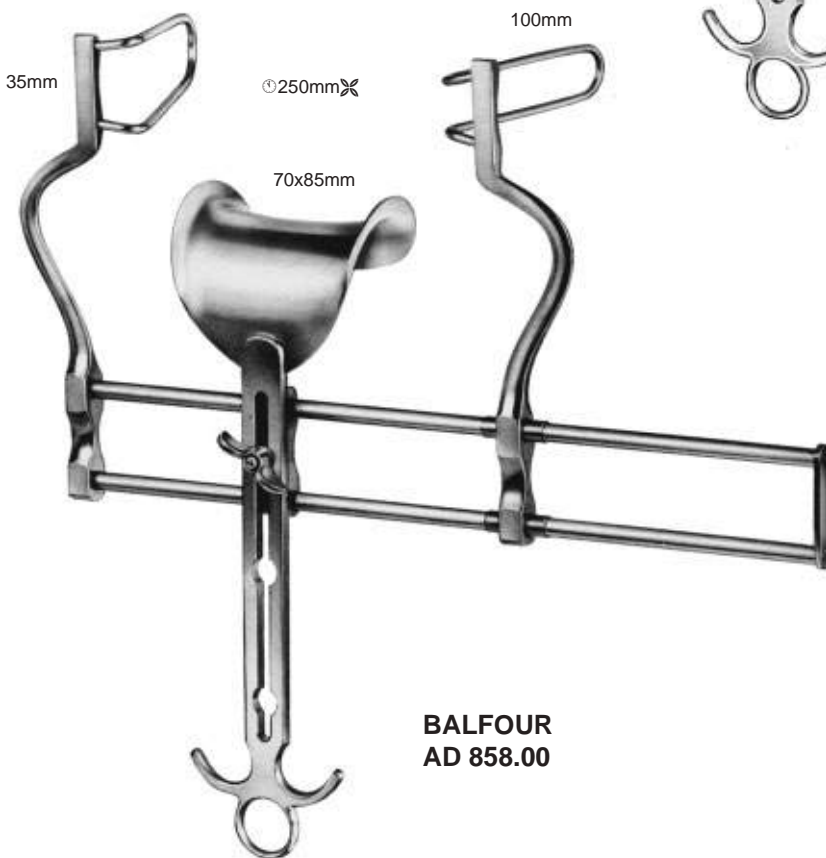

BALFOUR
AD 858.00



BALFOUR
AD 858.01 // 100x60mm



BALFOUR
AD 859.01 // 45x80mm
AD 859.02 // 70x85mm

Bauchdeckenhalter
Abdominal Retractors
Divaricatori addominali
Separadores abdominales

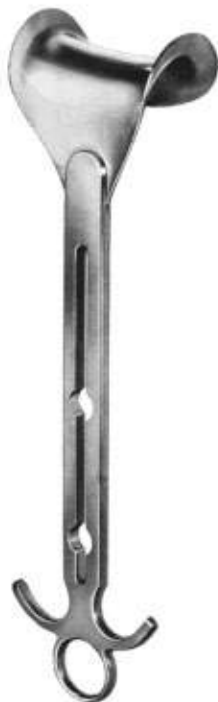

AD 859.05 // 68x86mm
AD 859.06 // 40x68mm



BALFOUR US - TYPE
AD 860.00

Komplett mit 2 Paar Valven
 Complete with 2 pairs of blades
 Completo con 2 paia di valve
 Completo con 2 pares de valvas



AD 860.06
 70x35mm



AD 860.08
 100x35mm

AD 866.40
 40x40mm

AD 866.30
 40x30mm

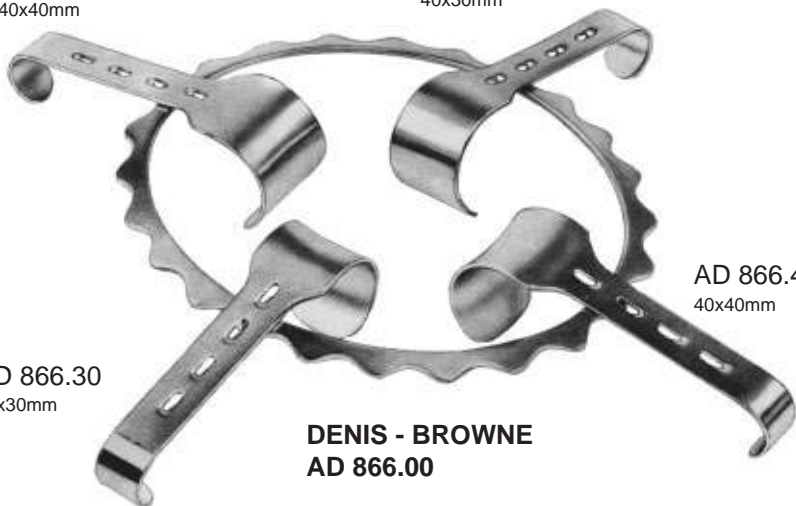

AD 866.30
 40x30mm

AD 866.40
 40x40mm

DENIS - BROWNE
AD 866.00

AD 866.00 Denis-Browne Bauchdeckenhalter, komplett mit:
 AD 866.01 1 Rahmen 190x160mm
 AD 866.30 2 Rahmenhaken 40x30mm
 AD 866.40 2 dito, 40x40mm

AD 866.00 Denis-Browne Abdominal Retractor, complete with:
 AD 866.01 1 Frame 190x160mm
 AD 866.30 2 Hook-on retractors 40x30mm
 AD 866.40 2 ditto, 40x40mm

AD 866.00 Denis-Browne Divaricatore, completo di:
 AD 866.01 1 Telaio 190x160mm
 AD 866.30 2 Valve 40x30mm
 AD 866.40 2 idem 40x40mm

AD 866.00 Denis-Browne Separador, completo de:
 AD 866.01 1 Cuadro 190x160mm
 AD 866.30 2 Valvas 40x30mm
 AD 866.40 2 idem 40x40mm



O'SULLIVAN - O'CONNOR
AD 868.00

Bauchdeckenhalter
Abdominal Retractors
Divaricatori addominali
Separadores abdominales

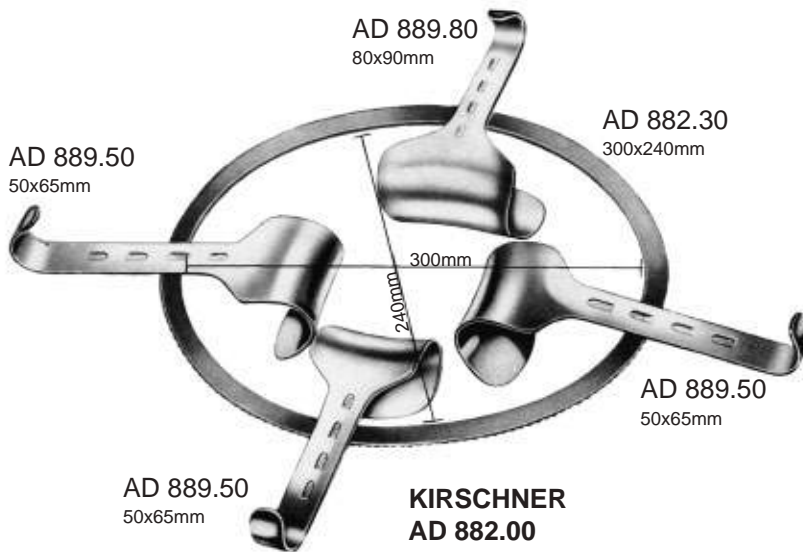

- AD 882.00 Kirschner Bauchdeckenhalter, komplett mit:
 AD 882.30 1 Rahmen 300x240mm
 AD 889.50 3 Rahmenhaken 50x65mm
 AD 889.80 1 dito, 80x90mm
 AD 889.98 1 dito, 98x50mm
 AD 889.99 1 dito, 105x35mm

- Kirschner Abdominal Retractor, oval, complete with:*
 1 Frame 300x240mm
 3 Hook-on retractors 50x65mm
 1 ditto, 80x90mm
 1 ditto, 98x50mm
 1 ditto, 105x35mm

- AD 882.00 Kirschner Divaricatore, ovale, completo di:
 AD 882.30 1 Telaio 300x240mm
 AD 889.50 3 Valve 50x65mm
 AD 889.80 1 idem, 80x90mm
 AD 889.98 1 idem, 98x50mm
 AD 889.99 1 idem, 105x35mm

- Kirschner Separador, oval, completo de:*
 1 Cuadro 300x240mm
 3 Valvas 50x65mm
 1 idem, 80x90mm
 1 idem, 98x50mm
 1 idem, 105x35mm

AD 889.99
105x35mm

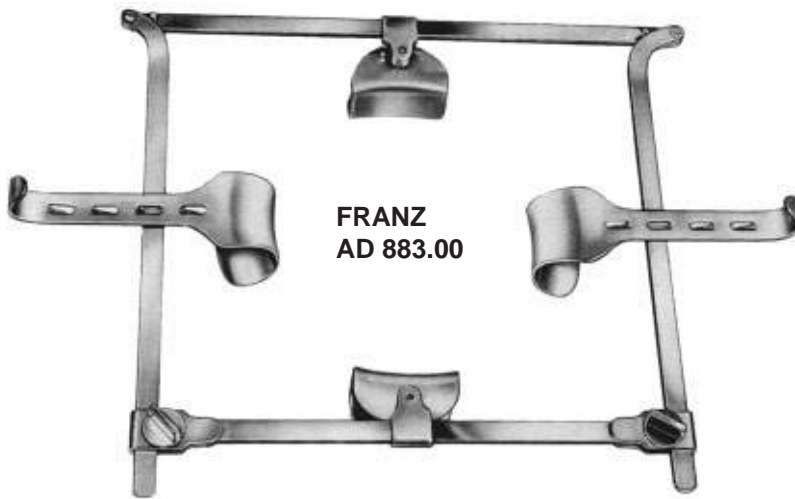

- AD 883.00 Franz Bauchdeckenhalter, komplett mit:
 AD 883.02 1 Rahmen 300x300mm
 AD 889.50 2 Rahmenhaken 50x65mm
 AD 839.38 2 Valven 38x60mm

- Franz Abdominal Retractor, complete with:*
 1 Frame 300x300mm
 2 Hook-on retractors 50x65mm
 2 Blades 38x60mm

- AD 883.00 Franz Divaricatore, completo di:
 AD 883.02 1 Telaio 300x300mm
 AD 889.50 2 Valve 50x65mm
 AD 839.38 2 idem, 38x60mm

- Franz Separador, completo de:*
 1 Cuadro 300x300mm
 2 Valvas 50x65mm
 2 idem, 38x60mm

AD 839.38 // 38x60mm
 AD 839.45 // 45x80mm

FRANZ
AD 883.01

- AD 883.01 Franz Bauchdeckenhalter, komplett mit:
 AD 883.02 1 Rahmen 300x300mm
 AD 889.50 2 Rahmenhaken 50x65mm
 AD 889.60 2 dito, 60x85mm
 AD 839.38 2 Valven 38x60mm
 AD 839.45 2 dito, 45x80mm
 AD 883.01 Franz Divaricatore, completo di:
 AD 883.02 1 Telaio 300x300mm
 AD 889.50 2 Valve 50x65mm
 AD 889.60 2 idem, 60x85mm
 AD 839.38 2 idem, 38x60mm
 AD 839.45 2 idem, 45x80mm

- Franz Abdominal Retractor, complete with:*
 1 Frame 300x300mm
 2 Hook-on retractors 50x65mm
 2 ditto, 60x85mm
 2 Blades 38x60mm
 2 ditto, 45x80mm

- Franz Separador, completo de:*
 1 Cuadro 300x300mm
 2 Valvas 50x65mm
 2 idem, 60x85mm
 2 idem, 38x60mm
 2 idem, 45x80mm

AD 889.50 // 50x65mm
 AD 889.60 // 60x85mm

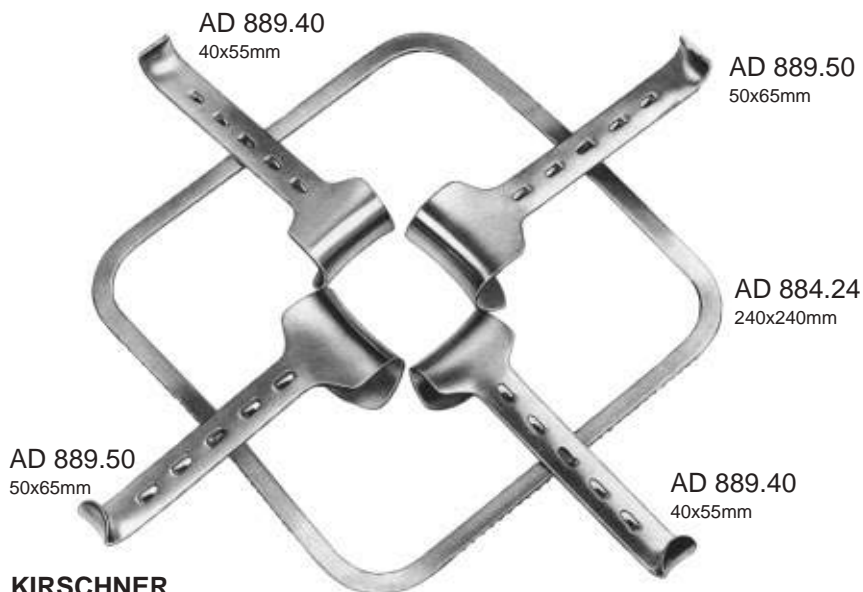

KIRSCHNER
AD 884.00

AD 884.00 Kirschner Bauchdeckenhalter, oval, komplett mit:
 AD 884.24 1 Rahmen 240x240mm
 AD 889.40 2 Rahmenhaken 40x55mm
 AD 889.50 2 dito, 50x65mm

AD 884.00 Kirschner Divaricatore, ovale, completo di:
 AD 884.24 1 Telaio 240x240mm
 AD 889.40 2 Valve 40x55mm
 AD 889.50 2 idem 50x65mm

Kirschner Abdominal Retractor, oval, complete with:
 1 Frame 240x240mm
 2 Hook-on retractors 40x55mm
 2 ditto, 50x65mm

Kirschner Separador, oval, completo de:
 1 Cuadro 240x240mm
 2 Valvas 40x55mm
 2 idem 50x65mm

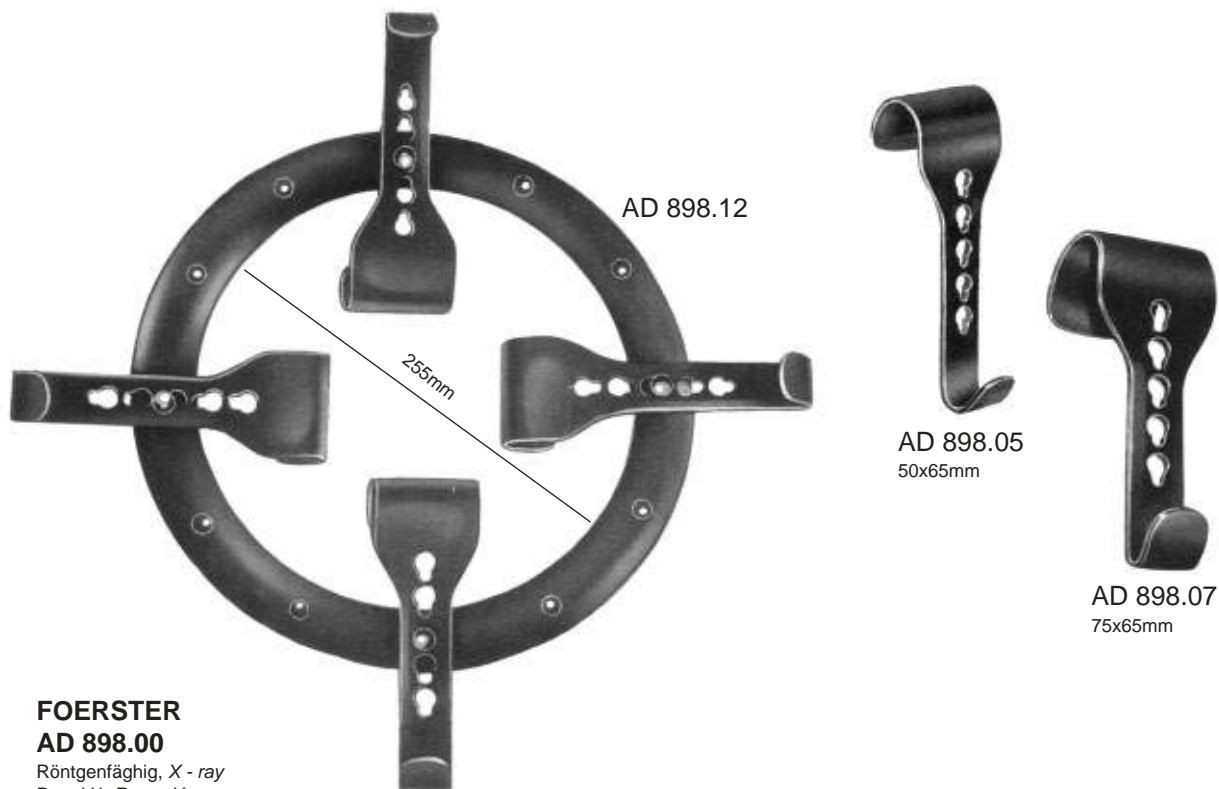

FOERSTER
AD 898.00

Röntgenfähig, X - ray
 Raggi X, Rayos X

AD 898.00 Foerster Bauchdeckenhalter, komplett mit:
 AD 898.12 1 Rahmen
 AD 898.05 4 Rahmenhaken 50x65mm

AD 898.00 Foerster Divaricatore, completo di:
 AD 898.12 1 Telaio
 AD 898.05 4 Valve 50x65mm

Foerster Kirschner Abdominal Retractor, complete with:
 1 Frame
 4 Hook-on retractors 50x65mm

Foerster Separador, completo de:
 1 Cuadro
 4 Valvas 50x65mm

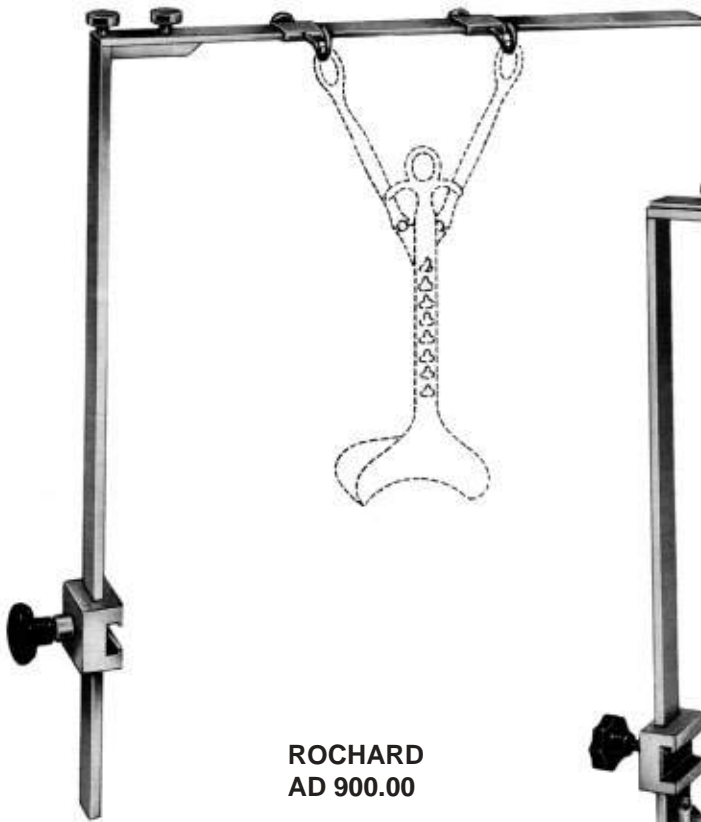

ROCHARD
AD 900.00

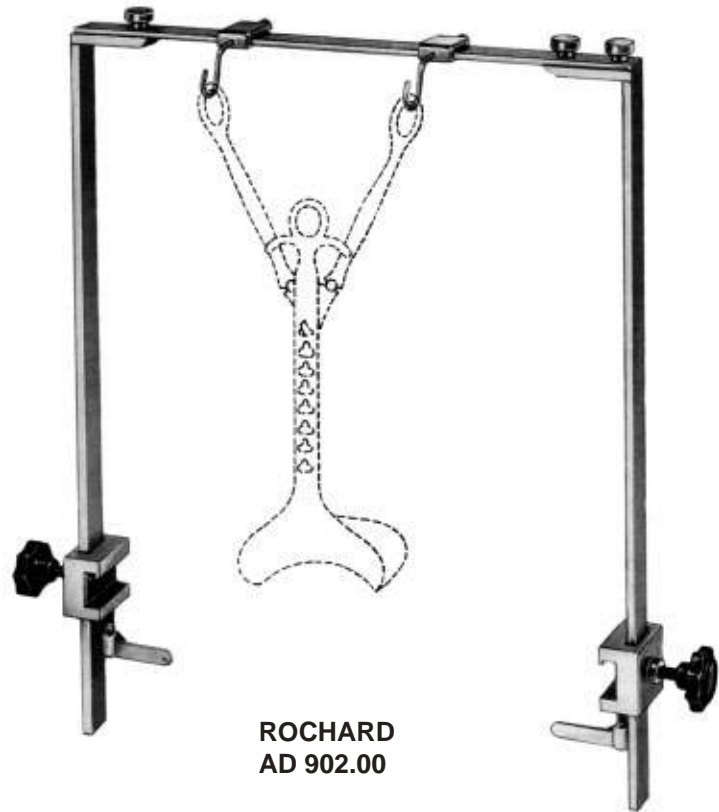

ROCHARD
AD 902.00



ROCHARD
AD 900.01
190mm / 7½"

ROCHARD
AD 900.09 - AD 900.15
270mm / 10½"

- AD 900.09 // 50x95mm
- AD 900.10 // 60x105mm
- AD 900.12 // 60x120mm
- AD 900.13 // 60x135mm
- AD 900.15 // 60x155mm





⊙150mm

⊙150mm

**SCOVILLE
 AD 906.00**

Rahmen allein, *Frame only*,
 Telaio solo, *Cuadro suelto*

**SCOVILLE
 AD 906.50**

Rahmen allein, *Frame only*,
 Telaio solo, *Cuadro suelto*



**SCOVILLE
 AD 906.01**

50mm / 2"



**SCOVILLE
 AD 906.02**

70mm / 2¾"



**SCOVILLE
 AD 906.06**

50mm / 2"



**SCOVILLE
 AD 906.07**

70mm / 2¾"



**SCOVILLE
 AD 906.11 // 64x25mm
 AD 906.12 // 64x50mm
 AD 906.13 // 88x25mm**



**SCOVILLE
 AD 906.41 // 48x50mm
 AD 906.42 // 64x50mm
 AD 906.43 // 64x64mm
 AD 906.44 // 80x57mm**



**SCOVILLE
 AD 906.46 // 41x38mm
 AD 906.47 // 67x44mm**



46mm
REVERDIN
AD 953.28
 280mm / 11"



- AD 963.20** // 330mm x 20mm
- AD 963.25** // 330mm x 25mm
- AD 963.30** // 330mm x 30mm
- AD 963.35** // 330mm x 35mm
- AD 963.40** // 330mm x 40mm
- AD 963.45** // 330mm x 45mm
- AD 963.50** // 330mm x 50mm

biegsam, *flexible*,
 malleabile, *malleables*



HABERER

- AD 971.00** // 200mm x 17x25mm
- AD 971.01** // 280mm x 25x30mm
- AD 971.02** // 300mm x 37x45mm

biegsam, *flexible*,
 malleabile, *malleables*

biegsam, sehr weich
flexible, very soft
 malleabile, molto morbido
malleables, muy blandos



MARTIN

- AD 975.06** // 200mm x 6,5mm
- AD 975.09** // 200mm x 9,5mm
- AD 975.13** // 200mm x 13mm
- AD 975.16** // 200mm x 16mm
- AD 975.19** // 200mm x 19mm
- AD 975.25** // 200mm x 25mm



NADELHALTER
NEEDLE HOLDERS
PORTAGHI
PORTA - AGUJAS

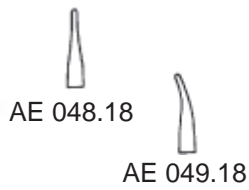

AE 048.18 - AE 049.18
 180mm / 7"
 Mit Sperre, *with ratchet*,
 con cremagliera, *con cremallera*

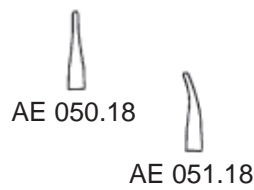

AE 050.18 - AE 051.18
 180mm / 7"
 Ohne Sperre, *without ratchet*,
 senza cremagliera, *sin cremallera*



BARRAQUER
AE 264.14
 140mm / 5½"



KALT
AE 274.14
 140mm / 5½"

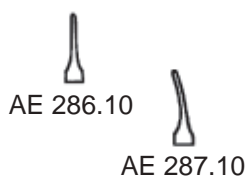

BARRAQUER - TROUTMAN
AE 286.10 - AE 287.10
 100mm / 4¼"
 Mit Sperre, *with ratchet*,
 con cremagliera, *con cremallera*

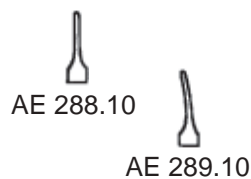

BARRAQUER - TROUTMAN
AE 288.10 - AE 289.10
 100mm / 4¼"
 Ohne Sperre, *without ratchet*,
 senza cremagliera, *sin cremallera*

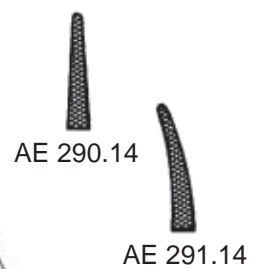

ARRUGA
AE 290.14 - AE 291.14
 140mm / 5½"



BARRAQUER
AE 300.11
 110mm / 4½"

Ohne Sperre, *without ratchet*,
 senza cremagliera, *sin cremallera*



BARRAQUER
AE 300.13
 130mm / 5"



BARRAQUER
AE 300.14
 140mm / 5½"

Mit Sperre, *with ratchet*,
 con cremagliera, *con cremallera*



CASTROVIEJO
AE 302.09 - AE 303.09
 90mm / 3½"
 Ohne Sperre, *without ratchet*,
 senza cremagliera, *sin cremallera*

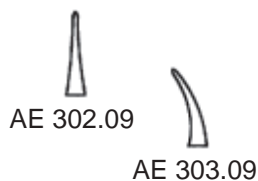

CASTROVIEJO
AE 304.09 - AE 305.09
 90mm / 3½"
 Mit Sperre, *with ratchet*,
 con cremagliera, *con cremallera*

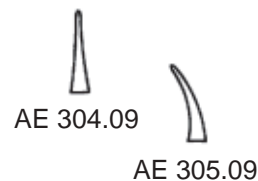



AE 302.13

AE 303.13

**CASTROVIEJO - FINO
 AE 302.13 - AE 303.13**

130mm / 5"
 Ohne Sperre, *without ratchet*,
 senza cremagliera, *sin cremallera*



AE 304.13

AE 305.13

**CASTROVIEJO - FINO
 AE 304.13 - AE 305.13**

130mm / 5"
 Mit Sperre, *with ratchet*,
 con cremagliera, *con cremallera*



AE 306.14

AE 307.14

**CASTROVIEJO
 AE 306.14 - AE 307.14**

140mm / 5½"
 Mit Sperre, *with ratchet*,
 con cremagliera, *con cremallera*



AE 312.14

AE 313.14

**CASTROVIEJO
 AE 312.14 - AE 313.14**

140mm / 5½"
 Ohne Sperre, *without ratchet*,
 senza cremagliera, *sin cremallera*



AE 308.14

AE 309.14

**CASTROVIEJO - STANDARD
 AE 308.14 - AE 309.14**

140mm / 5½"
 Ohne Sperre, *without ratchet*,
 senza cremagliera, *sin cremallera*



AE 310.14

AE 311.14

**CASTROVIEJO - STANDARD
 AE 310.14 - AE 311.14**

140mm / 5½"
 Mit Sperre, *with ratchet*,
 con cremagliera, *con cremallera*

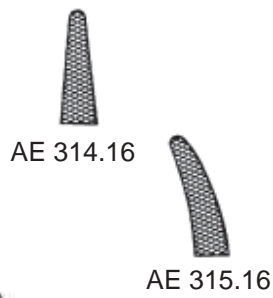

ARRUGA
 AE 314.16 - AE 315.16
 160mm / 6½"



CASTROVIEJO
 AE 316.13
 130mm / 5"



CASTROVIEJO - BARRAQUER
 AE 317.12
 120mm / 4¾"



AE 319.16
 160mm / 6½"



AE 320.23 - AE 323.19

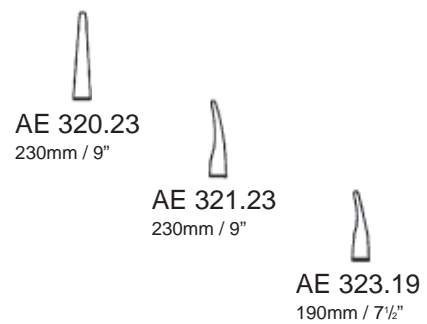



DERF
AE 326.12
120mm / 4³/₄"

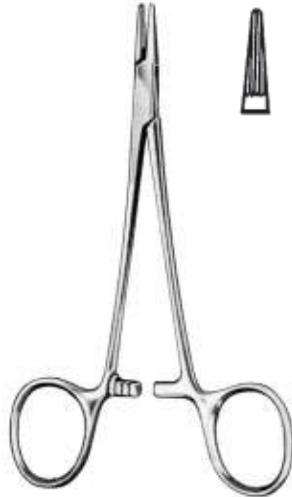

DERF (CONVERSE)
AE 328.12
120mm / 4³/₄"



COLLIER
AE 332.12
120mm / 4³/₄"



WEBSTER
AE 334.13
130mm / 5"

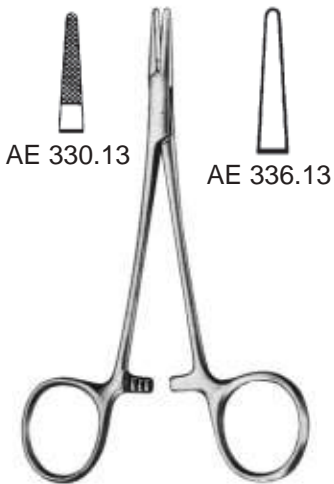

HALSEY
AE 330.13
AE 336.13
130mm / 5"

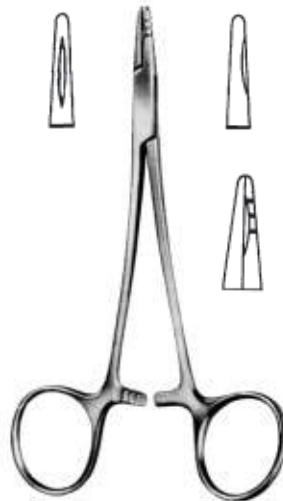

NEIVERT
AE 338.13
130mm / 5"



HEGAR - BAUMGARTNER
AE 340.14
140mm / 5¹/₂"

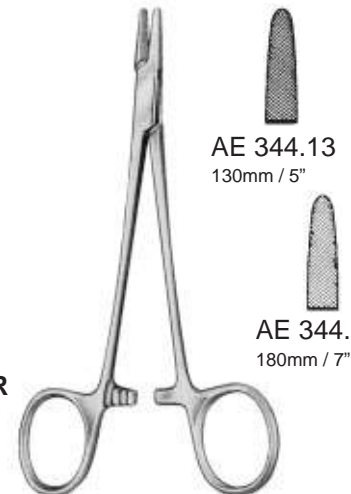

BROWN
AE 344.13 - AE 344.18



CRILE - MURRAY
AE 348.15
150mm / 6"



CRILE - WOOD
AE 350.15 // 150mm / 6"
AE 350.18 // 180mm / 7"



ADSON
AE 360.18
180mm / 7"



METZENBAUM
AE 364.18
180mm / 7"



M.G.H.
MASS.-GENERAL-HOSPITAL
AE 384.17
170mm / 6 1/2"



MAYO - HEGAR
AE 390.14 - AE 390.30



AE 390.14
140mm / 5 1/2"



AE 390.16
160mm / 6 1/2"



AE 390.18
180mm / 7"



AE 390.20
200mm / 8"

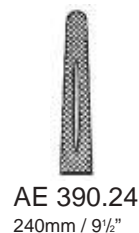

AE 390.24
240mm / 9 1/2"

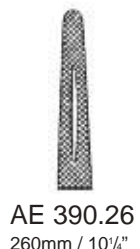

AE 390.26
260mm / 10 1/4"



AE 390.30
300mm / 12"



AE 392.15
150mm / 6"

AE 392.18
180mm / 7"

AE 392.20
200mm / 8"

AE 394.20
200mm / 8"

HEGAR
AE 392.15 - AE 394.20
 Robuste Modelle, *Robust model*
 Modelli robusti, *Modelos robustos*



AE 396.16
160mm / 6 1/2"

AE 396.18
180mm / 7"

AE 396.20
200mm / 8"

Schlankes Modell, *Delicate pattern*
 Modello fino, *Modelo delgado*

MAYO - HEGAR
AE 396.16 - AE 396.20



HEANEY
AE 403.21
210mm / 8 1/4"



JAMISON
AE 404.23
230mm / 9"



MASSON
AE 408.27
270mm / 10 1/2"



FINOCCHIETTO
AE 415.27
270mm / 10½"



WANGENSTEEN
AE 420.27
270mm / 10½"



JOHNSON
AE 437.27
270mm / 10½"



STRATTE
AE 451.23
230mm / 9"



OLSEN - HEGAR
AE 466.14
140mm / 5½"



GILLIES
AE 469.16
160mm / 6½"

CRILE GIORGE, * 1864, † 1943

Professor der Chirurgie an der: "Western Reserve University"
Gründer der "Cleveland Klinik"
Surgical Professor at the "Western Reserve University".
Founder of the "Cleveland Clinic".
Professore di chirurgia alla: "Western Reserve University"
Fondatore della: "Cleveland Clinic"
Profesor de cirugía de la: "Western Reserve University"
Fundador de la: "Cleveland Clinic"



CRILE
AE 500.15
150mm / 6"



MATHIEU
AE 516.17 - AE 516.20



AE 516.14
140mm / 5½"



AE 516.17
170mm / 6¾"



AE 516.20
200mm / 8"



AE 526.14
140mm / 5½"

schlankes Modell, *delicate pattern*,
modello fine, *modelo delgado*

MATHIEU
AE 526.14 - AE 526.17



AE 526.17
170mm / 6¾"



BOYNTON
AE 530.12
120mm / 4¾"



TOENNIS
AE 574.18
180mm / 7"



LICHTENBERG
AE 576.20
200mm / 8"



CT - ORO



NADELHALTER
NEEDLE HOLDERS
PORTAGHI
PORTA - AGUJAS



CT - ORO

C = carbide T = tungsten

C = carburo T = tungsteno

Tungsten oder Wolfram ist ein metallisches Element, welches im Jahre 1783 durch den schwedischen Chemiker Karl Wilhelm Scheele entdeckt wurde.

Elementsymbol = W, Ordnungszahl = 74, Atomgewicht = 183,86, Schmelzpunkt liegt bei ca. 3380°C, also höher als bei allen anderen bekannten Metallen, der Siedepunkt liegt bei 5500°C.

In Legierung mit metallischen Carbiden liegt die Härte annähernd beim Diamanten.

Tungsten Carbide ist das härteste von menschenhand geschaffene Metall.

Tungsten or Wolfram is a metal element that was discovered in 1783 by the Swedish chemist Karl Wilhelm Scheele.

Element symbol = W, Ident. Number = 74, Atom weight = 183,86, Melting point is approx. 3380°C, (higher than all other know metals), boiling point is 5500°C.

When combined as an alloy with metal carbides, it achieves nearly diamond hardness.

Tungsten Carbide is the hardes man-made material.

Tungsteno o Wolfram é un elemento metallico, che fu scoperto nell'anno 1783 dal Chimico svedese Karl Wilhelm Scheele.

Simbolo d'elemento = W, numero ordinale = 74, peso atomico = 183,86, il punto di fusione si trova a ca. 3380°C, quindi piú alto di tutti gli altri metalli conosciuti, il punto d'ebollizione si trova a 5500°C.

Il tungsteno in lega con il carburo raggiunge un grado di durezza vicino a quello del diamante.

Carburo di tungsteno é la lega di metallo piú dura fino ad ora sviluppata da mani umane.

Tungsteno o Wolfram es un elemento metálico, que fue descubierto en el ano 1783 por el químico sueco Karl Wilhelm Scheele.

Símbolo del elemento = W, número ordinal = 74, peso atómico 183,86, el punto de fusión es aproximadamente de 3380°C, es decir más alto que el de todos los metales conocidos, el punto de ebullición es aproximadamente 5500°C.

En aleación con carburos metálicos la dureza es parecida a la del diamante.

Carburo de tungsteno es el metal más duro creado por el hombre.

CT - ORO

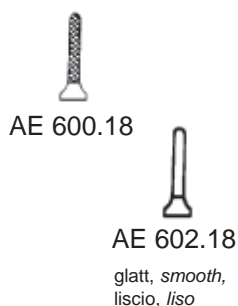
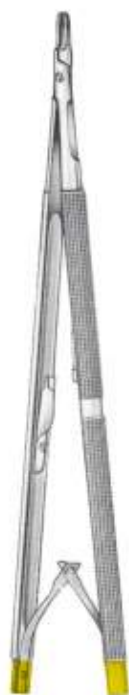

HEPP - SCHEIDEL
AE 600.18 - AE 602.18
180mm / 7"

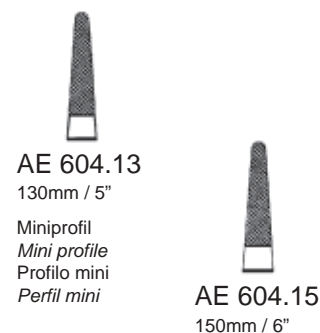

AE 604.13 - AE 604.15
Mit Durchdrückaste, auch für Linkshändler
With automatic release ratchet, also for lefthandler
Con cremagliera automatica, anche per mancini
Con cremallera automática, también para mano izquierda

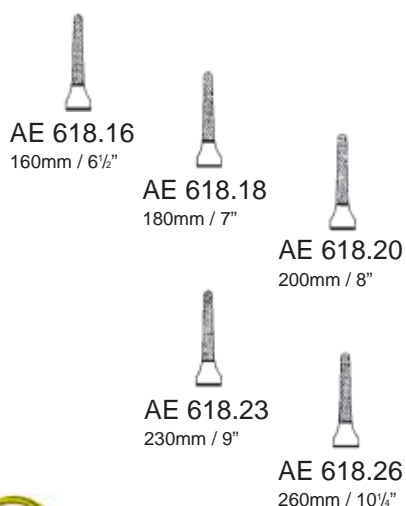

Mikroprofil, *Micro profile*,
Perfil micro, *Perfil micro*

DIETRICH
AE 618.16 - AE 618.26

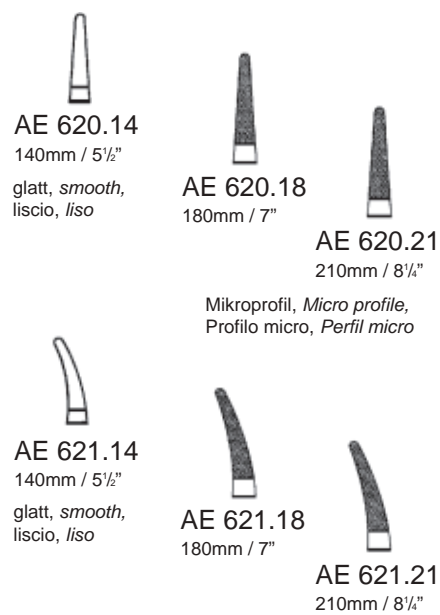

CASTROVIEJO
AE 620.14 - AE 621.21

CT - ORO



CASTROVIEJO
AE 622.14
140mm / 5½"



ARRUGA
AE 622.16 - AE 623.16
160mm / 6½"

AE 622.16

AE 623.16

Miniprofil, *Mini profile,*
Profilo mini, *Perfil mini*



CASTROVIEJO
AE 624.13
130mm / 5"

glatt, *smooth,*
liscio, *liso*



BARRAQUER
AE 626.13
130mm / 5"
Mit Sperre, *with ratchet,*
con cremagliera, *con cremallera*

glatt, *smooth,*
liscio, *liso*



BARRAQUER
AE 628.13
130mm / 5"
Ohne Sperre, *without ratchet,*
senza cremagliera, *sin cremallera*

glatt, *smooth,*
liscio, *liso*

CT - ORO



glatt, *smooth*
liscio, *liso*

WEBSTER
AE 630.13
130mm / 5"



CONVERSE
AE 631.13
130mm / 5"



Miniprofil
Mini profile
Profilo mini
Perfil mini

DERF
AE 632.12
120mm / 4 3/4"



AE 634.13
130mm / 5"

AE 634.14
140mm / 5 1/2"

Miniprofil, *Mini profile*,
Profilo mini, *Perfil mini*

HEGAR - BAUMGARTNER
AE 634.13 - AE 634.14



KILNER
AE 635.13
130mm / 5"



AE 636.13
glatt, *smooth*,
liscio, *liso*

AE 637.13
Miniprofil
Mini profile
Profilo mini
Perfil mini

HALSEY
AE 636.13 - AE 637.13
130mm / 5"



glatt, *smooth*,
liscio, *liso*

WEBSTER
AE 637.12
120mm / 4 3/4"

CT - ORO



Miniprofil
Mini profile
Profilo mini
Perfil mini

CRILE - WOOD

- AE 638.15 // 150mm / 6"
- AE 638.18 // 180mm / 7"
- AE 638.20 // 200mm / 8"
- AE 638.22 // 220mm / 8 3/4"



AE 639.18
180mm / 7"



AE 639.20
200mm / 8"



AE 639.23
230mm / 9"

CRILE - WOOD
AE 639.18 - AE 639.23

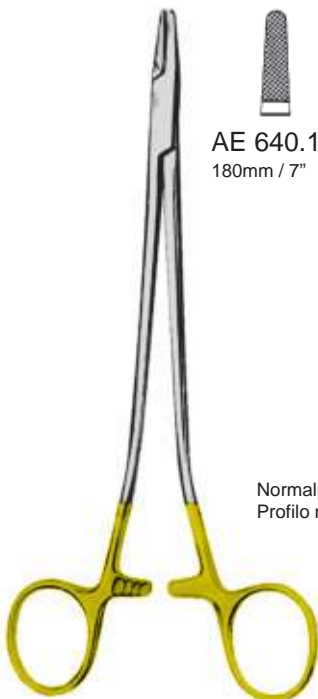

AE 640.18
180mm / 7"



AE 640.20
200mm / 8"



AE 640.26
260mm / 10 1/4"

Normalprofil, normal profile,
Profilo normale, Perfil normal

SAROT
AE 640.18 - AE 640.26

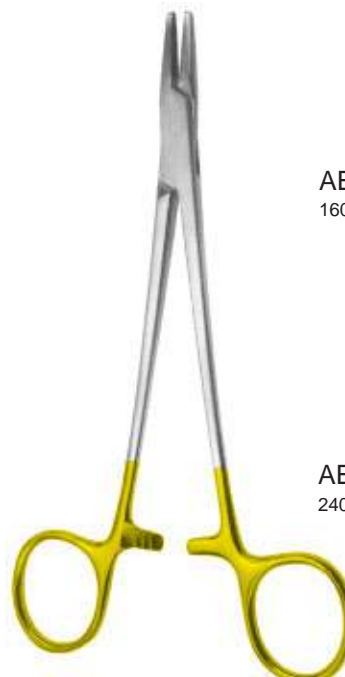

AE 642.16
160mm / 6 1/2"



AE 642.18
180mm / 7"



AE 642.20
200mm / 8"



AE 642.24
240mm / 9 1/2"



AE 642.26
260mm / 10 1/4"



AE 642.30
300mm / 12"

Normalprofil, normal profile,
Profilo normale, Perfil normal

MAYO - HEGAR
AE 642.16 - AE 642.30

CT - ORO

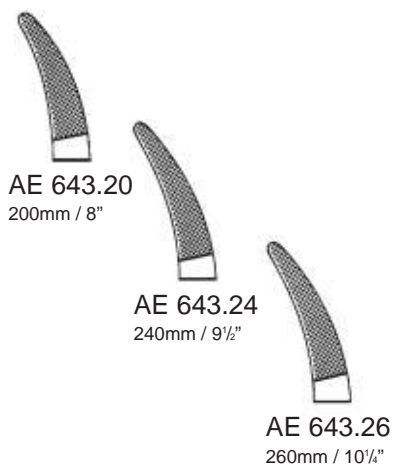

Normalprofil, *Normal profile*,
Profilo normale, *Perfil normal*

MAYO - HEGAR (HEANEY)
AE 643.20 - AE 643.26

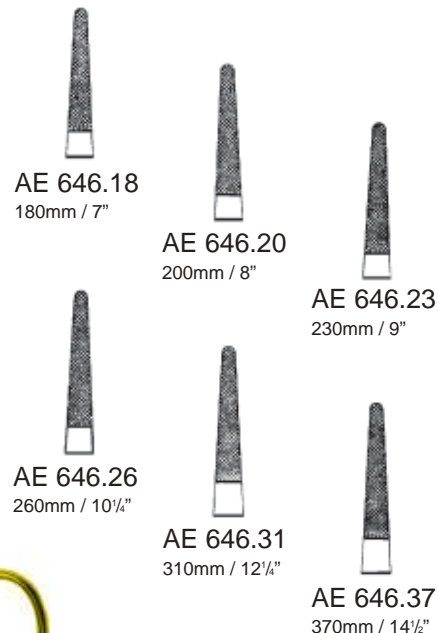

Miniprofil, *Mini profile*,
Profilo mini, *Perfil mini*

DE BAKEY
AE 646.18 - AE 646.37

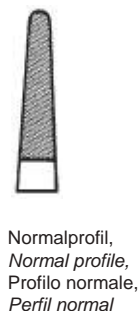

Normalprofil,
Normal profile,
Profilo normale,
Perfil normal

MASSON
AE 648.27
270mm / 10 1/2"

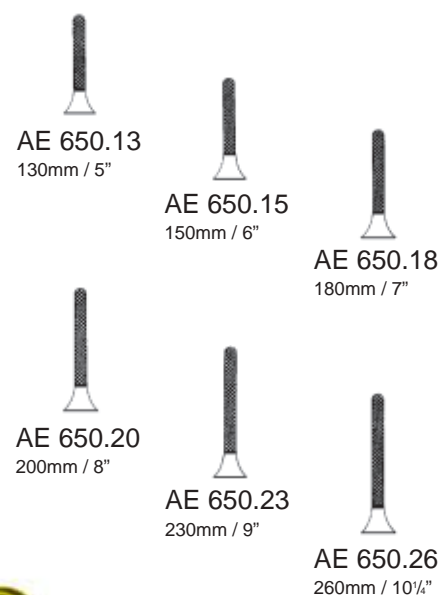

Miniprofil, *Mini profile*,
Profilo mini, *Perfil mini*

RYDER
AE 650.13 - AE 650.26

CT - ORO

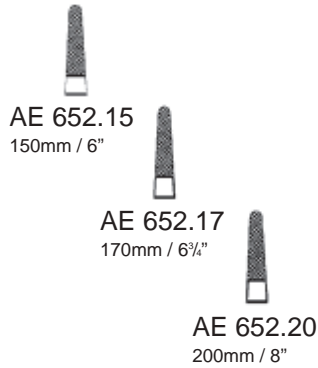
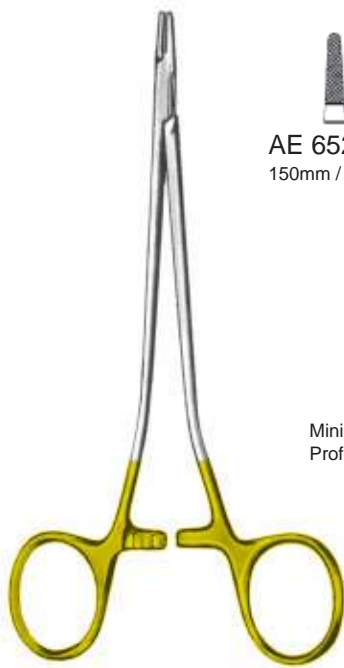

Miniprofil, *Mini profile*,
Profilo mini, *Perfil mini*

AE 652.15 - AE 652.20



Normalprofil
Normal profile
Profilo normale
Perfil normal

FINOCCHIOETTO
AE 653.27
270mm / 10 1/2"

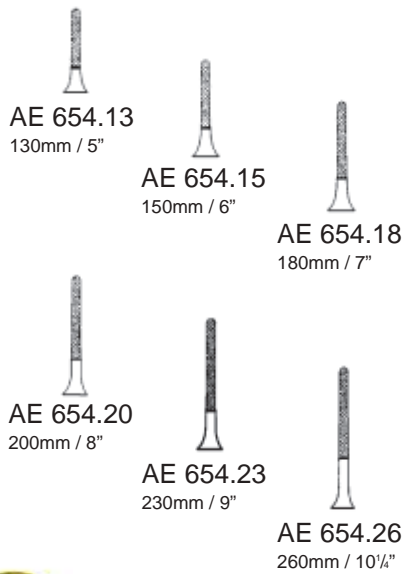

Mikroprofil, *Micro profile*,
Profilo micro, *Perfil micro*

RYDER - VASCULAR
AE 654.13 - AE 654.26

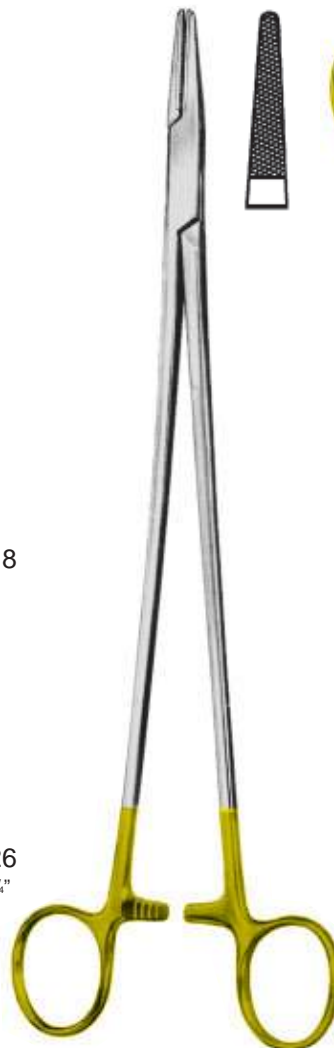

WANGENSTEIN
AE 656.27
270mm / 10 1/2"

CT - ORO



AE 658.14
140mm / 5½"

AE 658.18
180mm / 7"

AE 658.20
200mm / 8"

AE 658.23
230mm / 9"

Mikroprofil, *Micro profile*,
Profilo micro, *Perfil micro*

HEGAR - VASCULAR
AE 658.14 - AE 658.23



AE 659.20
200mm / 8"

AE 659.24
240mm / 9½"

AE 659.26
260mm / 10¼"

AE 659.28
280mm / 11"

Normalprofil, *normal profile*,
Profilo normale, *Perfil normal*

BOZEMANN
AE 659.20 - AE 659.28



AE 662.20
200mm / 8"

AE 662.24
240mm / 9½"

Normalprofil, *Normal profile*,
Profilo normale, *Perfil normal*

HEGAR
AE 662.20 - AE 662.24



AE 665.22
220mm / 8¾"

AE 665.23
230mm / 9"

Normalprofil
Normal profile
Profilo normale
Perfil normal

STRATTE
AE 665.22 - AE 665.23

CT - ORO



AE 666.00
AE 668.00
140mm / 5½"

AE 666.02
AE 668.02
180mm / 7"

AE 666.03
AE 668.03
200mm / 8"

AE 666.04
AE 668.04
230mm / 9"

AE 666.05
AE 668.05
260mm / 10¼"

MICROVASCULAR
AE 666.00 - AE 666.05

Mikroprofil, *Micro profile*,
Profilo micro, *Perfil micro*



MICROVASCULAR
AE 668.00 - AE 668.05

glatt, *smooth*, liscio, *liso*



AE 672.14
140mm / 5½"

AE 672.17
170mm / 6¾"

AE 672.18
180mm / 7"

Normalprofil, *Normal profile*,
Profilo normale, *Perfil normal*

OLSEN - HEGAR
AE 672.14 - AE 672.18



Miniprofil
Mini profile
Profilo mini
Perfil mini

GILLIES - MINI
AE 673.15
150mm / 6"



Normalprofil
Normal profile
Profilo normale
Perfil normal

GILLIES
AE 673.16
160mm / 6½"

CT - ORO

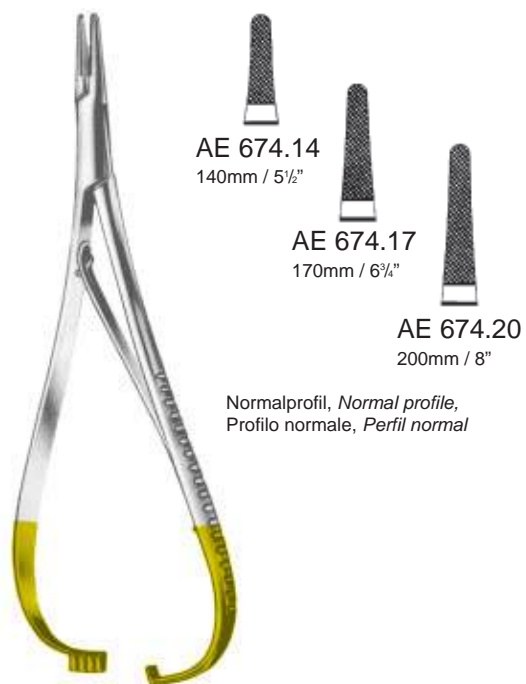

AE 674.14
140mm / 5 1/2"

AE 674.17
170mm / 6 3/4"

AE 674.20
200mm / 8"

Normalprofil, *Normal profile*,
Profilo normale, *Perfil normal*

MATHIEU - KOCHER
AE 674.14 - AE 674.20



AE 676.14
140mm / 5 1/2"

AE 676.17
170mm / 6 3/4"

AE 676.20
200mm / 8"

Normalprofil, *Normal profile*,
Profilo normale, *Perfil normal*

MATHIEU
AE 676.14 - AE 676.20

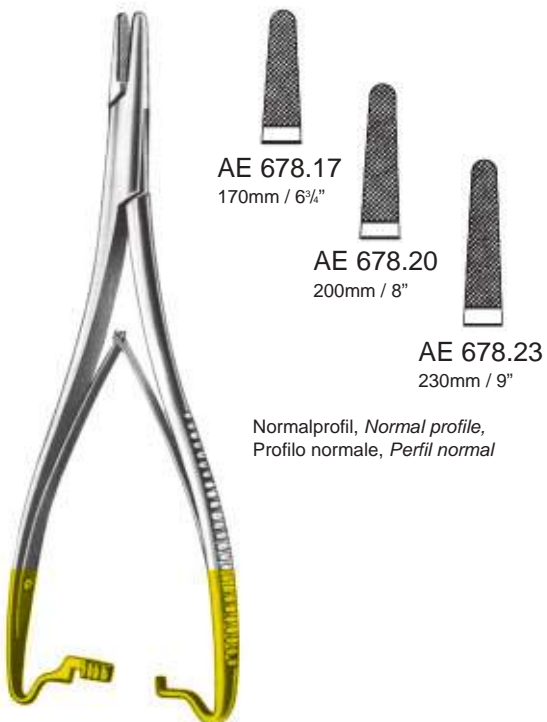

AE 678.17
170mm / 6 3/4"

AE 678.20
200mm / 8"

AE 678.23
230mm / 9"

Normalprofil, *Normal profile*,
Profilo normale, *Perfil normal*

MATHIEU
AE 678.17 - AE 678.23



AE 679.17
170mm / 6 3/4"

AE 679.19
190mm / 7 1/2"

Normalprofil, *Normal profile*,
Profilo normale, *Perfil normal*

METZENBAUM
AE 679.17 - AE 679.19

CT - ORO



Normalprofil
Normal profile
Profilo normale
Perfil normal

TOENNIS
AE 684.18
180mm / 7"



Normalprofil
Normal profile
Profilo normale
Perfil normal

LICHTENBERG
AE 686.20
200mm / 8"



AE 692.18
180mm / 7"



AE 692.20
200mm / 8"



AE 692.23
230mm / 9"

Normalprofil, Normal profile,
Profilo normale, Perfil normal

LANGENBECK
AE 692.18 - AE 692.23



AE 696.20
200mm / 8"



AE 696.23
230mm / 9"

Normalprofil, Normal profile,
Profilo normale, Perfil normal

ZWEIFEL
AE 696.20 - AE 692.23



AE 701.15
Fig. 1



AE 702.15
Fig. 2



AE 703.15
Fig. 3



AE 704.15
Fig. 4

REVERDIN
AE 701.15 - AE 704.15
140mm / 5½"



AE 721.19
Fig. 1



AE 722.19
Fig. 2



AE 723.19
Fig. 3



AE 724.19
Fig. 4

REVERDIN
AE 721.19 - AE 724.19
190mm / 7½"



AE 741.23
 Fig. 1

AE 742.23
 Fig. 2

AE 743.23
 Fig. 3

AE 744.23
 Fig. 4

REVERDIN
AE 741.23 - AE 744.23
 230mm / 9"



AE 775.01



AE 775.02



AE 775.03

AE 775.01 - AE 775.03

Ersatznadeln, allein
Spare needles, only
 Aghi di ricambio, solo
Agujas de repuesto, sueltas

mit 1 Nadel AE 775.01
with 1 needle AE 775.01
 con 1 ago AE 775.01
con 1 aguja AE 775.01

YOUNG
AE 775.21 // 210mm / 8 1/4"
AE 775.25 // 250mm / 10"

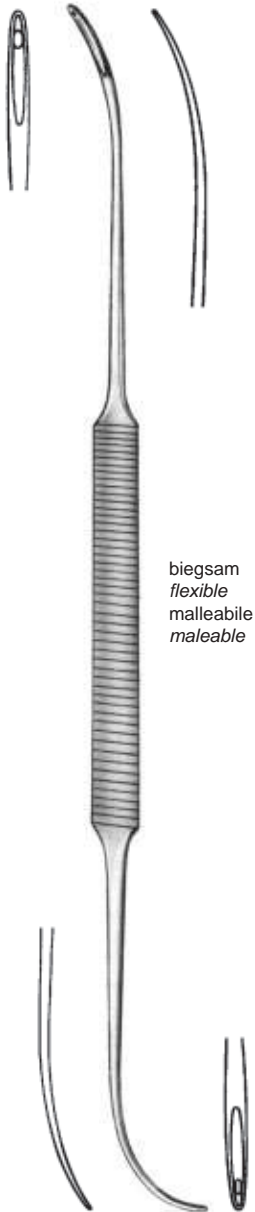

biegsam
flexible
malleabile
malleable

SCHMIEDEN - DICK
AE 813.32
320mm / 12½"



SCHMIEDEN
AE 815.21
210mm / 8¼"



biegsam
flexible
malleabile
malleable

AE 825.20
200mm / 8"



COOPER
AE 832.19
190mm / 7½"

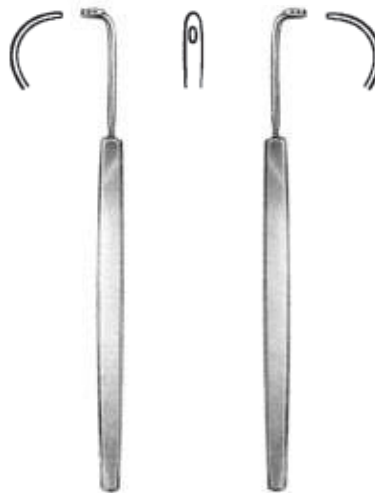

KRONECKER
AE 835.13 **AE 837.13**
130mm / 5" 130mm / 5"

Unterbindungsnadeln
Ligature Needles
Aghi per legatura
Agujas para ligaduras



links gebogen, für die rechte Hand
curved to left, for the right hand
 curva a sinistra, per la mano destra
 curva a izquierda, para la mano derecha

rechts gebogen, für die linke Hand
curved to right, for the left hand
 curva a destra, per la mano sinistra
 curva a derecha, para la mano izquierda

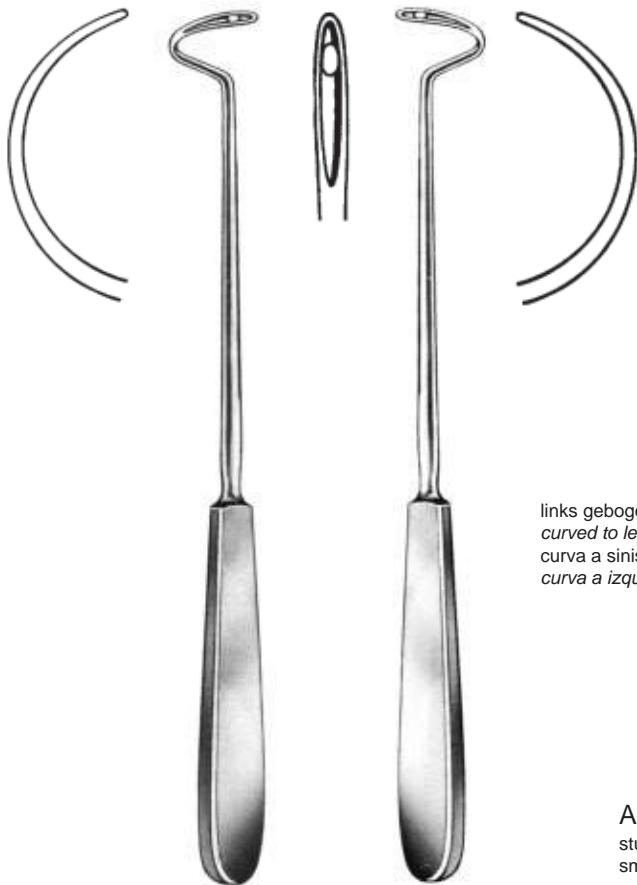

DESCHAMPS
AE 839.24 AE 840.24
 240mm / 9½"

links gebogen, für die rechte Hand
curved to left, for the right hand
 curva a sinistra, per la mano destra
 curva a izquierda, para la mano derecha

rechts gebogen, für die linke Hand
curved to right, for the left hand
 curva a destra, per la mano sinistra
 curva a derecha, para la mano izquierda

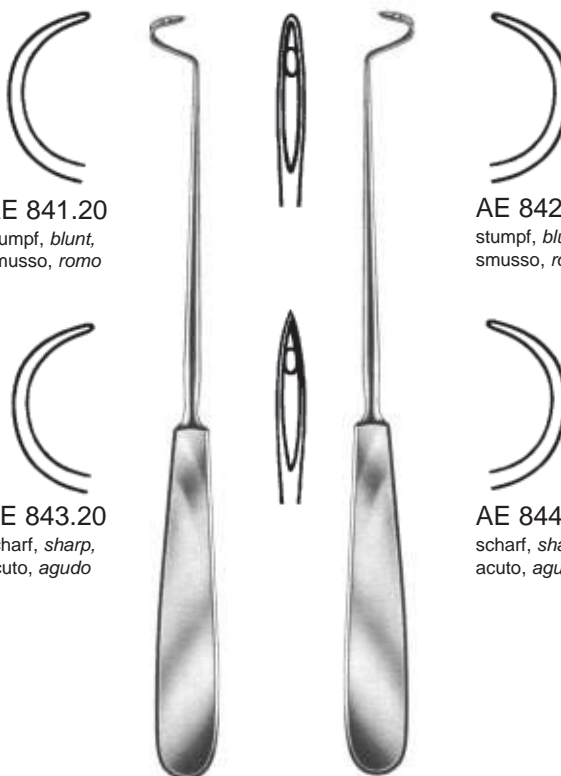

AE 841.20
 stumpf, *blunt*,
 smusso, *romo*

AE 842.20
 stumpf, *blunt*,
 smusso, *romo*

AE 843.20
 scharf, *sharp*,
 acuto, *agudo*

AE 844.20
 scharf, *sharp*,
 acuto, *agudo*

DESCHAMPS
AE 841.20 AE 842.20
AE 843.20 AE 844.20
 200mm / 8"

Unterbindungsnadeln
Ligature Needles
Aghi per legatura
Agujas para ligaduras



links gebogen, für die rechte Hand
curved to left, for the right hand
 curva a sinistra, per la mano destra
 curva a izquierda, para la mano derecha

rechts gebogen, für die linke Hand
curved to right, for the left hand
 curva a destra, per la mano sinistra
 curva a derecha, para la mano izquierda



AE 845.21
 stumpf, *blunt*,
 smusso, *romo*

AE 846.21
 stumpf, *blunt*,
 smusso, *romo*

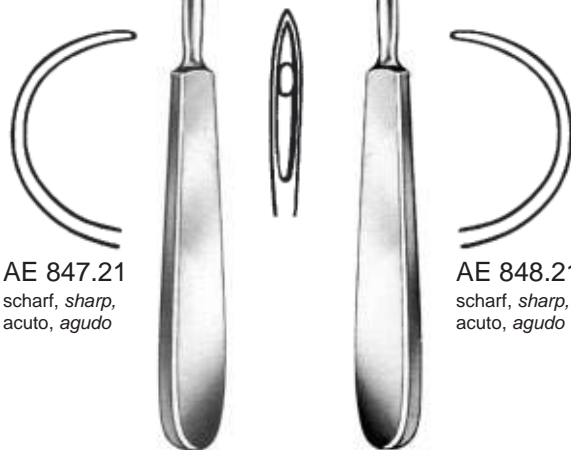

AE 847.21
 scharf, *sharp*,
 acuto, *agudo*

AE 848.21
 scharf, *sharp*,
 acuto, *agudo*

DESCHAMPS

- | | |
|------------------|------------------|
| AE 845.21 | AE 846.21 |
| AE 847.21 | AE 848.21 |
- 210mm / 8 1/4"

links gebogen, für die rechte Hand
curved to left, for the right hand
 curva a sinistra, per la mano destra
 curva a izquierda, para la mano derecha

rechts gebogen, für die linke Hand
curved to right, for the left hand
 curva a destra, per la mano sinistra
 curva a derecha, para la mano izquierda



AE 849.27
 stumpf, *blunt*,
 smusso, *romo*

AE 850.27
 stumpf, *blunt*,
 smusso, *romo*

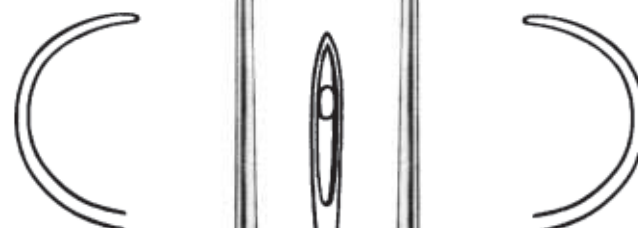

AE 851.27
 scharf, *sharp*,
 acuto, *agudo*

AE 852.27
 scharf, *sharp*,
 acuto, *agudo*

DESCHAMPS

- | | |
|------------------|------------------|
| AE 849.27 | AE 850.27 |
| AE 851.27 | AE 852.27 |
- 270mm / 10 1/2"

Unterbindungsnadeln
Ligature Needles
Aghi per legatura
Agujas para ligaduras



links gebogen, für die rechte Hand
curved to left, for the right hand
 curva a sinistra, per la mano destra
 curva a izquierda, para la mano derecha

rechts gebogen, für die linke Hand
curved to right, for the left hand
 curva a destra, per la mano sinistra
 curva a derecha, para la mano izquierda



AE 853.28
 stumpf, *blunt*,
 smusso, *romo*

AE 854.28
 stumpf, *blunt*,
 smusso, *romo*

DESCHAMPS
AE 853.28 AE 854.28
 280mm / 11"

links gebogen, für die rechte Hand
curved to left, for the right hand
 curva a sinistra, per la mano destra
 curva a izquierda, para la mano derecha

rechts gebogen, für die linke Hand
curved to right, for the left hand
 curva a destra, per la mano sinistra
 curva a derecha, para la mano izquierda

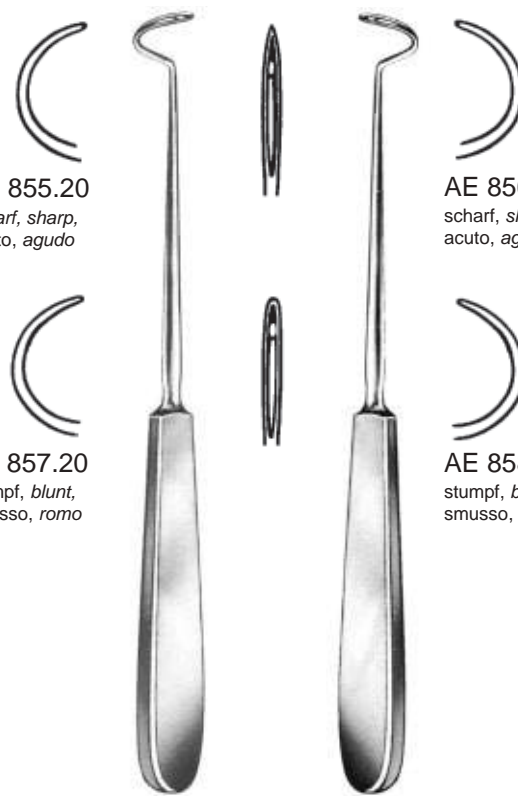

AE 855.20
 scharf, *sharp*,
 aguto, *agudo*

AE 856.20
 scharf, *sharp*,
 acuto, *agudo*

AE 857.20
 stumpf, *blunt*,
 smusso, *romo*

AE 858.20
 stumpf, *bunt*,
 smusso, *romo*

DESCHAMPS
AE 855.20 AE 856.20
AE 857.20 AE 858.20
 200mm / 8"



AE 861.30



AE 862.30



AE 863.30



AE 864.30

BRUNNER
AE 861.30 - AE 862.30
300mm / 12"



BRUNNER
AE 863.30 - AE 864.30
300mm / 12"



KIRSCHNER
AE 865.25
250mm / 10"



AE 866.28
280mm / 11"



MOD. MARTIN
AE 867.25
250mm / 10"



BRUNNER - FERROZELL
AE 868.18 // 180mm / 7"
AE 868.27 // 270mm / 10½"



KIRSCHNER - FERROZELL
AE 869.27
270mm / 10½"



FERROZELL
AE 870.01
190mm / 7½"



AE 870.19
190mm / 7½"



FERROZELL
AE 870.24
240mm / 9½"



SCHMIEDEN
AE 871.19
190mm / 7½"

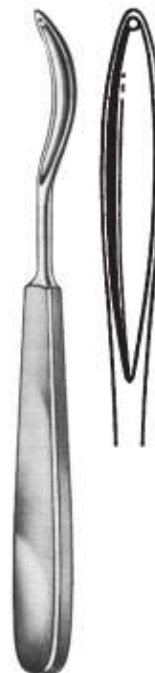

SCHMIEDEN - PAYR
AE 872.19
190mm / 7½"



KÖNIG
AE 875.03
 195mm / 7³/₄"



KÖNIG
AE 875.05
 195mm / 7³/₄"



KÖNIG
AE 875.07
 200mm / 8"



PAYR
AE 877.22
 220mm / 8¹/₄"



PAYR
AE 878.22
 220mm / 8¹/₄"



MOD. WIEN
AE 882.23
 230mm / 9"



AE 886.23
 230mm / 9"



OCHSNER
AE 894.14
140mm / 5½"



LANGE
AE 901.10
100mm / 4"



WACHENFELDT
AE 904.12
120mm / 4¾"



CHILDE
AE 910.18
180mm / 7"



MICHEL
AE 916.12
120mm / 4¾"



WACHENFELDT
AE 918.12
120mm / 4¾"



HEGENBARTH
AE 922.12
120mm / 4¾"



MICHEL
AE 928.12
120mm / 4¾"



MOD. MICHEL
AE 929.12
120mm / 4¾"



COLLIN
AE 934.13
130mm / 5"



RICHTER - HEATH
AE 935.14
140mm / 5½"

Wundklammern, Wundklammerbesteck
Wound Clips, Suture Set
Agrafe, Set per sutura
Agrafes, Estuches para suturas



Packung á 1000 Stück
Packages of 1000 pieces
Pacchetto di 1000 pezzi
Paquetitos de 1000 piezas

AE 940.01 // 7,5 x 1,75 mm
AE 940.02 // 11 x 2 mm
AE 940.04 // 12 x 3 mm
AE 940.05 // 14 x 3 mm
AE 940.06 // 16 x 3 mm
AE 940.07 // 18 x 3 mm
AE 940.08 // 20 x 3 mm
AE 940.09 // 22 x 3 mm

MICHEL
AE 940.01 - AE 940.09

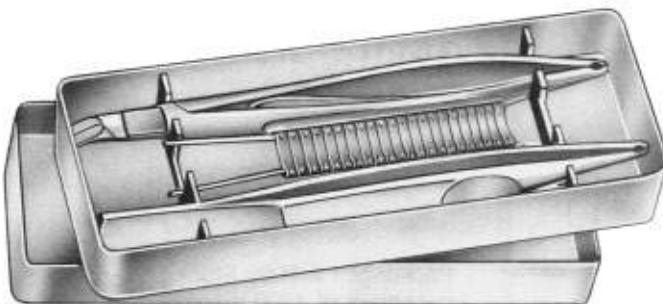

MICHEL
AE 952.00
130 x 45 x 18 mm

Wundklammerbesteck, bestehend aus:
1 Wundklammerzange, Michel AE 928.12
1 Wundrand-Faßspinzette Wachenfeldt mit Klammerhalter, AE 904.12
50 Wundklammern Michel

Suture set, consisting of:
1 clip applying forceps Michel AE 928.12
1 wound grasping forceps Wachenfeldt with clip holder AE 904.12
50 wound clips Michel

Set per sutura composto da:
1 pinza per agrafe Michel, AE 928.12
1 pinza per avvicinare i margini della ferita con porta-agrafe di Wachenfeldt AE 904.12
50 agrafes di Michel

Estuche de suturas compuesto de:
1 pinza para agrafes Michel AE 928.12
1 pinza para unir bordes de herida Wachenfeldt con soporte-clip AE 904.12
50 agrafes de Michel





GEWEBE- UND ORGANFAßZANGEN
TISSUE AND ORGAN HOLDING FORCEPS
PINZE PER AFFERRARE TESSUTI ED ORGANI
PINZAS PARA TEJIDOS Y ÓRGANOS

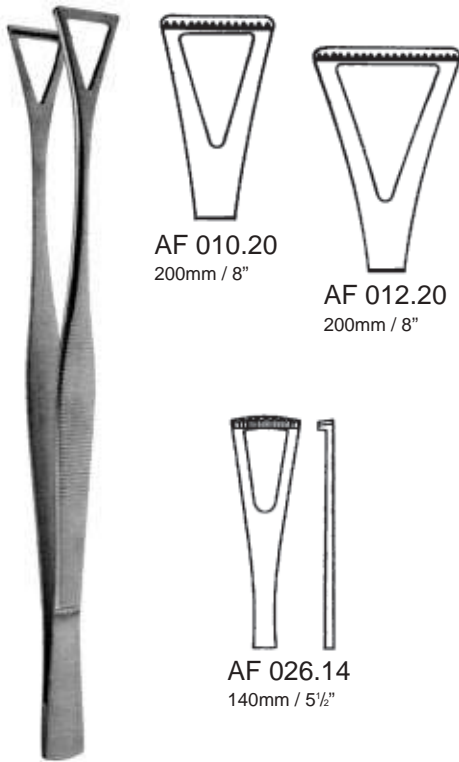

COLLIN - DUVAL
 AF 010.20 - AF 026.14



BABY - ALLIS
 AF 130.12
 120mm / 4¾"
 4:5 Zähne, *Teeth, Denti, Dientes*

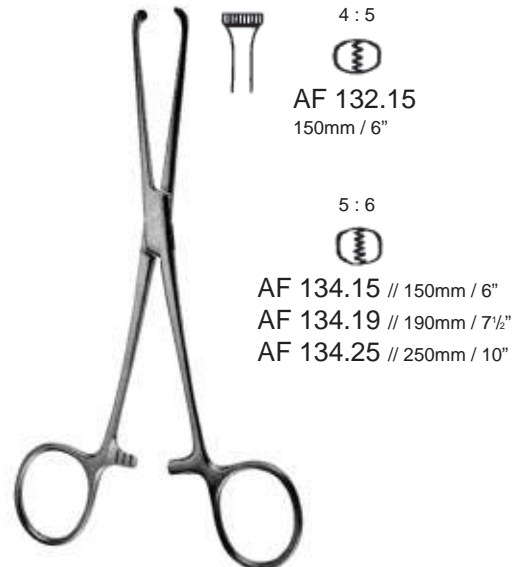

ALLIS
 AF 132.15 - AF 134.25



ALLIS - ADAIR
 AF 138.15
 150mm / 6"



BOYS - ALLIS
 AF 142.15
 150mm / 6"



JUDD - ALLIS
 AF 148.15 // 150mm / 6"
 AF 148.19 // 190mm / 7½"



THOMS - ALLIS
AF 150.20
200mm / 8"



ALLIS
AF 154.20
200mm / 8"

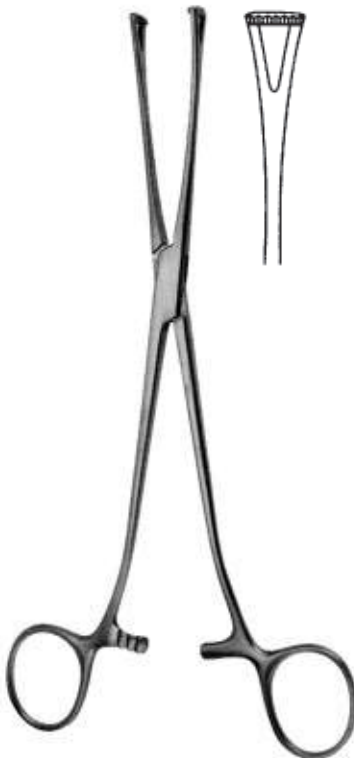

LOCKWOOD
AF 170.20
200mm / 8"



WILLIAMS
AF 186.16
160mm / 6½"

CT - ORO



AF 190.16
160mm / 6½"

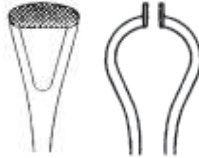

AF 190.20
200mm / 8"



BABCOCK
AF 190.16 - AF 190.20

DUVAL
AF 206.20
200mm / 8"

BABCOCK, WILLIAM WAYNE, * 1872, † 1963

Chirurg in Philadelphia, *Surgeon in Philadelphia*
 Cirujano en Philadelphia, *Cirujano en Philadelphia*



AF 192.16
160mm / 6½"



AF 192.18
180mm / 7"



AF 192.20
200mm / 8"



AF 192.24
240mm / 9½"

BABCOCK
AF 192.16 - AF 192.24

ATRAUMATIC



AF 196.16
160mm / 6½"



AF 196.20
200mm / 8"

BABCOCK - ATRAUMATIC
AF 196.16 - AF 196.20

TUFFIER THÉODORE, * 1857, † 1929

Professor an der Fakultät der Medizin. War einer der ersten der sich mit der Lunge-, Herz- und Gefäßchirurgie konfrontierte.

Medical Professor on the Medical Faculty of the Universit of Beaujou (F). Was one of the first surgeons to concerned himself with lung, heart and vessel surgery.

Professore ordinario alla Facoltà di Medicina. Fu tra i primi che affrontò la chirurgia del polmone, del cuore e dei vasi.

Profesor de la Facultad de Medicina. Fue uno de los primeros en afrontar la cirugía de pulmón, de corazón y vasos.

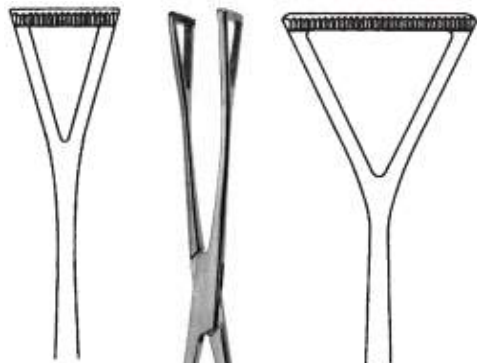

AF 210.18
180mm / 7"

AF 212.20
200mm / 8"

AF 210.20
200mm / 8"

AF 212.23
230mm / 9"



DUVAL
AF 210.18 - AF 212.23



CHAPUT
AF 256.13
130mm / 5"



TUFFIER
AF 258.13
130mm / 5"



COLLIN
AF 268.14
140mm / 5½"

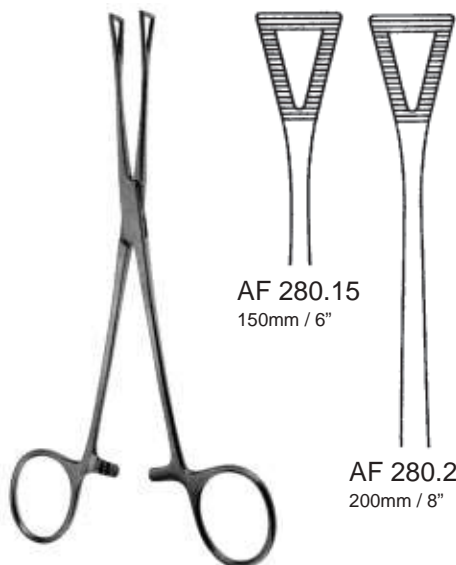

AF 280.15
150mm / 6"

AF 280.20
200mm / 8"

PENNINGTON
AF 280.15 - AF 280.20



LOVELACE
AF 286.20
200mm / 8"



LOVELACE
AF 287.20
200mm / 8"

ATRAUMATIC

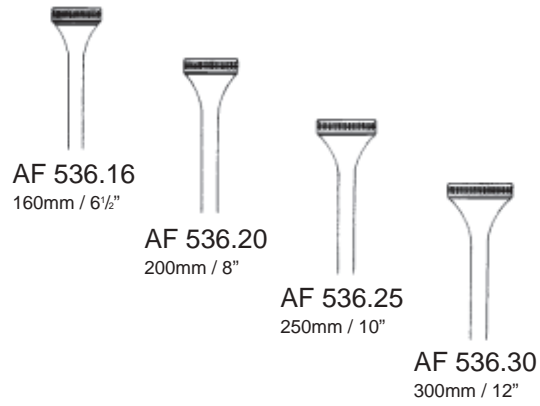
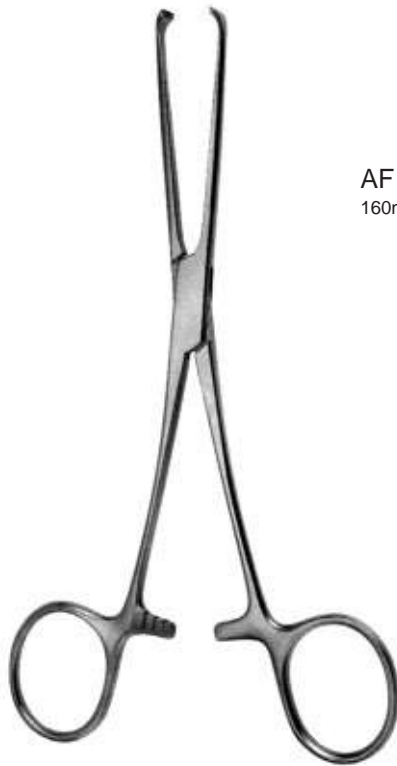

ALLIS - ATRAUMATIC
 AF 536.16 - AF 536.30



SCHEIBE
 AF 540.18 - AF 540.23

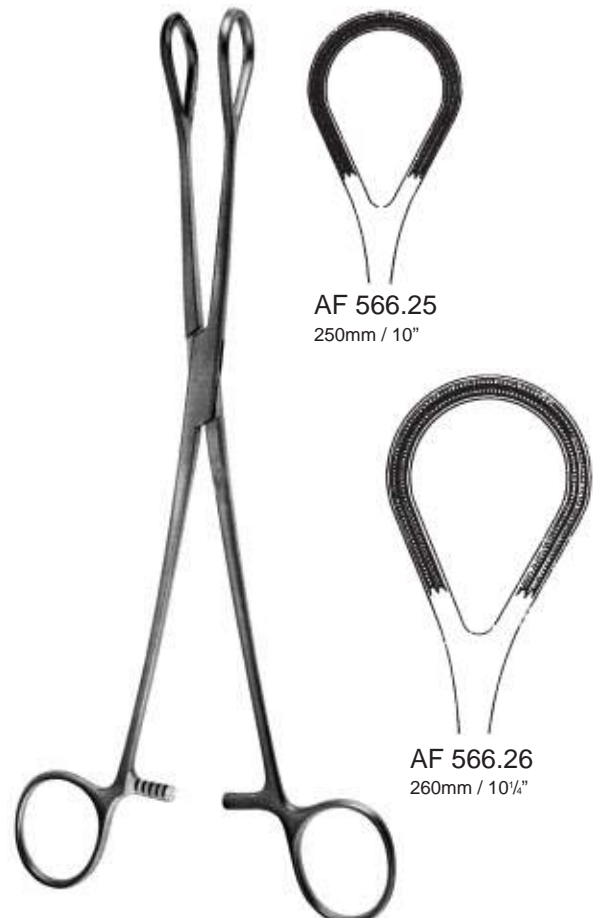

ATRAUMATIC
 AF 566.25 - AF 566.26



POZZI
AF 618.26
260mm / 10¹/₄"



SCHROEDER
AF 622.25
250mm / 10"

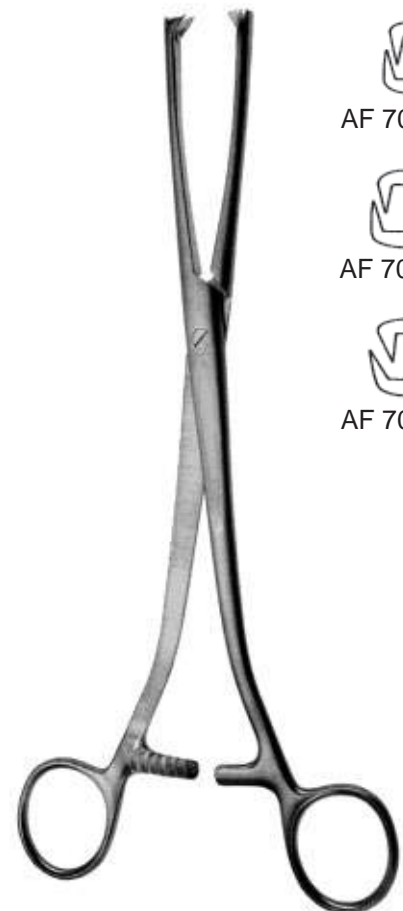

MUSEUX
AF 702.24 - AF 706.24
240mm / 9¹/₂"



AF 702.24



AF 704.24



AF 706.24



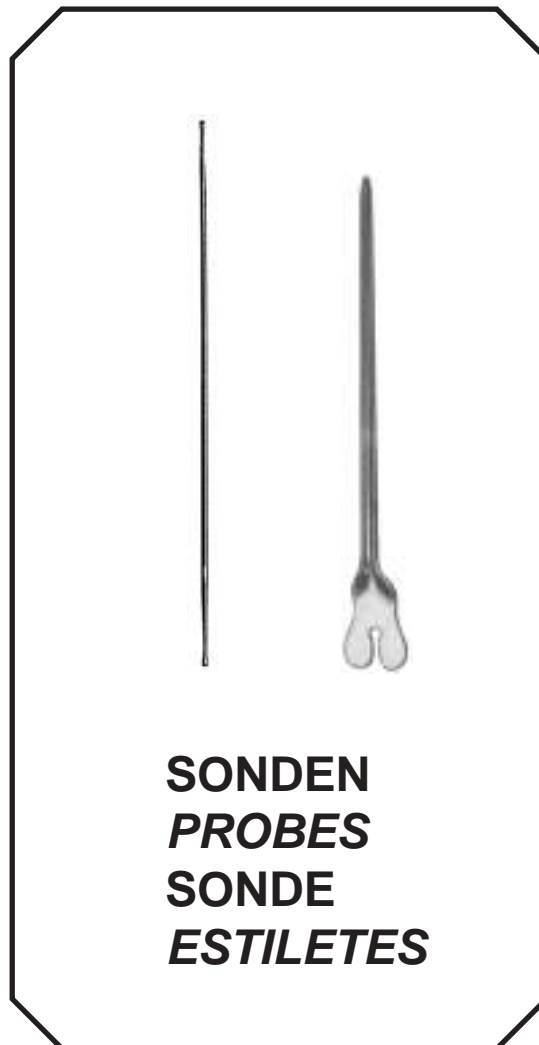

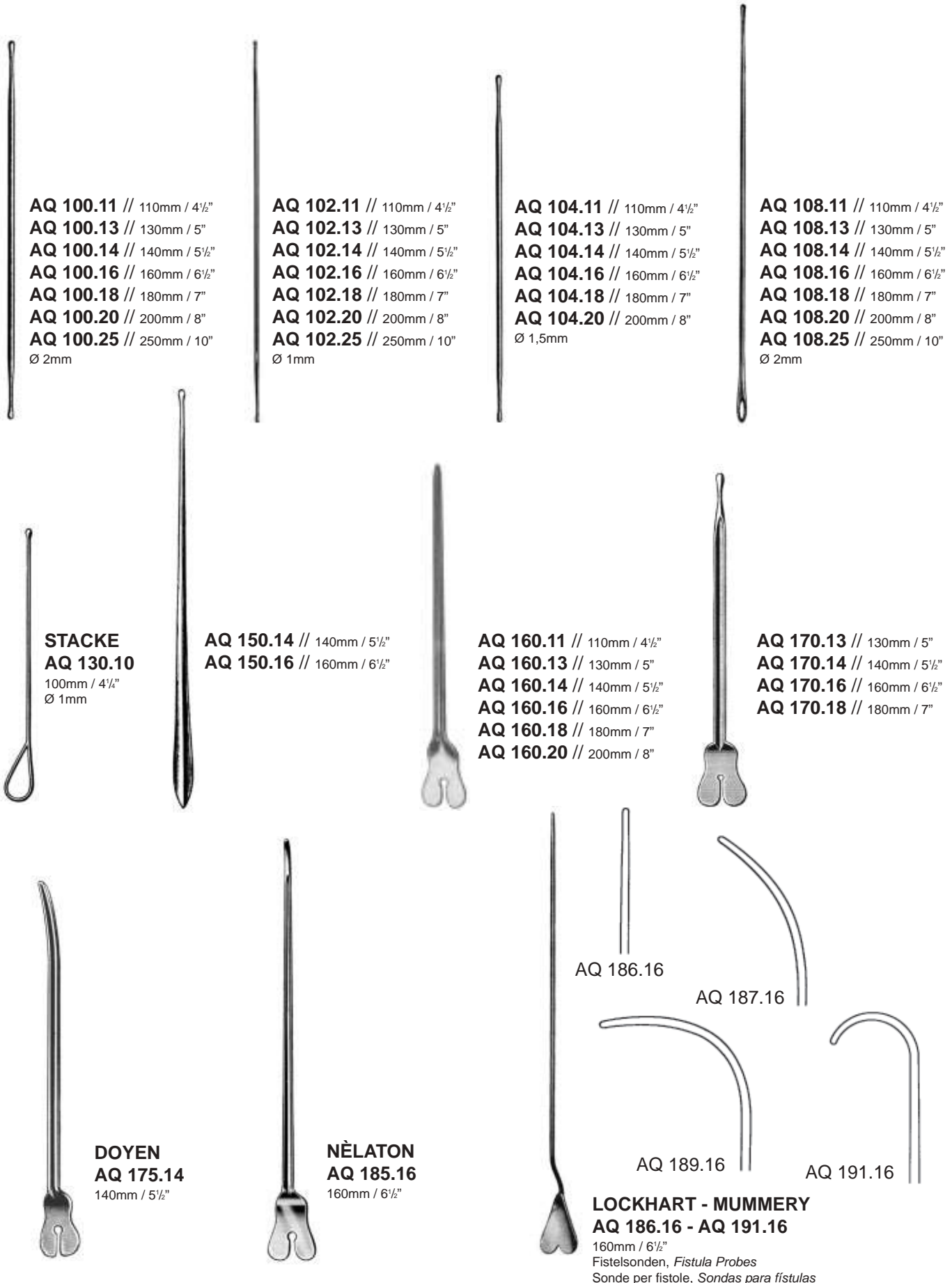

AQ 100.11 // 110mm / 4½"
AQ 100.13 // 130mm / 5"
AQ 100.14 // 140mm / 5½"
AQ 100.16 // 160mm / 6½"
AQ 100.18 // 180mm / 7"
AQ 100.20 // 200mm / 8"
AQ 100.25 // 250mm / 10"
 Ø 2mm

AQ 102.11 // 110mm / 4½"
AQ 102.13 // 130mm / 5"
AQ 102.14 // 140mm / 5½"
AQ 102.16 // 160mm / 6½"
AQ 102.18 // 180mm / 7"
AQ 102.20 // 200mm / 8"
AQ 102.25 // 250mm / 10"
 Ø 1mm

AQ 104.11 // 110mm / 4½"
AQ 104.13 // 130mm / 5"
AQ 104.14 // 140mm / 5½"
AQ 104.16 // 160mm / 6½"
AQ 104.18 // 180mm / 7"
AQ 104.20 // 200mm / 8"
 Ø 1,5mm

AQ 108.11 // 110mm / 4½"
AQ 108.13 // 130mm / 5"
AQ 108.14 // 140mm / 5½"
AQ 108.16 // 160mm / 6½"
AQ 108.18 // 180mm / 7"
AQ 108.20 // 200mm / 8"
AQ 108.25 // 250mm / 10"
 Ø 2mm

STACKE
AQ 130.10
 100mm / 4½"
 Ø 1mm

AQ 150.14 // 140mm / 5½"
AQ 150.16 // 160mm / 6½"

AQ 160.11 // 110mm / 4½"
AQ 160.13 // 130mm / 5"
AQ 160.14 // 140mm / 5½"
AQ 160.16 // 160mm / 6½"
AQ 160.18 // 180mm / 7"
AQ 160.20 // 200mm / 8"

AQ 170.13 // 130mm / 5"
AQ 170.14 // 140mm / 5½"
AQ 170.16 // 160mm / 6½"
AQ 170.18 // 180mm / 7"

DOYEN
AQ 175.14
 140mm / 5½"

NÉLATON
AQ 185.16
 160mm / 6½"

AQ 186.16

AQ 187.16

AQ 189.16

AQ 191.16

LOCKHART - MUMMERY
AQ 186.16 - AQ 191.16
 160mm / 6½"
 Fistelsonden, *Fistula Probes*
 Sonde per fistole, *Sondas para fistulas*

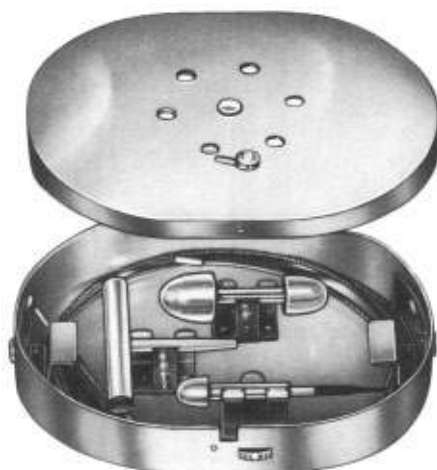

NABATOFF
AQ 250.00

135 x 100 x 25mm

Krampfader-Besteck in Metalletui
 Varicose vein probe set in metal case
 Astuccio per varici in scatola di metallo
 Juego para várices en estuche de metal

Ersatzteile, *Spare parts,*
 Pezzi di ricambio, *Piezas de repuesto*

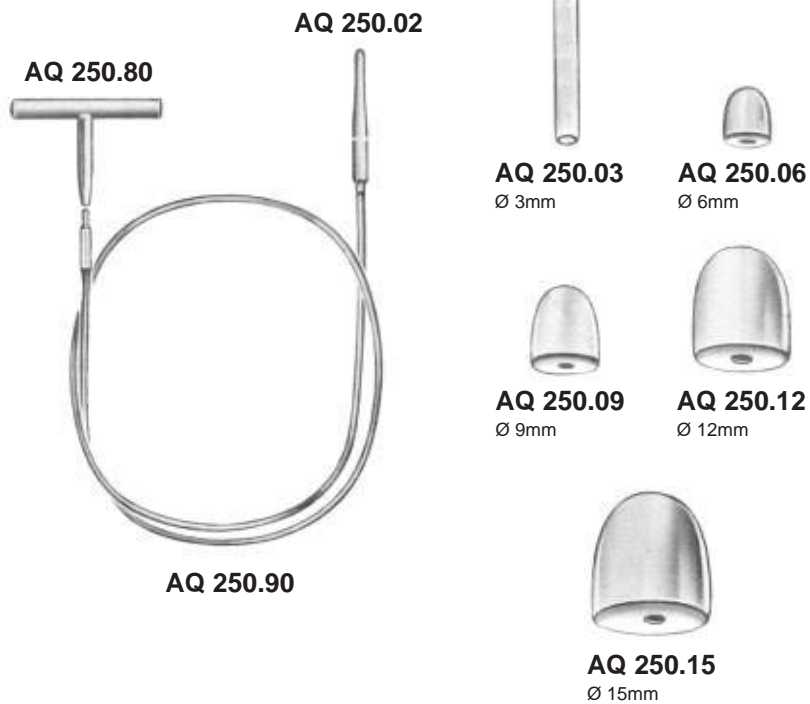

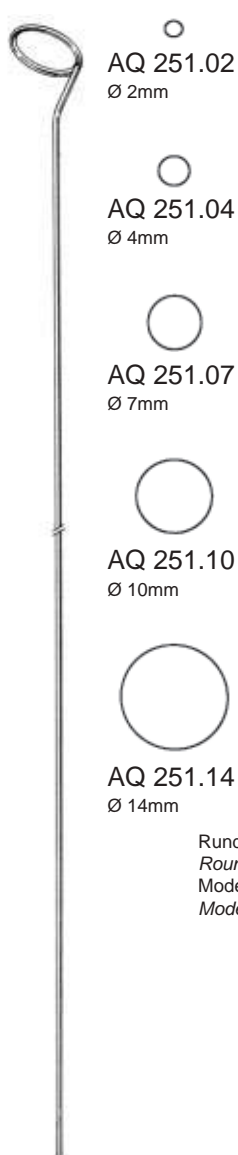

AQ 251.02
Ø 2mm

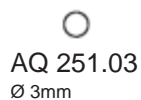

AQ 251.03
Ø 3mm

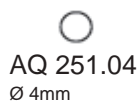

AQ 251.04
Ø 4mm



AQ 251.06
Ø 6mm

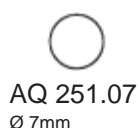

AQ 251.07
Ø 7mm



AQ 251.08
Ø 8mm



AQ 251.10
Ø 10mm



AQ 251.12
Ø 12mm



AQ 251.14
Ø 14mm

Rundes Modell
Round Model
Modello rotondo
Modelo redondo

VOLLMAR
AQ 251.02 - AQ 251.14
 500mm / 20"



AQ 251.30
 120mm / 4 3/4"

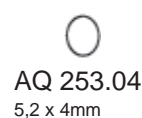

AQ 253.04
5,2 x 4mm



AQ 253.05
6,5 x 5mm



AQ 253.06
7,8 x 6mm



AQ 253.07
9 x 7mm



AQ 253.08
10,5 x 8mm



AQ 253.09
11,5 x 9mm

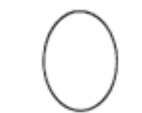

AQ 253.10
13 x 10mm

Ovales Modell
Oval Model
Modello ovale
Modelo oval

VOLLMAR
AQ 253.04 - AQ 253.10
 500mm / 20"



MOD. CEATEC
AQ 410.12 // 120mm / 4 3/4"
AQ 410.14 // 140mm / 5 1/2"
AQ 410.16 // 160mm / 6 1/2"
AQ 410.18 // 180mm / 7"
 Ø 1,2mm



FARREL (LATHBURY - UEBE)
AQ 420.12 // 120mm / 4 3/4" / Ø 0,9mm
AQ 420.14 // 140mm / 5 1/2" / Ø 0,9mm
AQ 420.16 // 160mm / 6 1/2" / Ø 1,1mm
AQ 420.18 // 180mm / 7" / Ø 1,2mm
AQ 420.23 // 230mm / 9" / Ø 1, mm

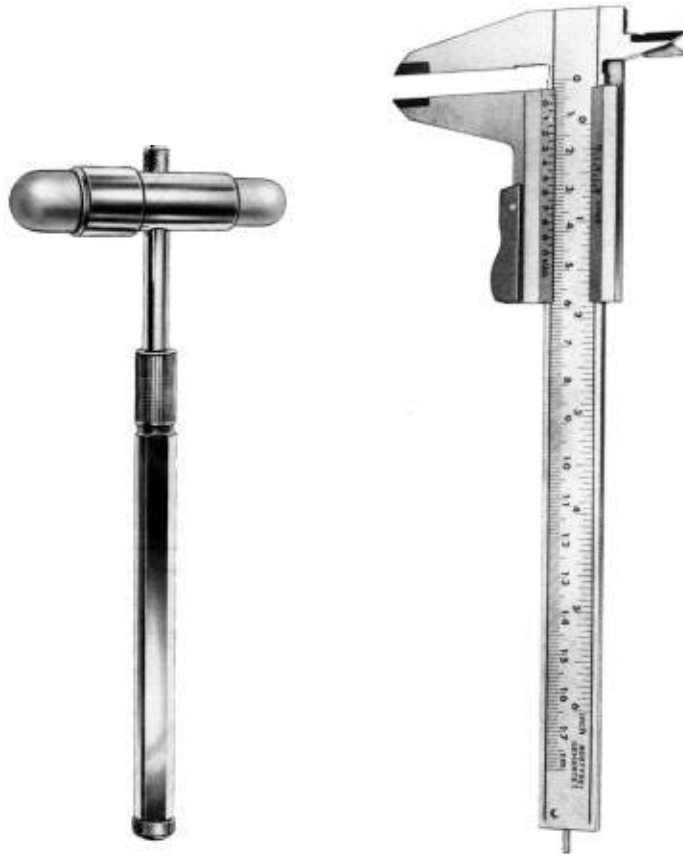

DIAGNOSTIK, MESSINSTRUMENTE
DIAGNOSTICS, MEASURING INSTRUMENTS
DIAGNOSTICA, STRUMENTI PER MISURARE
DIAGNÓSTICO, INSTRUMENTAL PARA MEDIR



RABINER
AQ 150.23
 230mm / 9"
 Ø 40mm



BUCK
AQ 155.18
 180mm / 7"

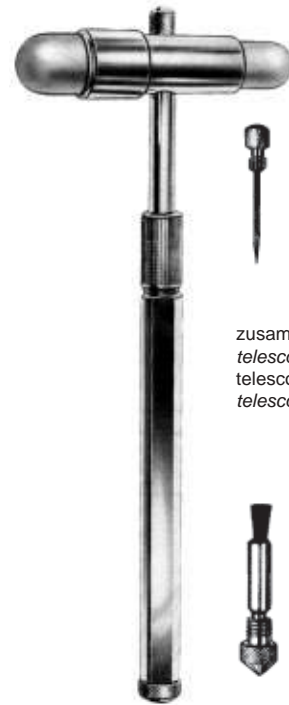

BUCK
AQ 156.18
 180mm / 7"

zusammenschiebbar
telescopic
telescopico
telescópico



DÈJERINE
AQ 184.20
 200mm / 8"



DÈJERINE
AQ 185.21
 210mm / 8¼"



TAYLOR MOD.USA
AQ 190.20
 200mm / 8"



BERLINER
AQ 194.20
 200mm / 8"



ALY
AQ 205.17
170mm / 6³/₄"



WARTENBERG
AQ 210.19
190mm / 7¹/₂"



WEBER
AQ 215.09
90mm / 3¹/₂"

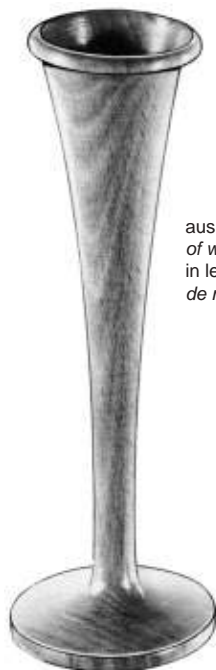

aus Holz,
of wood,
in legno,
de madera

PINARD
AQ 242.18
180mm / 7"



aus Aluminium,
of aluminium,
in alluminio,
de aluminio

PINARD
AQ 248.15
150mm / 6"



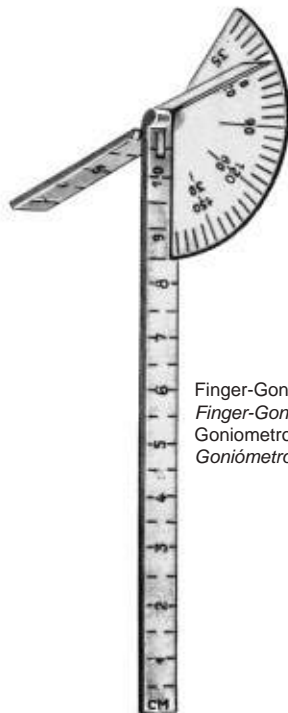

Finger-Goniometer,
Finger-Goniometer,
 Goniometro,
 Goniómetro

CAROLL
AQ 408.01
 140mm / 5½"



Schieblehre,
Caliper,
 Calibro,
 Calibrador

TOWNLEY
AQ 409.01
 100mm / 4¼"

AQ 410.01
 für Kinder,
for children,
 per bambini,
 para niños

AQ 410.02
 für Erwachsene,
for adults,
 per adulti,
 para adultos



COLLIN
AQ 410.01 - AQ 410.02



Schädel-Messzirkel,
Cephalometer (Caliper),
 Cefalometro,
 Cefalómetro

BERTILLON
AQ 412.01



Winkelmesser für die Gliedmassen,
Goniometer (Flexometer),
 Goniometro per le membra,
 Goniómetro para miembros

MOELTGEN
AQ 414.01

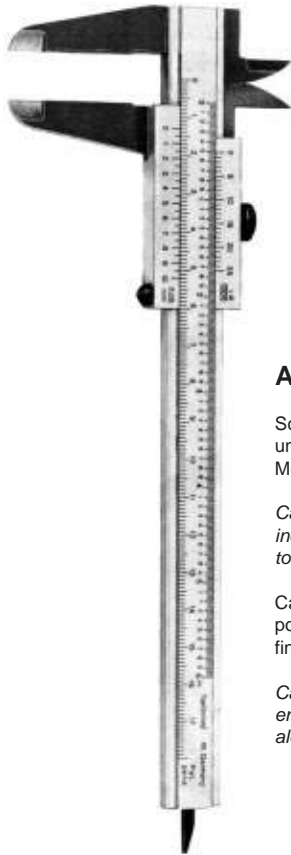

AQ 415.21

Schieblehre aus Aluminium, Millimeter- und Zolleinteilung, Messeinteilung 180mm, Messbereich 139mm.

Caliper of aluminium, graduated in mm and inches up to 180mm, measuring range up to 139mm.

Calibratore in alluminio, graduato in mm e pollici fino a 180mm, capacità di misura fino 139mm.

Calibrador corredizo de aluminio, graduado en mm y pulgadas, graduación hasta 180mm, alcance hasta 139mm.

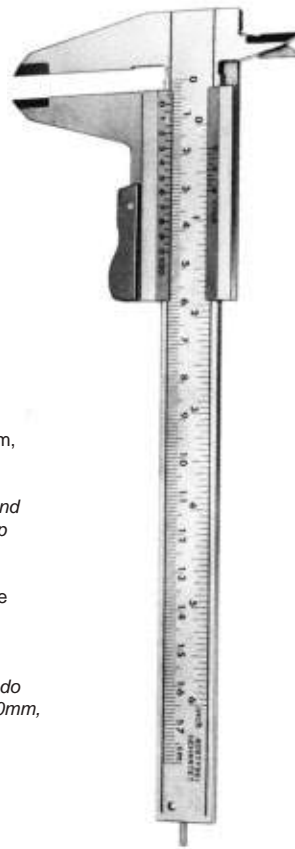

AQ 416.01

Schieblehre aus Stahl, mit Millimeter- und Zolleinteilung, Messbereich bis 120mm mit Nonius in $\frac{1}{10}$ mm und in $\frac{1}{16}$ mm.

Universal Caliper of steel, graduated in millimeters and inches, measuring up to 120mm, with vernier in $\frac{1}{10}$ mm and $\frac{1}{16}$ mm.

Calibratore in acciaio, graduato in mm e pollici, per misure fino a 120mm con nonio in $\frac{1}{10}$ mm e $\frac{1}{16}$ mm.

Calibrador corredizo de acero, graduado en mm y pulgadas, para medidas hasta 120mm, con nonio en $\frac{1}{10}$ mm y $\frac{1}{16}$ mm.

AQ 416.02

dito, aus Kunststoff,
 ditto, of plastic,
 idem, in plastica,
 idem, de plástico

VERNIER
AQ 416.01 - AQ 416.02
 120mm / 4 7/8"



AQ 418.15 // 150mm / 6"

AQ 418.20 // 200mm / 8"

AQ 418.30 // 300mm / 12"

AQ 418.50 // 500mm / 20"



AQ 419.50
 500mm / 20"

Röntgenfähig, X-ray,
 Raggi-X, Rayos-X



AQ 422.15
 150mm / 6"



AQ 425.15
 aus Stahl, in steel,
 in acciaio, en acero

AQ 427.15
 aus Wachstuch, of oilcloth,
 in tela cerata, en tela encerada

Blutdruckmessapparate
Blood Pressure Manometers
Sfigmomanometri
Manómetro de mercurio para la presión de la sangre



AQ 960.00 - AQ 966.00



AQ 970.00 - AQ 976.00



AQ 980.00

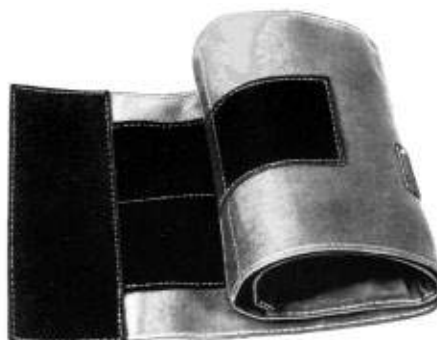

AQ 982.00



AQ 984.00

AQ 960.00 Quecksilber-Blutdruckmessapparat in Etui
 Quecksilberröhre 300mm, geeicht, mit
 Hakenmanschette

AQ 962.00 dito, geeicht, mit Klettmanschette

AQ 964.00 dito, ungeeicht, mit Hakenmanschette

AQ 966.00 dito, ungeeicht, mit Klettmanschette

AQ 970.00 Manometer-Blutdruckmessgerät in Tasche
 geeicht, mit Hakenmanschette

AQ 972.00 dito, geeicht, mit Klettmanschette

AQ 974.00 dito, ungeeicht, mit Hakenmanschette

AQ 976.00 dito, ungeeicht, mit Klettmanschette

AQ 980.00 Hakenmanschette

AQ 982.00 Klettmanschette

- Mercury Blood Pressure Manometer, in case,
 with mercury tube 300mm, calibrated, with hook cuff

- ditto, calibrated, with velcro cuff

- ditto, not calibrated, with hook cuff

- ditto, not calibrated, with velcro cuff

- Blood Pressure Manometer, in pouch, calibrated, with
 hook cuff

- ditto, calibrated, with velcro cuff

- ditto, not calibrated, with hook cuff

- ditto, not calibrated, with velcro cuff

- Hook cuff

- Velcro cuff

AQ 960.00 Sfigmomanometro a mercurio, in scatola, con
 tubo di mercurio 300mm, tarato,
 con bracciale a ganci

AQ 962.00 idem, tarato, con bracciale a velcro

AQ 964.00 idem, non tarato, con bracciale a ganci

AQ 966.00 idem, non tarato, con bracciale a velcro

AQ 970.00 Sfigmomanometro in astuccio, tarato,
 con bracciale a velcro

AQ 972.00 idem, tarato, con bracciale a velcro

AQ 974.00 idem, non tarato, con bracciale a ganci

AQ 976.00 idem, non tarato, con bracciale a velcro

AQ 980.00 Bracciale a ganci

AQ 982.00 Bracciale a velcro

- Manómetro de mercurio para la presión de la sangre,
 en estuche, con tubo de mercurio de 300mm,
 calibrado, con brazaletes de ganchos

- idem, calibrar, con brazaletes de velcro

- idem, sin calibrar, con brazaletes de ganchos

- idem, sin calibrar, con brazaletes de velcro

- Manómetro para la presión de la sangre, en bolsillo,
 calibrado, con brazaletes de ganchos

- idem, calibrar, con brazaletes de velcro

- idem, sin calibrar, con brazaletes de ganchos

- idem, sin calibrar, con brazaletes de velcro

- Brazaletes de ganchos

- Brazaletes de velcro





NARKOSE
ANAESTHESIA
ANESTESIA
ANESTESIA

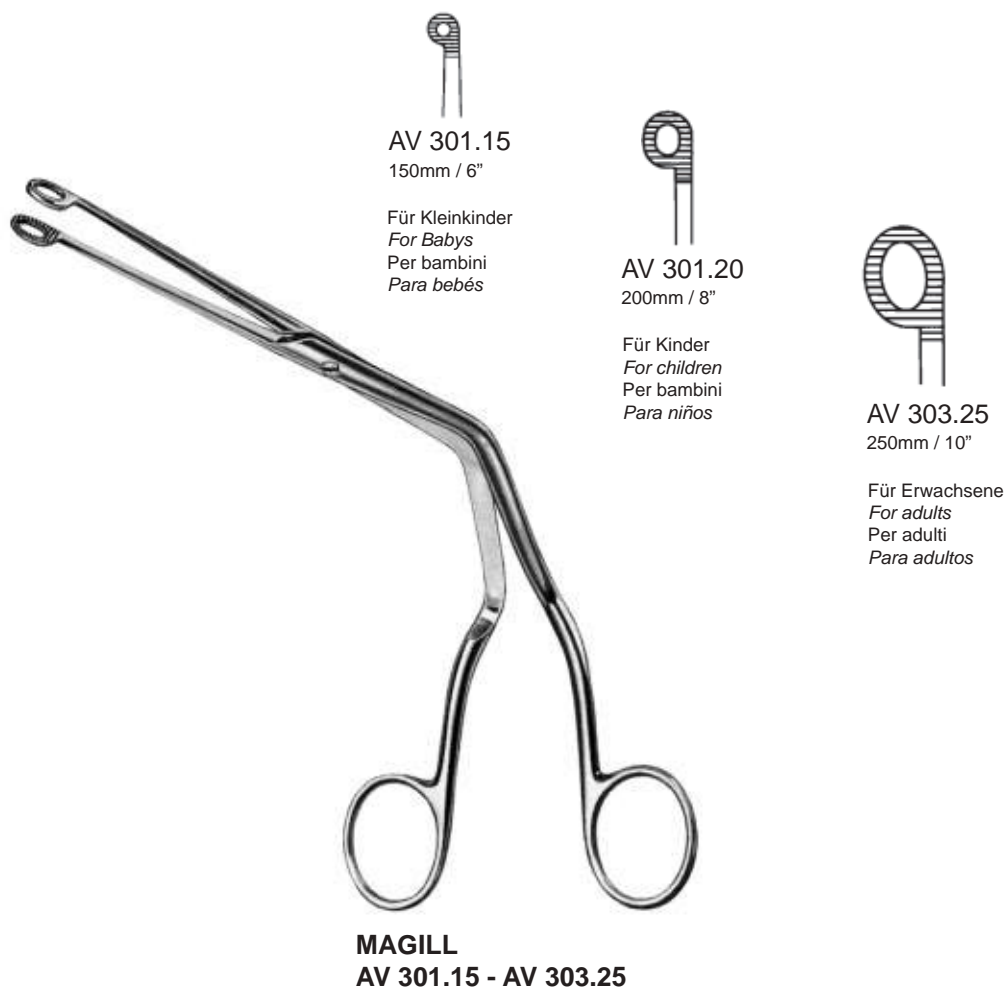



MILLER
AV 350.00 - AV 352.00

AV 350.00 Laryngoskopie Besteck bestehend aus:
AV 392.00 Batteriegriff (ohne Batterie)
AV 353.01 Spatel, Fig.1
AV 353.02 dito, Fig.2
AV 353.03 dito, Fig.3

AV 350.00 Set per laringoscopia, composto da:
AV 392.00 Manico per batteria (senza batteria)
AV 353.01 Spatola, Fig.1
AV 353.02 idem, Fig.2
AV 353.03 idem, Fig.3

AV 351.00
wie AV 350.00 jedoch mit 4 Spatel

AV 351.00
come AV 350.00 però con 4 spatole

AV 352.00 Miller - Baby
Laryngoskopie Besteck für Säuglinge und Kinder
bestehend aus:
AV 392.00 Batteriegriff (ohne Batterie)
AV 353.00 Spatel, Fig.0
AV 353.01 dito, Fig.1

AV 352.00 Miller - Baby
Set per laringoscopia per neonati e bambini
composto da:
AV 392.00 Manico per batteria (senza batteria)
AV 353.00 Spatola, Fig.0
AV 353.01 idem, Fig.1

Miller Laryngoskopie - Spatel
AV 353.00 Fig.0, Nutzlänge 55mm, für Säuglinge
AV 353.01 Fig.1, Nutzlänge 80mm, für Kinder
AV 353.02 Fig.2, Nutzlänge 130mm, für Jugendliche
AV 353.03 Fig.3, Nutzlänge 170mm, für Frauen
AV 353.04 Fig.4, Nutzlänge 180mm, für Männer

Miller Spatole per laringoscopia
AV 353.00 Fig.0, lungh.operativa 55mm, per neonati
AV 353.01 Fig.1, lungh.operativa 80mm, per bambini
AV 353.02 Fig.2, lungh.operativa 130mm, per adolescenti
AV 353.03 Fig.3, lungh.operativa 170mm, per donne
AV 353.04 Fig.4, lungh.operativa 180mm, per uomini



AV 350.00 Laryngoscope Set consisting of:
AV 392.00 Batterie Handle (without battery)
AV 353.01 Blade, Fig.1
AV 353.02 dito, Fig.2
AV 353.03 dito, Fig.3

AV 350.00 Juego para laringoscopia, compuesto de:
AV 392.00 Mango de pila (sin pila)
AV 353.01 Hoja, Fig.1
AV 353.02 idem, Fig.2
AV 353.03 idem, Fig.3

AV 351.00
as AV 350.00 with 4 blades

AV 351.00
como AV 350.00 con 4 hojas

AV 352.00 Miller - Baby
Laryngoscope Set for Baby and Infant,
consisting of:
AV 392.00 Batterie Handle (without batterie)
AV 353.00 Blade, Fig.0
AV 353.01 dito, Fig.1

AV 352.00 Miller - Baby
Juego para laringoscopia para bebés y niños
compuesto de:
AV 392.00 mango de pila (sin pila)
AV 353.00 Hoja, Fig.0
AV 353.01 idem, Fig.1

Miller Laryngoscope Blades
AV 353.00 Fig.0, working length 55mm, for baby's
AV 353.01 Fig.1, working length 80mm, for children's
AV 353.02 Fig.2, working length 130mm, for adolescent's
AV 353.03 Fig.3, working length 170mm, for women's
AV 353.04 Fig.4, working length 180mm, for men's

Miller Hojas para laringoscopia
AV 353.00 Fig.0, largo útil 55mm, para bebés
AV 353.01 Fig.1, largo útil 80mm, para niños
AV 353.02 Fig.2, largo útil 130mm, para adolescentes
AV 353.03 Fig.3, largo útil 170mm, para mujeres
AV 353.04 Fig.4, largo útil 180mm, para hombres



**GUEDEL - NEGUS
AV 360.00 - AV 361.00**



AV 360.00 Laryngoskopie Besteck bestehend aus:
AV 392.00 Batteriegriff (ohne Batterie)
AV 363.02 Spatel, Fig.2
AV 363.03 dito, Fig.3
AV 363.04 dito, Fig.4
AV 398.01 Etui für 3 gerade Spatel

AV 360.00 Set per laringoscopia, composto da:
AV 392.00 Manico per batteria (senza batteria)
AV 363.02 Spatola, Fig.2
AV 363.03 idem, Fig.3
AV 363.04 idem, Fig.4
AV 398.01 Scatola per 3 spatole rette

AV 361.00 Laryngoskopie Besteck bestehend aus:
AV 392.00 Batteriegriff (ohne Batterie)
AV 363.01 Spatel, Fig.1
AV 363.02 dito, Fig.2
AV 363.03 dito, Fig.3
AV 363.04 dito, Fig.4
AV 398.02 Etui für 4 gerade Spatel

AV 361.00 Set per laringoscopia, composto da:
AV 392.00 Manico per batteria (senza batteria)
AV 363.01 Spatola, Fig.1
AV 363.02 idem, Fig.2
AV 363.03 idem, Fig.3
AV 363.04 idem, Fig.4
AV 398.02 Scatola per 4 spatole rette

Guedel Laryngoskopie - Spatel

AV 363.01 Fig.1, Nutzlänge 70mm, für Kinder
AV 363.02 Fig.2, Nutzlänge 90mm, für Jugendliche
AV 363.03 Fig.3, Nutzlänge 110mm, für Frauen
AV 363.04 Fig.4, Nutzlänge 135mm, für Männer

Guedel Spatole per laringoscopia

AV 363.01 Fig.1, lungh.operativa 70mm, per bambini
AV 363.02 Fig.2, lungh.operativa 90mm, per adolescenti
AV 363.03 Fig.3, lungh.operativa 110mm, per donne
AV 363.04 Fig.4, lungh.operativa 135mm, per uomini

AV 360.00 Laryngoscope Set consisting of:
AV 392.00 Batterie Handle (without battery)
AV 363.02 Blade, Fig.2
AV 363.03 ditto, Fig.3
AV 363.04 ditto, Fig.4
AV 398.01 Case for 3 straight blades

AV 360.00 Juego para laringoscopia, compuesto de:
AV 392.00 Mango de pila (sin pila)
AV 363.02 Hoja, Fig.2
AV 363.03 idem, Fig.3
AV 363.04 idem, Fig.4
AV 398.01 Estuche para 3 hojas rectas

AV 361.00 Laryngoscope Set consisting of:
AV 392.00 Batterie Handle (without battery)
AV 363.01 Blade, Fig.1
AV 363.02 ditto, Fig.2
AV 363.03 ditto, Fig.3
AV 363.04 ditto, Fig.4
AV 398.02 Case for 4 straight blades

AV 360.00 Juego para laringoscopia, compuesto de:
AV 392.00 Mango de pila (sin pila)
AV 363.01 Hoja, Fig.1
AV 363.02 idem, Fig.2
AV 363.03 idem, Fig.3
AV 363.04 idem, Fig.4
AV 398.02 Estuche para 4 hojas rectas

Guedel Laryngoscope Blades

AV 363.01 Fig.1, working length 70mm, for children's
AV 363.02 Fig.2, working length 90mm, for adolescent's
AV 363.03 Fig.3, working length 110mm, for women's
AV 363.04 Fig.4, working length 135mm, for men's

Guedel Hojas para laringoscopia

AV 363.01 Fig.1, largo útil 70mm, para niños
AV 363.02 Fig.2, largo útil 90mm, para adolescentes
AV 363.03 Fig.3, largo útil 110mm, para mujeres
AV 363.04 Fig.4, largo útil 135mm, para hombres



MC INTOSH
AV 380.00 - AV 384.00



AV 383.00



AV 383.01



AV 383.02



AV 383.03



AV 383.04

AV 380.00 Laryngoskopie Besteck bestehend aus:
AV 392.00 Batteriegriff (ohne Batterie)
AV 383.01 Spatel, Fig.1
AV 383.02 dito, Fig.2
AV 383.03 dito, Fig.3
AV 398.03 Etui für 3 gebogene Spatel

AV 380.00 Set per laringoscopia, composto da:
AV 392.00 Manico per batteria (senza batteria)
AV 383.01 Spatola, Fig.1
AV 383.02 idem, Fig.2
AV 383.03 idem, Fig.3
AV 398.03 Scatola per 3 spatole curve

AV 384.00 Laryngoskopie Besteck bestehend aus:
AV 392.00 Batteriegriff (ohne Batterie)
AV 383.01 Spatel, Fig.1
AV 383.02 dito, Fig.2
AV 383.03 dito, Fig.3
AV 383.04 dito, Fig.4
AV 398.04 Etui für 4 gebogene Spatel

AV 384.00 Set per laringoscopia, composto da:
AV 392.00 Manico per batteria (senza batteria)
AV 383.01 Spatola, Fig.1
AV 383.02 idem, Fig.2
AV 383.03 idem, Fig.3
AV 383.04 idem, Fig.4
AV 398.04 Scatola per 4 spatole curve

Mc Intosh Laryngoskopie - Spatel

AV 383.00 Fig.0, Nutzlänge 55mm, für Säuglinge
AV 383.01 Fig.1, Nutzlänge 75mm, für Kinder
AV 383.02 Fig.2, Nutzlänge 90mm, für Jugendliche
AV 383.03 Fig.3, Nutzlänge 110mm, für Frauen
AV 383.04 Fig.4, Nutzlänge 135mm, für Männer

Mc Intosh Spatole per laringoscopia

AV 383.00 Fig.0, lungh.operativa 55mm, per neonati
AV 383.01 Fig.1, lungh.operativa 75mm, per bambini
AV 383.02 Fig.2, lungh.operativa 90mm, per adolescenti
AV 383.03 Fig.3, lungh.operativa 110mm, per donne
AV 383.04 Fig.4, lungh.operativa 135mm, per uomini

AV 380.00 Laryngoscope Set consisting of:
AV 392.00 Batterie Handle (without battery)
AV 383.01 Blade, Fig.1
AV 383.02 ditto, Fig.2
AV 383.03 ditto, Fig.3
AV 398.03 Case for 3 curved blades

AV 380.00 Juego para laringoscopia, compuesto de:
AV 392.00 Mango de pila (sin pila)
AV 383.01 Hoja, Fig.1
AV 383.02 idem, Fig.2
AV 383.03 idem, Fig.3
AV 398.03 Estuche para 3 hojas curvas

AV 384.00 Laryngoscope Set consisting of:
AV 392.00 Batterie Handle (without battery)
AV 383.01 Blade, Fig.1
AV 383.02 ditto, Fig.2
AV 383.03 ditto, Fig.3
AV 383.04 ditto, Fig.4
AV 398.04 Case for 4 curved blades

AV 384.00 Juego para laringoscopia, compuesto de:
AV 392.00 Mango de pila (sin pila)
AV 383.01 Hoja, Fig.1
AV 383.02 idem, Fig.2
AV 383.03 idem, Fig.3
AV 383.04 idem, Fig.4
AV 398.04 Estuche para 4 hojas curvas

Mc Intosh Laryngoscope Blades

AV 383.00 Fig.0, working length 55mm, for baby's
AV 383.01 Fig.1, working length 75mm, for children's
AV 383.02 Fig.2, working length 90mm, for adolescent's
AV 383.03 Fig.3, working length 110mm, for women's
AV 383.04 Fig.4, working length 135mm, for men's

Mc Intosh Hojas para laringoscopia

AV 383.00 Fig.0, largo útil 55mm, para bebés
AV 383.01 Fig.1, largo útil 75mm, para niños
AV 383.02 Fig.2, largo útil 90mm, para adolescentes
AV 383.03 Fig.3, largo útil 110mm, para mujeres
AV 383.04 Fig.4, largo útil 135mm, para hombres



FOREGGER
AV 390.00 - AV 391.00



AV 390.00 Laryngoskopie Besteck bestehend aus:
AV 392.00 Batteriegriff (ohne Batterie)
AV 387.02 Spatel, Fig.2
AV 387.03 dito, Fig.3
AV 387.04 dito, Fig.4
AV 398.01 Etui für 3 gerade Spatel

AV 390.00 Set per laringoscopia, composto da:
AV 392.00 Manico per batteria (senza batteria)
AV 387.02 Spatola, Fig.2
AV 387.03 idem, Fig.3
AV 387.04 idem, Fig.4
AV 398.01 Scatola per 3 spatole rette

AV 391.00 Laryngoskopie Besteck bestehend aus:
AV 392.00 Batteriegriff (ohne Batterie)
AV 387.01 Spatel, Fig.1
AV 387.02 dito, Fig.2
AV 387.03 dito, Fig.3
AV 387.04 dito, Fig.4
AV 398.02 Etui für 4 gerade Spatel

AV 391.00 Set per laringoscopia, composto da:
AV 392.00 Manico per batteria (senza batteria)
AV 387.01 Spatola, Fig.1
AV 387.02 idem, Fig.2
AV 387.03 idem, Fig.3
AV 387.04 idem, Fig.4
AV 398.02 Scatola per 4 spatole rette

Foregger Laryngoskopie - Spatel

AV 387.01 Fig.1, Nutzlänge 70mm, für Kinder
AV 387.02 Fig.2, Nutzlänge 90mm, für Jugendliche
AV 387.03 Fig.3, Nutzlänge 110mm, für Frauen
AV 387.04 Fig.4, Nutzlänge 135mm, für Männer

Foregger Spatole per laringoscopia

AV 387.01 Fig.1, lungh.operativa 70mm, per bambini
AV 387.02 Fig.2, lungh.operativa 90mm, per adolescenti
AV 387.03 Fig.3, lungh.operativa 110mm, per donne
AV 387.04 Fig.4, lungh.operativa 135mm, per uomini

AV 390.00 Laryngoscope Set consisting of:
AV 392.00 Batterie Handle (without battery)
AV 387.02 Blade, Fig.2
AV 387.03 ditto, Fig.3
AV 387.04 ditto, Fig.4
AV 398.01 Case for 3 straight blades

AV 390.00 Juego para laringoscopia, compuesto de:
AV 392.00 Mango de pila (sin pila)
AV 387.02 Hoja, Fig.2
AV 387.03 idem, Fig.3
AV 387.04 idem, Fig.4
AV 398.01 Estuche para 3 hojas rectas

AV 391.00 Laryngoscope Set consisting of:
AV 392.00 Batterie Handle (without battery)
AV 387.01 Blade, Fig.1
AV 387.02 ditto, Fig.2
AV 387.03 ditto, Fig.3
AV 387.04 ditto, Fig.4
AV 398.02 Case for 4 straight blades

AV 391.00 Juego para laringoscopia, compuesto de:
AV 392.00 Mango de pila (sin pila)
AV 387.01 Hoja, Fig.1
AV 387.02 idem, Fig.2
AV 387.03 idem, Fig.3
AV 387.04 idem, Fig.4
AV 398.02 Estuche para 4 hojas rectas

Foregger Laryngoscope Blades

AV 387.01 Fig.1, working length 70mm, for children's
AV 387.02 Fig.2, working length 90mm, for adolescent's
AV 387.03 Fig.3, working length 110mm, for women's
AV 387.04 Fig.4, working length 135mm, for men's

Foregger Hojas para laringoscopia

AV 387.01 Fig.1, largo útil 70mm, para niños
AV 387.02 Fig.2, largo útil 90mm, para adolescentes
AV 387.03 Fig.3, largo útil 110mm, para mujeres
AV 387.04 Fig.4, largo útil 135mm, para hombres



AV 392.00

Batteriegriff,
Battery Handle,
Mancio per batteria,
Mango de pila



AV 393.00

Akku-Einsatz für Batteriegriff,
Rechargeable accumulator insert for battery handle
Accumulatore ricaricabile da usare con manico per batteria,
Acumulador recargable para usar con mango de pila



AV 395.00

Ersatzbirne groß für Laryngoskopie-Spatel Fig.2-4,
Spare bulb, large size, for laryngoscope blades Fig.2-4,
Lampadina di ricambio, grande, per spatole per laringoscopia Fig.2-4,
Bombilla de repuesto, grande, para hojas de laringoscopios Fig.2-4



AV 395.01

Ersatzbirne klein für Laryngoskopie-Spatel Fig.0-1,
Spare bulb, small size, for laryngoscope blades Fig.0-1,
Lampadina di ricambio, piccola, per spatole per laringoscopia Fig.0-1,
Bombilla de repuesto, pequeña, para hojas de laringoscopios Fig.0-1





TROKARE, SAUGROHRE
TROCARS, SUCTION TUBES
TREQUARTI, TUBI D'ASPIRAZIONE
TRÓCARES, TUBOS DE ASPIRACIÓN



AY 304.03
Satz zu 3 Stück,
Set of 3 pieces,
Serie di 3 pezzi,
Juego de 3 piezas

AY 306.04
Satz zu 4 Stück,
Set of 4 pieces,
Serie di 4 pezzi,
Juego de 4 piezas

UNIVERSAL
AY 304.03 - AY 306.04



STANDARD
AY 310.11 - AY 316.11
110mm / 4½"

- AY 310.11 // Ø 3mm
- AY 312.11 // Ø 4mm
- AY 314.11 // Ø 5mm
- AY 316.11 // Ø 6mm



STANDARD
AY 320.11 - AY 326.11
120mm / 4¾"

- AY 320.11 // Ø 3mm
- AY 322.11 // Ø 4mm
- AY 324.11 // Ø 5mm
- AY 326.11 // Ø 6mm

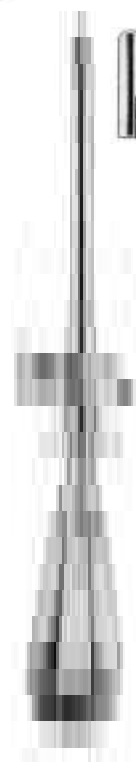

STANDARD
AY 330.11 - AY 336.11
120mm / 4¾"

- AY 330.11 // Ø 3mm
- AY 332.11 // Ø 4mm
- AY 334.11 // Ø 5mm
- AY 336.11 // Ø 6mm



NELSON
AY 348.07 - AY 352.11
210mm / 8¼"



OCHSNER
AY 402.14 - AY 406.14
140mm / 5½"

- AY 402.14 // Ø 4mm
- AY 404.14 // Ø 5,5mm
- AY 406.14 // Ø 6,5mm



LICHTWITZ
AY 490.19
 190mm / 7½"



PIERCE
AY 495.15
 150mm / 6"



KRAUSE
AY 505.15
 150mm / 6"



DOUGLAS
AY 519.11
 110mm / 4½"

Ø 4mm



ADSON
AY 521.21
 210mm / 8¼"

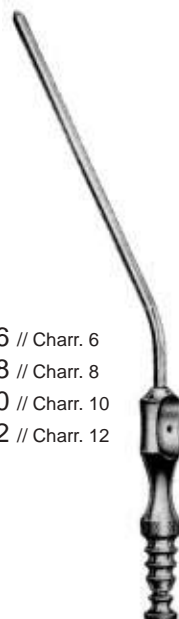

FRAZIER
AY 523.06 - AY 523.12
 190mm / 7½"

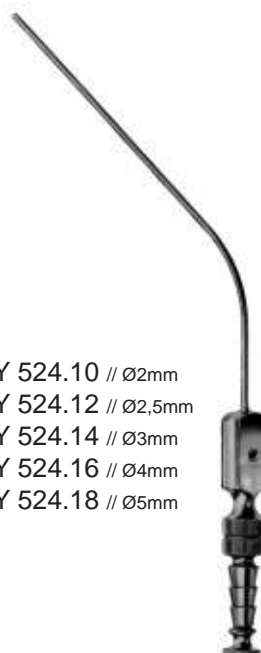

FERGUSSON
AY 524.10 - AY 524.18
 180mm / 7"

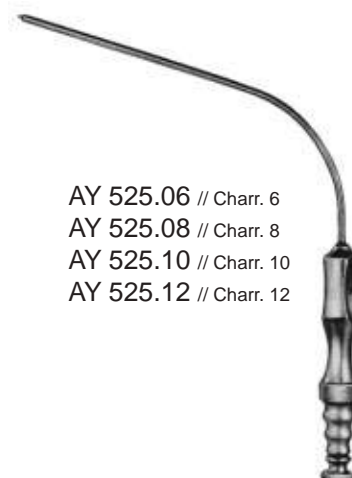

POPPE
AY 525.06 - AY 525.12
 130mm / 5"

AY 523.06 // Charr. 6
 AY 523.08 // Charr. 8
 AY 523.10 // Charr. 10
 AY 523.12 // Charr. 12

AY 524.10 // Ø2mm
 AY 524.12 // Ø2,5mm
 AY 524.14 // Ø3mm
 AY 524.16 // Ø4mm
 AY 524.18 // Ø5mm

AY 525.06 // Charr. 6
 AY 525.08 // Charr. 8
 AY 525.10 // Charr. 10
 AY 525.12 // Charr. 12

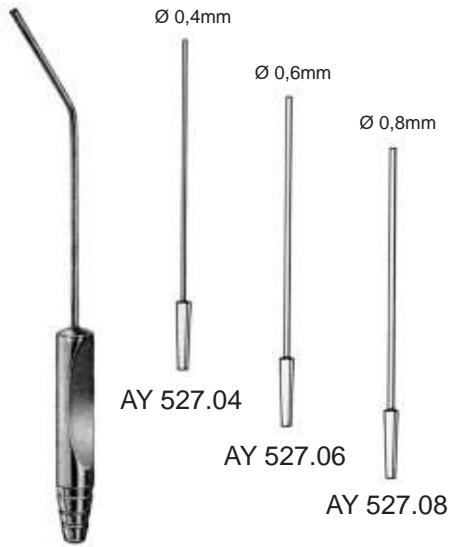

WULLSTEIN
AY 527.00
 140mm / 5½"
 Satz, Serie, Set, Juego

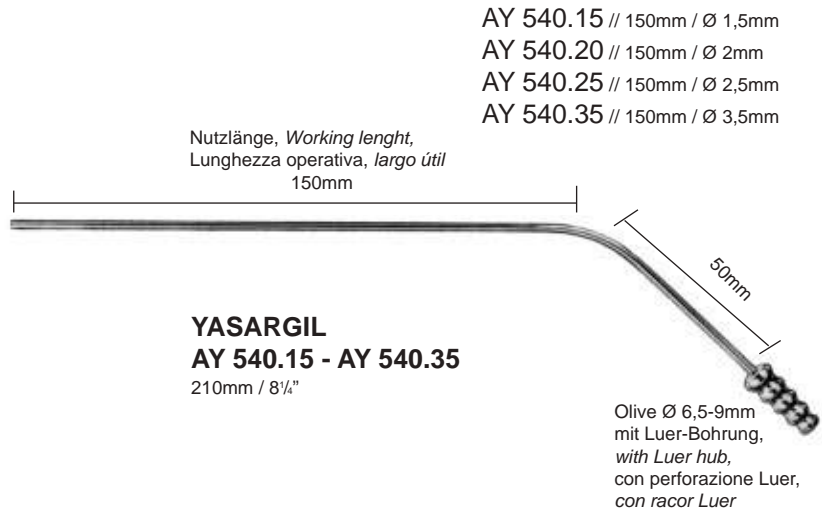

YASARGIL
AY 540.15 - AY 540.35
 210mm / 8¼"

Olive Ø 6,5-9mm
 mit Luer-Bohrung,
 with Luer hub,
 con perforazione Luer,
 con racor Luer



YANKAUER
AY 543.27
 270mm / 10½"

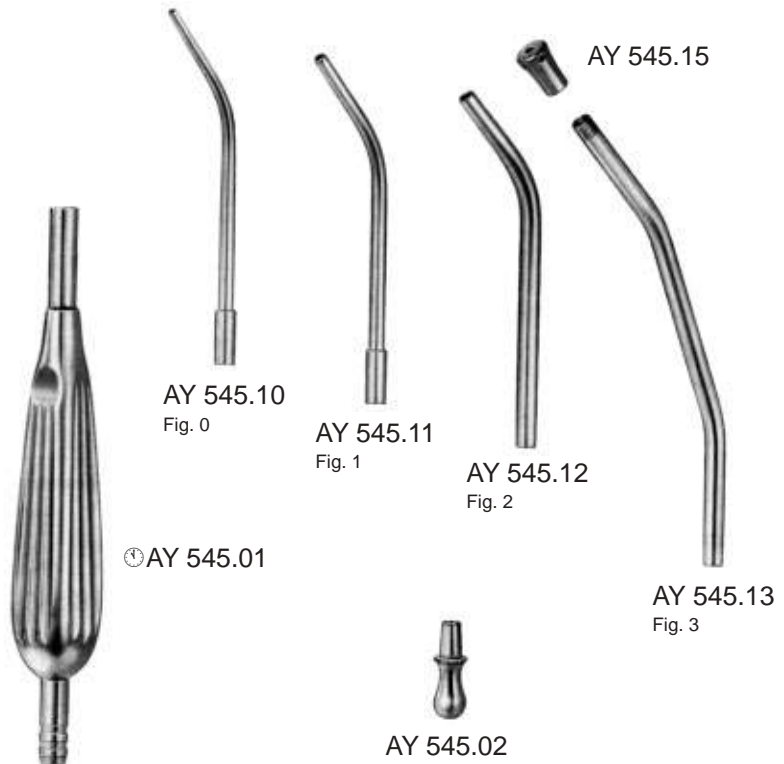

YANKAUER
AY 545.00 - AY 545.15
 270mm / 10½"
 Fig. 0-3

Ø 10mm



**POOLE
 AY 550.22**
 220mm / 8½"

Ø 8mm



**POOLE
 AY 551.22**
 220mm / 8½"

Ø 8mm



**COOLEY
 AY 561.35**
 350mm / 13¾"

Ø 10mm



**COOLEY
 AY 563.31**
 310mm / 12½"

Ø 7mm



**COOLEY
 AY 565.30**
 300mm / 12"

Ø 8mm



**COOLEY
 AY 567.33**
 330mm / 13"



6mm
 rund,
round,
 rotondo,
 redondo



NUBOER
AY 569.21
 210mm / 8¼"



6mm
 oval,
oval,
 ovale,
 oval



NUBOER
AY 571.21
 210mm / 8¼"



COUPLAND
AY 575.24
 170mm / 6¾"



○ AY 575.01 // Ø 1,5mm

○ AY 575.02 // Ø 2mm

○ AY 575.03 // Ø 2,5mm

○ AY 575.04 // Ø 3,5mm



○ AY 575.05 // Ø 1,5mm

○ AY 575.06 // Ø 2mm

○ AY 575.07 // Ø 2,5mm

○ AY 575.08 // Ø 3,5mm

mit zusätzlichen Seitenlöcher,
with additional side holes,
 con fori laterale addizionale,
 con agujeros laterale adicionales



○ AY 577.01 // Ø 1,5mm

○ AY 577.02 // Ø 2,5mm

○ AY 577.03 // Ø 3,5mm

BYRD
AY 577.01 - AY 577.03
 200mm / 8"



REDON
AY 580.08 - AY 580.18

AY 580.08 // Charr. 8
AY 580.10 // Charr. 10
AY 580.12 // Charr. 12
AY 580.14 // Charr. 14
AY 580.16 // Charr. 16
AY 580.18 // Charr. 18



REDON
AY 581.08 - AY 581.18

AY 581.08 // Charr. 8
AY 581.10 // Charr. 10
AY 581.12 // Charr. 12
AY 581.14 // Charr. 14
AY 581.16 // Charr. 16
AY 581.18 // Charr. 18

Lanzettenspitze,
Lancet tip,
Punta a lancetta,
Punta lanceolar



REDON
AY 583.08 - AY 583.18

AY 583.08 // Charr. 8
AY 583.10 // Charr. 10
AY 583.12 // Charr. 12
AY 583.14 // Charr. 14
AY 583.16 // Charr. 16
AY 583.18 // Charr. 18





**CARDIOVASCULAR
CARDIOVASCULAR SURGERY
CHIRURGIA CARDIOVASCOLARE
CIRUGÍA CARDIOVASCULAR**



CA 100.23
230mm / 9"



COLLIN
CA 101.22
220mm / 8 3/4"



CA 104.17
170mm / 6 3/4"

mit ziehendem Schnitt,
with eccentric sliding blade,
con lama di retroazione,
con hoja de retroacción



GLUCK
CA 107.22
220mm / 8 3/4"



STILLE
CA 111.21
210mm / 8 1/4"



SAUERBRUCH
CA 131.26
260mm / 10 1/4"



GIERTZ - STILLE
CA 137.27
270mm / 10 1/2"



BRUNNER
CA 147.28 - CA 149.28
320mm / 12 1/2"

CA 147.28
für die rechte Hand,
for the right hand,
per la mano destra,
para la mano derecha

CA 149.28
für die linke Hand,
for the left hand,
per la mano sinistra,
para la mano izquierda



LEBSCHER
CM 151.24
240mm / 9 1/2"

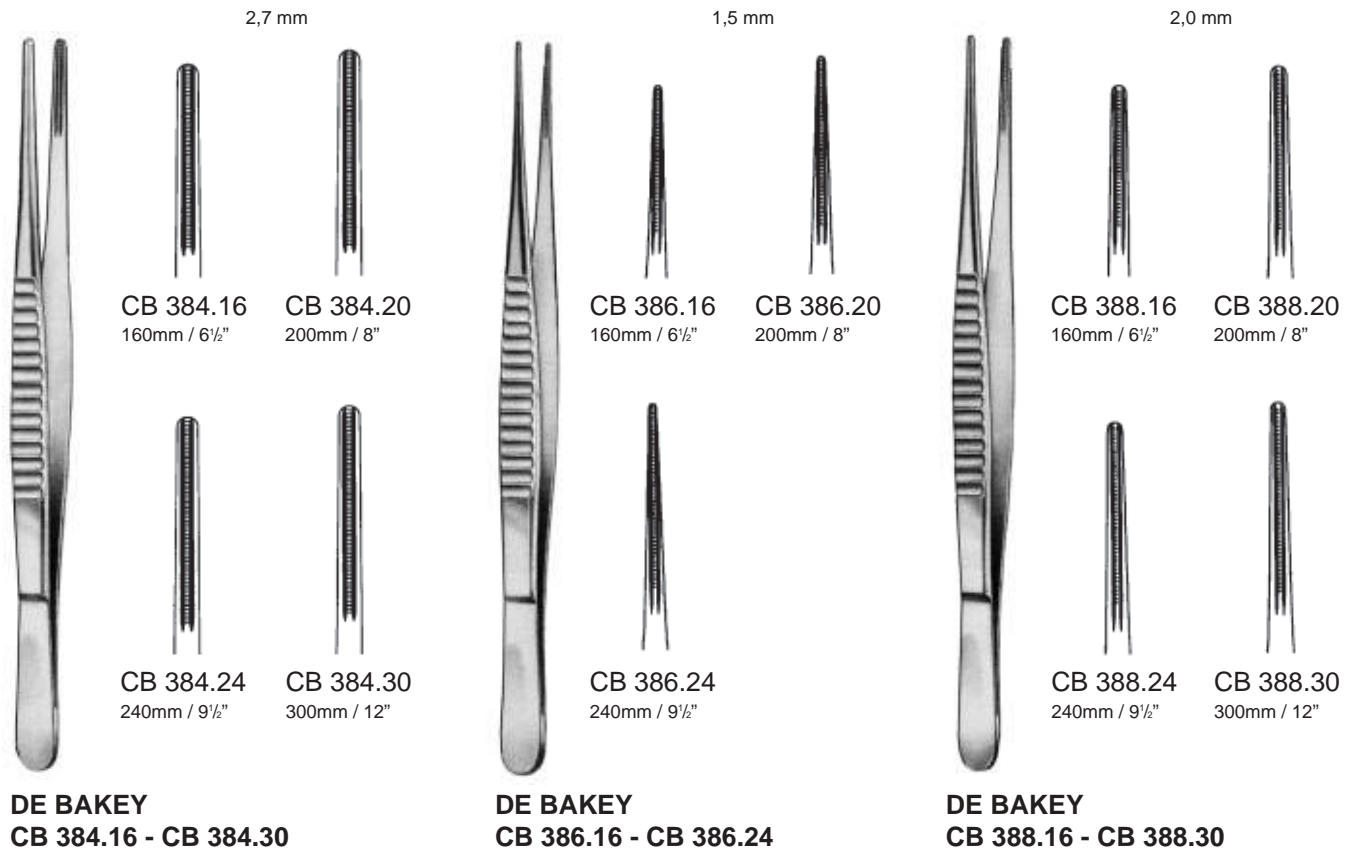

Titan
Titanium
Titanio
Titanio



CC 132.30 - CC 132.50
CC 142.30 - CC 142.50

CC 132.30 V CC 142.30 A 30mm / 1 1/4"	CC 132.35 V CC 142.35 A 35mm / 1 1/2"	CC 132.40 V CC 142.40 A 40mm / 1 3/4"	CC 132.50 V CC 142.50 A 50mm / 2"	Vena Arteria



CC 133.30 - CC 133.50
CC 143.30 - CC 143.50

CC 133.30 V CC 143.30 A 30mm / 1 1/4"	CC 133.35 V CC 143.35 A 35mm / 1 1/2"	CC 133.40 V CC 143.40 A 40mm / 1 3/4"	CC 133.50 V CC 143.50 A 50mm / 2"	Vena Arteria



CC 135.30 - CC 135.50
CC 145.30 - CC 145.50

CC 135.30 V CC 145.30 A 30mm / 1 1/4"	CC 135.35 V CC 145.35 A 35mm / 1 1/2"	CC 135.40 V CC 145.40 A 40mm / 1 3/4"	CC 135.50 V CC 145.50 A 50mm / 2"	Vena Arteria

Bronchusklemmen
Bronchus Forceps
Pinze per bronchi
Pinzas clamps bronquiales



PRICE - THOMAS
CC 241.22
 220mm / 8³/₄"



PRICE - THOMAS
CC 245.22 - CC 247.22
 220mm / 8³/₄"

CC 245.22

CC 247.22



CC 265.24

CC 267.24

SEMB
CC 265.24 - CC 267.24
 240mm / 9¹/₂"



DE BAKEY - SATINSKY
CC 291.07
70mm / 2 $\frac{3}{4}$ "



DE BAKEY - CAROTIS
CC 291.09
90mm / 3 $\frac{1}{2}$ "

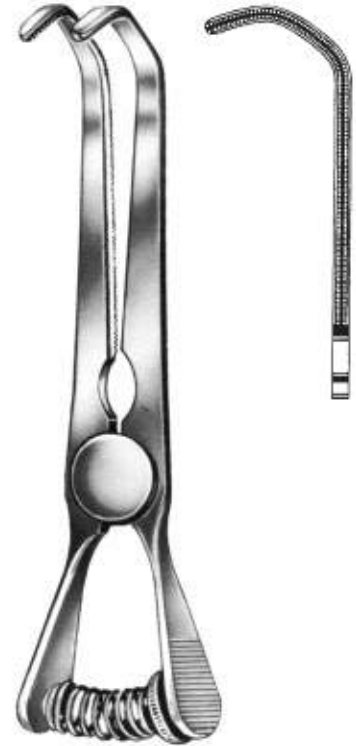

DE BAKEY - SATINSKY
CC 291.10
100mm / 4 $\frac{1}{4}$ "



GLOVER
CC 293.06
60mm / 2 $\frac{1}{4}$ "



SANTULLI
CC 295.07
70mm / 2 $\frac{3}{4}$ "



GREGORY - SOFT
CC 297.09 - CC 297.11



CC 297.09
90mm / 3½"



CC 297.11
110mm / 4½"



GREGORY - SOFT
CC 299.01 - CC 299.02
110mm / 4½"



CC 299.01
links, *left*,
sinistra, *izquierda*



CC 299.02
rechts, *right*,
destra, *derecha*

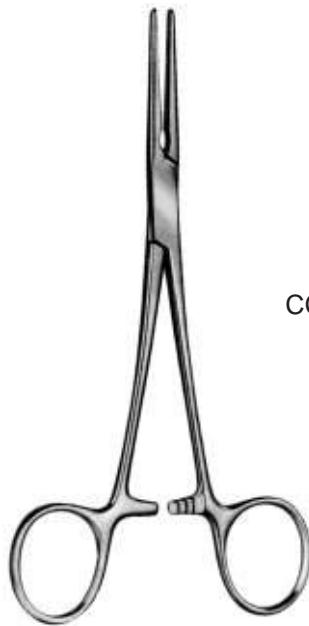

CC 300.16



CC 301.16

DE BAKEY - RANKIN
 CC 300.16 - CC 301.16

160mm / 6½"



CC 302.15



CC 303.15

DE BAKEY - MOSQUITO
 CC 302.15 - CC 303.15

150mm / 6"



OCHSNER
 CC 317.23

230mm / 9"

Aortaklemmen, Aortic - clamps,
 Pinze per l'aorta, Pinzas para aorta

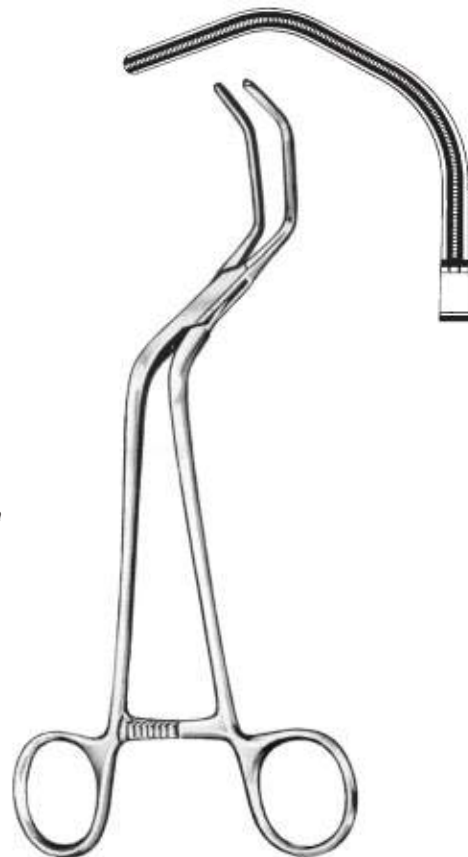

DIETRICH
 CC 319.21

210mm / 8½"

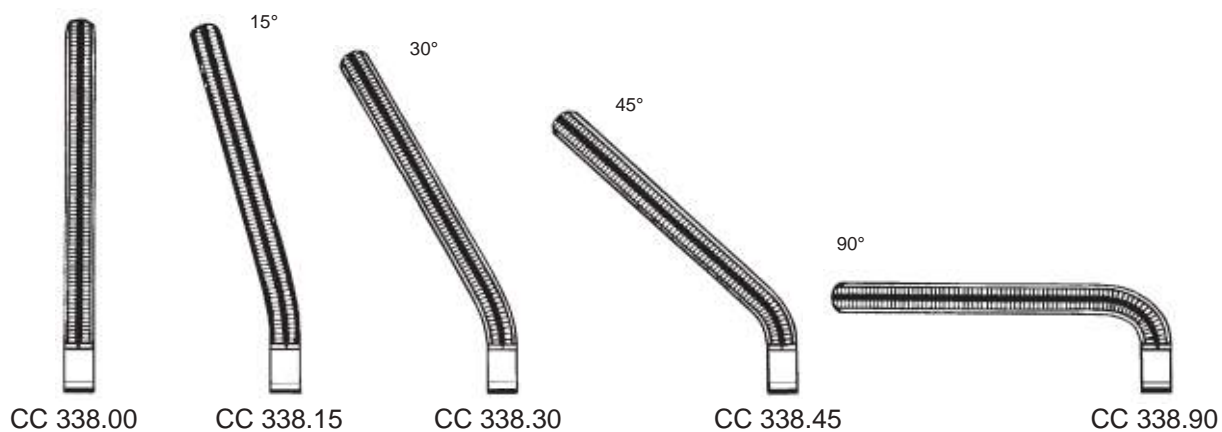
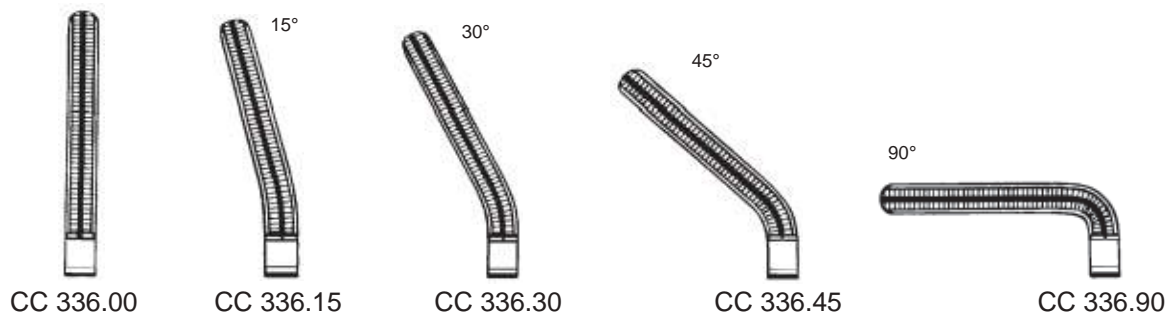

DARDIK
CC 336.00 - CC 336.90 // 150mm / 6"
CC 338.00 - CC 338.90 // 170mm / 6¾"

Peripheral - Gefäßclammen, *Peripheral Vascular - Clamps*,
 Pinze per vasi periferici, *Pinzas para vasos periféricos*



DALE
CC 340.18
 180mm / 7"

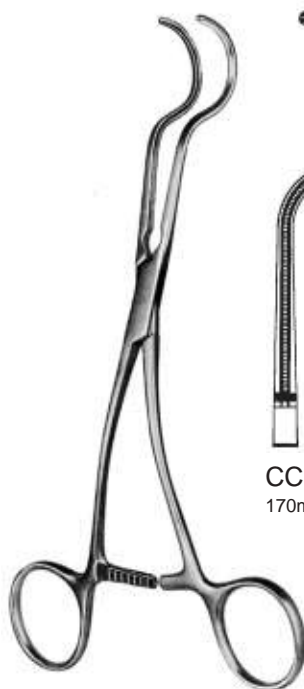

DALE
CC 341.17 - CC 341.19

CC 341.17
 170mm / 6½"



CC 341.18
 180mm / 7"



CC 341.19
 190mm / 7½"



GREGORY
CC 342.14 - CC 342.18



CC 342.14
 140mm / 5½"



CC 342.16
 160mm / 6½"

Profundaklappen, *Profunda clamps*,
 Pinze profunde, *Pinzas profundales*

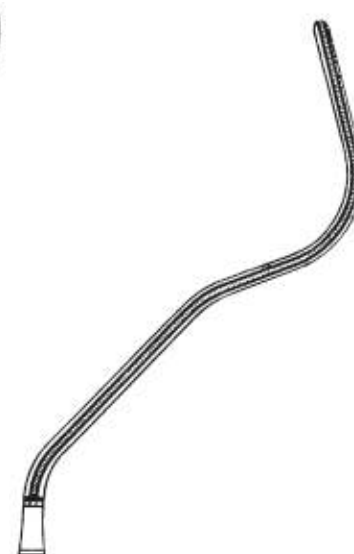

CC 342.18
 180mm / 7"

Karotisklemmen, *Carotid Clamps*,
Pinze per la carotide, *Pinzas para carótida*



CC 343.18
180mm / 7"



CC 343.19
190mm / 7½"

JAVID
CC 343.18 - CC 343.19

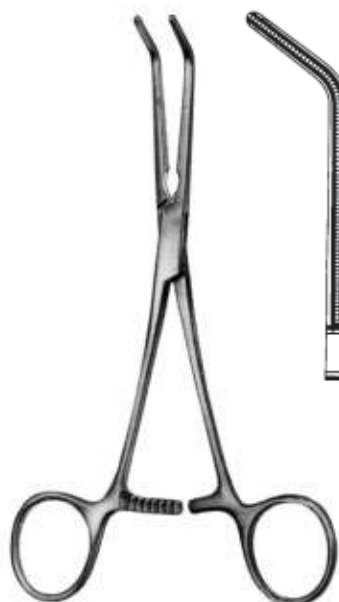

HUSFELDT
CC 345.18
180mm / 7"



HUSFELDT
CC 347.18
180mm / 7"



HUSFELDT
CC 349.17
170mm / 6¾"

Karotisklemmen, *Carotid Clamps*,
Pinze per la carotide, *Pinzas para carótida*

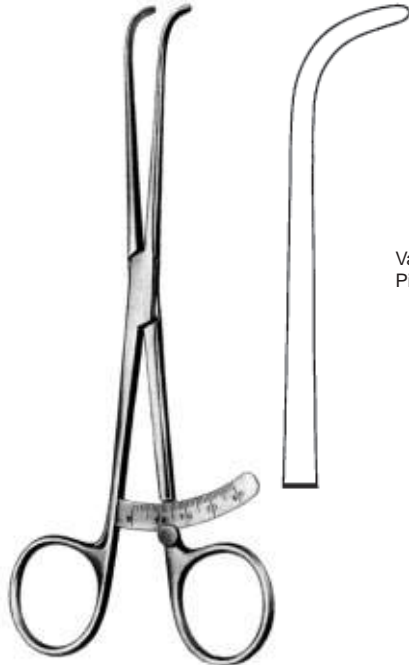

Vascular Zirkel, Vascular measuring Device,
 Pinza vascolare compasso, Compás para medir vasos

CC 349.18
 180mm / 7"

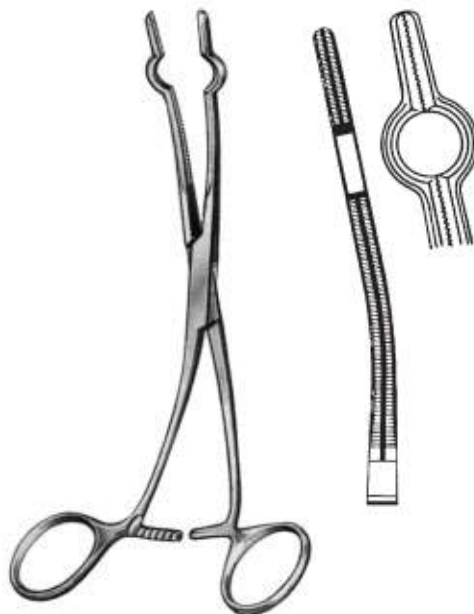

COOLEY
 CC 350.01 - CC 350.07

Für Kinder, *for children,* Charrière (French)
 Per bambini, *para niños*

CC 350.01 // 160mm / 6½" // 24

CC 350.02 // 160mm / 6½" // 26

Für Erwachsene, *for adults,*
 Per adulti, *para adultos*

CC 350.03 // 200mm / 8" // 28

CC 350.04 // 200mm / 8" // 30

CC 350.05 // 200mm / 8" // 32

CC 350.07 // 200mm / 8" // 36



CC 392.07
75mm / 3"



CC 392.08
85mm / 3 1/4"



CC 392.10
100mm / 4 1/4"



CC 392.12
120mm / 4 3/4"



CC 392.07 - CC 392.12

Anlegepinzette,
 Setting Forceps,
 Pinza per applicare clips,
 Pinza para poner clips

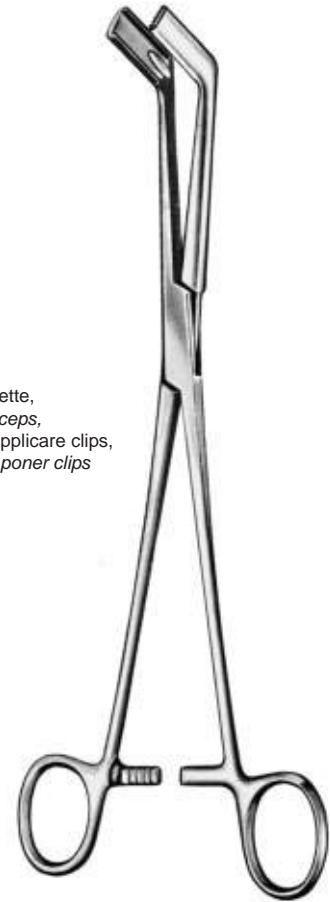

CC 395.23
230mm / 9"



CC 393.07
70mm / 2 3/4"



CC 393.08
80mm / 3 1/4"



CC 393.10
100mm / 4 1/4"



CC 393.12
120mm / 4 3/4"



CC 393.07 - CC 393.12

Atraumatic - Bulldogklemmen
Atraumatic - Bulldog Clamps
Atraumatic - Pinze Bulldog
Atraumatic - Clamps Bulldog



CC 398.06
60mm / 2 1/4"



CC 398.07
70mm / 2 3/4"



CC 398.09
90mm / 3 1/2"



CC 398.11
110mm / 4 1/2"



GLOVER
CC 398.06 - CC 398.11

Anlegepinzette,
Setting Forceps,
Pinza per applicare clips,
Pinza para poner clips

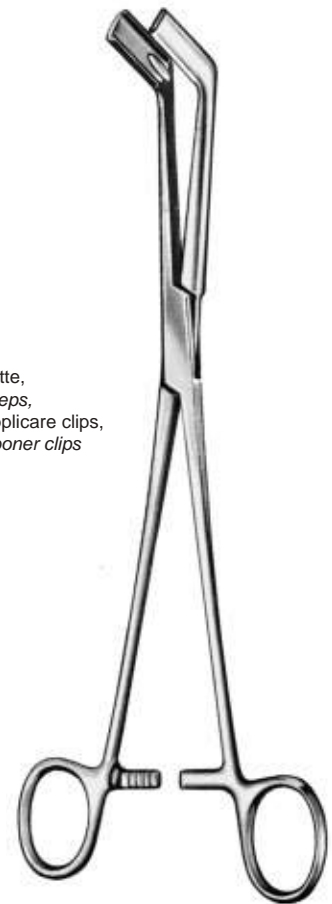

CC 395.23
230mm / 9"



CC 399.06
60mm / 2 1/4"



CC 399.07
70mm / 2 3/4"



CC 399.09
90mm / 3 1/2"



CC 399.11
110mm / 4 1/2"



GLOVER
CC 399.06 - CC 399.11

Atraumatic - Cardiovascularclammen
Atraumatic - Cardiovascular Forceps
Atraumatic - Pinze cardiovascolari
Atraumatic - Pinzas - clamps cardiovasculares



Coarctations - Klemmen, Coarctation - Clamps,
 Pinze per coartazione, Pinzas para coartación

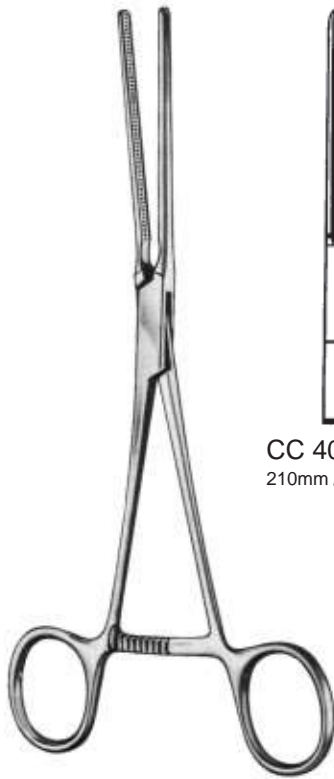

CC 400.21
 210mm / 8³/₄"



CC 400.22
 220mm / 8³/₄"

POTTS (DE BAKEY)
CC 400.21 - CC 400.22



CC 401.21
 210mm / 8³/₄"



CC 401.22
 220mm / 8³/₄"

POTTS
CC 401.21 - CC 401.22

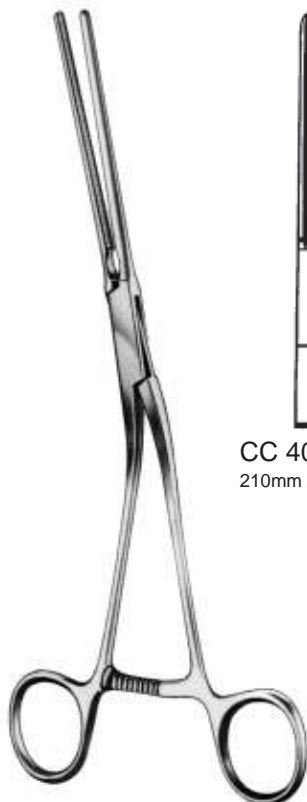

CC 403.21
 210mm / 8³/₄"



CC 403.22
 220mm / 8³/₄"

POTTS (DE BAKEY)
CC 403.21 - CC 403.22

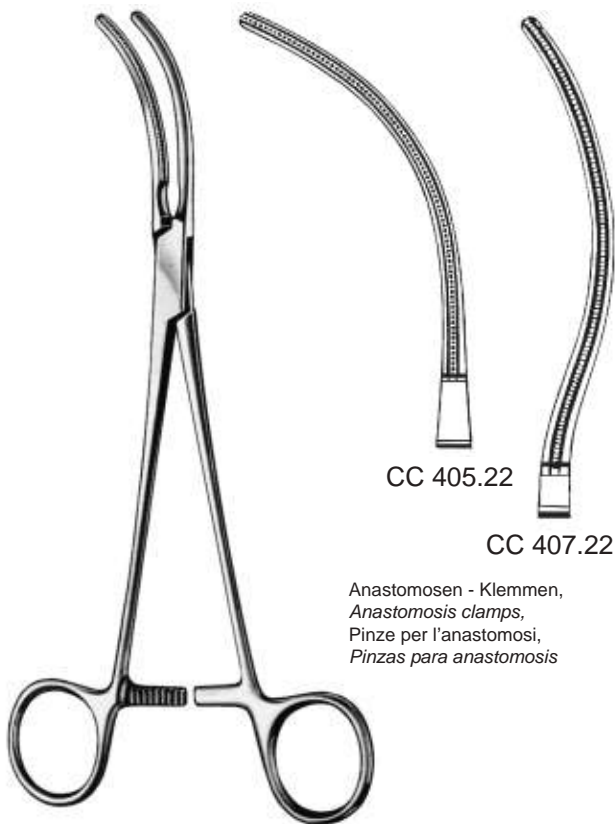

CC 405.22

CC 407.22

Anastomosen - Klemmen,
 Anastomosis clamps,
 Pinze per l'anastomosi,
 Pinzas para anastomosis

POTTS
 CC 405.22 - CC 407.22
 220mm / 8³/₄"

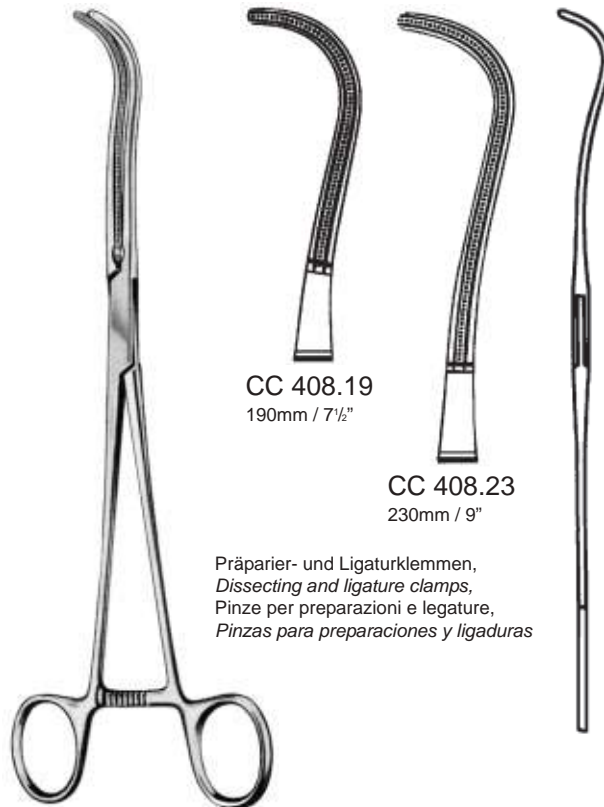

CC 408.19
 190mm / 7¹/₂"

CC 408.23
 230mm / 9"

Präparier- und Ligaturklemmen,
 Dissecting and ligature clamps,
 Pinze per preparazioni e legature,
 Pinzas para preparaciones y ligaduras

DE BAKEY
 CC 408.19 - CC 408.23



DE BAKEY
 CC 409.16
 160mm / 6¹/₂"

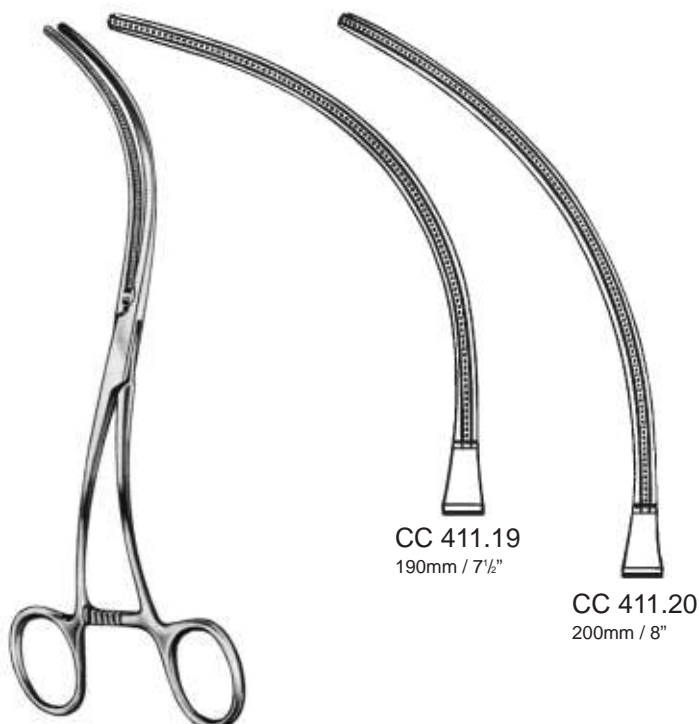

CC 411.19
 190mm / 7¹/₂"

CC 411.20
 200mm / 8"

DE BAKEY
 CC 411.19 - CC 411.20

Atraumatic - Cardiovascularclammen
Atraumatic - Cardiovascular Forceps
Atraumatic - Pinze cardiovascolari
Atraumatic - Pinzas - clamps cardiovasculares



Peripheral Gefäßklemmen, *Peripheral vascular clamps,*
 Pinze per vasi periferici, *Pinzas para vasos periféricos*

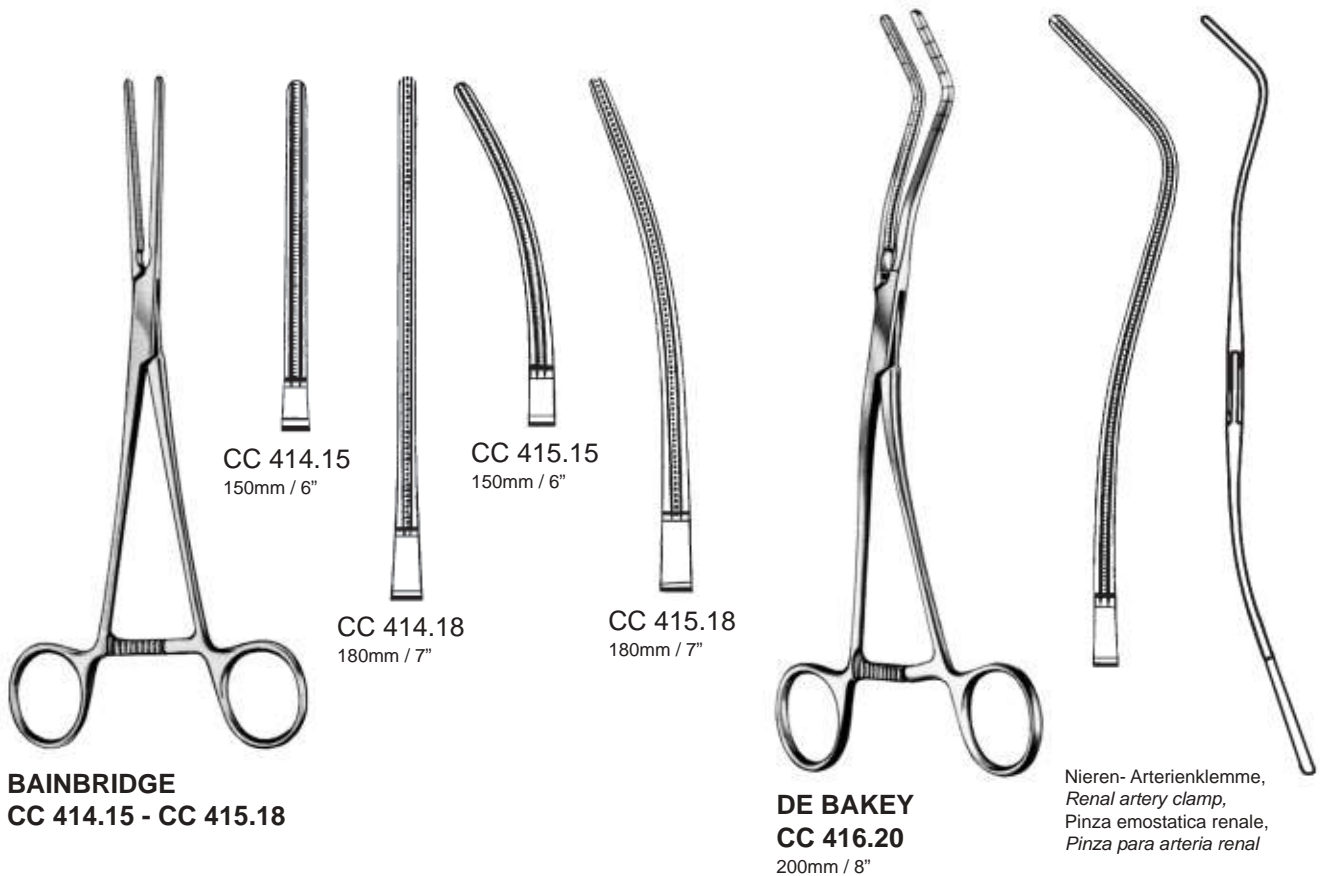
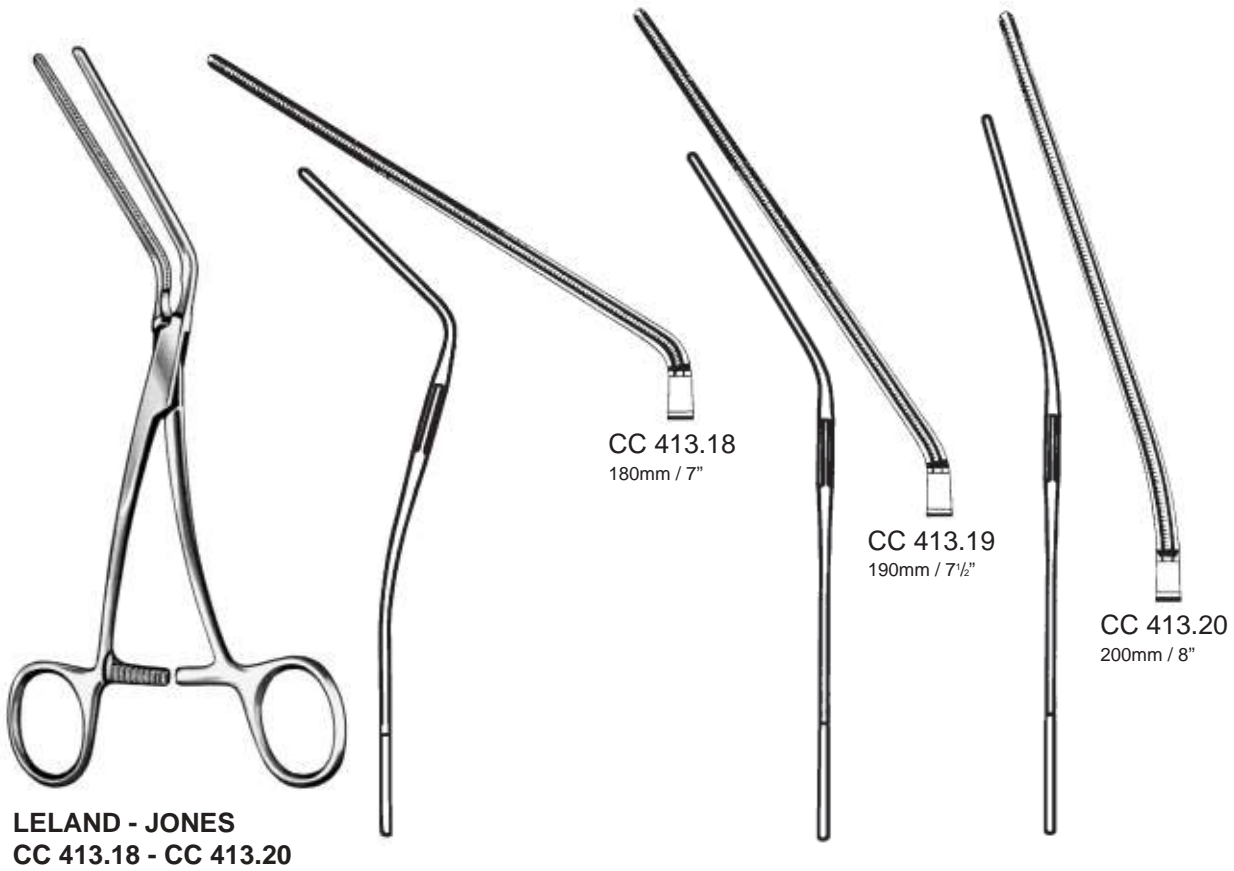



DE BAKEY
CC 417.26 - CC 417.33



CC 417.26
260mm / 10 1/4"



CC 417.27
270mm / 10 1/2"



CC 417.31
310mm / 12 1/4"



CC 417.33
330mm / 13"

Aorta- Aneurysmaklemmen, *Aortic aneurysm clamps,*
Pinze per l'aneurisma dell'aorta, *Pinzas para aneurisma de aorta*

Aorta- Aneurysmaklemmen, *Aortic aneurysm clamps*,
Pinze per l'aneurisma dell'aorta, *Pinzas para aneurisma de aorta*



DE BAKEY
CC 418.28
280mm / 11"



DE BAKEY
CC 419.30
300mm / 12"

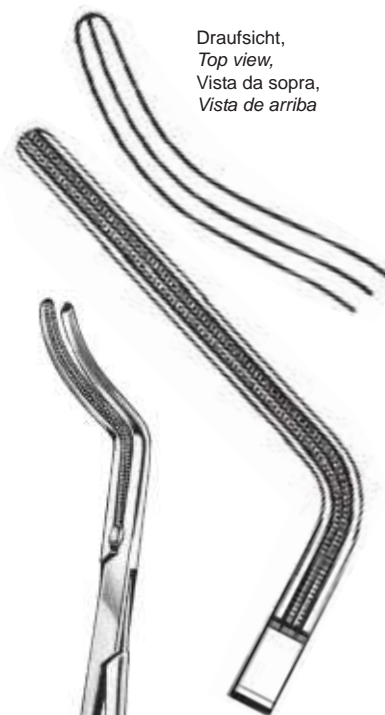

Draufsicht,
Top view,
Vista da sopra,
Vista de arriba



DE BAKEY
CC 420.27
270mm / 10½"

Aortaklemme, *Aortic clamps*,
Pinza per l'aorta, *Pinza para aorta*

Ligaturklemmen, *Ligature clamps,*
Pinze per legature, *Pinzas para ligaduras*

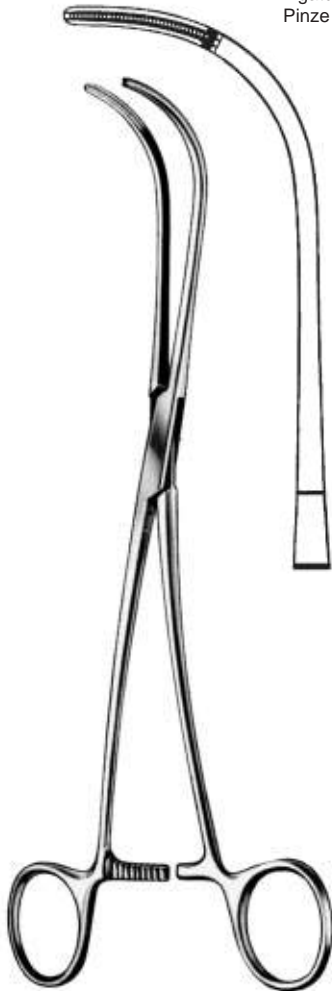

DE BAKEY
CC 421.24
240mm / 9½"



DE BAKEY
CC 422.24
240mm / 9½"

Aortaklemme, *Aortic clamps,*
Pinza per l'aorta, *Pinza para aorta*

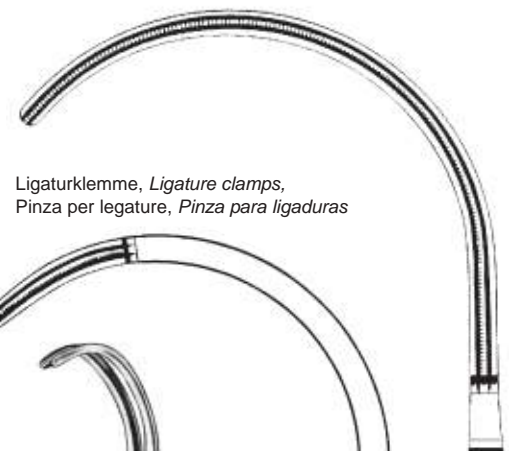

CC 423.26
260mm / 10¼"

Ligaturklemme, *Ligature clamps,*
Pinza per legature, *Pinza para ligaduras*



CC 423.25
250mm / 10"

DE BAKEY
CC 423.25 - CC 423.26



Aortaklemmen, *Aortic clamps*,
 Pinze per l'aorta, *Pinzas para aorta*

CC 424.01
 links, *left*,
 sinistra, *izquierda*

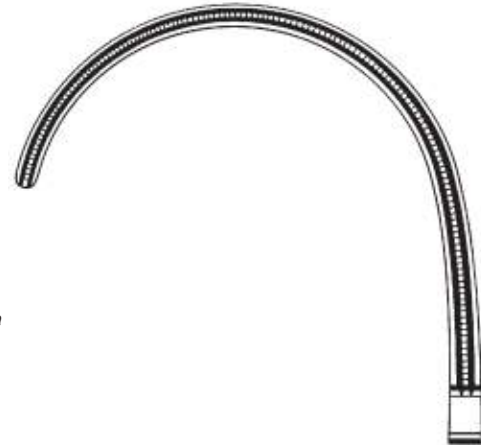
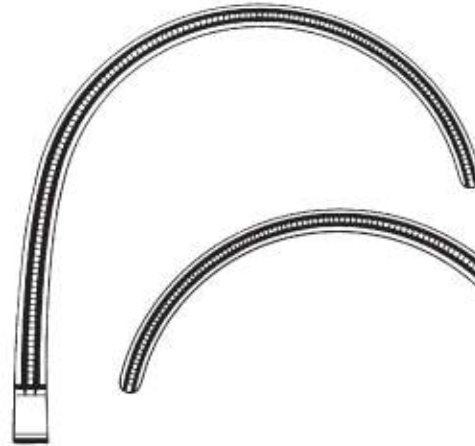

CC 424.02
 rechts, *right*,
 destra, *derecha*

WEBER
CC 424.01 - CC 424.02
 260mm / 10¹/₄"



SATINSKY / DE BAKEY
CC 425.20 - CC 425.28

Tagentialklemmen,
Tagential occlusion clamps,
 Pinze per l'occlusione tangenziale,
Pinzas para oclusión tangencial

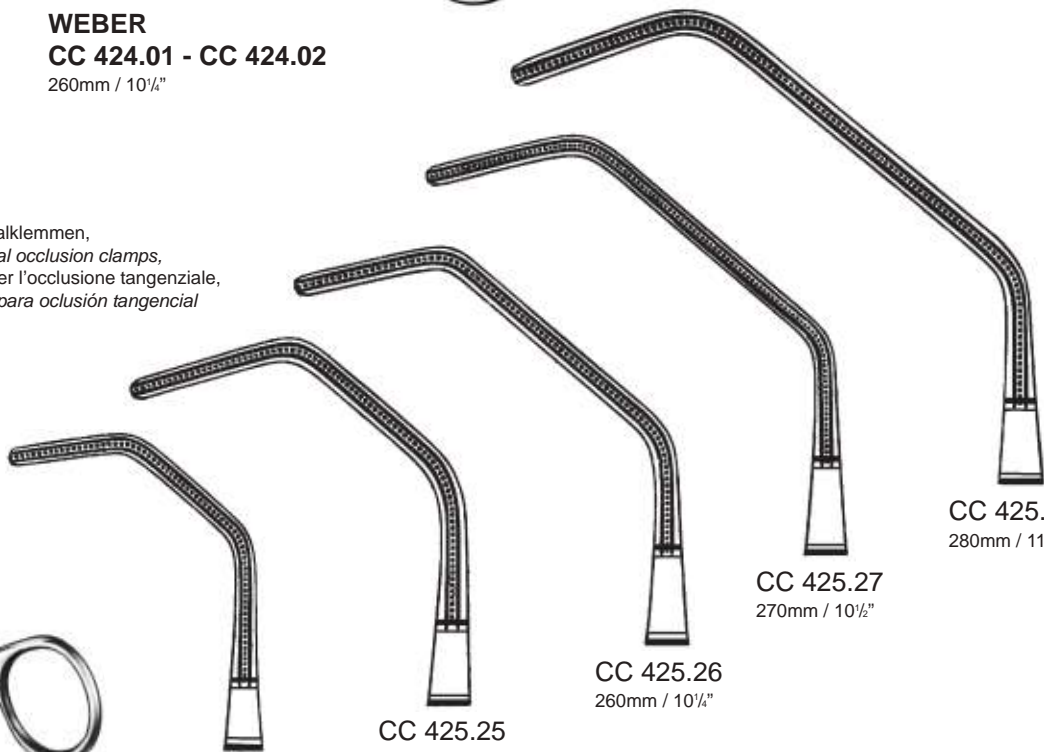

CC 425.20
 200mm / 8"

CC 425.25
 250mm / 10"

CC 425.26
 260mm / 10¹/₄"

CC 425.27
 270mm / 10¹/₂"

CC 425.28
 280mm / 11"

Atraumatic - Cardiovascularclammen
 Atraumatic - Cardiovascular Forceps
 Atraumatic - Pinze cardiovascolari
 Atraumatic - Pinzas - clamps cardiovasculares

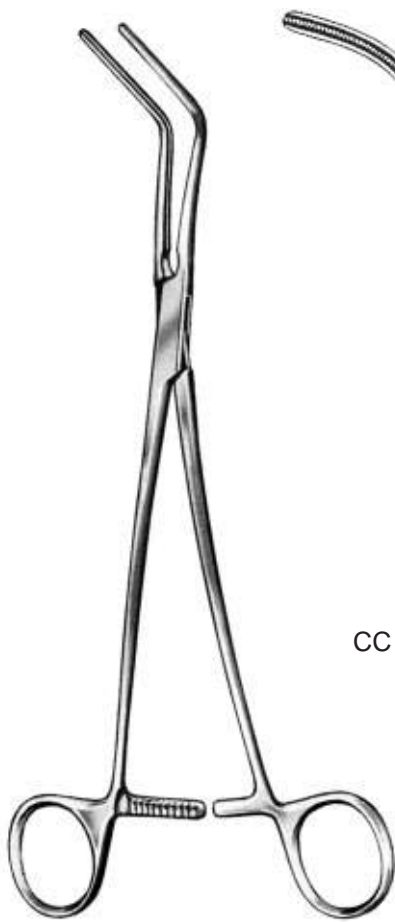

HARKEN
 CC 426.01 - CC 426.04
 240mm / 9½"



CC 426.01



CC 426.02



CC 426.03



CC 426.04

Aurikelclammen, Auricle clamps,
 Pinze auricolare, Pinzas auriculares



LEES
 CC 427.23 - CC 427.25

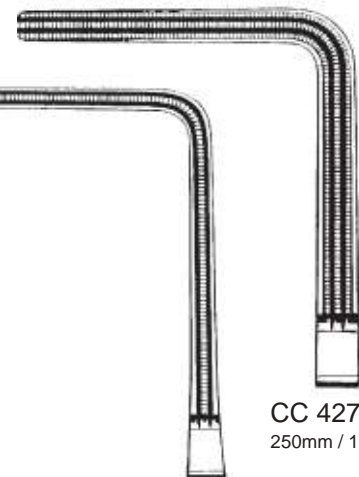

CC 427.25
 250mm / 10"

CC 427.23
 230mm / 9"

Bronchusklemmen, Bronchus clamps,
 Pinze per bronchi, Pinzas bronquiales

Atraumatic - Cardiovascularclammen
Atraumatic - Cardiovascular Forceps
Atraumatic - Pinze cardiovascolari
Atraumatic - Pinzas - clamps cardiovasculares



Bronchusklemme, *Bronchus clamps,*
 Pinza per bronchi, *Pinza bronquiales*



LEES
CC 429.25
 250mm / 10"

Aorta- Anastomosenclammen, *Aortic anastomosis clamps,*
 Pinze per l'anastomosi aorta, *Pinzas para anastomosis aorta*



LAMBERT - KAY
CC 430.21 - CC 430.22



CC 430.22
 220mm / 8 3/4"

CC 430.21
 210mm / 8 1/4"



DE BAKEY
CC 431.17
 170mm / 6 3/4"

Atraumatic - Cardiovascularclammen
Atraumatic - Cardiovascular Forceps
Atraumatic - Pinze cardiovascolari
Atraumatic - Pinzas - clamps cardiovasculares



Aortaklemmen, *Aortic clamps,*
 Pinze per l'aorta, *Pinzas para aorta*



MORRIS DE BAKEY
CC 432.18 - CC 432.25



CC 432.18
 180mm / 7"



CC 432.20
 200mm / 8"

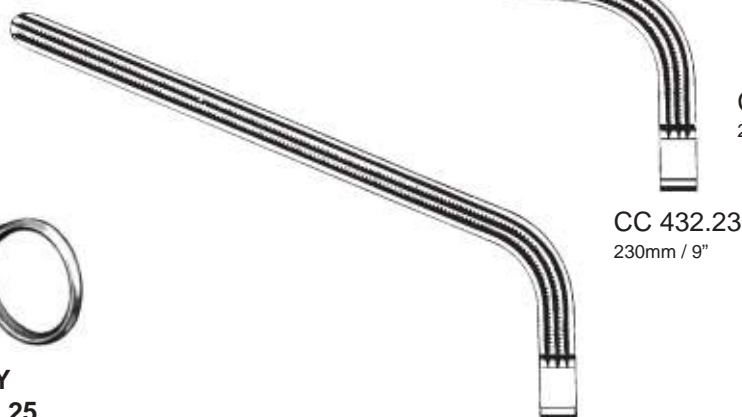

CC 432.23
 230mm / 9"

CC 432.25
 250mm / 10"



DE BAKEY - BAHNSON
CC 433.23 - CC 433.25



CC 433.23
 230mm / 9"



CC 433.24
 240mm / 9½"



CC 433.25
 250mm / 10"

Aorta- Aneurysmaklemmen, *Aortic aneurysm clamps,*
 Pinze per l'aneurisma dell'aorta, *Pinzas para aneurisma de aorta*

Coarctations - Klemmen, *Coarctation clamps*,
Pinze per coartazione, *Pinzas para coartación*



CC 434.21 - CC 435.31



CC 434.21
210mm / 8¼"



CC 434.23
230mm / 9"



CC 434.27
270mm / 10½"



CC 434.31
310mm / 12¼"



CC 435.21
210mm / 8¼"



CC 435.23
230mm / 9"



CC 435.27
270mm / 10½"



CC 435.31
310mm / 12¼"

Atraumatic - Cardiovascularclammen
Atraumatic - Cardiovascular Forceps
Atraumatic - Pinze cardiovascolari
Atraumatic - Pinzas - clamps cardiovasculares



Mehrzweckclammen, *Multi purpose clamps,*
 Pinze per vari usi, *Pinzas para usos varios*



DE BAKEY
CC 436.18 - CC 437.29

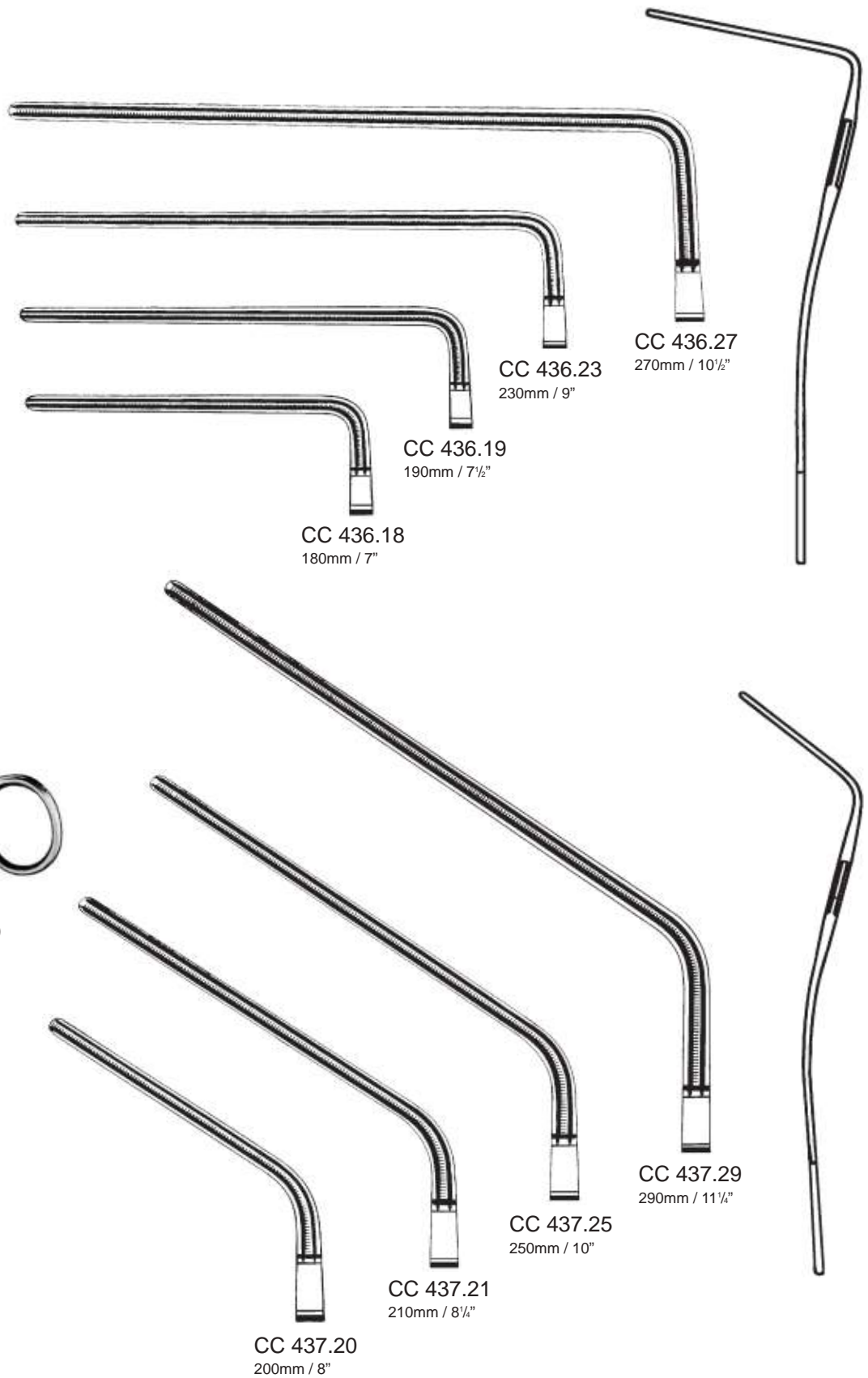



DE BAKEY - PEAN
CC 438.12 - CC 438.20

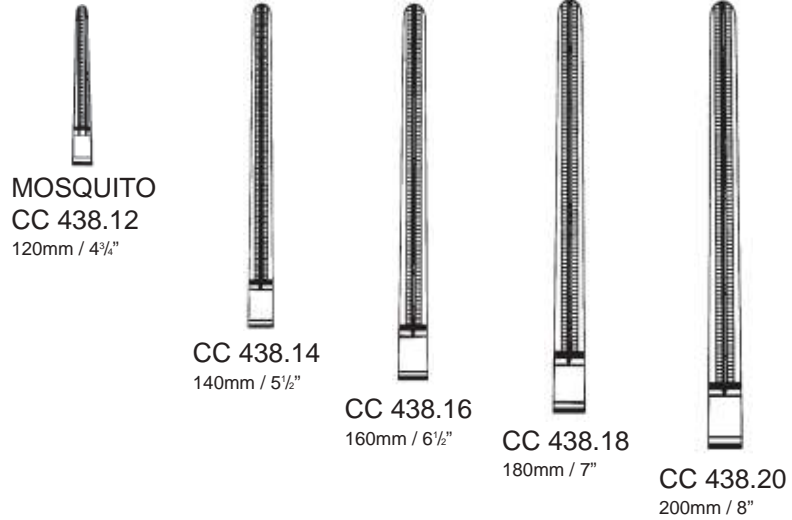

*Atraumatic - Arterienclammen, Atraumatic - Hemostatic clamps,
 Atraumatic - Pinze emostatiche, Atraumatic - Pinzas hemostáticas*



DE BAKEY - PEAN
CC 439.12 - CC 439.20

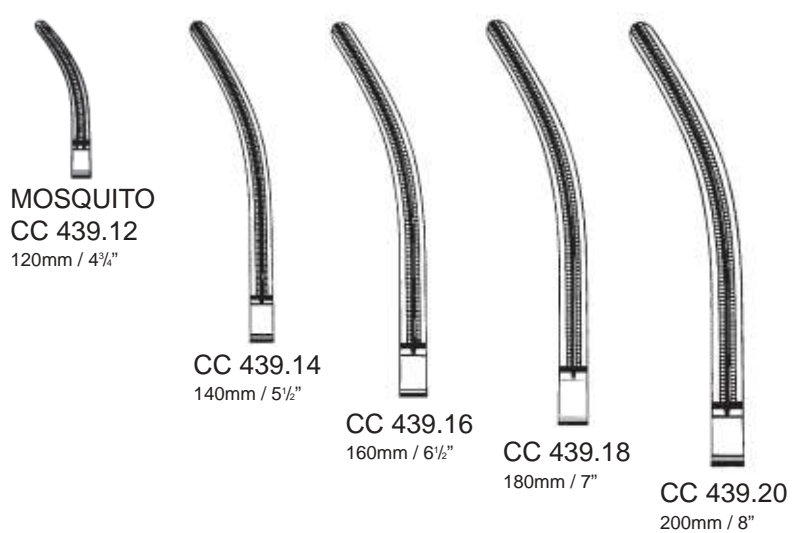

*Atraumatic - Arterienclammen, Atraumatic - Hemostatic clamps,
 Atraumatic - Pinze emostatiche, Atraumatic - Pinzas hemostáticas*



CC 440.17
 170mm / 6 3/4"



CC 441.16
 160mm / 6 1/2"



CC 443.15
 150mm / 6"



CC 445.15
 150mm / 6"



DE BAKEY (GLOVER)
 CC 440.17 - CC 451.17



CC 447.17
 170mm / 6 3/4"



GLOVER
 CC 449.17
 170mm / 6 3/4"



GLOVER
 CC 451.17
 170mm / 6 3/4"

Ligaturklemmen, *Ligature clamps*,
 Pinze per legature, *Pinzas para ligaduras*



CC 453.16 - CC 455.17

CC 453.16
160mm / 6 1/2"



CC 455.17
170mm / 6 3/4"

Anastomosenklemmen, *Anastomosis clamps*,
 Pinze per l'anastomosi, *Pinzas para anastomosis*



DERRA
CC 456.16 - CC 456.18

CC 456.16
160mm / 6 1/2"



CC 456.17
170mm / 6 3/4"



CC 456.18
180mm / 7"

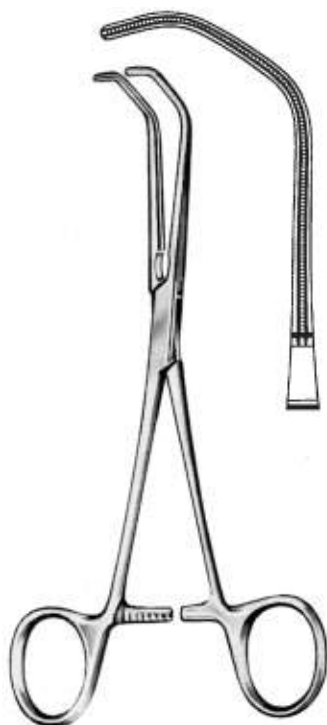

BECK
CC 457.17
170mm / 6 3/4"

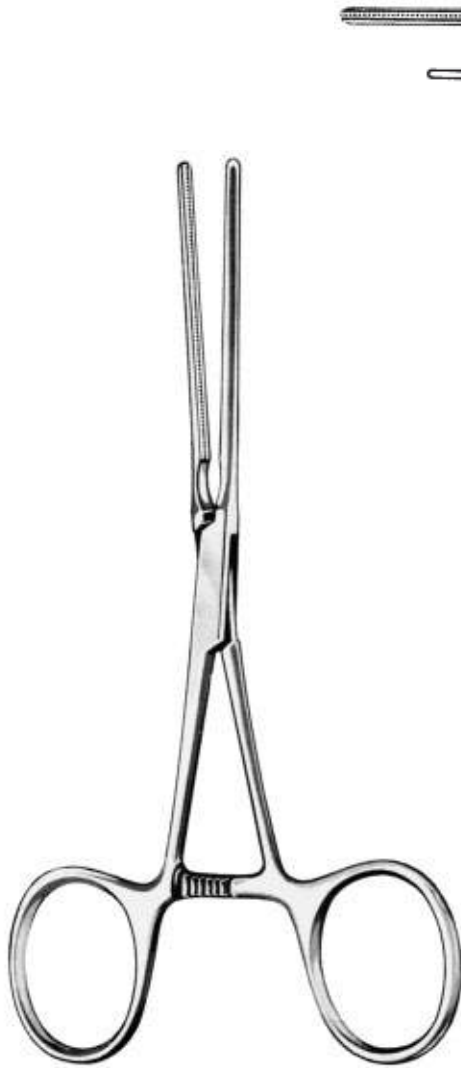

DE BAKEY
CC 458.10 - CC 459.13



CC 458.10
100mm / 4 $\frac{1}{4}$ "



CC 458.11
110mm / 4 $\frac{1}{2}$ "



CC 458.12
120mm / 4 $\frac{3}{4}$ "



CC 459.12
120mm / 4 $\frac{3}{4}$ "



CC 459.13
130mm / 5"



COOLEY
CC 466.01 - CC 466.05
 140mm / 5½"

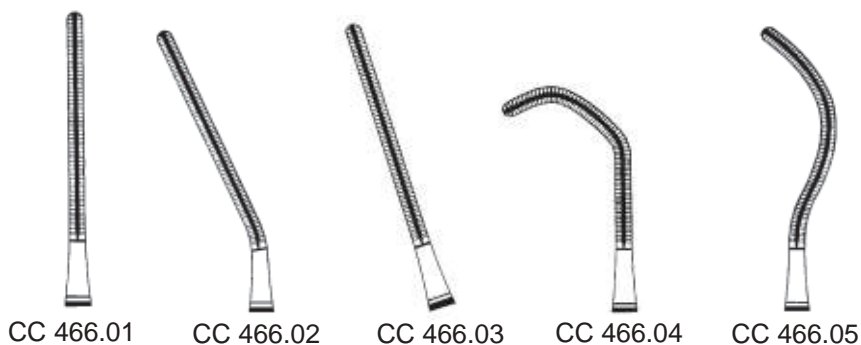

Kinderclammen, *Pediatric Clamps*,
 Pinze cardiovascolari per bambini, *Pinzas - clamps pediátricos*

Iliaca Klemme, *Iliac clamp*,
 Pinza iliaca, *Pinza para iliaca*

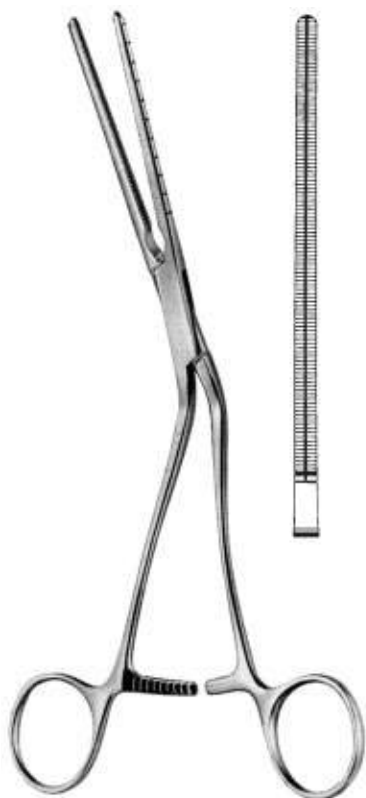

COOLEY
CC 467.21
 210mm / 8¼"



COOLEY
CC 468.17 - CC 476.17
 170mm / 6¾"

Coarctations - Klemmen, *Coarctation clamps*,
 Pinze per coartazione, *Pinzas para coartación*

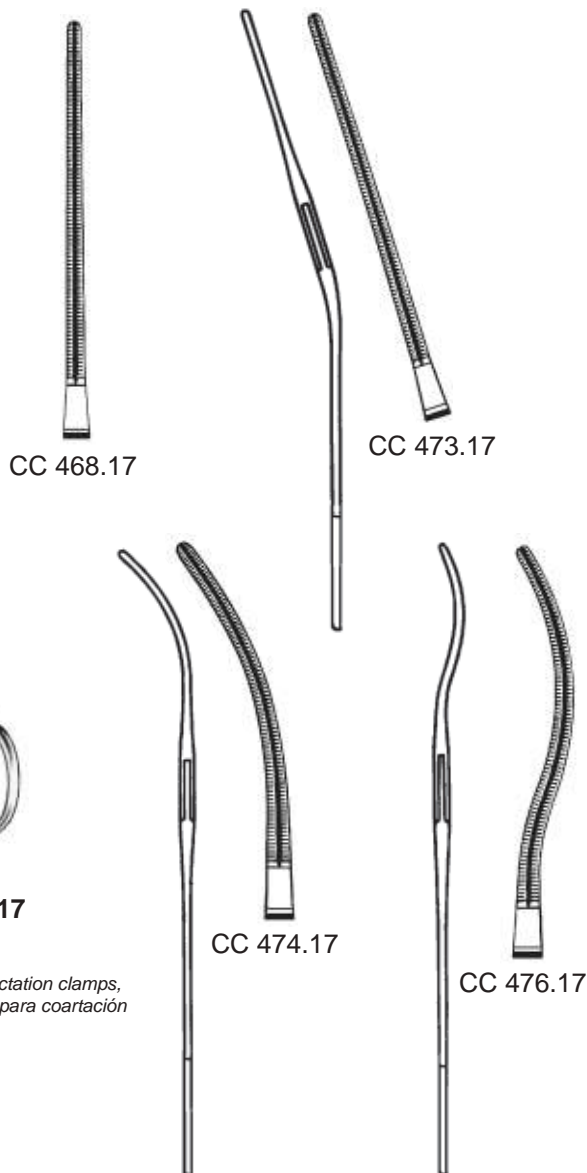



CC 469.20
200mm / 8"

CC 469.26
260mm / 10 1/4"

COOLEY
CC 469.20 - CC 469.26

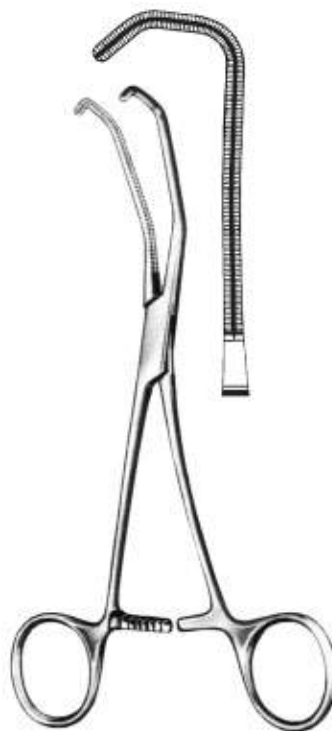

COOLEY
CC 470.17
170mm / 6 3/4"

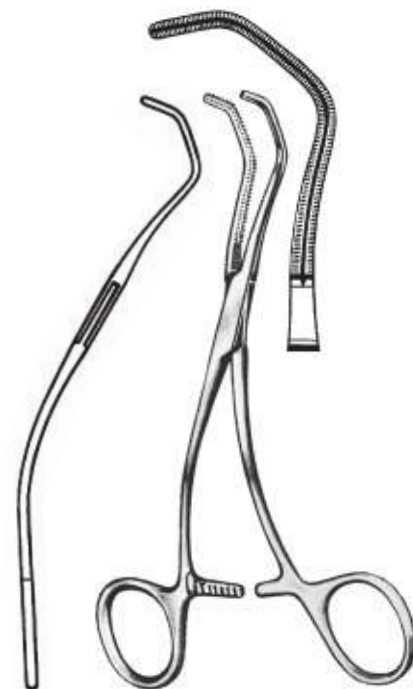

COOLEY
CC 471.16
160mm / 6 1/2"

Ligaturklemmen, *Ligature clamps,*
Pinze per legature, *Pinzas para ligaduras*

Mehrzweckklemmen, *Multi purpose clamps,*
Pinze per vari usi, *Pinzas para usos varios*



CC 472.15
150mm / 6"



CC 472.16
160mm / 6 1/2"



CC 472.17
170mm / 6 3/4"

COOLEY
CC 472.15 - CC 472.17

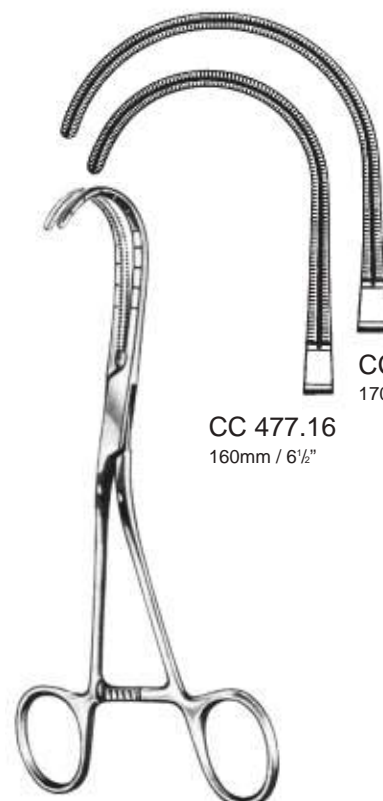

CC 477.16
160mm / 6 1/2"

CC 477.17
170mm / 6 3/4"

COOLEY
CC 477.16 - CC 477.17

Atraumatic - Cardiovascularclammen
Atraumatic - Cardiovascular Forceps
Atraumatic - Pinze cardiovascolari
Atraumatic - Pinzas - clamps cardiovasculares



Anastomosen- Klemmen, *Anastomosis clamps,*
 Pinze per l'anastomosi, *Pinzas para anastomosis*

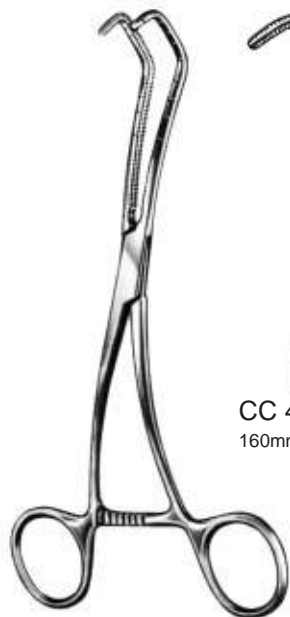

CC 478.16
 160mm / 6½"



CC 478.17
 170mm / 6¾"



CC 478.18
 180mm / 7"

COOLEY - DERRA
CC 478.16 - CC 478.18

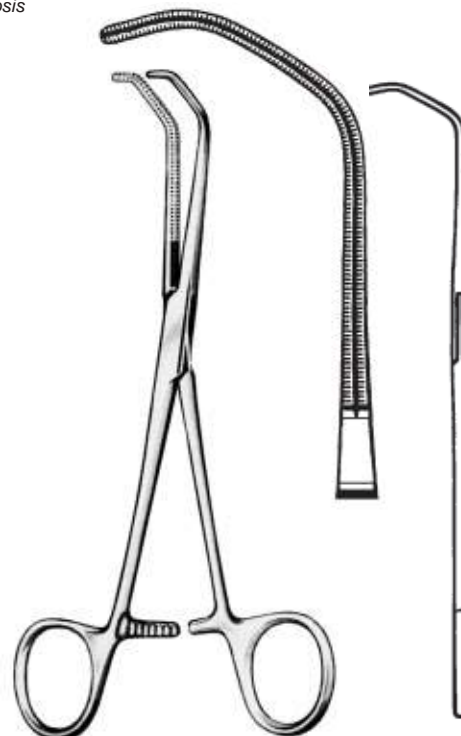

BECK
CC 479.17
 170mm / 6¾"



CC 527.01 - CC 527.02
 260mm / 10¼"



CC 527.01



CC 527.02

Tangentialklemmen, *Tangential occlusion clamps,*
 Pinze per l'occlusione tangenziale, *Pinzas para oclusión tangencial*

Neonatal- und Kinderclammen, *Neonatal and Pediatric clamps,*
 Pinze per neonati e bambini, *Pinzas pediátricos y para recién-nacidos*

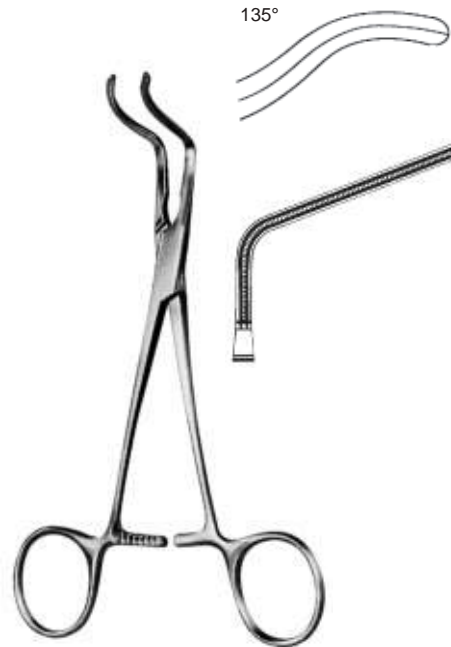

SUBRAMANIAN - MINIATURE
CC 559.15
 150mm / 6"

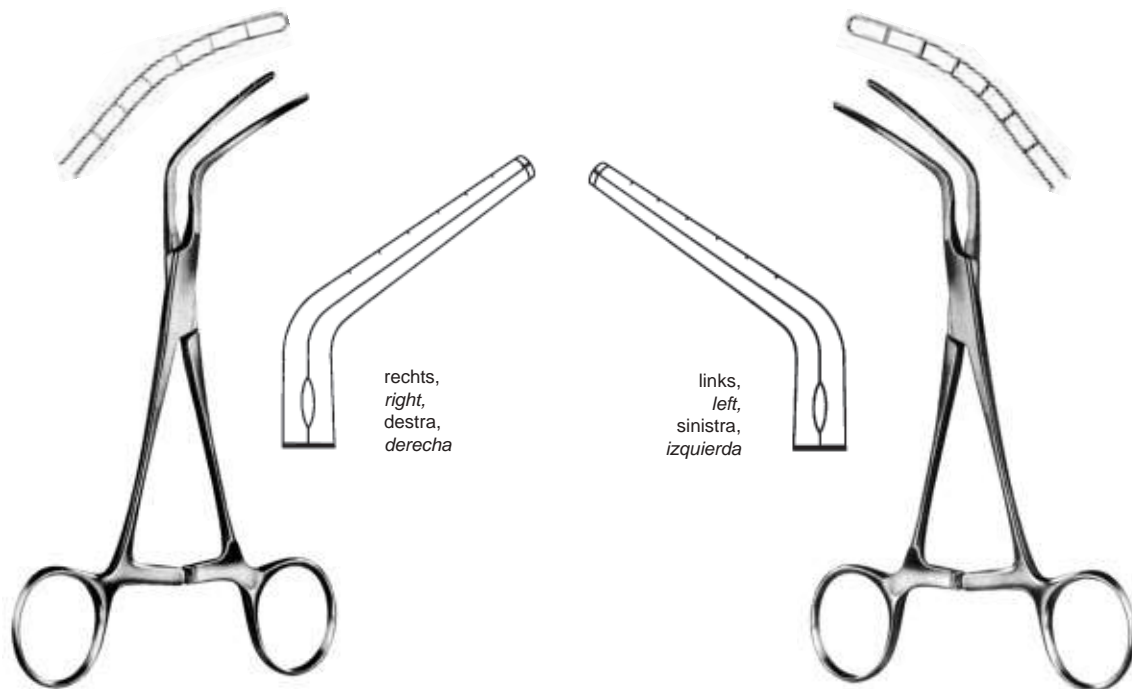

SUBRAMANIAN
CC 561.16
 160mm / 6½"

SUBRAMANIAN
CC 563.16
 160mm / 6½"

Aortaklappen, *Aortic clamps,*
 Pinze per l'aorta, *Pinzas para aorta*

Neonatal- und Kinderclennen, *Neonatal and Pediatric clamps,*
 Pinze per neonati e bambini, *Pinzas pediátricos y para recién-nacidos*



CC 570.01 - CC 570.09
CC 571.01 - CC 571.09
CC 573.01 - CC 573.09

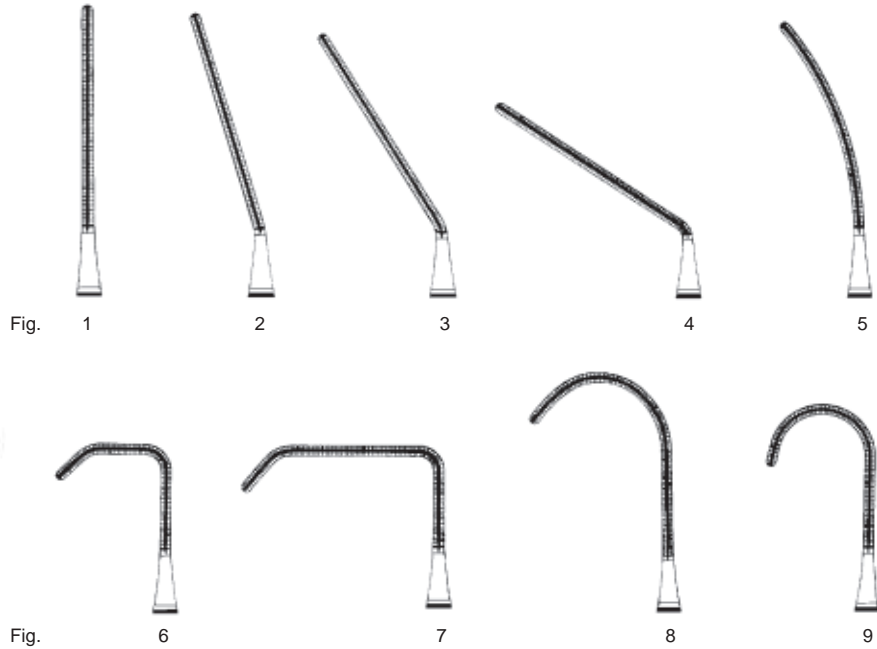

	gerade, straight, rette, rectas	
Fig. 1	CC 570.01 // 140mm / 5½"	
2	CC 570.02 // 140mm / 5½"	
3	CC 570.03 // 140mm / 5½"	
4	CC 570.04 // 130mm / 5"	
5	CC 570.05 // 130mm / 5"	
6	CC 570.06 // 130mm / 5"	
7	CC 570.07 // 130mm / 5"	
8	CC 570.08 // 140mm / 5½"	
9	CC 570.09 // 140mm / 5½"	

	abgewinkelt, angled, angolari, acodadas	
Fig. 1	CC 571.01 // 140mm / 5½"	
2	CC 571.02 // 140mm / 5½"	
3	CC 571.03 // 140mm / 5½"	
4	CC 571.04 // 130mm / 5"	
5	CC 571.05 // 130mm / 5"	
6	CC 571.06 // 130mm / 5"	
7	CC 571.07 // 130mm / 5"	
8	CC 571.08 // 140mm / 5½"	
9	CC 571.09 // 140mm / 5½"	

	gebogen, curved, curve, curvas	
Fig. 1	CC 573.01 // 140mm / 5½"	
2	CC 573.02 // 140mm / 5½"	
3	CC 573.03 // 140mm / 5½"	
4	CC 573.04 // 130mm / 5"	
5	CC 573.05 // 130mm / 5"	
6	CC 573.06 // 130mm / 5"	
7	CC 573.07 // 130mm / 5"	
8	CC 573.08 // 140mm / 5½"	
9	CC 573.09 // 140mm / 5½"	

Neonatal- und Kinderclammen, *Neonatal and Pediatric clamps,*
Pinze per neonati e bambini, *Pinzas pediátricos y para recién-nacidos*

Extrafeine Modelle, *Very delicate patterns,*
Modelli estremamente fini, *Modelos muy delicados*



CC 588.16
160mm / 6½"



CC 589.16
160mm / 6½"



CC 590.16
160mm / 6½"



CC 591.15
150mm / 6"



CC 592.16
160mm / 6½"

Neonatal- und Kinderclammen, *Neonatal and Pediatric clamps,*
Pinze per neonati e bambini, *Pinzas pediátricos y para recién-nacidos*

Extrfeine Modelle, *Very delicate patterns,*
Modelli estremamente fini, *Modelos muy delicados*



CASTANEDA
CC 593.01 - CC 595.04



CC 593.01
130mm / 5"



CC 593.02
130mm / 5"



CC 593.03
110mm / 4½"



CC 595.01
120mm / 4¾"

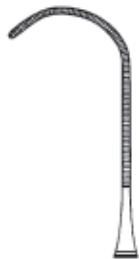

CC 595.02
120mm / 4¾"

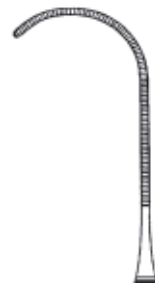

CC 595.03
120mm / 4¾"



CC 595.04
120mm / 4¾"

Rippensperrer aus Leichtmetall
Rib Spreader from Aluminium
Divaricatori costali in alluminio
Separadores costales de aluminio



Für Säuglinge
 For newborns
 Per neonati
 Para recién nacidos

COOLEY	a	b	c
CD 160.01	12mm	16mm	95mm

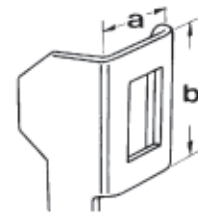

Größe der Valve,
 Size of blades,
 Dimensione della valva,
 Tamaño de la valva



Für Kinder
 For children
 Per bambini
 Para niños

COOLEY	a	b	c
CD 160.02	15mm	30mm	140mm

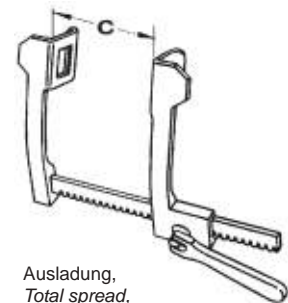

Ausladung,
 Total spread,
 Apertura totale,
 Apertura total

CD 160.03	21mm	44mm	150mm
-----------	------	------	-------



Für Erwachsene
 For adults
 Per adulti
 Para adultos

COOLEY	a	b	c
CD 160.04	35mm	50mm	200mm

Rippensperrer aus Leichtmetall
Rib Spreader from Aluminium
 Divaricatori costali in alluminio
 Separadores costales de aluminio

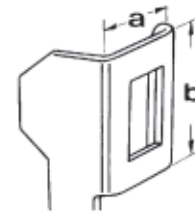
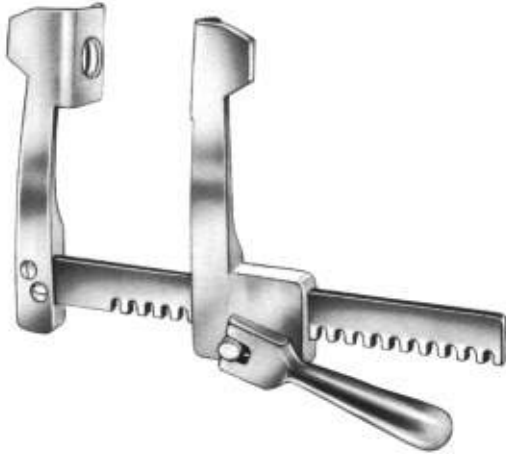

Größe der Valve,
 Size of blades,
 Dimensione della valva,
 Tamaño de la valva

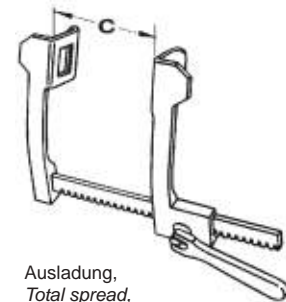

Ausladung,
 Total spread,
 Apertura totale,
 Apertura total

FINOCCHIETTO - BABY - HAIGHT

	a	b	c
CD 161.01	15mm	15mm	75mm

Für Säuglinge, *for newborns*, per neonati, *para recién nacidos*

CD 161.02	31mm	31mm	100mm
------------------	------	------	-------

Für Kinder, *for children*, per bambini, *para niños*

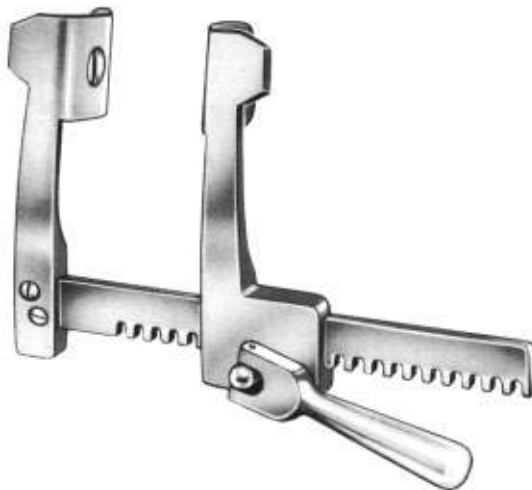

FINOCCHIETTO

	a	b	c
CD 163.01	40mm	45mm	135mm
CD 163.02	52mm	62mm	175mm
CD 163.03	84mm	65mm	175mm

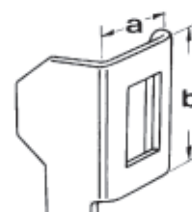
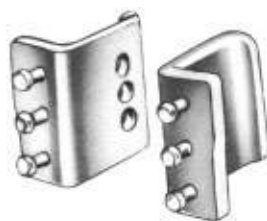

Größe der Valve,
Size of blades,
 Dimensione della valva,
Tamaño de la valva

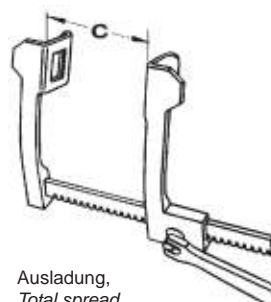

Ausladung,
Total spread,
 Apertura totale,
Apertura total

BURFORD

	a	b	c	
CD 164.00	48mm	42mm	135mm	Für Kinder, <i>for children,</i> Per bambini, <i>para niños</i>
	34mm	42mm	135mm	
CD 165.01	65mm	62mm	200mm	Für Erwachsene <i>For adults</i> Per adulti <i>Para adultos</i>
	47mm	62mm		
CD 165.02	65mm	62mm	250mm	
	47mm	62mm		
CD 165.03	65mm	62mm	300mm	
	47mm	62mm		

mit 2 Paar Valven, *with 2 pairs of blades,*
 con 2 paia di valve, *con 2 pares de valvas*



CASTAÑEDA

	a	b	c	
CD 166.01	10,5mm	32mm	65mm	Für Säuglinge, <i>for newborns,</i> per neonati, <i>para recién nacidos</i>
CD 166.02	12mm	45mm	70mm	Für Kinder, <i>for children,</i> per bambini, <i>para niños</i>
CD 166.03	15mm	60mm	120mm	Für Erwachsene, <i>for adults,</i> per adulti, <i>para adultos</i>



ALU

FINOCCHIETTO (MODIF.)

	a	b	c	d
CD 167.00	14mm	14mm	120mm	120mm

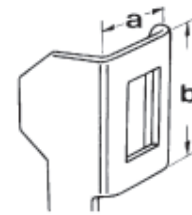

Größe der Valve,
Size of blades,
 Dimensione della valva,
Tamaño de la valva

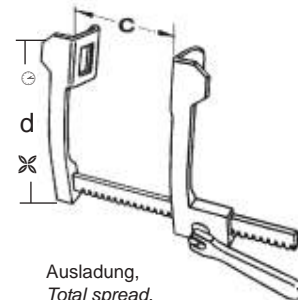

Ausladung,
Total spread,
 Apertura totale,
Apertura total



HAIGHT

	a	b	c
CD 168.00	30mm	30mm	90mm



ALU

MORSE - FAVALORO

	a	b	c	d
CD 169.00	17mm	22mm	160mm	120mm

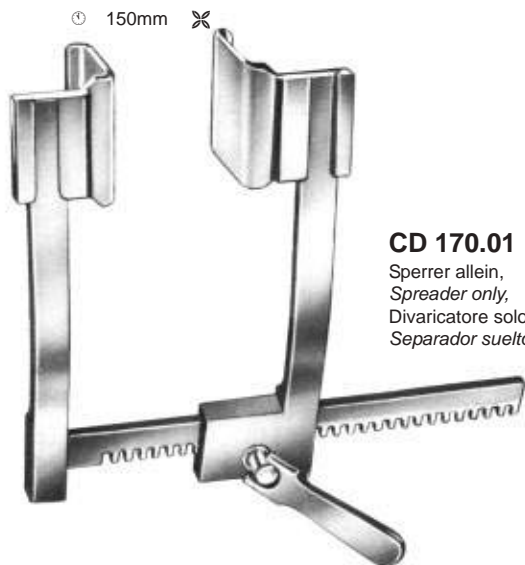

CD 170.01
 Sperrer allein,
Spreader only,
 Divaricatore solo,
Separador suelto

**DE BAKEY
 CD 170.00**

mit 3 Paar Valven, *with 3 pairs of blades,*
 con 3 paia di valve, *con 3 pares de valvas*



CD 170.02 // 30 x 30mm
 Valven, *Blades,* Valve, *Valvas*



CD 170.03 // 40 x 40mm
 Valven, *Blades,* Valve, *Valvas*



CD 170.04 // 50 x 50mm
 Valven, *Blades,* Valve, *Valvas*

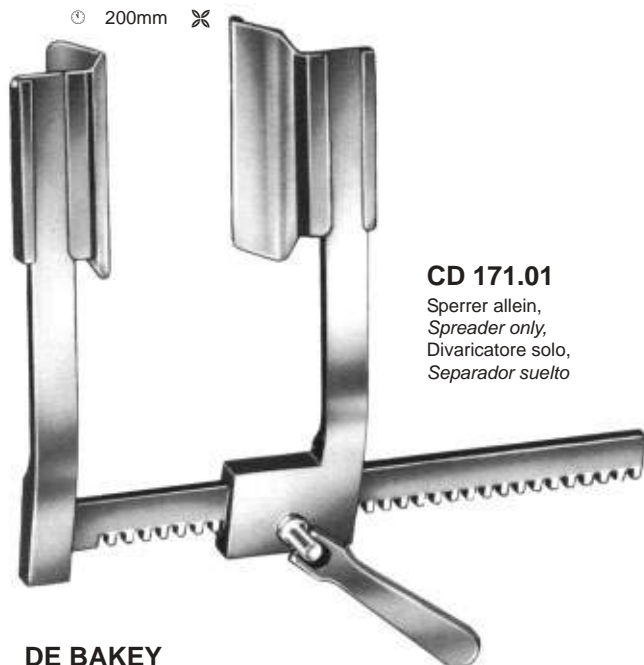

CD 171.01
 Sperrer allein,
Spreader only,
 Divaricatore solo,
Separador suelto

**DE BAKEY
 CD 171.00**

mit 3 Paar Valven, *with 3 pairs of blades,*
 con 3 paia di valve, *con 3 pares de valvas*



CD 171.02 // 60 x 60mm
 Valven, *Blades,* Valve, *Valvas*



CD 171.03 // 50 x 80mm
 Valven, *Blades,* Valve, *Valvas*



CD 171.04 // 40 x 100mm
 Valven, *Blades,* Valve, *Valvas*

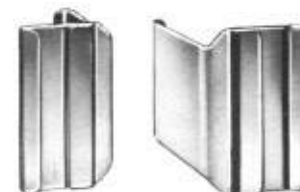

CD 171.05 // 80 x 60mm
 Valven, *Blades,* Valve, *Valvas*



CD 171.06 // 50 x 66mm
 Valven, *Blades,* Valve, *Valvas*

Rippensperrer
Rib Spreader
Divaricatori costali
Separadores costales



TUFFIER THÉODORE, * 1857, † 1929

Professor an der Fakultät der Medizin. War einer der ersten der sich mit der Lunge-, Herz- und Gefäßchirurgie konfrontierte.

Professor at the Faculty for Medicine. He was one of the first surgeons for lungs, heart and vascular surgery.

Professore ordinario alla Facoltà di Medicina. Fu tra i primi che affrontò la chirurgia del polmone, del cuore e dei vasi.

Profesor de la Facultad de Medicina. Fue uno de los primeros en afrontar la cirugía de pulmón, de corazón y vasos.

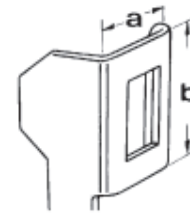

Größe der Valve,
 Size of blades,
 Dimensione della valva,
 Tamaño de la valva



TUFFIER

	a	b	c
CD 174.00	50mm	45mm	160mm

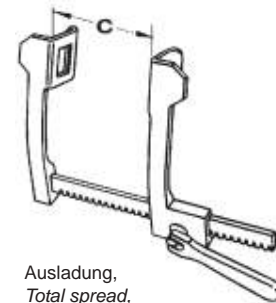

Ausladung,
 Total spread,
 Apertura totale,
 Apertura total

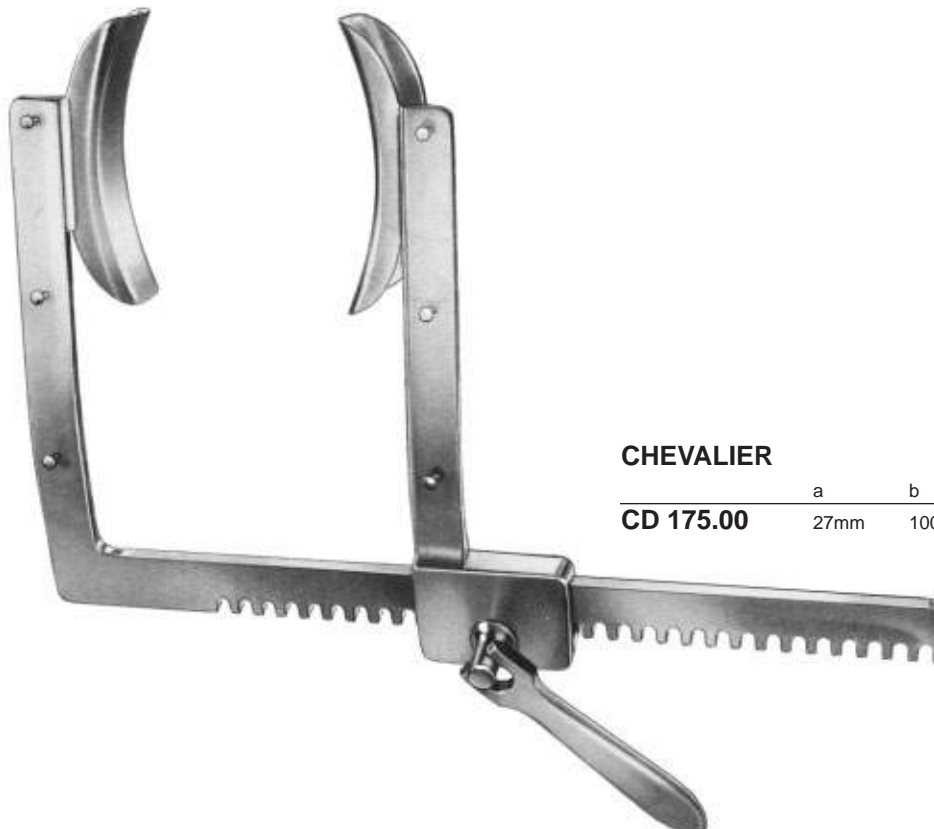

CHEVALIER

	a	b	c
CD 175.00	27mm	100mm	190mm

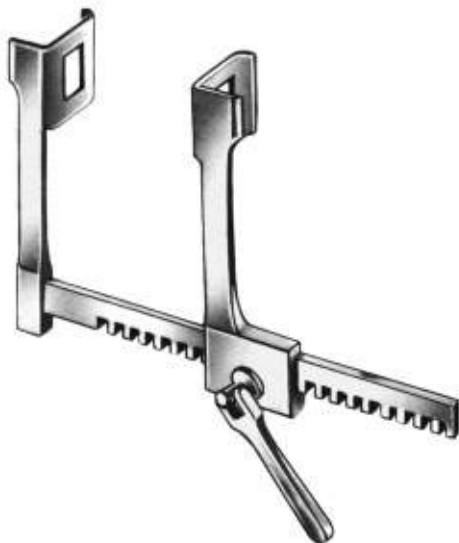

FINOCCHIETTO - BABY

	a	b	c
CD 177.00	14mm	15mm	75mm

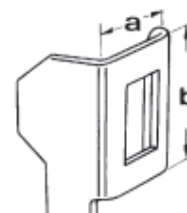

Größe der Valve,
Size of blades,
 Dimensione della valva,
Tamaño de la valva

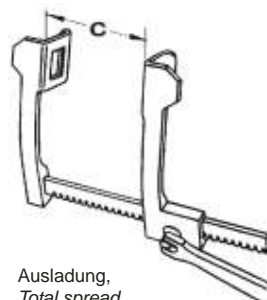
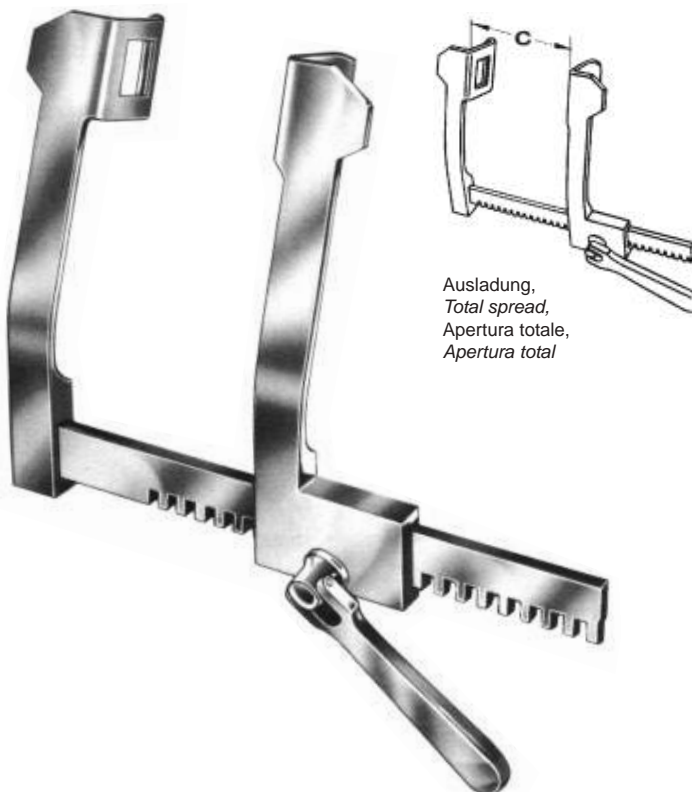

Ausladung,
Total spread,
 Apertura totale,
Apertura total

CD 191.75 // 75 x 75mm
 Valven, *Blades,* Valve, *Valvas*



MERCEDES (RETRACTOR)

CD 191.00

mit 2 Paar Valven, *with 2 pairs of blades,*
 con 2 paia di valve, *con 2 pares de valvas*

Thoraxsperrer, *Thoracic retractor,*
 Divaricatore per il torace, *Separador torácico*

CD 191.01
 Sperrer allein,
Spreader only,
 Divaricatore solo,
Separador suelto

CD 191.65 // 42 x 65mm
 Valven, *Blades,* Valve, *Valvas*



FINOCCHIETTO

	a	b	c
CD 178.01	30mm	45mm	150mm
CD 178.02	46mm	62mm	190mm
CD 178.03	80mm	65mm	190mm



SELLORS
CD 218.19
 190mm / 7½"



BAILEY - BABY
CD 220.14
 140mm / 5½"



BAILEY
CD 224.16
 160mm / 6½"



BAILEY - GIBBON
CD 226.16
 160mm / 6½"



ALLISON
CD 231.30 // 300mm / 12"
CD 231.32 // 320mm / 12½"

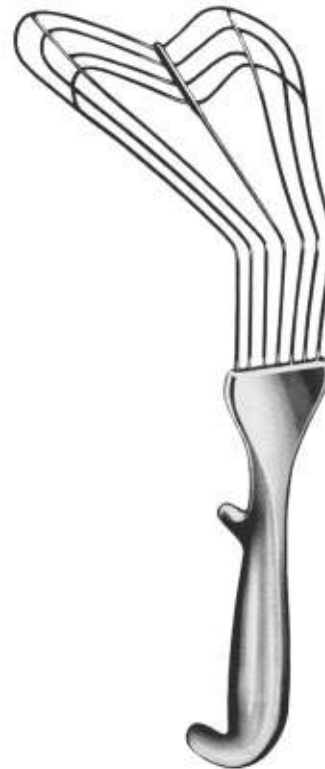

CD 233.26
 260mm / 10¼"

Intima Spatel
Intima Spatula
Spatole per la intima
Espátulas para la íntima

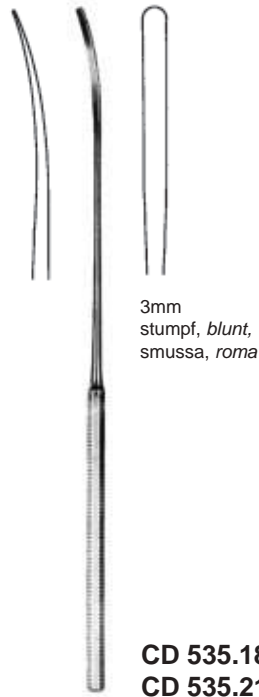

3mm
 stumpf, *blunt*,
 smussa, *roma*

CD 535.18 // 180mm / 7"
CD 535.21 // 210mm / 8¼"

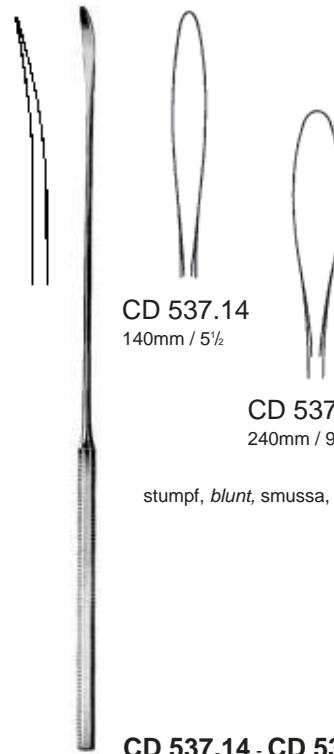

CD 537.14
 140mm / 5½"

CD 537.24
 240mm / 9½"

stumpf, *blunt*, smussa, *roma*

CD 537.14 - CD 537.24



5mm

2,5mm

ROBB
CD 539.01
 240mm / 9½"



4mm

2mm

ROBB
CD 539.02
 240mm / 9½"



3mm

1,5mm

ROBB
CD 539.03
 240mm / 9½"



2mm

1mm

ROBB
CD 539.04
 240mm / 9½"

Für Mitralstenosen, *for mitral valve,*
per stenosi mitrali, *para estenosis mitral*

Spreizweite: 8-42mm,
Blade opening: 8-42mm,
Apertura: 8-42mm,
Abertura: 8-42mm

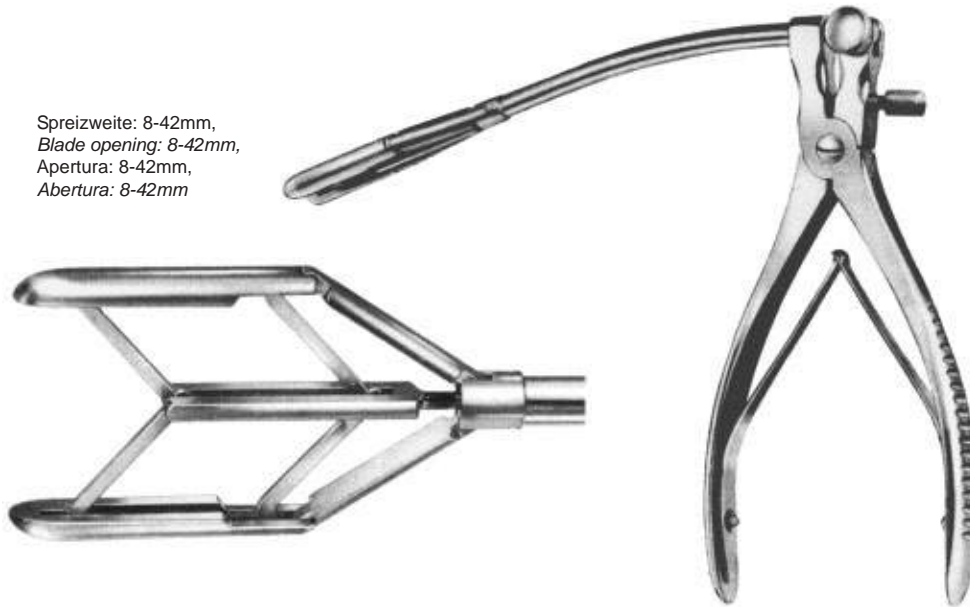

TUBBS
CV 482.00

Für Mitralstenosen (Kinder), *for mitral valve (pediatric),*
per stenosi mitrali (bambini), *para estenosis mitral (niños)*

Spreizweite: 8-15mm,
Blade opening: 8-15mm,
Apertura: 8-15mm,
Abertura: 8-15mm

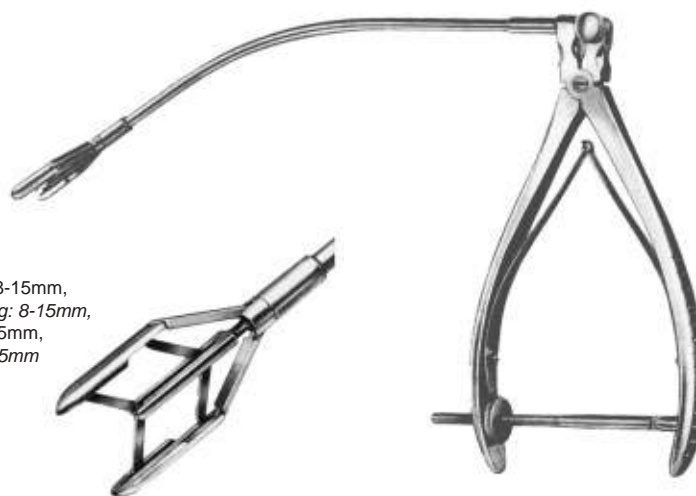

COOLEY
CV 484.00

Gefäß - Dilatoren
Vascular Dilators
Dilatatori vascolari
Dilatadores vasculares

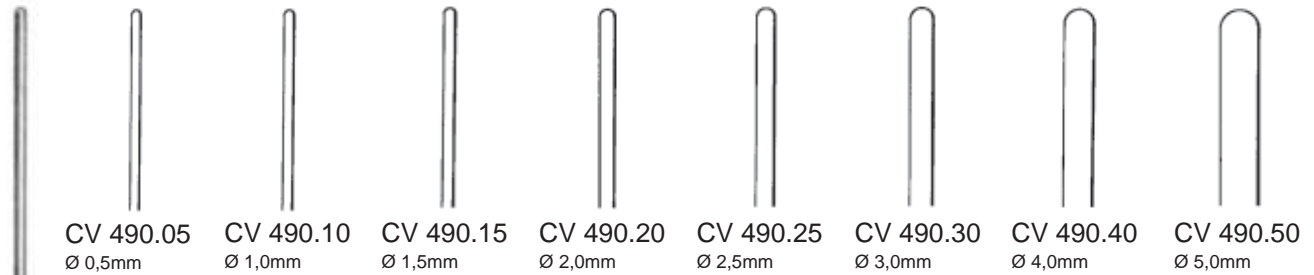

CV 490.05 Ø 0,5mm CV 490.10 Ø 1,0mm CV 490.15 Ø 1,5mm CV 490.20 Ø 2,0mm CV 490.25 Ø 2,5mm CV 490.30 Ø 3,0mm CV 490.40 Ø 4,0mm CV 490.50 Ø 5,0mm

biegsam, malleable, malleabili, maleables

COOLEY
CV 490.05 - CV 490.50
 130mm / 5"

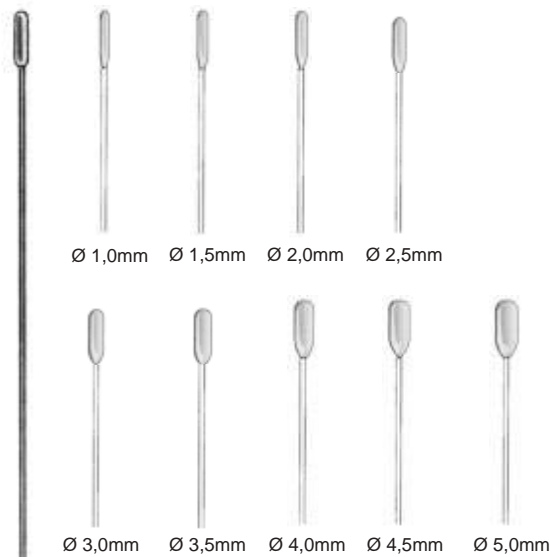

Ø 1,0mm Ø 1,5mm Ø 2,0mm Ø 2,5mm
 Ø 3,0mm Ø 3,5mm Ø 4,0mm Ø 4,5mm Ø 5,0mm

140mm / 5½"	210mm / 8¼"	Ø
CV 495.10	CV 496.10	1,0mm
CV 495.15	CV 496.15	1,5mm
CV 495.20	CV 496.20	2,0mm
CV 495.25	CV 496.25	2,5mm
CV 495.30	CV 496.30	3,0mm
CV 495.35	CV 496.35	3,5mm
CV 495.40	CV 496.40	4,0mm
CV 495.45	CV 496.45	4,5mm
CV 495.50	CV 496.50	5,0mm

biegsam, malleable, malleabili, maleables

GARRETT
CV 495.10 - CV 495.50
CV 496.10 - CV 496.50

190mm / 7½"	350mm / 14"	Ø
CV 492.05	CV 494.05	0,5mm
CV 492.10	CV 494.10	1,0mm
CV 492.15	CV 494.15	1,5mm
CV 492.20	CV 494.20	2,0mm
CV 492.25	CV 494.25	2,5mm
CV 492.30	CV 494.30	3,0mm
CV 492.35	CV 494.35	3,5mm
CV 492.40	CV 494.40	4,0mm
CV 492.45	CV 494.45	4,5mm
CV 492.50	CV 494.50	5,0mm
CV 492.70	CV 494.70	7,0mm
CV 492.90	CV 494.90	9,0mm

biegsam, malleable, malleabili, maleables

DE BAKEY
CV 492.05 - CV 492.90
CV 494.05 - CV 494.90



CV 550.15 - CV 550.30
 260mm / 10"



CV 550.15
 1,5mm



CV 550.20
 2,0mm



CV 550.25
 2,5mm



CV 550.30
 3,0mm



biegsam, malleable,
 malleabili, maleables

RUMEL - BELMONT
CV 556.33 // Ø 3,2mm
CV 558.33 // Ø 6,4mm
 330mm / 13"



VOLLMAR
CY 691.15 - CY 691.40

- CY 691.15 // Ø 1,5mm
- CY 691.20 // Ø 2,0mm
- CY 691.25 // Ø 2,5mm
- CY 691.30 // Ø 3,0mm
- CY 691.40 // Ø 4,0mm



SCHMID
CY 695.03 - CY 695.06
 150mm / 6"



CY 695.03
 Ø 3,0mm



CY 695.04
 Ø 4,0mm



CY 695.05
 Ø 5,0mm



CY 695.06
 Ø 6,0mm

biegsam, malleable, malleabili, maleables



MOCK
CY 696.06
 60mm / 2 1/4"



GYNÄKOLOGIE, GEBURTSHILFE
GYNECOLOGY, OBSTETRICS
GINECOLOGIA, OSTETRICIA
GINECOLOGIA, OBSTETRICIA

Myom- und Konusmesser, Fistelhaken, Myomheber
Myoma and Cone Knives, Fistula Hooks, Myoma Srew
Bisturi per fibromi e per il cono d'attrazione, Uncini per fistole
Bisturías para fibroma y para cono de atracción, Ganchos para fistula



SEGOND
GA 762.27
270mm / 10½"



AYRE
GA 801.23
230mm / 9"



SIMON
GD 806.22
220mm / 8¾"



SIMON
GD 808.22
220mm / 8¾"

Myomheber, Myoma Srew,
Strumenti per fibromi, *Tiramiomas para fibroma*



DOYEN
GO 757.17
170mm / 6¾"



DOYEN
GO 759.14
170mm / 6¾"

Hakenzangen
Tenaculum Forceps
Pinze per abbassare il collo dell'utero
Pinzas para coger el cuello del útero



STAUDE - MOORE
GF 614.17
170mm / 6 $\frac{3}{4}$ "



BARRETT
GF 616.18
180mm / 7"



BRAUN
GF 628.25
250mm / 10"



DUPLAY
GF 645.28
280mm / 11"



BEACHAM
GF 659.26
260mm / 10 $\frac{1}{4}$ "

*Amniotom für die Amnioblase,
Amniotome for the amnion bladder,
Amniotomo per la vescica amniotica,
Amniótomo para la vesícula amniótica*

Hakenzangen
Tenaculum Forceps
Pinze per abbassare il collo dell'utero
Pinzas para coger el cuello del útero



SKENE
GF 663.24
240mm / 9½"



SCHROEDER
GF 682.24 - GF 683.24
240mm / 9½"

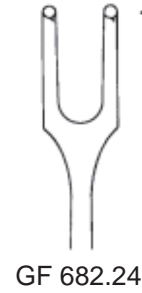

GF 682.24



GF 683.24



TEALE
GF 697.23
230mm / 9"

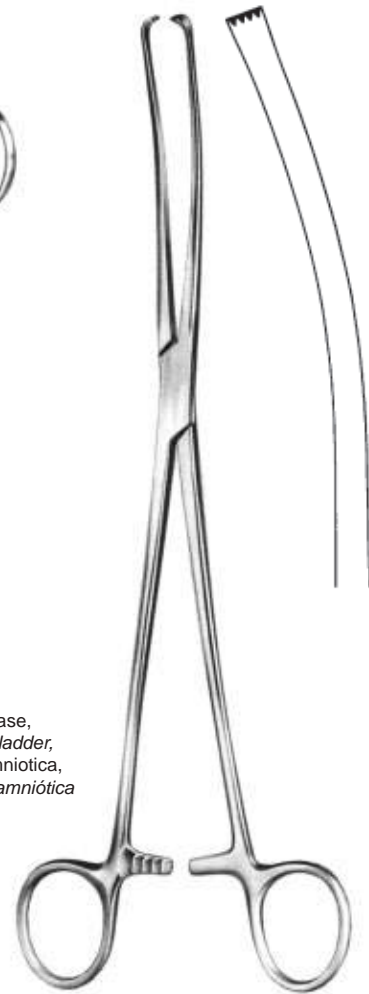

Für die Amnionblase,
For the amnion bladder,
Per la vescica amniotica,
Para la vesícula amniótica

IOWA
GF 699.26
260mm / 10¼"

Hakenzangen
Tenaculum Forceps
Pinze per abbassare il collo dell'utero
Pinzas para coger el cuello del útero



JACOBS
GF 728.21
210mm / 8 1/4"

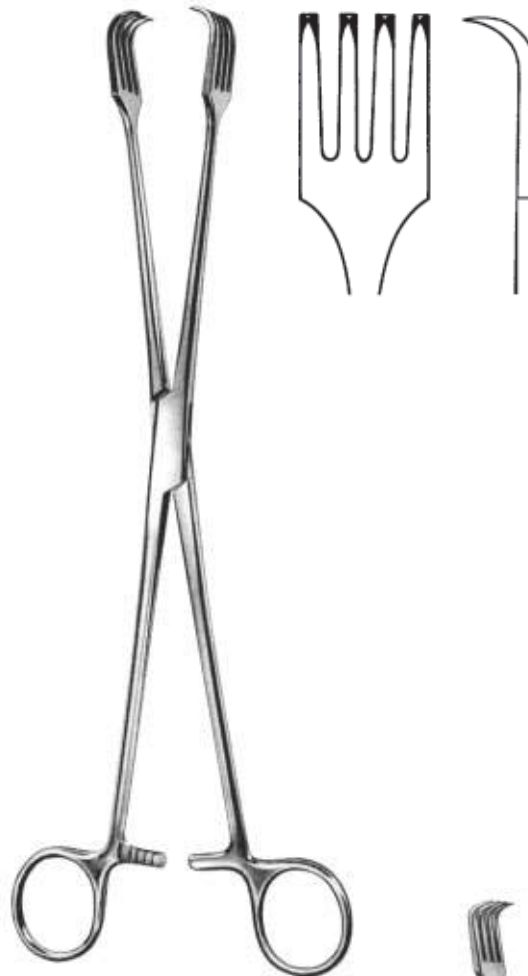

GF 734.26
260mm / 10 1/4"



BRAUN
GF 738.16
160mm / 6 1/2"



CZERNY
GF 740.21
210mm / 8 1/4"

Uterus- Polypenzangen, Uterus- Faßzangen
Uterine Polypus Forceps, Uterine Elevating Forceps
Pinze per polipi uterini, Pinze per afferrare l'utero
Pinzas para pólipos uterinos, Pinzas para el útero



KELLY
GF 741.32
320mm / 12½"



NOTO
GF 744.27
270mm / 10½"



DOYEN
GF 756.20
200mm / 8"



DARTIGUES
GF 773.27
270mm / 10½"



SOMER
GF 779.23
230mm / 9"



COLLIN
GF 793.25
250mm / 10"

Uterus- Biopsiezangen
 Cervical Biopsy and Specimen Forceps
 Pinze taglianti per biopsia
 Pinzas para biopsia



GELLHORN
GF 841.23
 230mm / 9"



FAURE
GF 843.21
 210mm / 8 1/4"



SCHUBERT
GF 846.21 // 210mm / 8 1/4"
GF 846.28 // 280mm / 11"



THOMS - GAYLOR
GF 851.22 // 220mm / 8 3/4"
GF 851.24 // 240mm / 9 1/2"



SCHUBERT
GF 853.26
 260mm / 10 1/4"



VAN DOREN
GF 855.24
 240mm / 9 1/2"



VAN DOREN
GF 855.25
 250mm / 10"

Uterus- Biopsiezangen
Cervical Biopsy and Specimen Forceps
Pinze taglienti per biopsia
Pinzas para biopsia

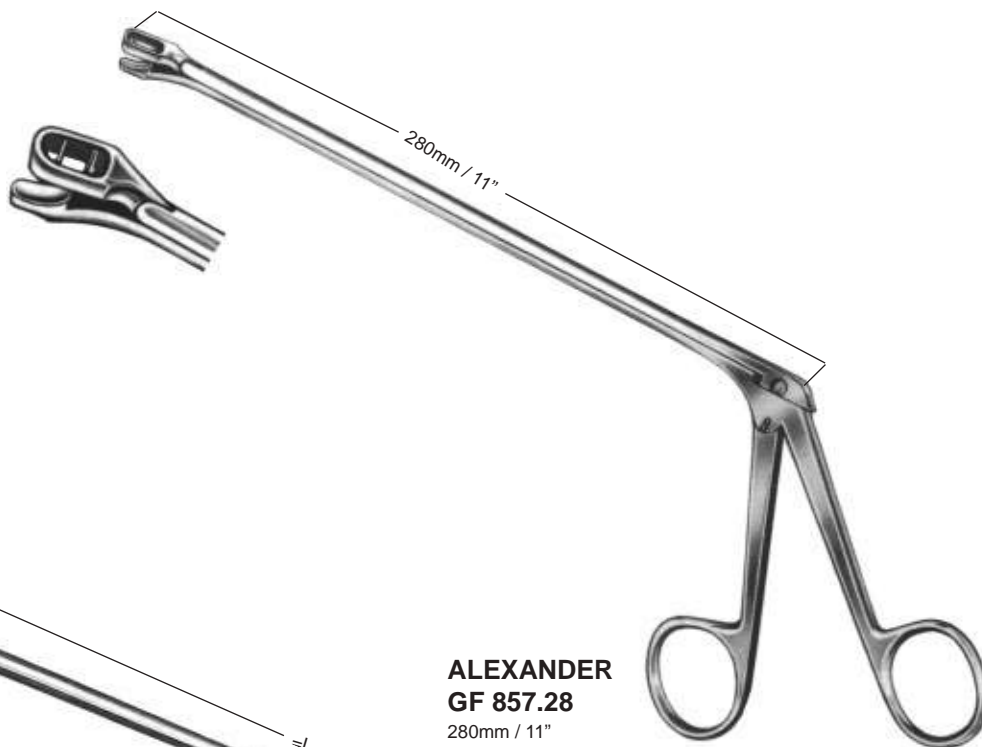

ALEXANDER
GF 857.28
 280mm / 11"

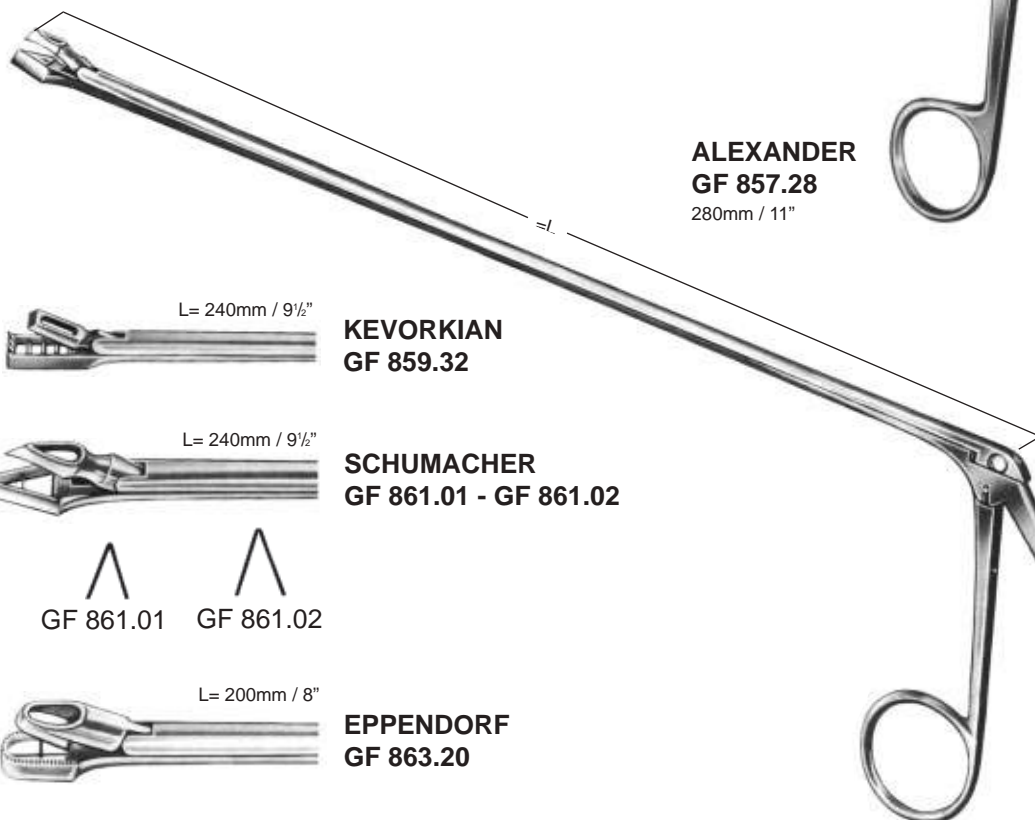

L= 240mm / 9 1/2"

KEVORKIAN
GF 859.32

L= 240mm / 9 1/2"

SCHUMACHER
GF 861.01 - GF 861.02



GF 861.01

GF 861.02

L= 200mm / 8"



EPPENDORF
GF 863.20



GF 865.01
 Aufsatz allein, *Tip only,*
 Punta sola, *Punta suelta*

SCHUMACHER
GF 865.00 - GF 865.01



RANDALL
GK 821.24
240mm / 9½"



NOVAK
GK 825.23
230mm / 9"



KEVORKIAN
GK 827.30
300mm / 12"



MOD. MUENCHEN
GK 829.27
270mm / 10½"



scharf, fest
sharp, rigid
 taglienti, rigidi
cortantes, rigidas

SIMON
GK 900.01 - GK 900.06
 240mm / 9½"



scharf, fest
sharp, rigid
 taglienti, rigidi
cortantes, rigidas

SCHRÖDER
GK 906.01 - GK 906.06
 300mm / 12"

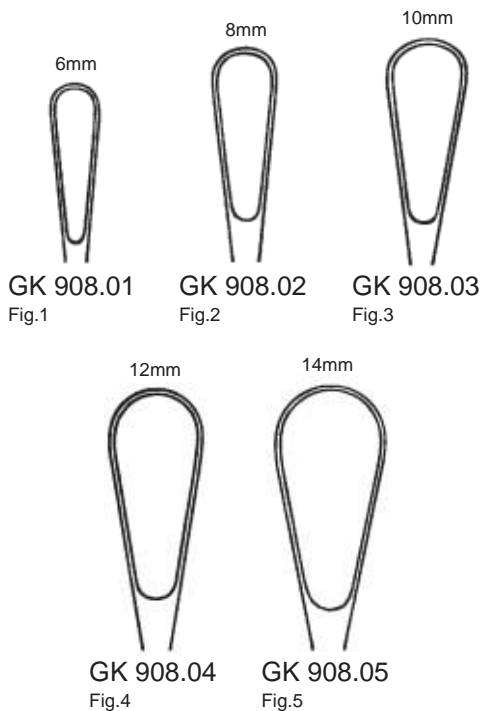

GOURDET
GK 908.01 - GK 908.05
 280mm / 11"



GK 916.01
 Fig.1 / 10mm
GK 916.02
 Fig.2 / 12mm
GK 916.03
 Fig.3 / 14mm

GREENE
GK 916.01 - GK 916.03
 280mm / 11"

RÉCAMIER JOSEPH CLAUDE ANTHELME ; * 1774

Wird als Gründer der Gynäkologie angesehen.

Is know as the founder of the gynecology.

È considerato il fondatore della Ginecologia.

Está considerado como el fundador de la Ginecología.



Fig.	fest <i>rigide</i> rigide <i>rigidas</i>	biegsam <i>malleable</i> malleabili <i>malleables</i>	mm
00	GK 920.05	GK 921.05	5
0	GK 920.06	GK 921.06	6
1	GK 920.07	GK 921.07	7
2	GK 920.08	GK 921.08	8
3	GK 920.09	GK 921.09	9
4	GK 920.11	GK 921.11	11
5	GK 920.12	GK 921.12	12
6	GK 920.14	GK 921.14	14
7	GK 920.15	GK 921.15	15
8	GK 920.16	GK 921.16	16
9	GK 920.19	GK 921.19	19
10	GK 920.20	GK 921.20	20
11	GK 920.21	GK 921.21	21
12	GK 920.23	GK 921.23	23

scharf, *sharp*, taglienti, *cortantes*

RÉCAMIER
GK 920.05 - GK 920.23
GK 921.05 - GK 921.23
 310mm /12¹/₄"



Fig.	fest <i>rigide</i> rigide <i>rigidas</i>	biegsam <i>malleable</i> malleabili <i>malleables</i>	mm
00	GK 926.05	GK 927.05	5
0	GK 926.06	GK 927.06	6
1	GK 926.07	GK 927.07	7
2	GK 926.08	GK 927.08	8
3	GK 926.09	GK 927.09	9
4	GK 926.11	GK 927.11	11
5	GK 926.12	GK 927.12	12
6	GK 926.14	GK 927.14	14
7	GK 926.15	GK 927.15	15
8	GK 926.16	GK 927.16	16
9	GK 926.19	GK 927.19	19
10	GK 926.20	GK 927.20	20
11	GK 926.21	GK 927.21	21
12	GK 926.23	GK 927.23	23

stumpf, *blunt*, smusse, *romas*

SIMS
GK 926.05 - GK 926.23
GK 927.05 - GK 927.23
 310mm /12¹/₄"

Uterus- und Absaugkürretten, Uterus - Sonden, -Depressoren
Uterine and Aspirating Curettes, Uterine Sound and Depressors
Curette uterine e d'aspirazione, Isterometri e Depressori uterini
Curetas uterinas y de aspiración, Histerómetros, Depresores uterinos



stumpf,
blunt,
smussa,
roma



scharf,
sharp,
tagliente,
cortante

BLAKE
GK 964.27
 270mm / 10½"



GK 989.03 - GK 989.14
 280mm / 11"

Schlauch- Verbindungsstück
 Hose connecting piece
 Pezzo di connessione per tubi
 Pieza conexión para tubos



GK 989.50

- GK 989.03 // Ø 3mm
- GK 989.04 // Ø 4mm
- GK 989.06 // Ø 6mm
- GK 989.08 // Ø 8mm
- GK 989.10 // Ø 10mm
- GK 989.12 // Ø 12mm
- GK 989.14 // Ø 14mm



SIMS
GQ 583.32
GQ 584.32
 320mm / 12½"



MARTIN (SIMPSON)
GQ 585.32
GQ 586.32
 320mm / 12½"



COLLIN
GQ 591.28
 280mm / 11"



VALLEIX
GQ 593.25
 250mm / 10"



BRAUN
GQ 595.26
 260mm / 10¼"

Scheidenspekula
 Vaginal Specula
 Specoli vaginali
 Espéculos vaginales

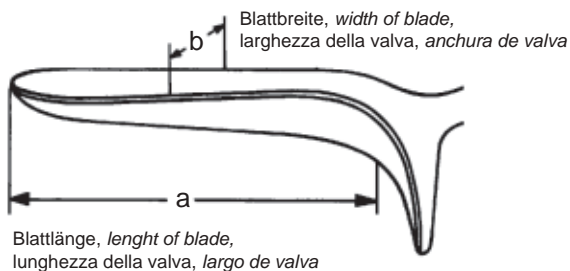

a b
GU 112.01 // 75mm 17mm

für Jungfrauen, *for virgins*,
 per vergini, *para virgenes*

CUSCO



a b
GU 116.01 // 75mm 32mm
GU 116.02 // 85mm 35mm
GU 116.03 // 100mm 37mm

CUSCO

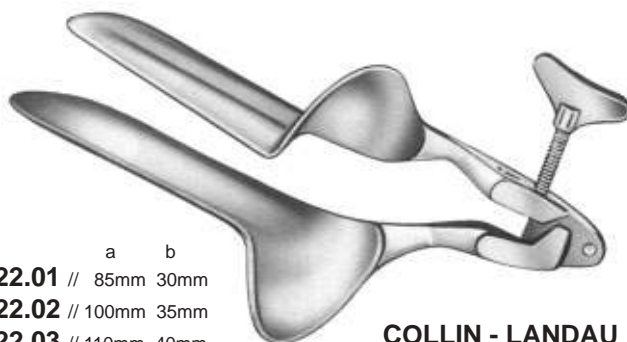

a b
GU 122.01 // 85mm 30mm
GU 122.02 // 100mm 35mm
GU 122.03 // 110mm 40mm

COLLIN - LANDAU



a b
GU 110.01 // 75mm 32mm
GU 110.02 // 85mm 35mm
GU 110.03 // 100mm 37mm

CUSCO



a b
GU 114.01 // 90mm 23-25mm
GU 114.02 // 100mm 25-27mm
GU 114.03 // 110mm 27-30mm

Schweizer Modell, *Swiss pattern*,
 Modello svizzero, *Modelo suizo*

CUSCO

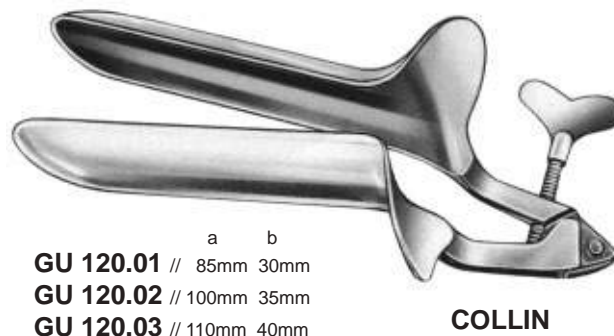

a b
GU 120.01 // 85mm 30mm
GU 120.02 // 100mm 35mm
GU 120.03 // 110mm 40mm

COLLIN

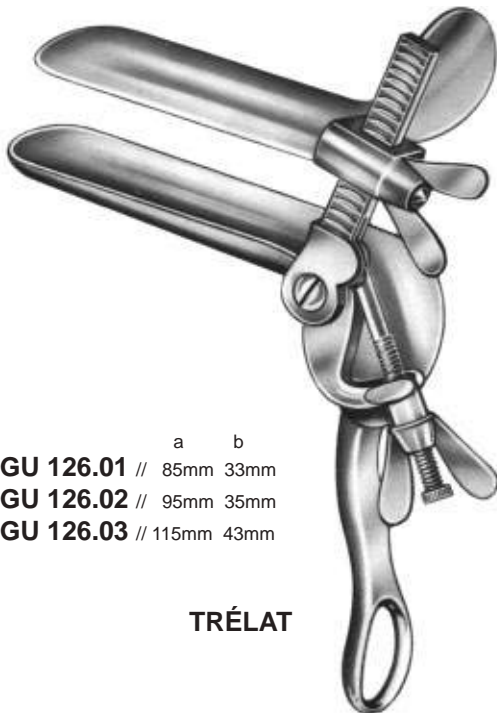

	a	b
GU 126.01	// 85mm	33mm
GU 126.02	// 95mm	35mm
GU 126.03	// 115mm	43mm

TRÉLAT

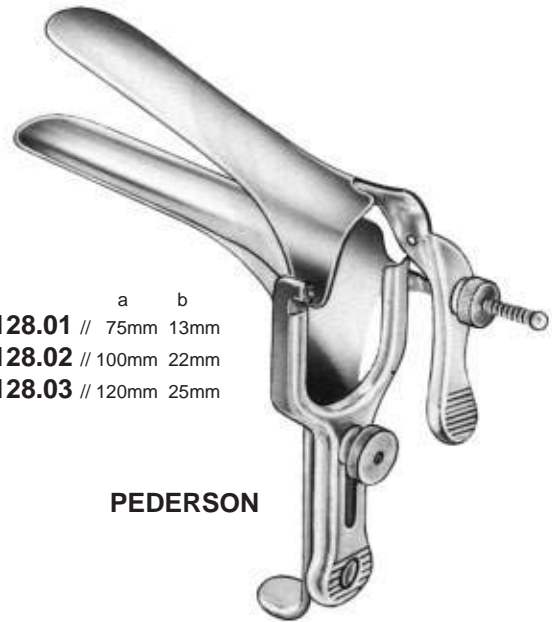

	a	b
GU 128.01	// 75mm	13mm
GU 128.02	// 100mm	22mm
GU 128.03	// 120mm	25mm

PEDERSON

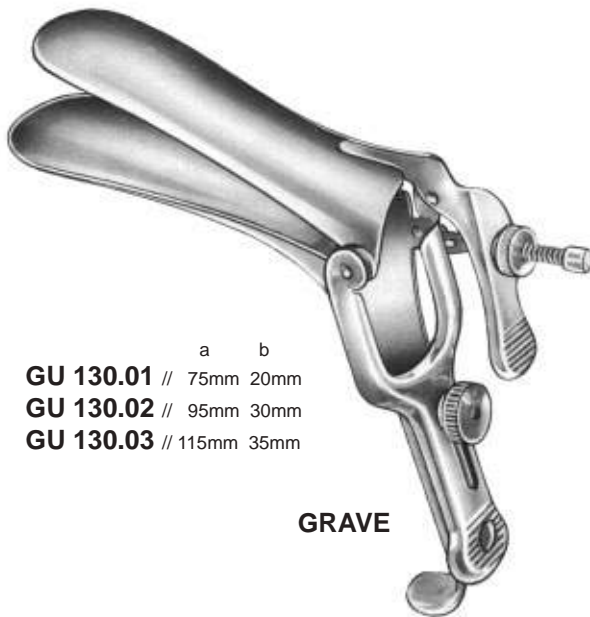

	a	b
GU 130.01	// 75mm	20mm
GU 130.02	// 95mm	30mm
GU 130.03	// 115mm	35mm

GRAVE

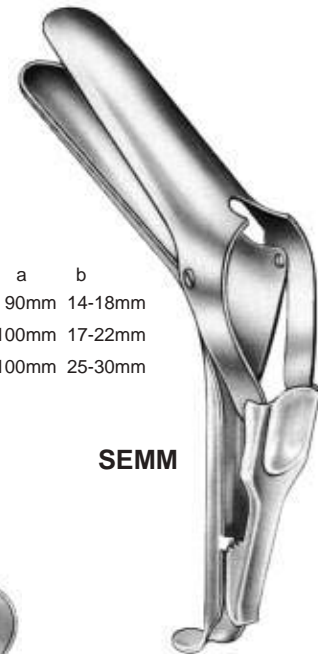

	a	b
GU 132.01	// 90mm	14-18mm
GU 132.02	// 100mm	17-22mm
GU 132.03	// 100mm	25-30mm

SEMM

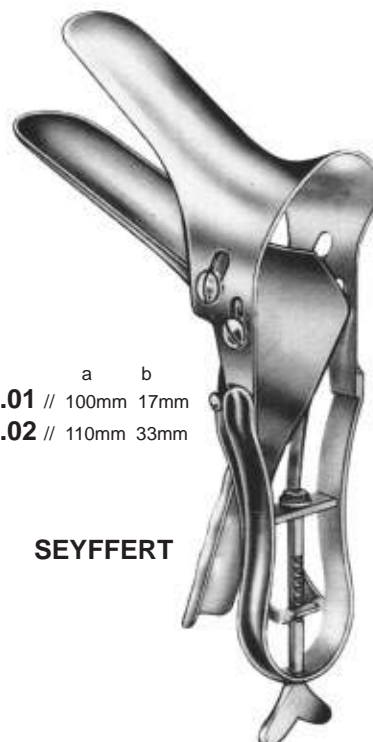

	a	b
GU 134.01	// 100mm	17mm
GU 134.02	// 110mm	33mm

SEYFFERT

Scheidenspekula und -halter
Vaginal Specula and Retractors
Specoli e valve vaginali
Espéculos y valvas vaginales

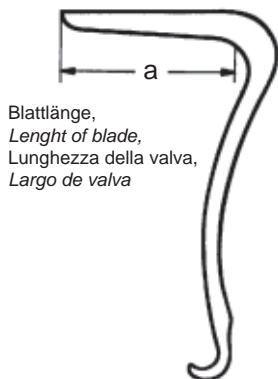

Blattlänge,
Length of blade,
 Lunghezza della valva,
 Largo de valva



Blattbreite,
Width of blade,
 Larghezza della valva,
 Anchura de valva



SIMS

	a	b
GU 160.01	// 60mm	25+30mm
GU 160.02	// 70mm	30+35mm
GU 160.03	// 80mm	35+40mm



JACKSON

	a	b
GU 164.01	// 75mm	35mm
GU 164.02	// 90mm	35mm
GU 164.03	// 100mm	35mm
GU 166.01	// 75mm	40mm
GU 166.02	// 90mm	40mm
GU 166.03	// 100mm	40mm



Spekula, *Specula,*
 Specolo, *Espéculo* ✱

KRISTELLER

GU 182.01 - GU 182.03
GU 183.01 - GU 183.03
GU 185.01 - GU 185.03

☹ Halter, *Retractor,*
 Valva, *Valva*

Spekula, *Specula,*
 Specoli, *Espéculos*

	a	b
GU 182.01	// 70mm	27mm
GU 182.02	// 75mm	30mm
GU 182.03	// 90mm	36mm

Halter, *Retractors,*
 Valve, *Valvas*

	a	b
GU 183.01	// 75mm	23mm
GU 183.02	// 85mm	26mm
GU 183.03	// 95mm	32mm

Satz aus je 1 Spekula und Halter,
Set of 1 specula and 1 retractor,
 Serie da 1 specolo e 1 valva,
 Juego de 1 espéculo y 1 valva

GU 185.01
GU 185.02
GU 185.03

mit konisch verlaufenden Blättern, für Jungfrauen,
with conically shaped blades, for virgins,
 con valve coniche, per vergine,
 con valvas de forma cónica, para virgenes

Spekula, Specula,
 Specolo, Espéculo ✂

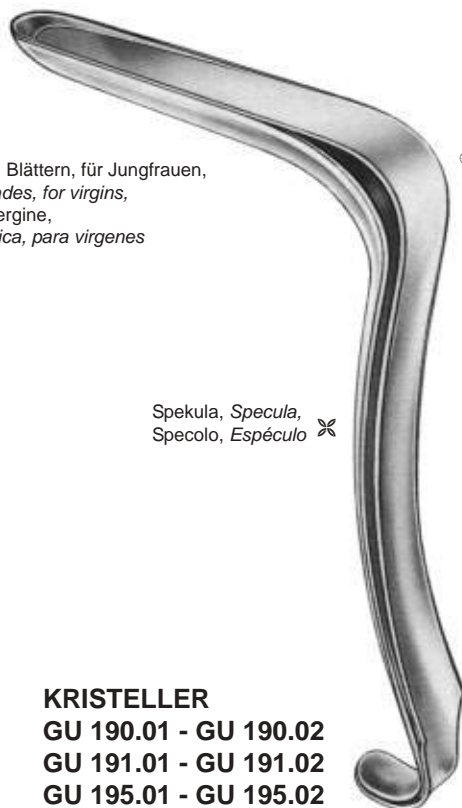

① Halter, Retractor,
 Valva, Valva

Spekula, Specula,
 Specoli, Espéculos

	a	b
GU 190.01	// 110mm	18mm
GU 190.02	// 110mm	21mm

Halter, Retractors,
 Valve, Valvas

	a	b
GU 191.01	// 115mm	14mm
GU 191.02	// 115mm	17mm

Satz aus je 1 Spekula und Halter,
Set of 1 specula and 1 retractor,
 Serie da 1 specolo e 1 valva,
 Juego de 1 espéculo y 1 valva

GU 195.01
GU 195.02

KRISTELLER
GU 190.01 - GU 190.02
GU 191.01 - GU 191.02
GU 195.01 - GU 195.02



mit flachen Spekula,
with flat hollow specula,
 con specoli piatti,
 con espéculos planos

Spekula, Specula,
 Specolo, Espéculo ✂



① Halter, Retractor,
 Valva, Valva

Spekula, Specula,
 Specoli, Espéculos

	a	b
GU 196.01	// 110mm	27mm
GU 196.02	// 110mm	30mm
GU 196.03	// 110mm	36mm

Halter, Retractors,
 Valve, Valvas

	a	b
GU 197.01	// 115mm	23mm
GU 197.02	// 115mm	26mm
GU 197.03	// 115mm	32mm

Satz aus je 1 Spekula und Halter,
Set of 1 specula and 1 retractor,
 Serie da 1 specolo e 1 valva,
 Juego de 1 espéculo y 1 valva

GU 199.01
GU 199.02
GU 199.03

KRISTELLER
GU 196.01 - GU 196.03
GU 197.01 - GU 197.03
GU 199.01 - GU 199.03

Scheidenspekula und -halter
Vaginal Specula and Retractors
Specoli e valve vaginali
Espéculos y valvas vaginales



mit tiefen Spekula,
with deep hollow specula,
 con specoli profondi,
 con espéculos profundos

Spekula, Specula,
 Specolo, Espéculo ✕

① Halter, Retractor,
 Valva, Valva

Spekula, Specula,
 Specoli, Espéculos

	a	b
GU 202.01	// 110mm	27mm
GU 202.02	// 110mm	30mm
GU 202.03	// 110mm	36mm

Halter, Retractors,
 Valve, Valvas

	a	b
GU 203.01	// 115mm	23mm
GU 203.02	// 115mm	26mm
GU 203.03	// 115mm	32mm

Satz aus je 1 Spekula und Halter,
Set of 1 specula and 1 retractor,
 Serie da 1 specolo e 1 valva,
Juego de 1 espéculo y 1 valva

KRISTELLER
GU 202.01 - GU 202.03
GU 203.01 - GU 203.03
GU 205.01 - GU 205.03

GU 205.01
GU 205.02
GU 205.03

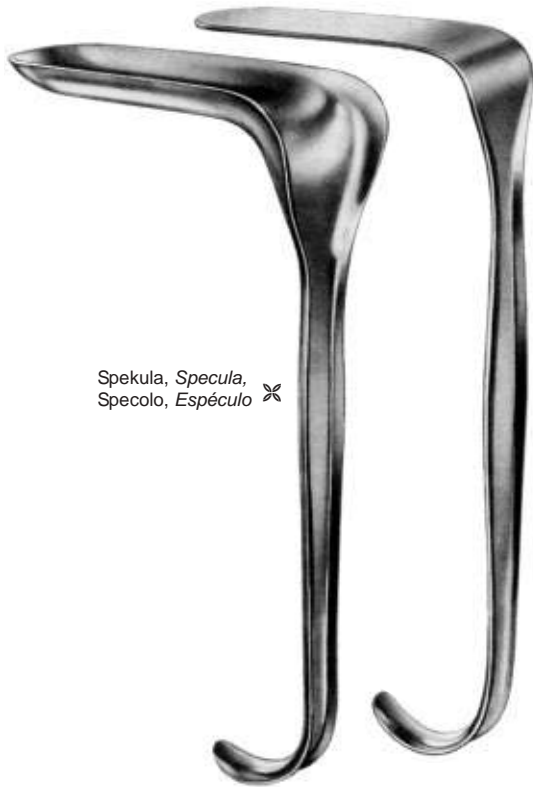

Spekula, Specula,
 Specolo, Espéculo ✕

① Halter, Retractor,
 Valva, Valva

Spekula, Specula,
 Specoli, Espéculos

	a	b
GU 232.01	// 70mm	40mm
GU 232.02	// 90mm	40mm

Halter, Retractors,
 Valve, Valvas

	a	b
GU 233.01	// 70mm	33mm
GU 233.02	// 90mm	33mm

Satz aus je 1 Spekula und Halter,
Set of 1 specula and 1 retractor,
 Serie da 1 specolo e 1 valva,
Juego de 1 espéculo y 1 valva

GU 235.01
GU 235.02

KALLMORGEN
GU 232.01 - GU 232.02
GU 233.01 - GU 233.02
GU 235.01 - GU 235.01

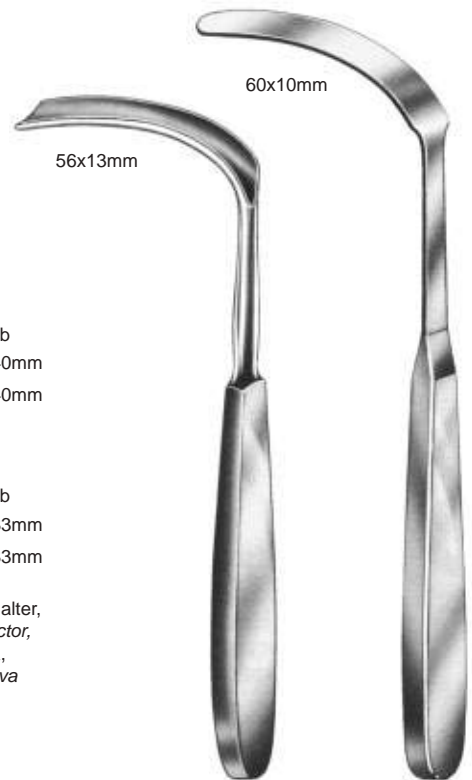

56x13mm

60x10mm

BRAUN
GU 236.01
 180mm / 7"

BRAUN
GU 237.01
 180mm / 7"



Spekula, *Specula*,
 Specolo, *Espéculo* ✂

Ⓢ Halter, *Retractor*,
 Valva, *Valva*

Spekula, *Specula*,
 Specoli, *Espéculos*

	a	b
GU 242.01	// 95mm	16/26mm
GU 242.02	// 95mm	16/30mm

Halter, *Retractors*,
 Valve, *Valvas*

	a	b
GU 243.01	// 100mm	11/20mm
GU 243.02	// 100mm	14/26mm

Satz aus je 1 Spekula und Halter,
Set of 1 specula and 1 retractor,
 Serie da 1 specolo e 1 valva,
Juego de 1 espéculo y 1 valva

GU 245.01
GU 245.02

MATHIEU
GU 242.01 - GU 242.02
GU 243.01 - GU 243.02
GU 245.01 - GU 245.01



leichtthohl,
slightly - concave,
 leggermente concavo,
ligeramente concavos

	a	b
GU 249.01	// 60mm	35mm
GU 249.02	// 90mm	35mm
GU 249.03	// 120mm	35mm
GU 249.04	// 140mm	35mm
GU 249.05	// 160mm	35mm
GU 249.06	// 180mm	35mm
GU 250.01	// 60mm	45mm
GU 250.02	// 90mm	45mm
GU 250.03	// 120mm	45mm
GU 250.04	// 140mm	45mm
GU 250.05	// 160mm	45mm
GU 250.06	// 180mm	45mm
GU 251.01	// 60mm	60mm
GU 251.02	// 90mm	60mm
GU 251.03	// 120mm	60mm
GU 251.04	// 140mm	60mm
GU 251.05	// 160mm	60mm
GU 251.06	// 180mm	60mm

DOYEN
GU 249.01 - GU 251.06
 240mm / 9½"

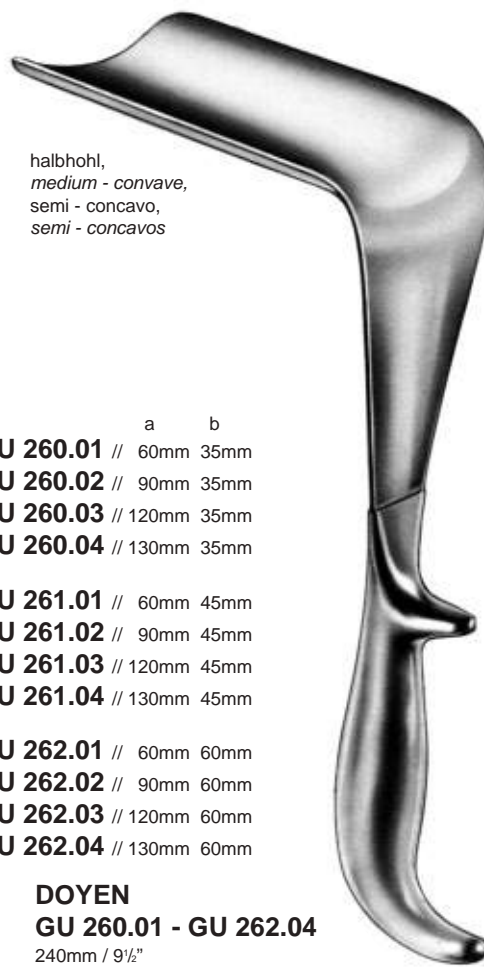

halbthohl,
medium - concave,
 semi - concavo,
semi - concavos

	a	b
GU 260.01	// 60mm	35mm
GU 260.02	// 90mm	35mm
GU 260.03	// 120mm	35mm
GU 260.04	// 130mm	35mm
GU 261.01	// 60mm	45mm
GU 261.02	// 90mm	45mm
GU 261.03	// 120mm	45mm
GU 261.04	// 130mm	45mm
GU 262.01	// 60mm	60mm
GU 262.02	// 90mm	60mm
GU 262.03	// 120mm	60mm
GU 262.04	// 130mm	60mm

DOYEN
GU 260.01 - GU 262.04
 240mm / 9½"

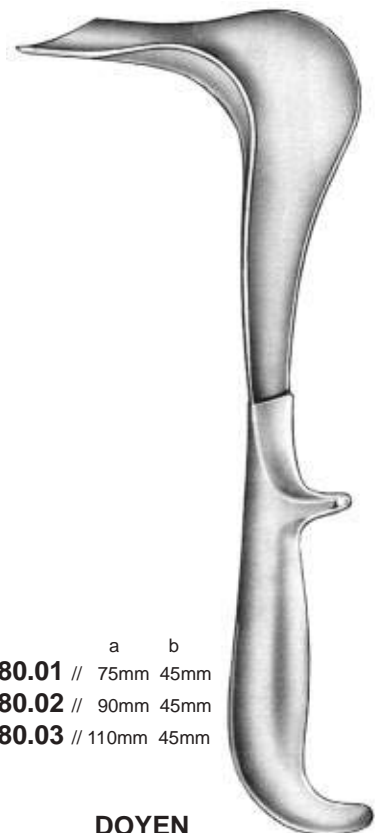

a b
GU 280.01 // 75mm 45mm
GU 280.02 // 90mm 45mm
GU 280.03 // 110mm 45mm

DOYEN
GU 280.01 - GU 280.03



GU 302.14
 Griff, Handle,
 Manico, Mango

SCHERBAK
GU 302.00

komplett, complete,
 completo, completo



GU 302.01
 80x30mm



GU 302.04
 55x40/60mm



GU 302.02
 85x35mm



GU 302.05
 70x45/70mm

GU 302.10

Gewicht, leicht, 400g
 Weight, light, 400grs,
 Peso, leggero, 400gr,
 Peso, ligero, 400grs

GU 302.12

Gewicht, schwer, 800g
 Weight, heavy, 800grs,
 Peso, pesante, 800gr,
 Peso, pesado, 800grs



GU 302.03
 90x40mm



80x38mm

mit abnehmbarem Gewicht,
 with removable weight,
 con peso smontabile,
 con peso desmontable

AUWARD
GU 310.22



80x42mm

WEISSBARTH
GU 314.24

komplett mit abnehmbarem Auffangsieb,
 complete with removable strainer with perforated bottom,
 completo con crivello smontabile,
 completo con tamiz desmontable



BREISKY

a b
GU 323.20 // 100 20mm
GU 323.25 // 100 25mm
GU 323.30 // 100 30mm
GU 323.35 // 100 35mm
GU 323.40 // 100 40mm
 290mm / 11¹/₄"



BREISKY

a b
GU 324.20 // 130 20mm
GU 324.25 // 130 25mm
GU 324.30 // 130 30mm
GU 324.35 // 130 35mm
GU 324.40 // 130 40mm
 320mm / 12¹/₂"



BREISKY

a b
GU 325.20 // 160 20mm
GU 325.25 // 160 25mm
GU 325.30 // 160 30mm
GU 325.35 // 160 35mm
GU 325.40 // 160 40mm
 350mm / 13³/₄"



LANDAU

a b
GU 326.01 // 100 28mm
GU 326.02 // 110 38mm
 300mm / 12"

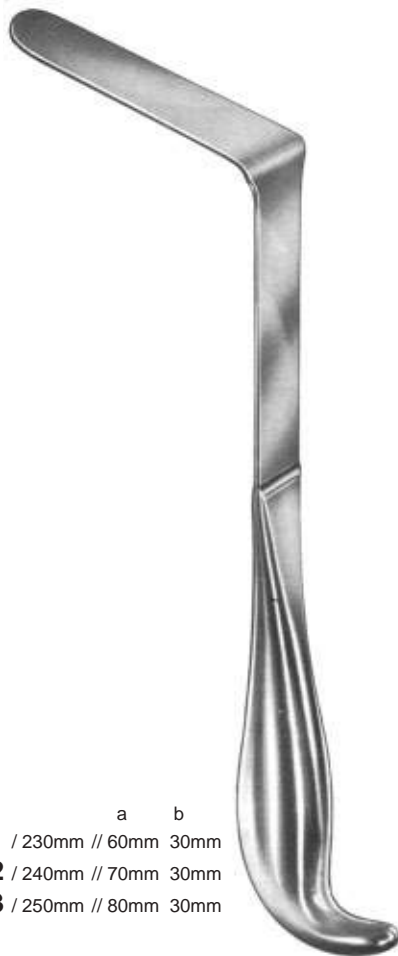

DOYEN

- | | | |
|------------------|-----------------|------|
| | a | b |
| GU 342.01 | / 230mm // 60mm | 30mm |
| GU 342.02 | / 240mm // 70mm | 30mm |
| GU 342.03 | / 250mm // 80mm | 30mm |

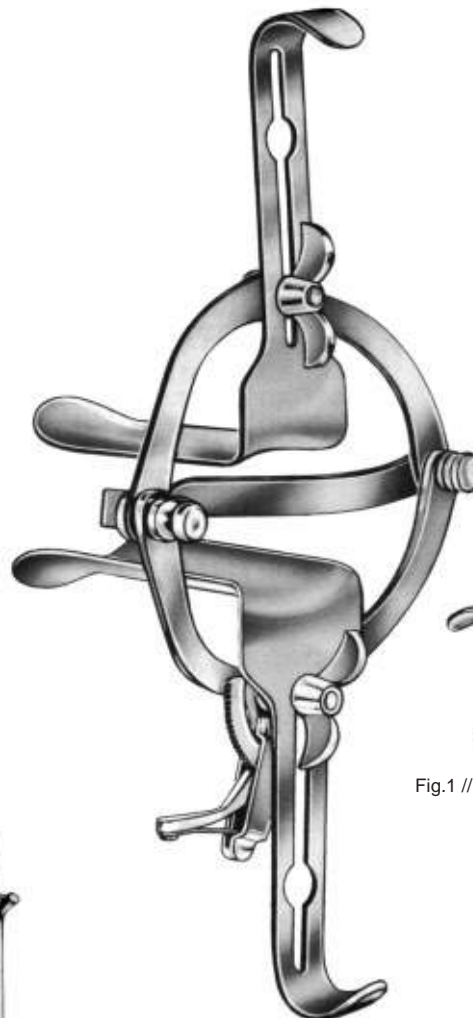
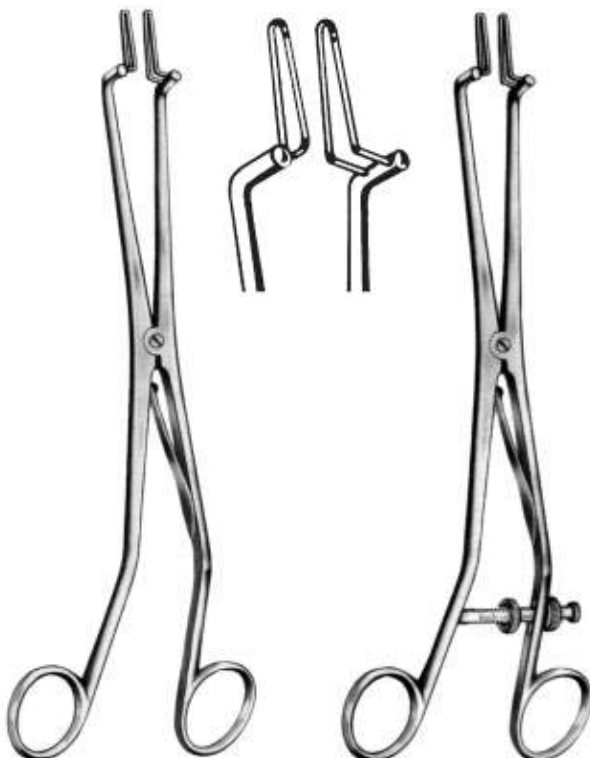

Fig.3 // 90x45mm

Fig.2 // 90x37mm

Fig.1 // 45x17mm



KOGAN
GU 381.24
 240mm / 9½"

KOGAN
GU 383.24
 240mm / 9½"
 Mit Skalensperre und Fixierschraube,
 With scale-ratchet and fixing screw,
 Cremagliera con scala e vite di fissaggio,
 Cremallera graduada y tornillos fijadores

O'SULLIVAN - O'CONNOR
GU 351.00

Scheidenspekula, für Untersuchungen und Operationen, selbsthaltend, mit verstellbarem Rahmen, Loktite-Sperre, 2 beweglichen seitlichen Blättern und 3 austauschbaren Blättern Fig.1-3.

Vaginal specula, for examination and operative work, self-retaining, with adjustable frame, Loktite ratchet, 2 mobile lateral blades and 3 interchangeable blades fig.1-3.

Specolo vaginale per esami e operazioni, automatico, con telaio regolabile, cremagliera Loktite, 2 valve laterali mobili e 3 valve intercambiabili fig.1-3.

Espéculo vaginal, de retención automática, para exámenes y operaciones, con cuadro movible, cremallera Loktite, 2 separadores móviles al lado y 3 separadores intercambiables fig.1-3.



HEGAR
GV 400.01 - GV 400.30
GV 401.01 - GV 401.19

	Ø		Ø
GV 400.01	// 1,0mm	GV 401.01	// 1,5mm
GV 400.02	// 2,0mm	GV 401.02	// 2,5mm
GV 400.03	// 3,0mm	GV 401.03	// 3,5mm
GV 400.04	// 4,0mm	GV 401.04	// 4,5mm
GV 400.05	// 5,0mm	GV 401.05	// 5,5mm
GV 400.06	// 6,0mm	GV 401.06	// 6,5mm
GV 400.07	// 7,0mm	GV 401.07	// 7,5mm
GV 400.08	// 8,0mm	GV 401.08	// 8,5mm
GV 400.09	// 9,0mm	GV 401.09	// 9,5mm
GV 400.10	// 10,0mm	GV 401.10	// 10,5mm
GV 400.11	// 11,0mm	GV 401.11	// 11,5mm
GV 400.12	// 12,0mm	GV 401.12	// 12,5mm
GV 400.13	// 13,0mm	GV 401.13	// 13,5mm
GV 400.14	// 14,0mm	GV 401.14	// 14,5mm
GV 400.15	// 15,0mm	GV 401.15	// 15,5mm
GV 400.16	// 16,0mm	GV 401.16	// 16,5mm
GV 400.17	// 17,0mm	GV 401.17	// 17,5mm
GV 400.18	// 18,0mm	GV 401.18	// 18,5mm
GV 400.19	// 19,0mm	GV 401.19	// 19,5mm
GV 400.20	// 20,0mm		
GV 400.21	// 21,0mm		
GV 400.22	// 22,0mm		
GV 400.23	// 23,0mm		
GV 400.24	// 24,0mm		
GV 400.25	// 25,0mm		
GV 400.26	// 26,0mm		
GV 400.27	// 27,0mm		
GV 400.28	// 28,0mm		
GV 400.29	// 29,0mm		
GV 400.30	// 30,0mm		



GV 400.84 - GV 400.94

Satz in Metalletui,
Set in metal case,
Serie in scatola di metallo
Juego en estuche de metal

GV 400.84

Satz zu 14 Dilatatoren Ø 4,0 - 17mm, in Metalletui.

Set of 14 dilators Ø 4,0 - 17mm, in metal case.

Serie di 14 dilatatori di Ø 4,0 - 17mm, in scatola di metallo.

Juego de 14 dilatadores Ø 4,0 - 17mm, en estuche de metal.

GV 400.94

Satz zu 26 Dilatatoren Ø 1,0 - 26mm, in Metalletui.

Set of 26 dilators Ø 1,0 - 26mm, in metal case.

Serie di 26 dilatatori di Ø 1,0 - 26mm, in scatola di metallo.

Juego de 26 dilatadores Ø 1,0 - 26mm, en estuche de metal.



	Ø
GV 430.02	// 1,0/2,0mm
GV 430.04	// 3,0/4,0mm
GV 430.06	// 5,0/6,0mm
GV 430.08	// 7,0/8,0mm
GV 430.10	// 9,0/10,0mm
GV 430.12	// 11,0/12,0mm
GV 430.14	// 13,0/14,0mm
GV 430.16	// 15,0/16,0mm
GV 430.18	// 17,0/18,0mm
GV 430.20	// 19,0/20,0mm
GV 430.22	// 21,0/22,0mm
GV 430.24	// 23,0/24,0mm
GV 430.26	// 25,0/26,0mm

HEGAR
GV 430.02 - GV 430.26

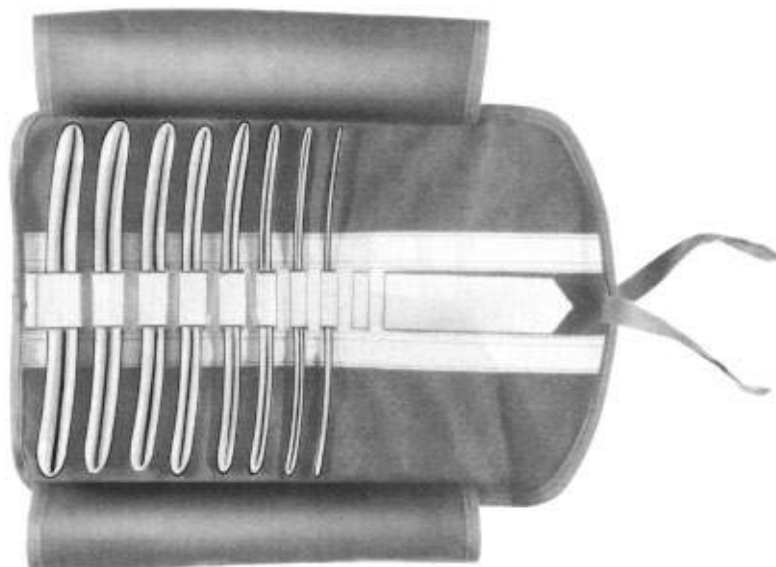

GV 430.82

Satz zu 8 Dilatatoren Ø 3,0/4,0 - 17/18mm, in auskochbarer Stoff-Rolltasche.
Set of 8 dilators Ø 3,0/4,0 - 17/18mm, in boilable canvas roll.
 Serie di 8 dilatatori di Ø 3,0/4,0 - 17/18mm, in busta di tela sterilizzabile in acqua bollente.
Juego de 8 dilatadores Ø 3,0/4,0 - 17/18mm, en bolsa de tela esterilizabile por ebullición.



GV 430.84 - GV 430.94

Satz in Metalletui,
Set in metal case,
 Serie in scatola di metallo
Juego en estuche de metal

GV 430.84

Satz zu 8 Dilatatoren Ø 3,0/4,0 - 17/18mm, in Metalletui.
Set of 8 dilators Ø 3,0/4,0 - 17/18mm, in metal case.
 Serie di 8 dilatatori di Ø 3,0/4,0 - 17/18mm, in scatola di metallo.
Juego de 8 dilatadores Ø 3,0/4,0 - 17/18mm, en estuche de metal.

GV 430.94

Satz zu 13 Dilatatoren Ø 1,0/2,0 - 25/26mm, in Metalletui.
Set of 13 dilators Ø 1,0/2,0 - 25/26mm, in metal case.
 Serie di 13 dilatatori di Ø 1,0/2,0 - 25/26mm, in scatola di metallo.
Juego de 13 dilatadores Ø 1,0/2,0 - 25/26mm, en estuche de metal.



HANK
GV 460.10 - GV 460.20

	Ø	Fig.
GV 460.10	// 4,5/5,0mm	9/10
GV 460.12	// 5,5/6,0mm	11/12
GV 460.14	// 6,5/7,0mm	13/14
GV 460.16	// 7,5/8,0mm	15/16
GV 460.18	// 8,5/9,0mm	17/18
GV 460.20	// 9,5/10,0mm	19/20



HANK
GV 460.82

Satz zu 6 Dilatatore Ø 4,5/5,0 - 9,5/10mm, in auskochbarer Stoff-Rolltasche.

Set of 6 dilators Ø 4,5/5,0 - 9,5/10mm, in boilable canvas roll.

Serie di 6 dilatatori di Ø 4,5/5,0 - 9,5/10mm, in busta di tela sterilizzabile in acqua bollente.

Juego de 6 dilatadores Ø 4,5/5,0 - 9,5/10mm, en bolsa de tela esterilizabile por ebullición.

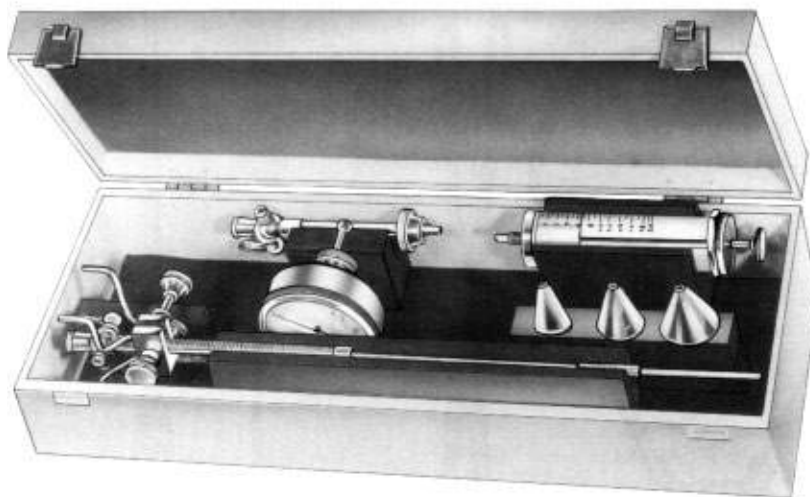

SCHULTZE
GV 995.00 - GV 995.01

GV 995.00

Instrumentarium für Sterilitätsdiagnose und Salpingographie nach Prof. Schultze, zur Röntgen-Kontrast-Füllung von Uterus und Tuben, und zur Durchblasung von Cervix, Uterus und Tuben,

bestehend aus:

- Hauptstück mit einzeln verstellbaren Zangenhaltern,
 - Verbindungsstück,
 - Druckmanometer mit Leuchtskala,
 - Luer-Lock Spritze 10ccm,
 - 3 auswechselbaren Uterusverschlußkegeln in 3 verschiedenen Größen
- komplett in Holzetui.

Salpingograph for diagnosis and treatment of sterility, for injections of Lipiodol into the uterus and the Fallopian Tubes, for intra-uterine insufflation and for diagnosis by X-rays, consisting of:

- Main attachment with adjustable forceps holders,*
 - Connecting piece,*
 - Manometer with luminous dial,*
 - Luer-Lock syringe of 10ccm,*
 - 3 interchangeable occlusive nozzles of metal, of 3 different sizes,*
- complete in wooden case.*

Salpingografo per la diagnostica ed il trattamento della sterilità, per iniezioni di Lipiodo nell'utero, per insufflazione intrauterina e per la diagnostica radiografica, composto da:

- Pezzo principale con portapinzette regolabili,
 - Raccordo,
 - Manometro con scala luminosa,
 - Siringa Luer-Lock di 10cc.,
 - 3 coni uterini intercambiabili di metallo, di tre differenti grandezze,
- completo in scatola di legno.

Salpingógrafo completo para el diagnóstico y tratamiento de la esterilidad, para inyecciones de Lipiodol en el útero y en las trompas de Falopio, para la insuflación intra-uterina y para el diagnóstico radiográfico, compuesto de:

- Pieza principal con porta-pinzas ajustables,*
 - Pieza de conexión,*
 - Manómetro con escala luminosa,*
 - Jeringa Luer-Lock de 10cc.,*
 - 3 conos uterinos intercambiables de metal, de diferentes tamaños,*
- en estuche de madera.*

GV 995.01

dito, jedoch ohne Manometer,
ditto, but without manometer,
idem, pero senza manometro,
idem, pero sin manómetro.





GEBURTSHILFE
OBSTETRICS
OSTETRICIA
OBSTETRICIA



NAEGELE
GC 402.25
250mm / 10"

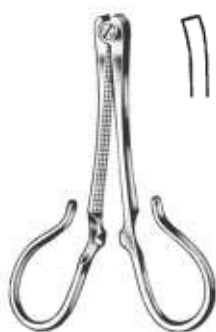

KANE
GC 461.08
80mm / 3 1/4"



COLLIN
GC 465.09
90mm / 3 1/2"



NAEGELE
GF 141.36 // 360mm / 14"
GF 141.40 // 400mm / 15 3/4"



SIMPSON
GF 145.30
300mm / 12"



SIMPSON - BRAUN
GF 149.36
360mm / 14"



SIMPSON - LUIKART
GF 155.36
360mm / 14"



ELLIOT
GF 177.32 // 320mm / 12 1/2"
GF 177.38 // 380mm / 15"



KIELLAND
GF 195.41
410mm / 16"



GREEN - ARMYTAGE
GF 300.21
 210mm / 8 1/4"



SAENGER
GF 328.27 - GF 329.27
 270mm / 10 1/2"

GF 328.27

GF 329.27

Abortuszangen, *Ovum Forceps*,
 Pinze per l'aborto, *Pinzas para aborto*



Abortuszangen,
Ovum Forceps,
 Pinze per l'aborto,
Pinzas para aborto

WINTER
GF 344.01 - GF 345.03
 280mm / 11"



GF 344.01



GF 344.02



GF 344.03

gerade, *straight*, *rette*, *rectas*



GF 345.01



GF 345.02



GF 345.03

gebogen, *curved*, *curve*, *curvas*

Geburtslöffel, Abortusküretten und -löffel
Elevating Spoon, Ovum Curettes, Abortion Scoops
 Cucchiaino ostetrico, Curette per aborto
 Separador obstétrico, Curetas y Cucharillas para aborto



SELLHEIM
GK 309.28
 280mm / 11"



Rückseite gezahnt,
Toothed back,
 Dorso dentellato,
 Con dorso dentado

CUZZI
GK 382.01 - GK 382.03
 300mm / 12"

stumpf, blunt, smusse, romas



14mm
 GK 382.01

18mm
 GK 382.02

21mm
 GK 382.03



PESTALOZZA
GK 386.30
 300mm / 12"



WALLICH
GK 392.02
 420mm / 16½"

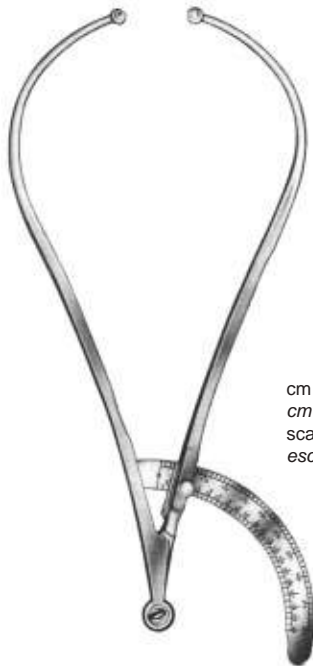

cm / Zoll Skala,
cm / inch scale,
scala in cm / polici,
escala en cm / pulg.

MARTIN
GV 103.34
340mm / 13½"



cm Skala,
cm scale,
scala in cm,
escala en cm.

COLLIN
GV 107.35
350mm / 13¾"



cm / Zoll Skala,
cm / inch scale,
scala in cm / polici,
escala en cm / pulg.

BREISKY
GV 115.33
330mm / 13"





KNOCHENCHIRURGIE
BONE SURGERY
CHIRURGIA OSSEA
CIRUGÌA ÒSSEA

Meniskusmesser
Meniscotomy Knives
Meniscotomi
Meniscotomos



BIRCHER
KA 611.19 - KA 613.19
 190mm / 7½"



SMILLIE
KA 630.17
 170mm / 6¾"



SMILLIE
KA 631.17
 170mm / 6¾"



SMILLIE
KA 633.17
 170mm / 6¾"



KA 641.18
 180mm / 7"



KA 643.22



KA 645.22

NEFF
KA 643.22 - KA 645.22
 220mm / 8¾"



SALENIUS
KA 650.22
 220mm / 8¾"



SALENIUS
KA 651.22
 220mm / 8¾"



STEINMANN
KC 674.16
 160mm / 6½"



KC 676.15
 150mm / 6"

KC 676.19
 190mm / 7½"

KC 676.24
 240mm / 9½"

BRAND
KC 676.15 - KC 676.24



KC 678.00 - KC 678.01
 200mm / 8"

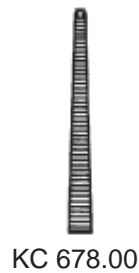

CAROLL
KC 679.11
 110mm / 4½"

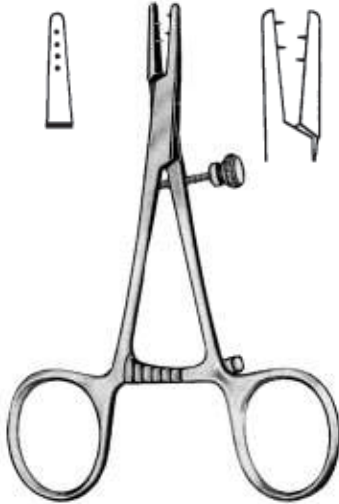

KC 680.13
130mm / 5"

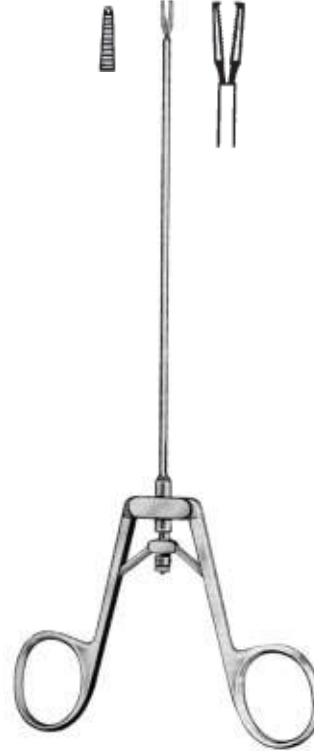

KLEINERT - KUTZ
KC 681.20
200mm / 8"

Sehnenflechtklemmen, *Tendon Interlacing Forceps*,
Pinze per intrecciare tendini, *Pinzas para interlazar tendones*

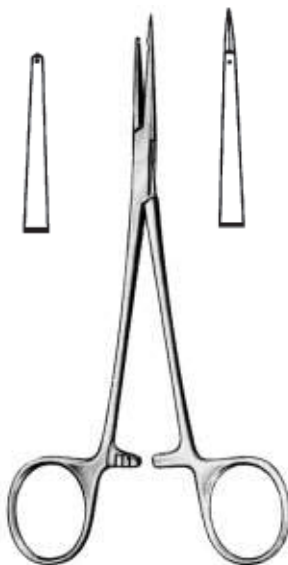

KC 682.15
150mm / 6"



KC 683.15
150mm / 6"



KD 484.17



KD 485.17



KD 486.17



KD 487.17



ADSON
KD 484.17 - KD 487.17
170mm / 6 $\frac{3}{4}$ "



8mm



KD 495.20

10mm



KD 497.20

LANGENBECK
KD 495.20 - KD 497.20
200mm / 8"



5mm



KD 499.01
170mm / 6 $\frac{3}{4}$ "

7mm



KD 499.02
170mm / 6 $\frac{3}{4}$ "

8mm



KD 499.03
200mm / 8"

10mm



KD 499.04
200mm / 8"

LANGENBECK
KD 499.01 - KD 499.04

Titan, Titanium
Titanio, Titanio



Periost - Elevatorium
Periosteal Elevator
Elevatore per il periostio
Elevador para periostio

KD 506.17
170mm / 6³/₄"



Weichteil - Dissektor
Soft tissue dissector
Dissettore per tessuti molli
Disector para tejidos blandos

KD 508.17
170mm / 6³/₄"



WILLIGER
KD 510.17
170mm / 6³/₄"



WILLIGER
KD 513.16
160mm / 6¹/₂"



extrem leicht,
extremely lightweight,
estremamente leggero,
extremamente ligero

KD 514.17
170mm / 6³/₄"



Mikro - Elevatorium,
Micro Elevator,
Micro elevatore,
Elevador - Micro

KD 518.16
160mm / 6¹/₂"



KEY
KD 519.06 - KD 519.25
190mm / 7¹/₂"



KD 519.06 // 6mm
KD 519.12 // 12mm
KD 519.19 // 19mm
KD 519.25 // 25mm

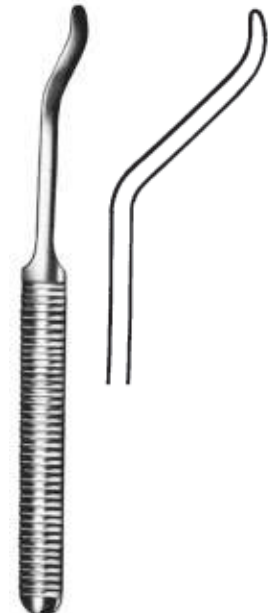

KD 523.16
160mm / 6¹/₂"



ALDERDYCE
KD 525.21
 210mm / 8 1/4"



MC DONALD
KD 527.19
 190mm / 7 1/2"



WATSON - CHEYNE
KD 529.13 // 130mm / 5"
KD 529.18 // 180mm / 7"

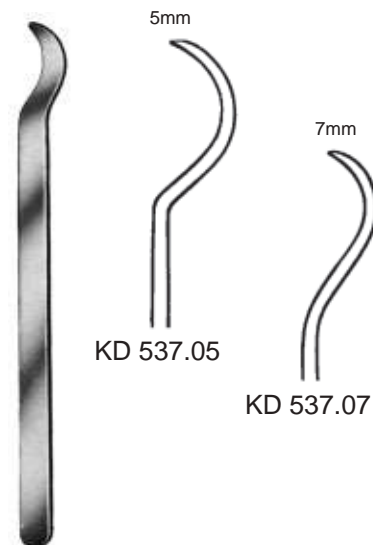

KD 537.05 - KD 537.07
 150mm / 6"

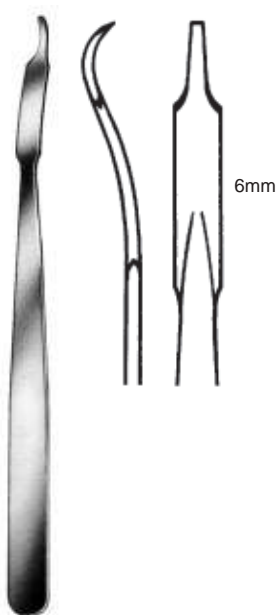

MINI - HOHMANN
KD 539.06
 160mm / 6 1/2"

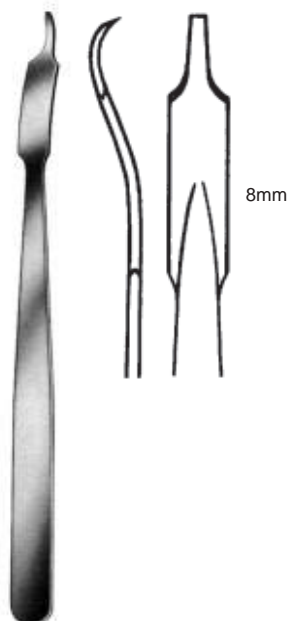

MINI - HOHMANN
KD 539.08
 160mm / 6 1/2"

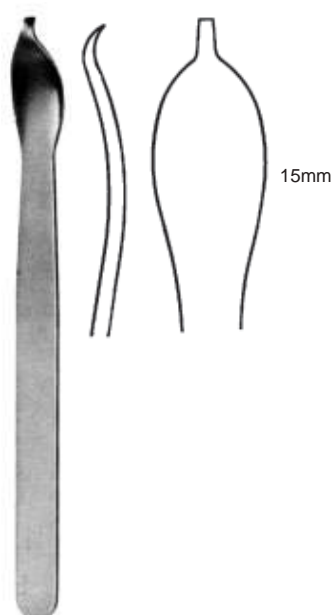

KD 539.15
 160mm / 6 1/2"

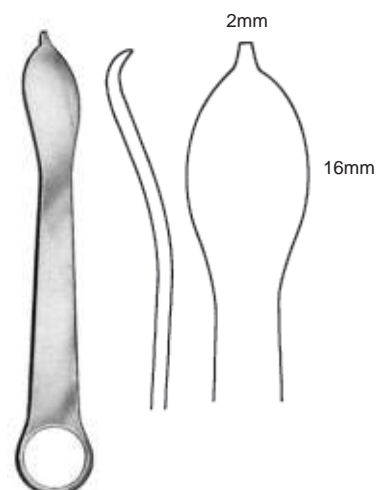

KD 539.16
 120mm / 4 3/4"



HOHMANN
KD 541.08
220mm / 8³/₄"

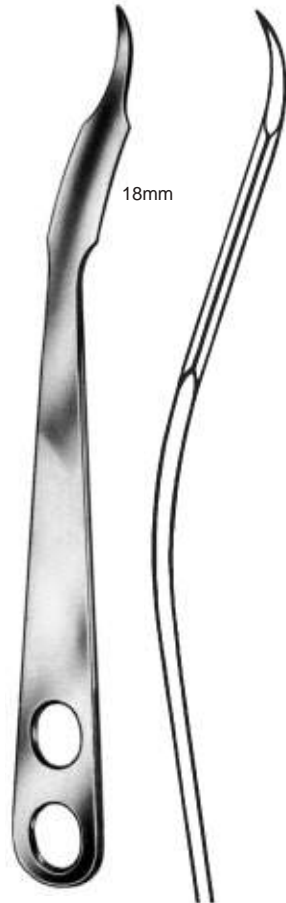

HOHMANN
KD 541.18
240mm / 9¹/₂"

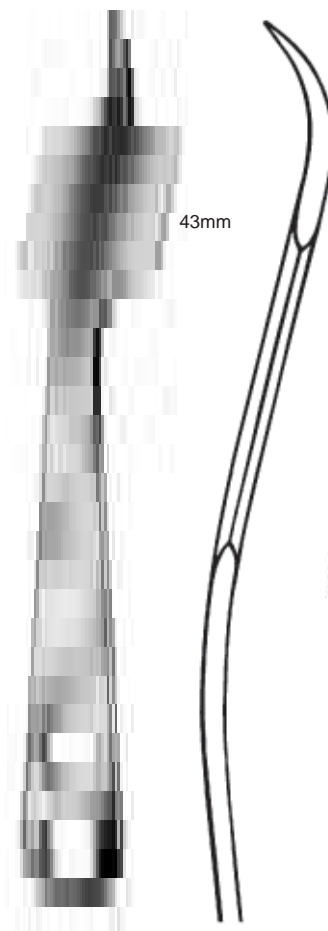

HOHMANN
KD 541.43
240mm / 9¹/₂"



HOHMANN
KD 541.70
240mm / 9¹/₂"



**HOHMANN
KD 543.43**
245mm / 9³/₄"



**HOHMANN
KD 545.22**
260mm / 10¹/₄"

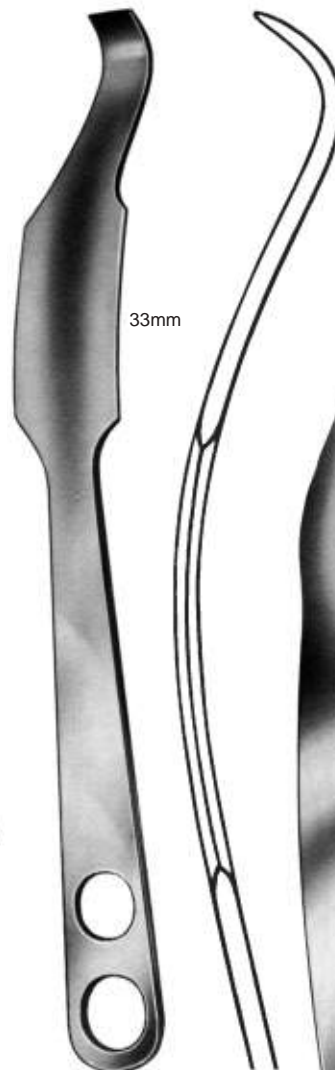

**HOHMANN
KD 545.33**
280mm / 11"



**HOHMANN
KD 547.24**
270mm / 10¹/₂"

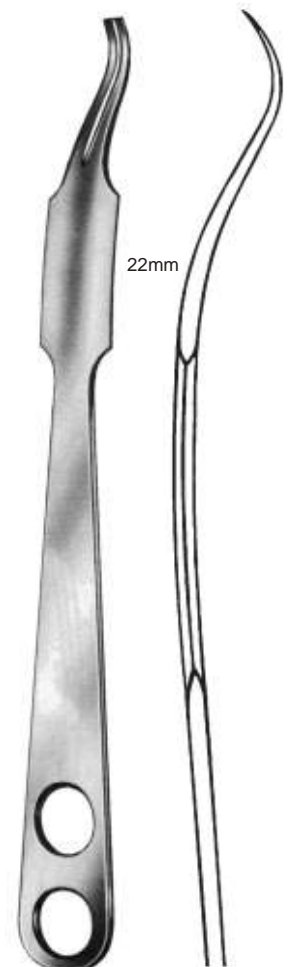

**LANGE - HOHMANN
KD 549.22**
260mm / 10¹/₄"

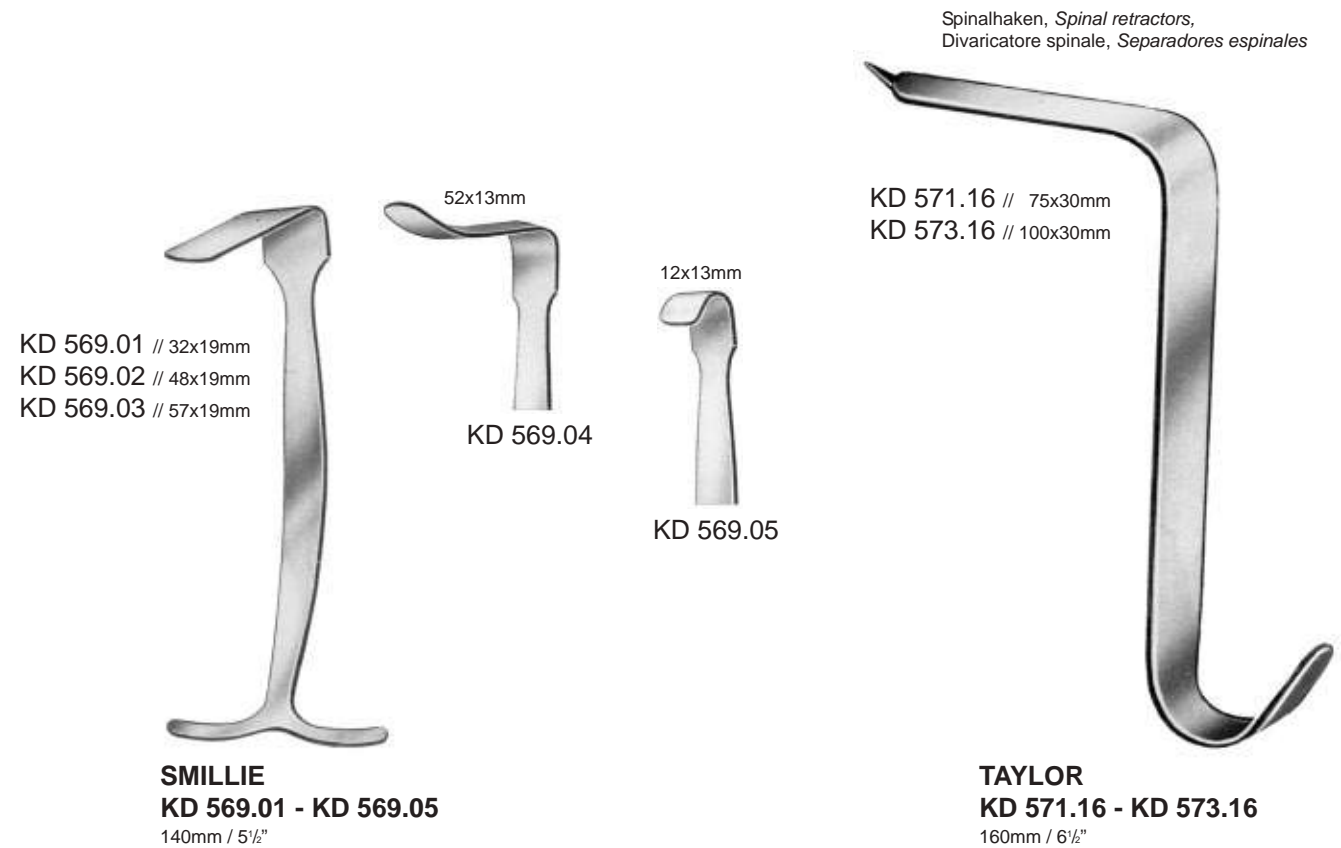
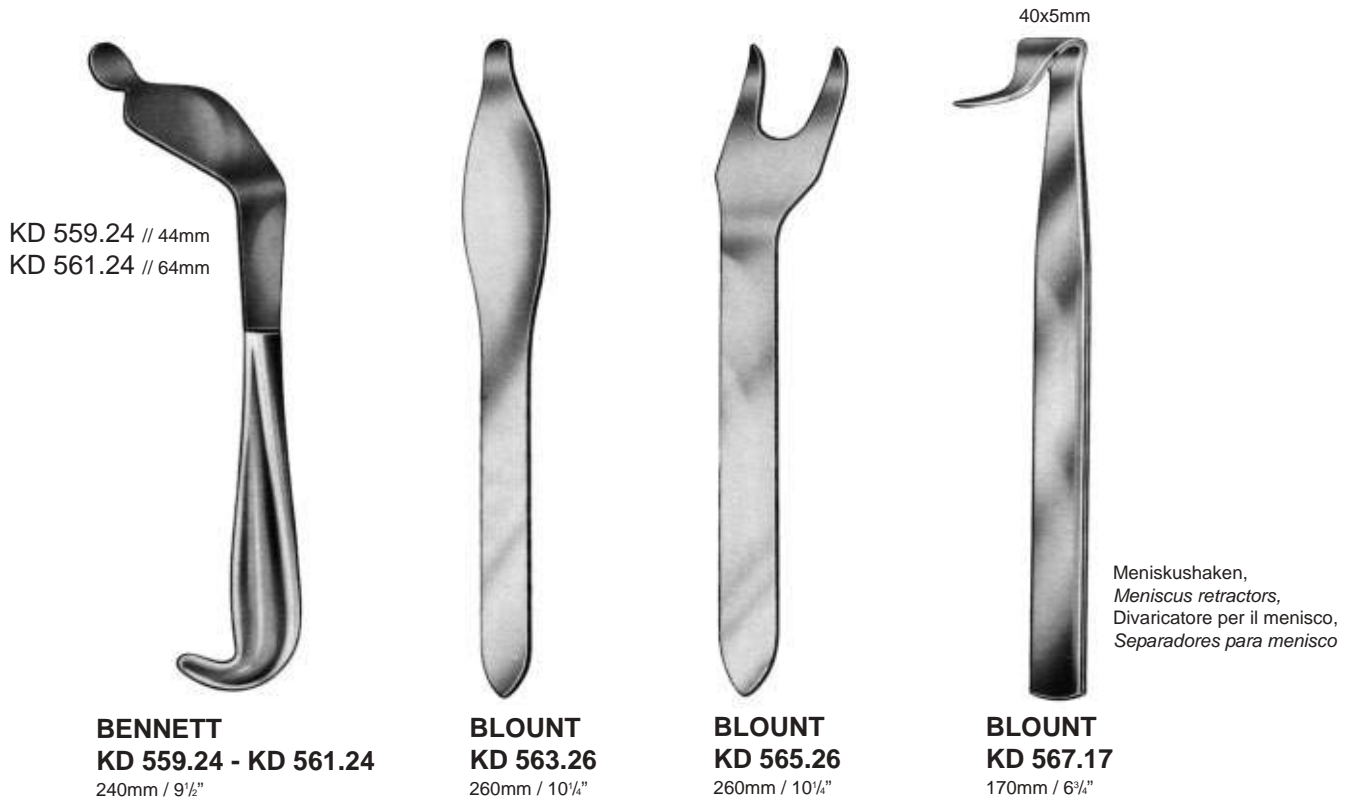



PERCY
KD 762.30

Griffe abnehmbar,
Handles detachable,
 Manici staccabile,
Mangos desmontable



LOWMAN
KH 387.12
 120mm / 4 3/4"



LOWMAN
KH 387.18 // 180mm / 7"
KH 387.20 // 200mm / 8"
KH 387.22 // 220mm / 8 3/4"



KH 700.20 - KH 701.20
 200mm / 8"



KH 700.20



KH 701.20



VAN BUREN
KH 705.23
 230mm / 9"

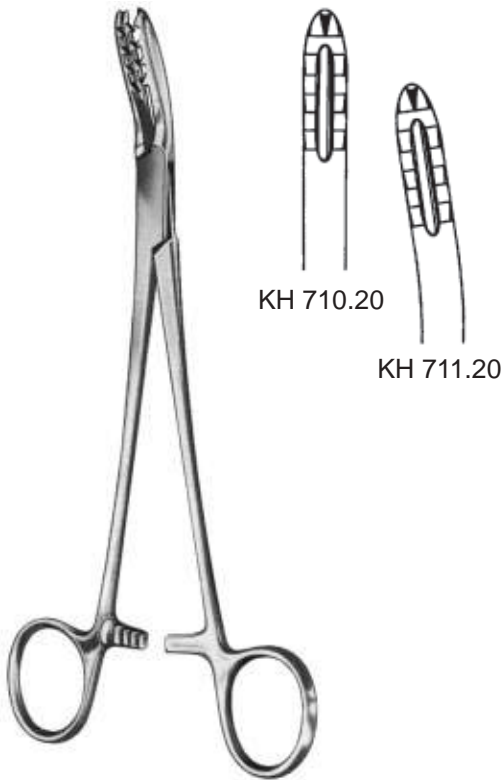

BIRCHER - GANSKE
KH 710.20 - KH 711.20
 200mm / 8"



BIRCHER - GANSKE
KH 713.20
 200mm / 8"



KH 714.14
 140mm / 5½"



DINGMANN
KH 715.19
 190mm / 7½"



MARTIN
KH 716.19
 190mm / 7½"



KH 717.12
 120mm / 4¾"



LEWIN
KH 718.17
170mm / 6 $\frac{1}{4}$ "



KH 719.16 // 160mm / 6 $\frac{1}{2}$ "
KH 719.24 // 240mm / 9 $\frac{1}{2}$ "



KH 720.14
140mm / 5 $\frac{1}{2}$ "



KH 721.14
140mm / 5 $\frac{1}{2}$ "



REILL
KH 721.17
170mm / 6 $\frac{3}{4}$ "



KH 721.20
200mm / 8"



LANGENBECK
KH 722.21
210mm / 8 1/4"

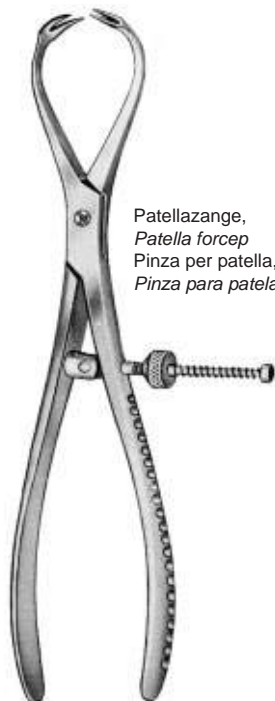

Patellazange,
Patella forcep
Pinza per patella,
Pinza para patela

KH 723.18
180mm / 7"



FERGUSSON
KH 724.21
210mm / 8 1/4"



FROSCH
KH 726.18
180mm / 7"



KH 727.20
200mm / 8"



Knochenhaltezangen
Bone Holding Forceps
Tenaglie per ossa
Pinzas para huesos



KH 728.17 // 170mm / 6³/₄"
KH 728.21 // 210mm / 8¹/₄"
 ohne Sperre,
without ratchet,
 senza cremagliera,
 sin cremallera

KH 730.17 // 170mm / 6³/₄"
KH 730.21 // 210mm / 8¹/₄"
 mit Sperre,
with ratchet,
 con cremagliera,
 con cremallera

KERN
KH 728.17 - KH 730.21



SEMB
KH 731.19
 190mm / 7¹/₂"



verstellbar,
adjustable,
 regolabile,
 ajustable

FARABEUF
KH 732.23 // 230mm / 9"
KH 732.26 // 260mm / 10¹/₄"



FARABEUF - LAMBOTTE
KH 734.26
 260mm / 10¹/₄"



LAMBOTTE
KH 740.22 // 220mm / 8³/₄"
KH 740.27 // 270mm / 10¹/₂"
KH 740.30 // 300mm / 12"



LAMBOTTE
KH 742.22 // 220mm / 8³/₄"
KH 742.27 // 270mm / 10¹/₂"
KH 742.30 // 300mm / 12"



LAMBOTTE
KH 745.19 // 190mm / 7¹/₂"
KH 745.23 // 230mm / 9"
KH 745.26 // 260mm / 10¹/₄"

verstellbar, *adjustable,* regolabile, *ajustable*

verstellbar, *adjustable,* regolabile, *ajustable*



ULRICH
KH 746.23 // 230mm / 9"
KH 746.25 // 250mm / 10"
KH 746.28 // 280mm / 11"



ULRICH
KH 747.23 // 230mm / 9"
KH 747.25 // 250mm / 10"
KH 747.28 // 280mm / 11"



KH 749.15 // 150mm / 6"
KH 749.19 // 190mm / 7½"
KH 749.24 // 240mm / 9½"
KH 749.26 // 260mm / 10¼"
KH 749.28 // 280mm / 11"

KH 750.33 // 330mm / 13"
KH 750.45 // 450mm / 17¼"
 ohne Sperre,
without ratchet,
 senza cremagliera,
sin cremallera

KH 752.33 // 330mm / 13"
KH 752.45 // 450mm / 17¼"
 mit Sperre,
with ratchet,
 con cremagliera,
con cremallera

LANE
KH 750.33 - KH 752.45

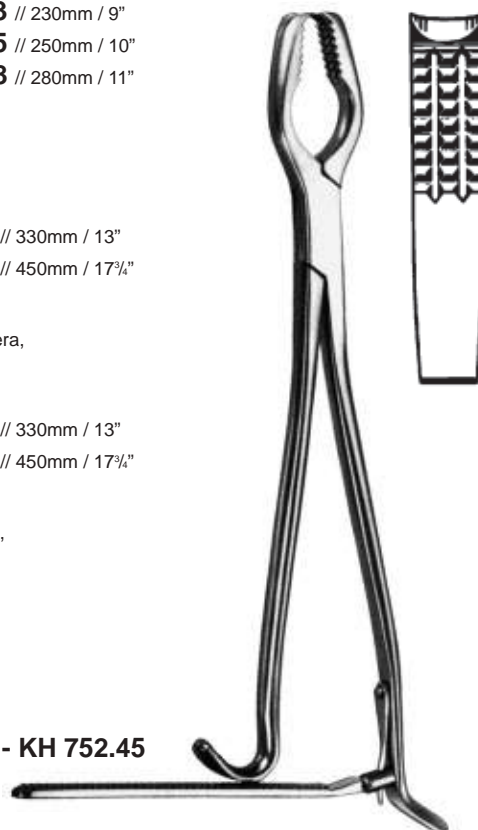



VERBRUGGE
KH 755.01 - KH 755.03

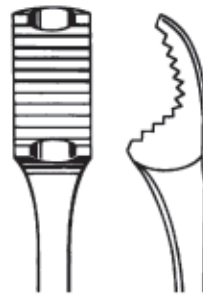

KH 755.01
250mm / 10"

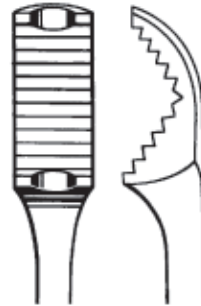

KH 755.02
260mm / 10 1/4"

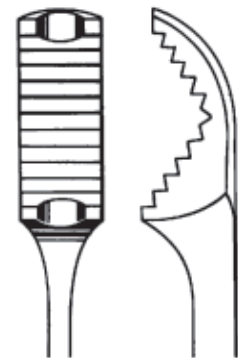

KH 755.03
270mm / 10 1/2"



VERBRUGGE
KH 757.17
170mm / 6 3/4"



STANDARD
 KH 771.01 - KH 771.02
 130mm / 5"



STANDARD
 KH 773.01 - KH 773.02
 130mm / 5"



JANSEN
 KH 775.19
 190 mm / 7½"

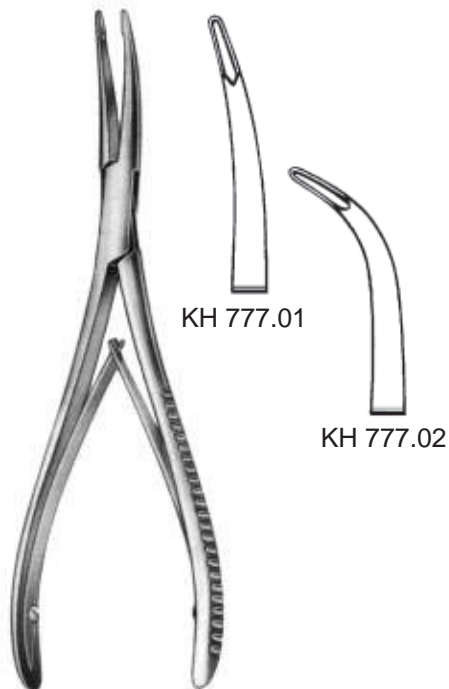

STELLBRINK
 KH 777.01 - KH 777.02
 170mm / 6½"



MINI - FRIEDMANN
 KH 799.12
 120mm / 5"



FRIEDMANN
 KH 801.14
 140mm / 5½"



FRIEDMANN
 KH 803.14
 140mm / 5½"



KH 805.14
 140mm / 5½"



KH 807.17
 170mm / 6¾"

CLEVELAND
 KH 805.14 - KH 807.17



MEAD
 KH 815.16
 160mm / 6½"



HARTMANN
 KH 819.18
 180mm / 7"



JANSEN
 KH 826.18 - KH 829.18
 180mm / 7"



KH 826.18



KH 827.18



KH 829.18



LEMPERT
 KH 832.19 - KH 833.19
 190mm / 7½"



KH 832.19



KH 833.19



KH 835.15



KH 837.15



KH 839.15

BLUMENTHAL
 KH 835.15 - KH 839.15

150mm / 6"



KH 846.17



KH 847.17

LUER
 KH 846.17 - KH 847.17

170mm / 6 3/4"



KH 853.15



KH 864.15



KH 865.15

LUER
 KH 853.15 - KH 865.15

150mm / 6"



OLIVECRONA
 KH 867.20

200mm / 8"



TROTTER
 KH 871.20

200mm / 8"



KH 876.15



KH 877.15

BÖHLER
 KH 876.15 - KH 877.15
 150mm / 6"



BEYER
 KH 879.18



ZAUFEL - JANSEN
 KH 881.18

BEYER // ZAUFEL - JANSEN
 KH 879.18 - KH 881.18
 180mm / 7"



MAYFIELD
 KH 883.17
 170mm / 6³/₄"



MARQUARDT
 KH 885.20
 200mm / 8"



KH 887.18
 180mm / 7"



KH 893.23
 230mm / 9"

RUSKIN
 KH 887.18 - KH 893.23

Hohlmeißelzangen
Bone Rongeur Forceps
 Pinze Sgorbie
 Pinzas Gubias

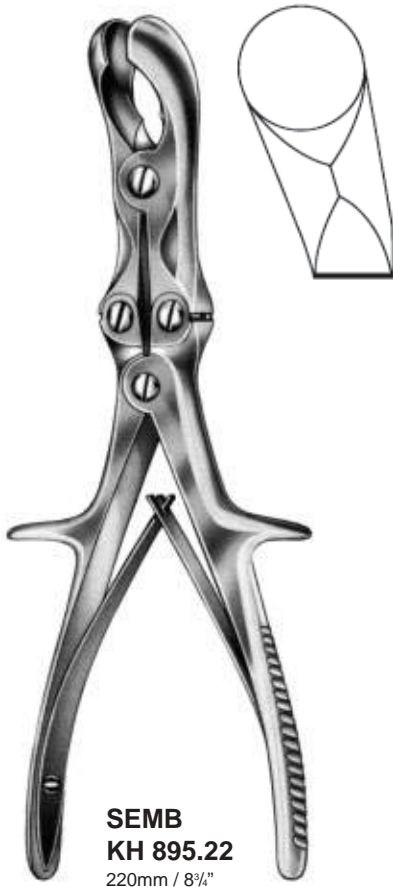

SEMB
KH 895.22
 220mm / 8³/₄"



STILLE
KH 897.23
 230mm / 9"



ECHLIN
KH 899.02 - KH 899.04
 230mm / 9"



KH 899.02



KH 899.03



KH 899.04



STILLE - RUSKIN
KH 901.23
 230mm / 9"



LEKSELL - STILLE
KH 905.24 - KH 907.24
 240mm / 9¹/₂"



KH 905.24



KH 907.24



FRYKHOLM
KH 909.24
 240mm / 9½"

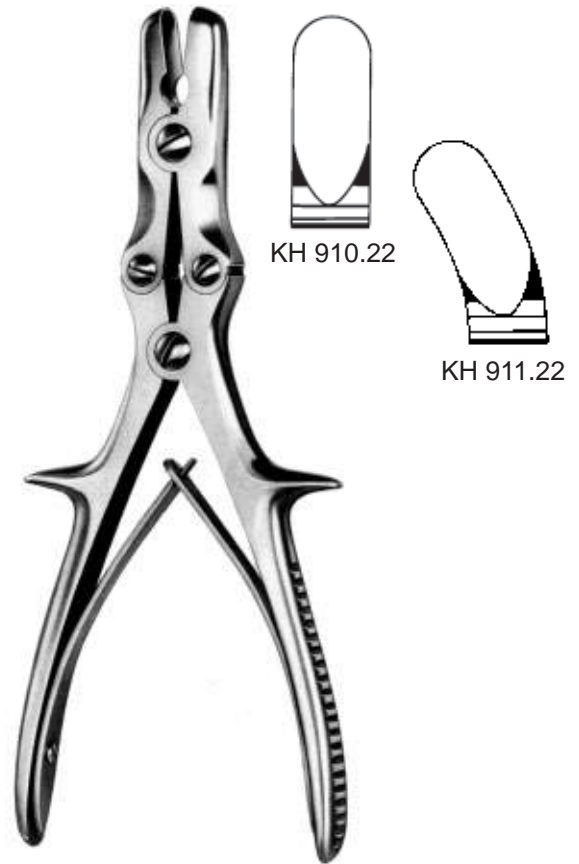

STILLE - LUER
KH 910.22 - KH 911.22
 220mm / 8¾"

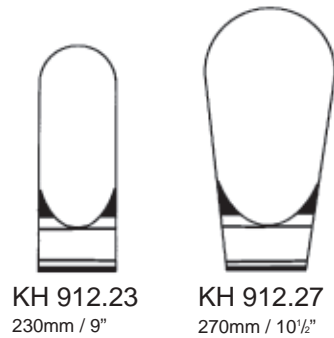

KH 912.23
 230mm / 9"

KH 912.27
 270mm / 10½"

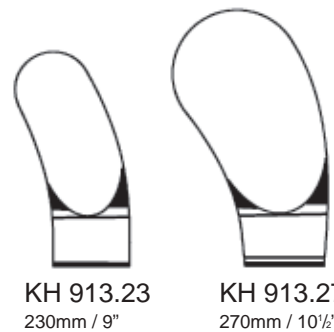

KH 913.23
 230mm / 9"

KH 913.27
 270mm / 10½"

STILLE - LUER
KH 912.23 - KH 913.27

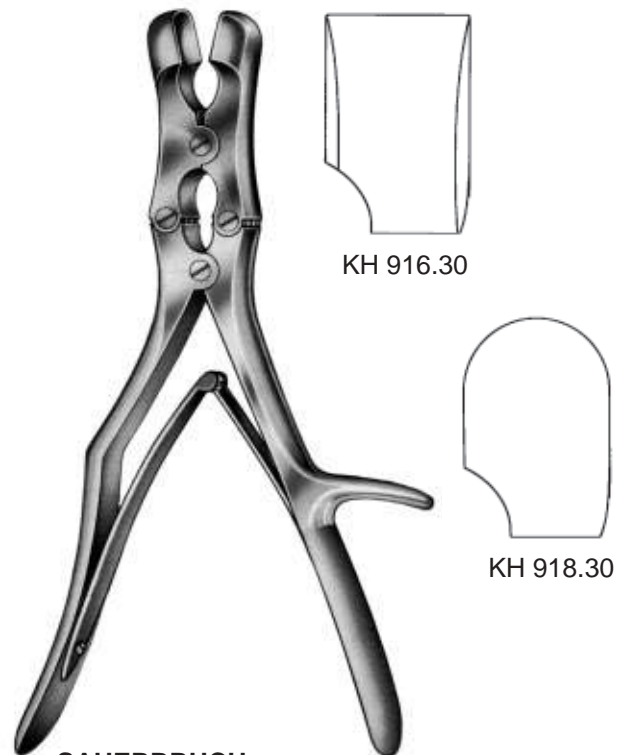

SAUERBRUCH
KH 916.30 - KH 918.30
 300mm / 12"



MARKWALDER
KH 928.20
 200mm / 8"



COTTLE - KAZANJIAN
KH 930.19
 190mm / 7½"



LISTON
KH 934.14 - KH 934.22

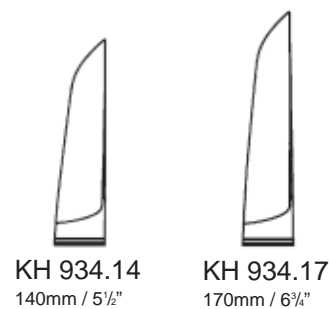

KH 934.14
 140mm / 5½"

KH 934.17
 170mm / 6¾"

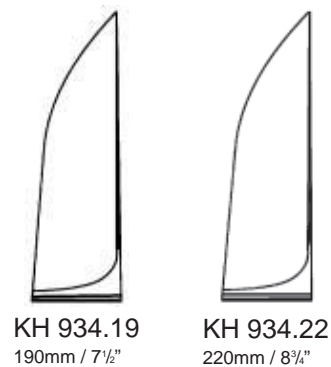

KH 934.19
 190mm / 7½"

KH 934.22
 220mm / 8¾"



LISTON
KH 935.14 - KH 935.22

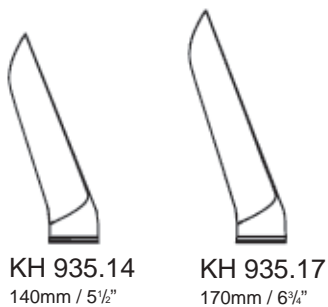

KH 935.14
 140mm / 5½"

KH 935.17
 170mm / 6¾"

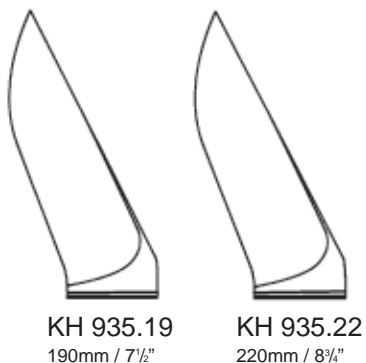

KH 935.19
 190mm / 7½"

KH 935.22
 220mm / 8¾"



CLEVELAND
KH 939.17
 170mm / 6¾"



CLEVELAND
KH 941.15
 150mm / 6"

Knochensplitterzangen
Bone Cutting Forceps
Pinze taglienti per ossa
Pinzas cortantes para huesos



KH 944.15

gerade,
straight,
 retta,
recta



KH 946.15

aufgebogen,
curved on flat,
 curva verso l'alto,
curva sobre el plano

BÖHLER
KH 944.15 - KH 946.15
 150mm / 6"



KH 950.18



KH 951.18

RUSKIN - LISTON
KH 950.18 - KH 951.18
 180mm / 7"



STILLE - LISTON
KH 952.27 - KH 955.27

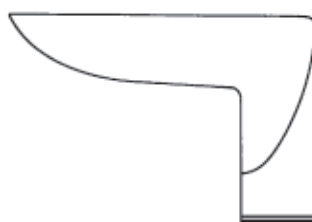

KH 952.27
 270mm / 10½"



KH 954.27
 270mm / 10½"



KH 955.23
 230mm / 9"



KH 955.27
 270mm / 10½"



LISTON - KEY
KH 957.27
270mm / 10 $\frac{1}{2}$ "



SEMB
KH 959.24
240mm / 9 $\frac{1}{2}$ "

CT - ORO



KI 500.01 - KI 500.12



KI 500.01
150mm / 6"

KI 500.02
180mm / 7"



KI 500.11
150mm / 6"

KI 500.12
180mm / 7"



KI 500.15 - KI 500.20



KI 500.15
150mm / 6"



KI 500.20
200mm / 8"

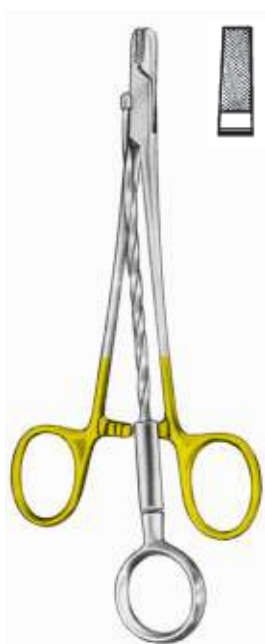

KI 502.16
160m / 6½"



KI 502.17
170m / 6¾"

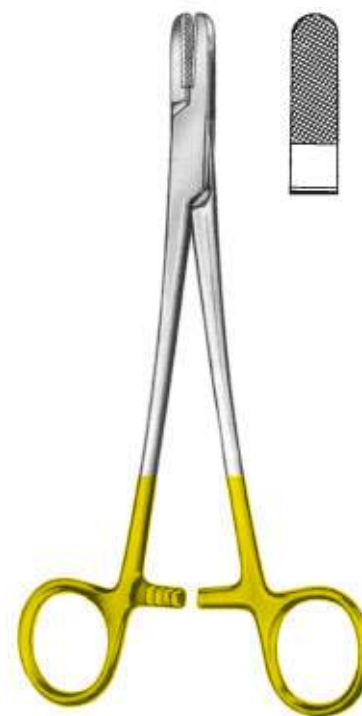

KI 506.18 // 180m / 7"
KI 506.20 // 200m / 8"

Flachzangen, Draht - Kneifzangen, Faßzangen
Flat Nose Pliers, Wire Cutting Pliers, Seizing Pliers
Tenaglie piatte, Tenaglie tagliafili, Tenaglie per afferrare
Alicates planos, Alicates para cortar alambre, Pinzas para coger



KI 505.17
170mm / 6 3/4"

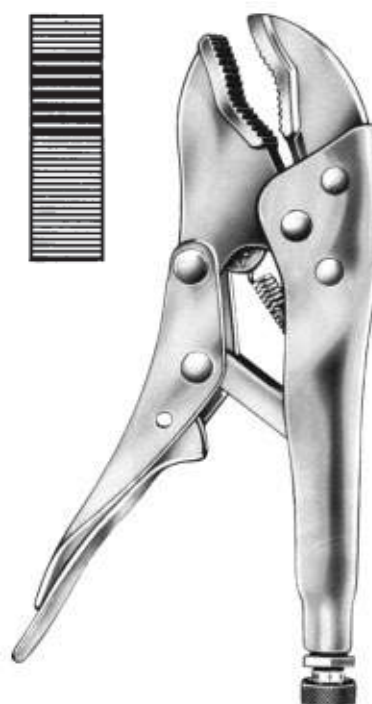

KI 507.18
180mm / 7"



KI 508.23
230mm / 9"



KI 508.25
250mm / 10"



KI 510.15
150mm / 6"



KI 510.18 - KI 514.18
 180mm / 7"

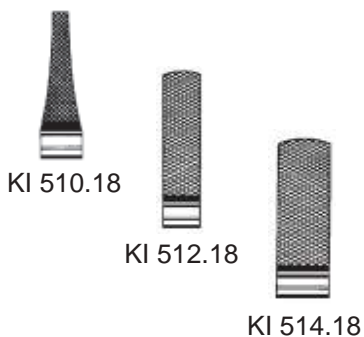

KI 511.01 - KI 511.03
 180mm / 7"

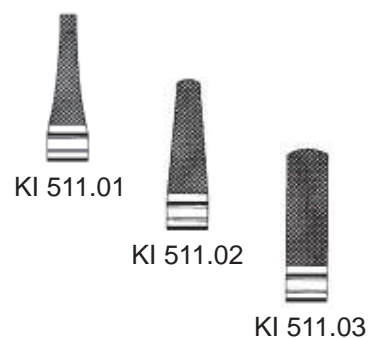

CT - ORO



KI 516.18
 180mm / 7"



KI 518.16
 160mm / 6 1/2"

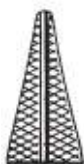

mit Rille,
 with groove,
 con scanalatura,
 con ranura



KI 519.01 - KI 519.02
 170mm / 6 3/4"



KI 519.01



KI 519.02

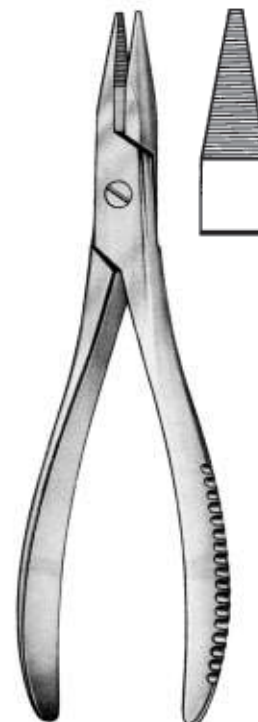

KI 519.03
 190mm / 7 1/2"





KI 520.16
 160mm / 6 1/2"
 2,0mm

für weiche Drähte bis Ø
 for soft wire with Ø max.
 per fili morbidi fino Ø
 para hilos blandos max. Ø



KI 522.16
 160mm / 6 1/2"
 1,7mm



KI 524.15
 150mm / 6"
 2,0mm

für harte Drähte bis Ø
 for hard wire with Ø max.
 per fili duri fino Ø
 para hilos duros max. Ø

2,0mm

1,7mm

2,0mm

CT - ORO



KI 523.16
 160mm / 6 1/2"
 2,0mm

für weiche Drähte bis Ø
 for soft wire with Ø max.
 per fili morbidi fino Ø
 para hilos blandos max. Ø



KI 523.22
 220mm / 8 3/4"
 3,0mm

für harte Drähte bis Ø
 for hard wire with Ø max.
 per fili duri fino Ø
 para hilos duros max. Ø

1,6mm

2,5mm









KI 526.18
 180mm / 7"
 2,0mm

1,5mm

Scharfe Löffel
Bone Curettes
Curette taglienti
Cucharillas cortantes



- 
KK 280.40
 Fig. 0000
- 
KK 280.30
 Fig. 000
- 
KK 280.20
 Fig. 00
- 
KK 280.10
 Fig. 0

- 
KK 280.01
 Fig. 1
- 
KK 280.02
 Fig. 2
- 
KK 280.03
 Fig. 3
- 
KK 280.04
 Fig. 4
- 
KK 280.05
 Fig. 5
- 
KK 280.06
 Fig. 6

Ferrozellgriff,
 Handle from artificial wood,
 Manico in Ferrozell,
 Mango de madera artificial

VOLKMANN
KK 280.40 - KK 280.06
 170mm / 6³/₄"



- 
KK 282.10
 Fig. 0
- 
KK 282.01
 Fig. 1
- 
KK 282.02
 Fig. 2
- 
KK 282.03
 Fig. 3
- 
KK 282.04
 Fig. 4

Ferrozellgriff,
 Handle from artificial wood,
 Manico in Ferrozell,
 Mango de madera artificial

VOLKMANN
KK 282.10 - KK 282.04
 270mm / 10¹/₂"

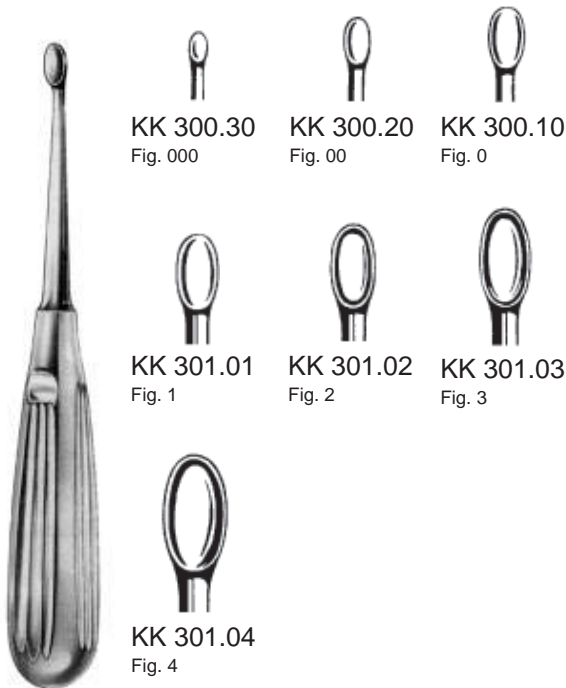

SCHEDÉ
KK 300.10 - KK 301.04

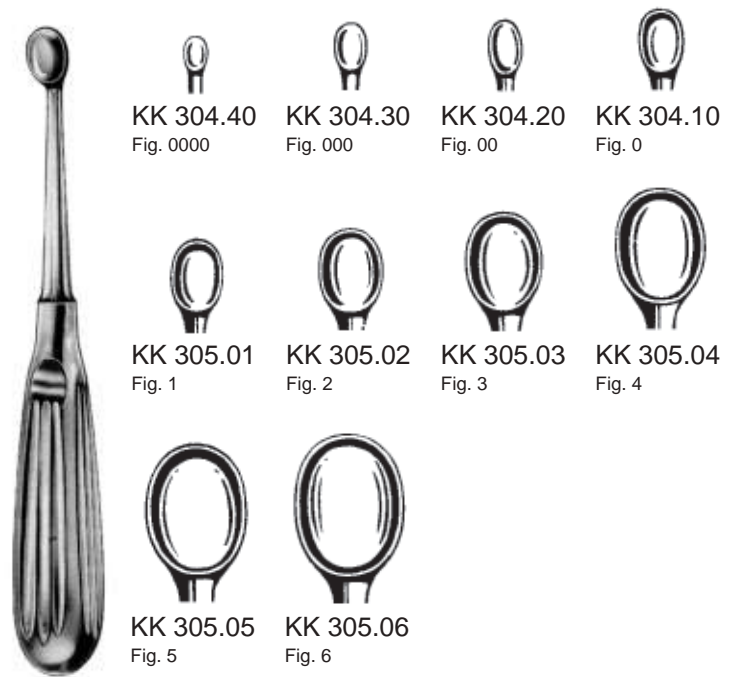

VOLKMANN
KK 304.40 - KK 305.06

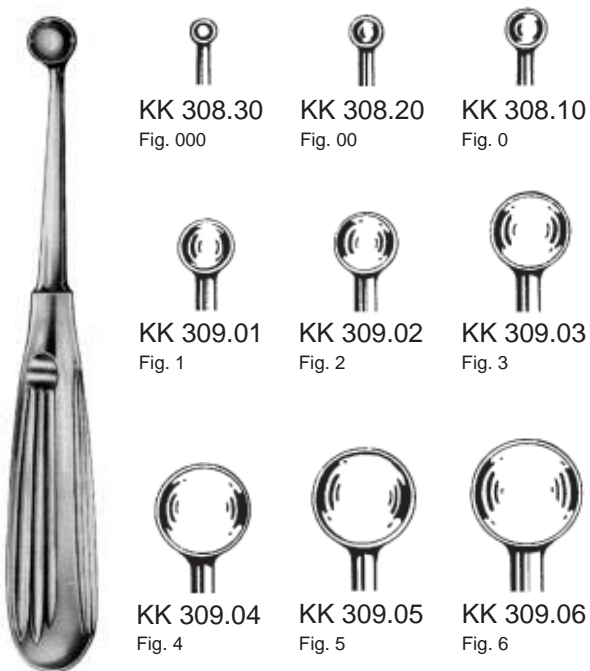

BRUNS
KK 308.30 - KK 309.06

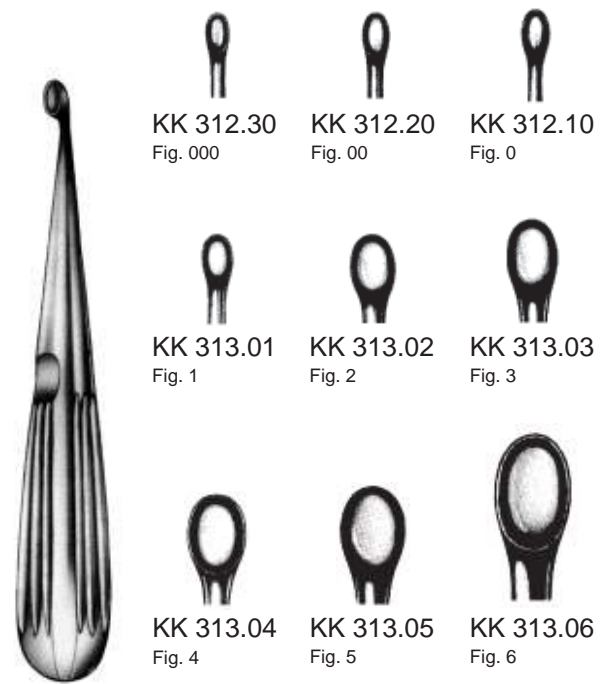

SPRATT
KK 312.30 - KK 313.06

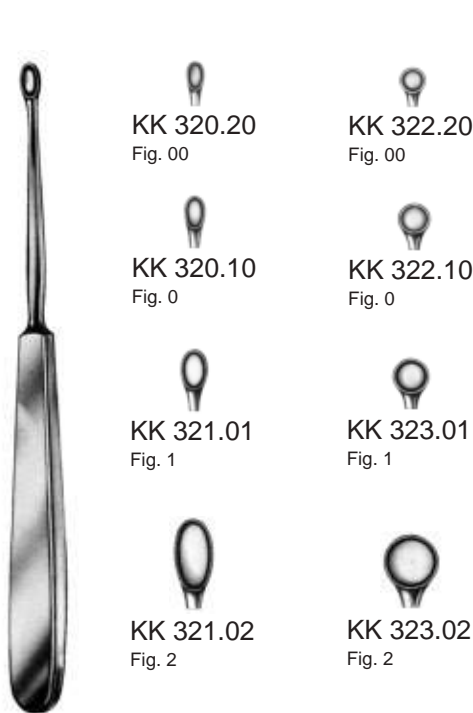

WILLIGER
 KK 320.20 - KK 323.02
 170mm / 6 3/4"

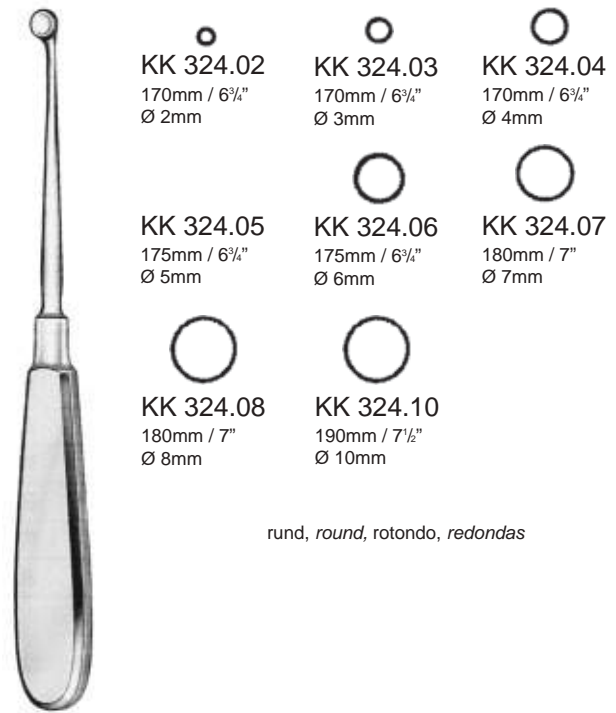

SCHWEDISCH PATTERN
 KK 324.02 - KK 324.10

rund, round, rotondo, redondas

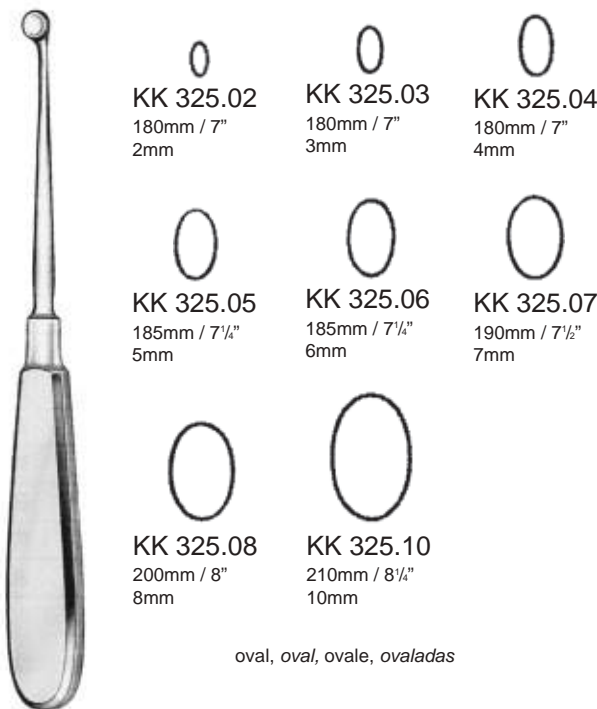

SCHWEDISCH PATTERN
 KK 325.02 - KK 325.10

oval, oval, ovale, ovaladas

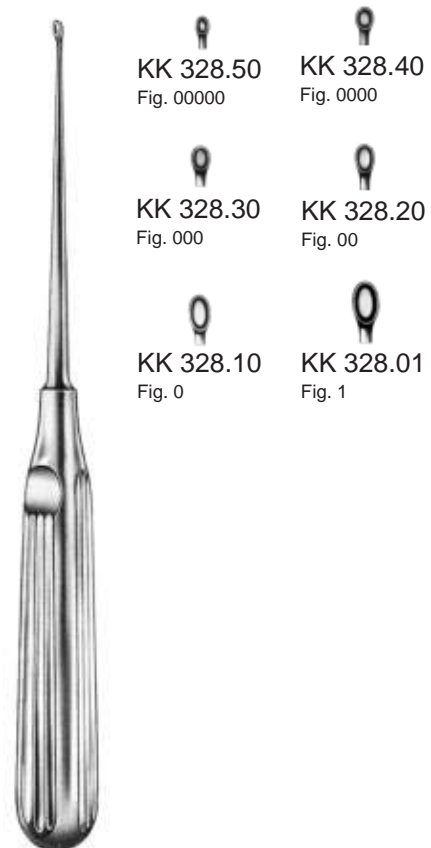

LEMPERT
 KK 328.50 - KK 328.01
 210mm / 8 1/4"



BRUNS
 KK 334.10 - KK 335.06
 230mm / 9"

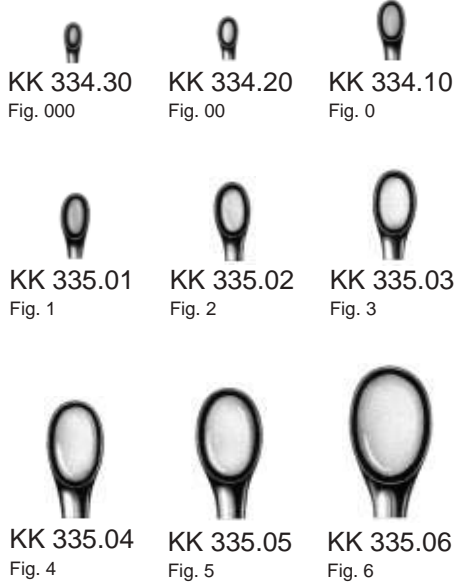

BRUNS
 KK 336.25 - KK 339.25
 250mm / 10"

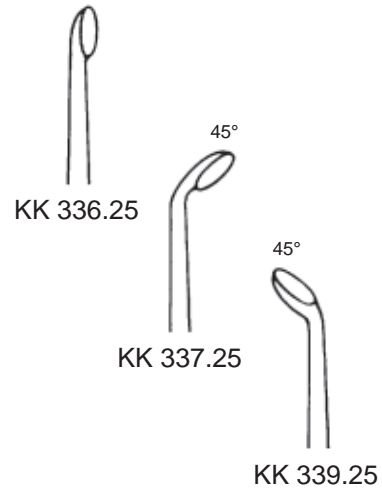

SIMON
 KK 340.01 - KK 340.06
 240mm / 9½"

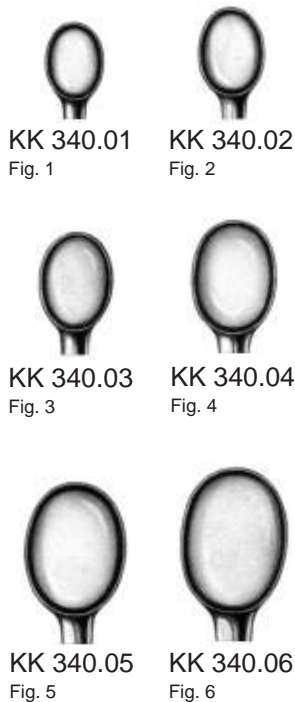

SIMON
 KK 342.40 - KK 342.10
 240mm / 9½"



Scharfe Löffel
Bone Curettes
Curette taglienti
Cucharillas cortantes

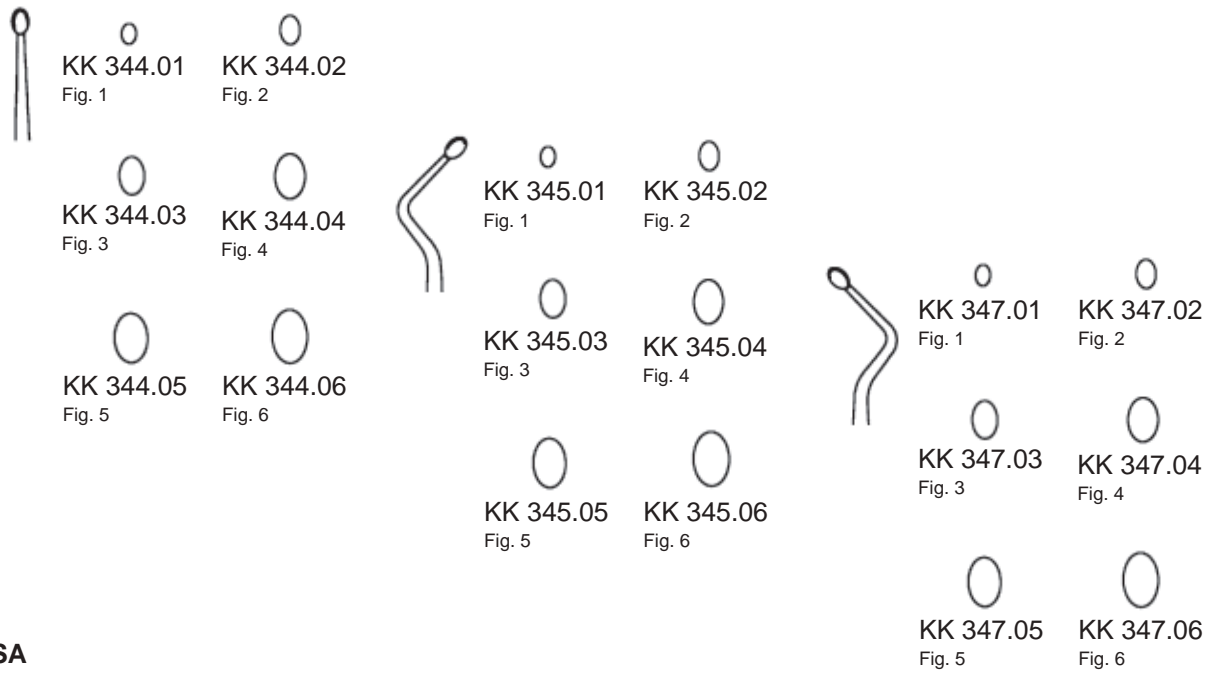

MOD. USA
KK 344.01 - KK 347.06
 160mm / 6½"



DAUBENSPECK
KK 348.20 - KK 348.02
 200mm / 8"



HALLE
KK 350.01 - KK 350.03
 210mm / 8¼"

*biegsam,
 malleable,
 malleabili,
 flexibles*

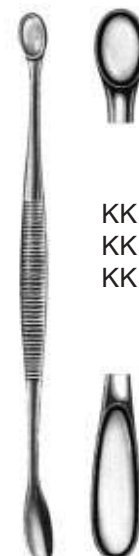

VOLKMANN
KK 352.13 - KK 352.17

KK 352.13 // 130mm / 5"
 KK 352.14 // 140mm / 5½"
 KK 352.17 // 170mm / 6¾"



VOLKMANN
KK 354.13
 130mm / 5"



VOLKMANN
KK 354.16
 160mm / 6 1/2"



VOLKMANN
KK 354.20
 200mm / 8"



KK 356.21
 210mm / 8 1/4"



WILLIGER
KK 358.00 - KK 358.12
 135mm / 5 1/4"

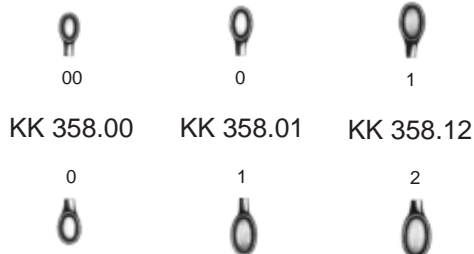

MARTINI
KK 362.00 - KK 362.12
 135mm / 5 1/4"

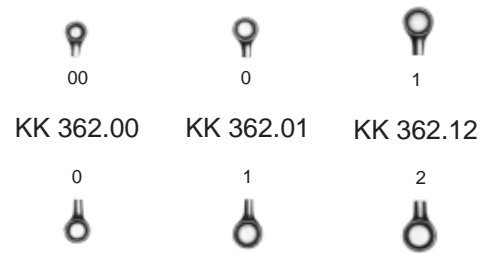

Meißel und Osteotome
Bone Chisels and Gouges
Scalpelli ed Osteotomi
Cinceles y gubias para huesos

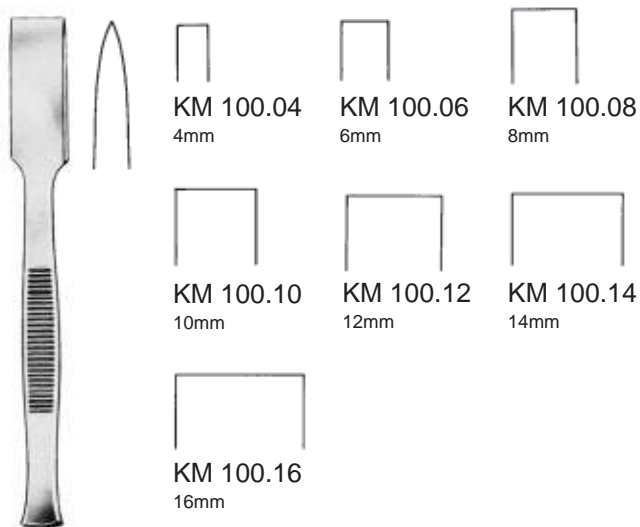

KM 100.04 - KM 100.16
 135mm / 5 1/4"

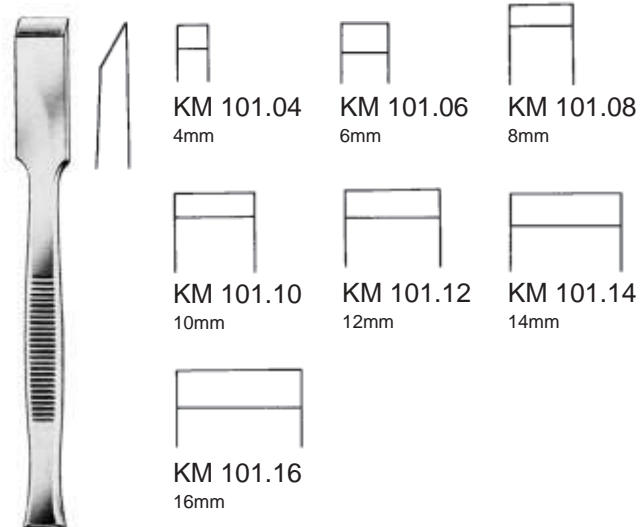

KM 101.04 - KM 101.16
 135mm / 5 1/4"

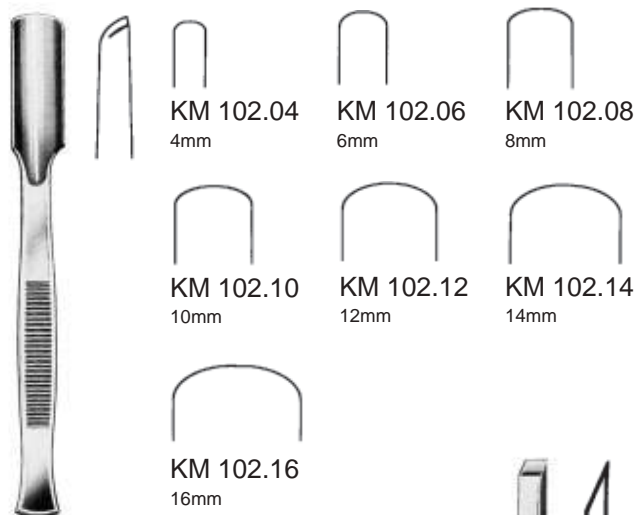

KM 102.04 - KM 102.16
 135mm / 5 1/4"

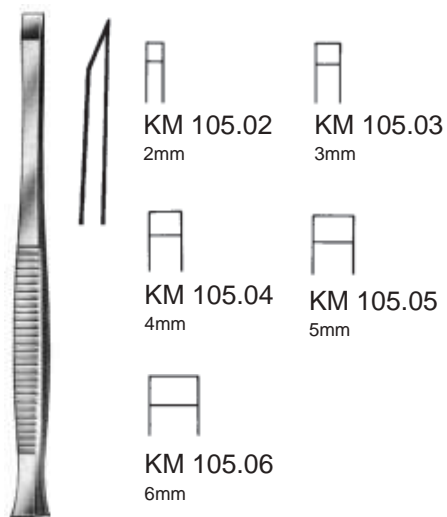

PARTSCH
KM 105.02 - KM 105.06
 135mm / 5 1/4"

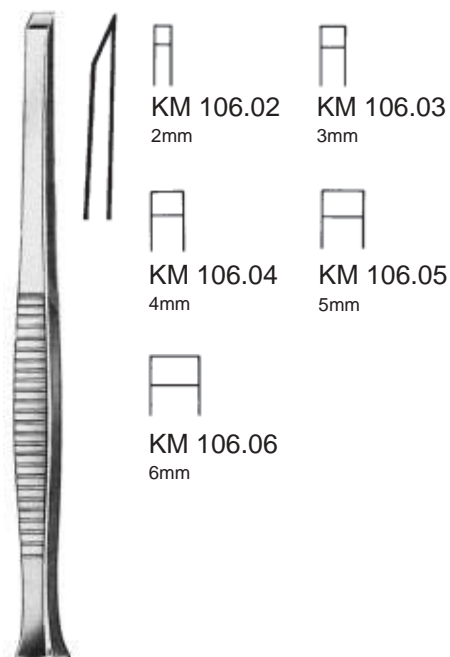

PARTSCH
KM 106.02 - KM 106.06
 170mm / 6 3/4"

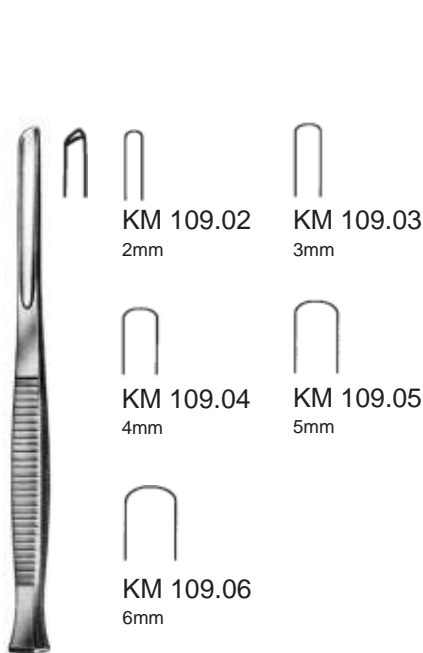

PARTSCH
KM 109.02 - KM 109.06
 135mm / 5¼"

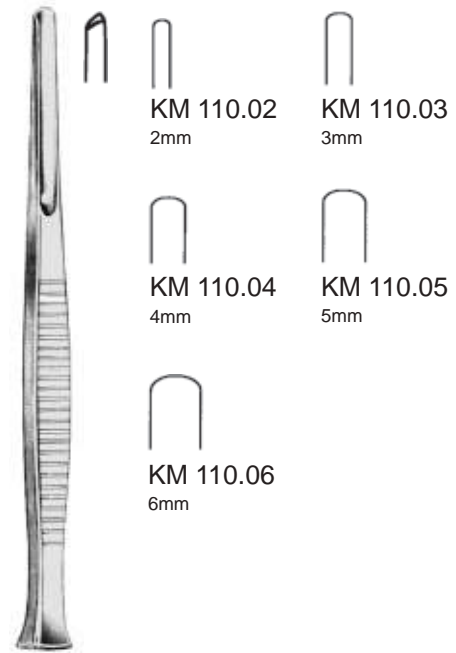

PARTSCH
KM 110.02 - KM 110.06
 170mm / 6½"

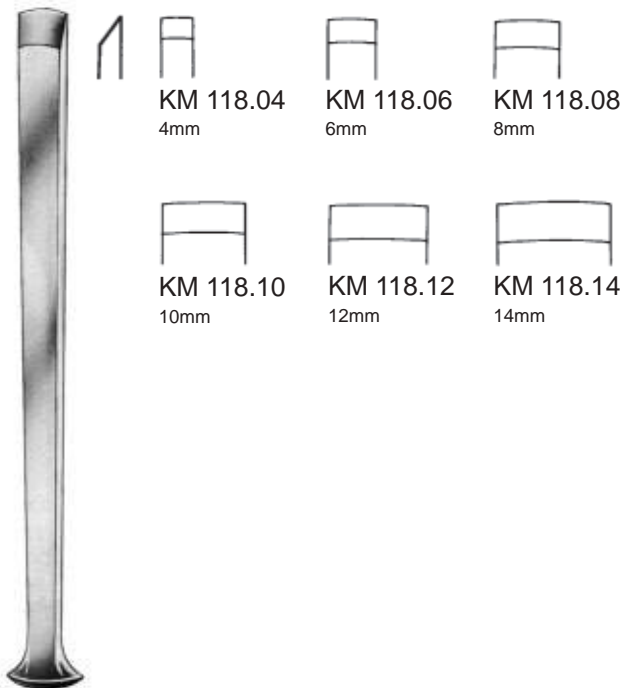

ALEXANDER
KM 118.04 - KM 118.14
 180mm / 7"

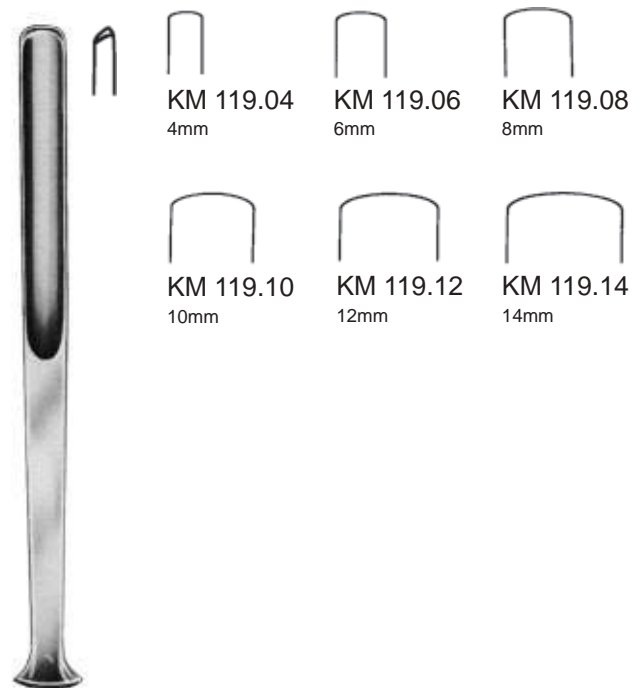

ALEXANDER
KM 119.04 - KM 119.14
 180mm / 7"



KM 122.06
6mm

KM 122.08
8mm

KM 122.10
10mm

KM 122.12
12mm

KM 122.15
15mm

KM 122.20
20mm

KM 122.25
25mm

STILLE
KM 122.06 - KM 122.25
 200mm / 8"



KM 123.06
6mm

KM 123.08
8mm

KM 123.10
10mm

KM 123.12
12mm

KM 123.15
15mm

KM 123.20
20mm

KM 123.25
25mm

STILLE
KM 123.06 - KM 123.25
 200mm / 8"



KM 124.06
6mm

KM 124.08
8mm

KM 124.10
10mm

KM 124.12
12mm

KM 124.15
15mm

KM 124.20
20mm

KM 124.25
25mm

STILLE
KM 124.06 - KM 124.25
 200mm / 8"



STILLE
KM 126.06 - KM 126.25
 200mm / 8"

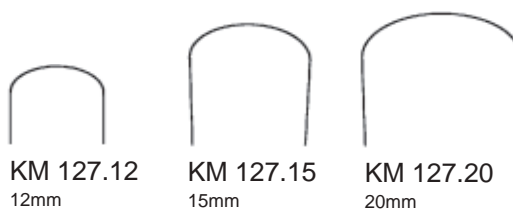

STILLE
KM 127.06 - KM 127.25
 200mm / 8"

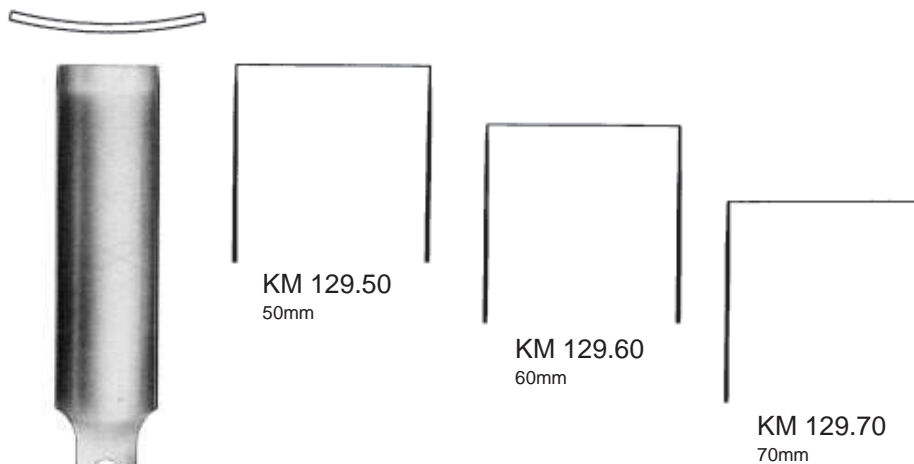

Griff, allein
 Handle, only
 Manico solo
 Mango suelto

KM 130.00



Schlüssel,
 Wrench,
 Chiave,
 Llave

KM 130.99

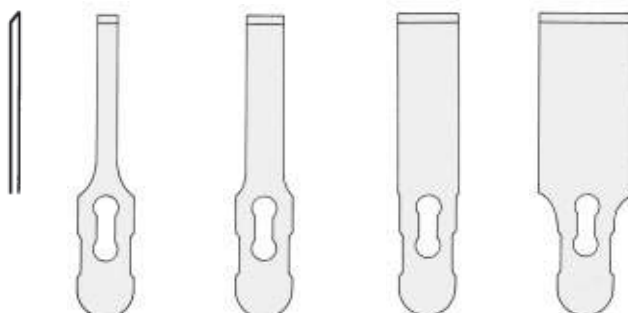

KM 130.05
5mm

KM 130.10
10mm

KM 130.16
16mm

KM 130.25
25mm

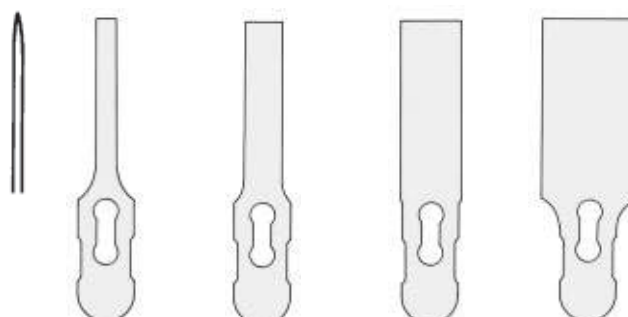

KM 130.55
5mm

KM 130.60
10mm

KM 130.66
16mm

KM 130.85
25mm

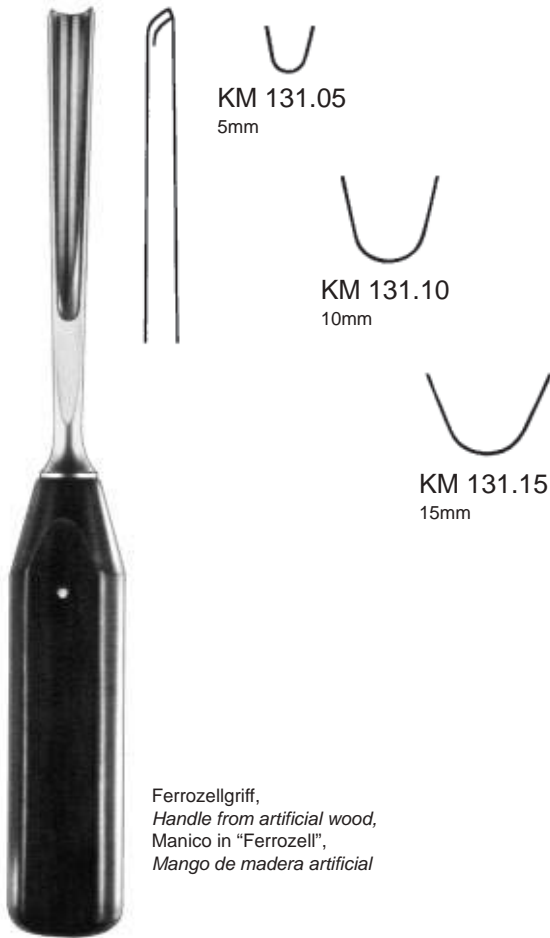

Ferrozellgriff,
 Handle from artificial wood,
 Manico in "Ferrozell",
 Mango de madera artificial

LEXER
KM 131.05 - KM 131.15
 250mm / 10"



Ferrozellgriff,
 Handle from artificial wood,
 Manico in "Ferrozell",
 Mango de madera artificial

LEXER
KM 131.55 - KM 131.65
 250mm / 10"

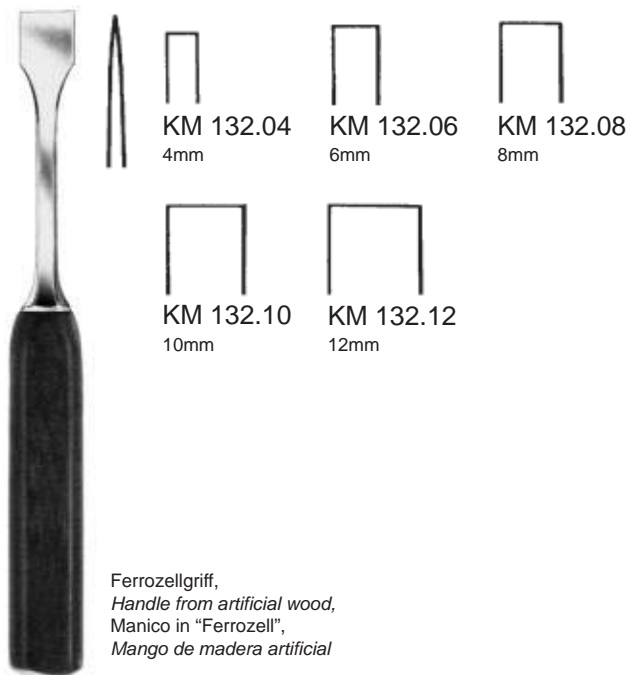

Ferrozellgriff,
 Handle from artificial wood,
 Manico in "Ferrozell",
 Mango de madera artificial

MINI - LEXER
KM 132.04 - KM 132.12
 180mm / 7"

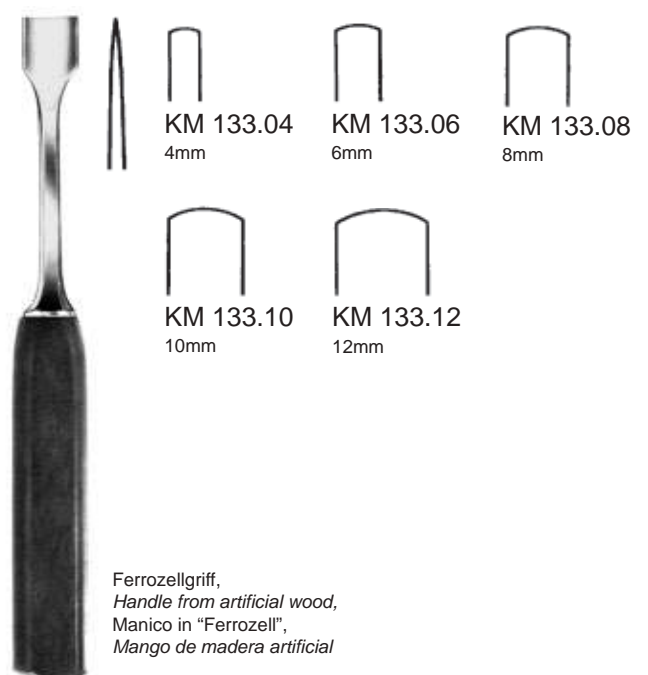

Ferrozellgriff,
 Handle from artificial wood,
 Manico in "Ferrozell",
 Mango de madera artificial

MINI - LEXER
KM 133.04 - KM 133.12
 180mm / 7"

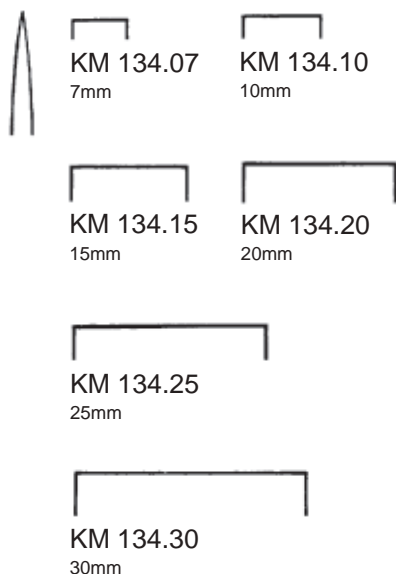

Ferrozellgriff,
 Handle from artificial wood,
 Manico in "Ferrozell",
 Mango de madera artificial

LEXER
KM 134.07 - KM 134.30
 220mm / 8³/₄"

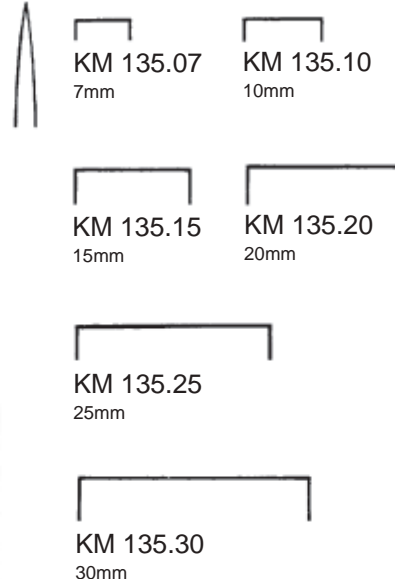

Ferrozellgriff,
 Handle from artificial wood,
 Manico in "Ferrozell",
 Mango de madera artificial

LEXER
KM 135.07 - KM 135.30
 220mm / 8³/₄"

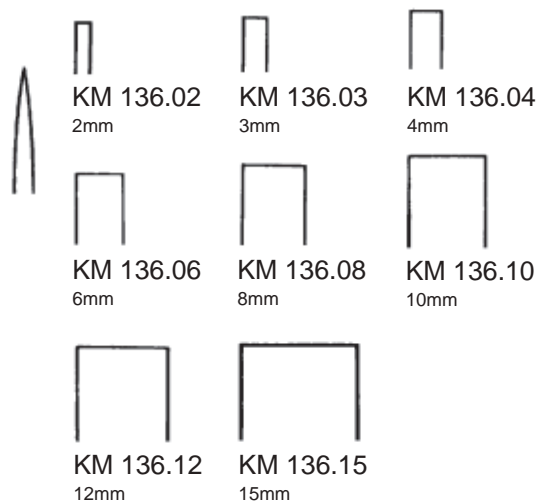

MINI - LAMBOTTE
KM 136.02 - KM 136.15
 130mm / 5"

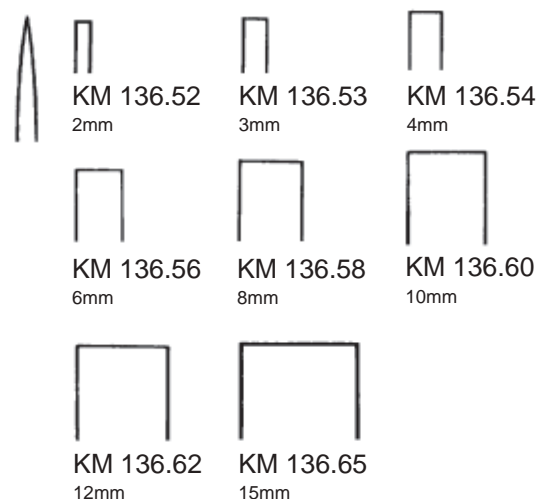

MINI - LAMBOTTE
KM 136.52 - KM 136.65
 170mm / 6³/₄"

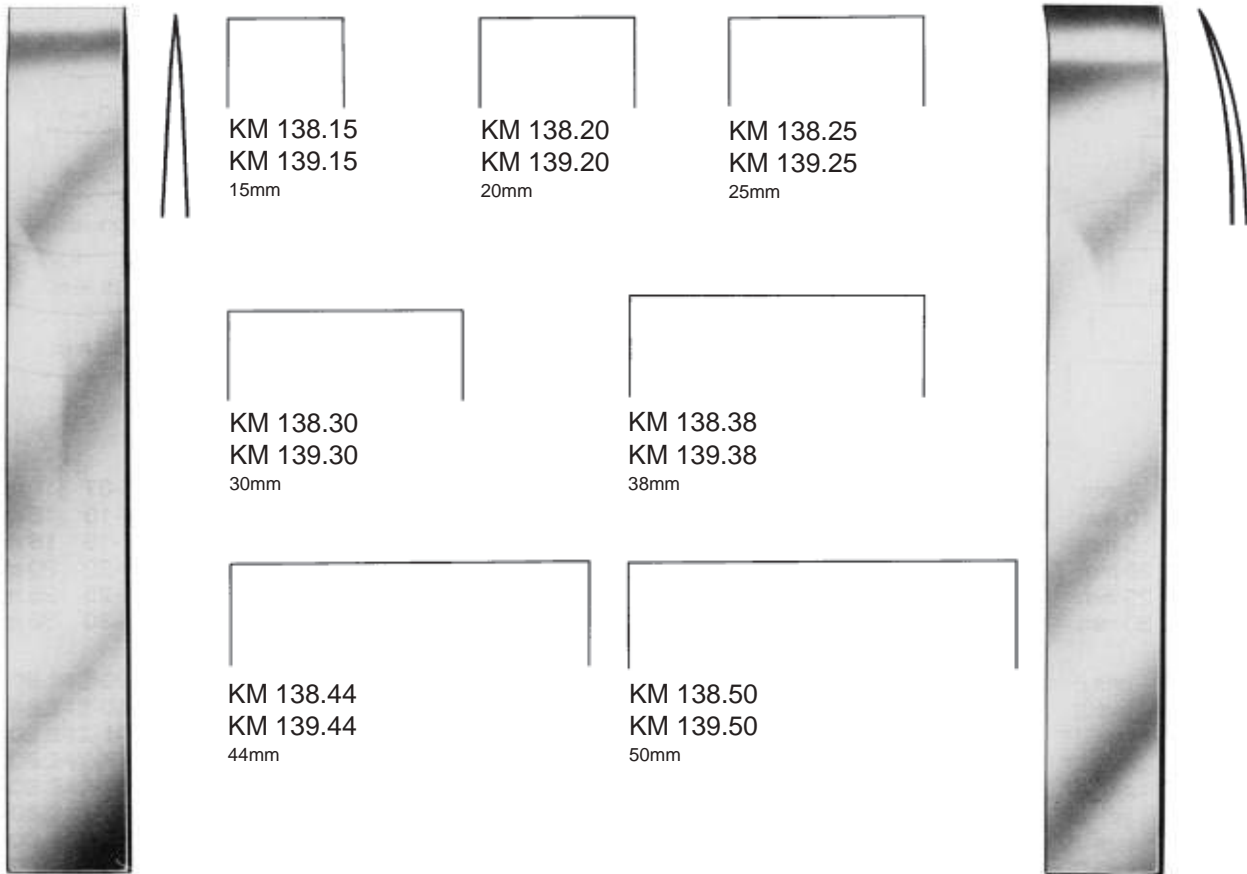

LAMBOTTE
KM 138.15 - KM 138.50
 240mm / 9½"

LAMBOTTE
KM 139.15 - KM 139.50
 240mm / 9½"

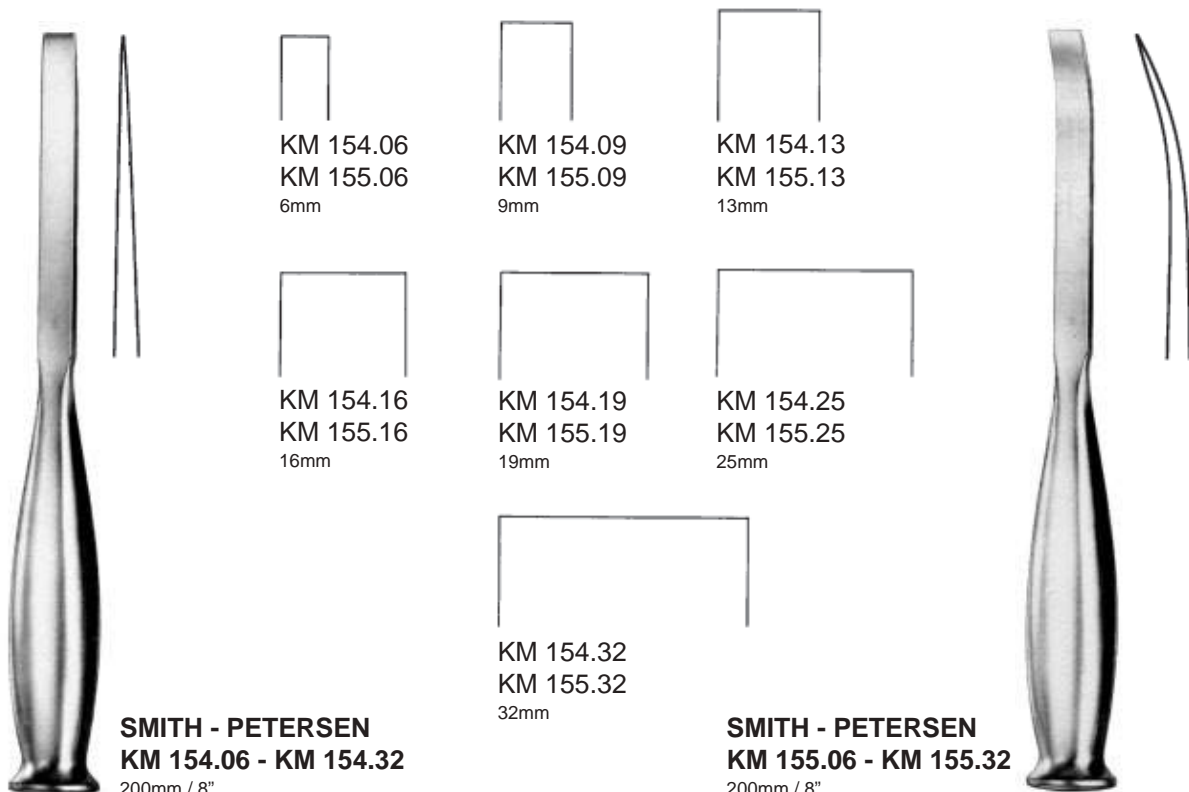

SMITH - PETERSEN
KM 154.06 - KM 154.32
 200mm / 8"

SMITH - PETERSEN
KM 155.06 - KM 155.32
 200mm / 8"



KM 156.09
 KM 157.09
 9mm

KM 156.14
 KM 157.14
 14mm

KM 156.19
 KM 157.19
 19mm

KM 156.25
 KM 157.25
 25mm

KM 156.32
 KM 157.32
 32mm

SMITH - PETERSEN
KM 156.09 - KM 156.32
 200mm / 8"

SMITH - PETERSEN
KM 157.09 - KM 157.32
 200mm / 8"



KM 162.03
 3mm

KM 162.05
 5mm

KM 162.06
 6mm

KM 162.08
 8mm

KM 162.09
 9mm

HOKE
KM 162.03 - KM 162.09
 170mm / 6 3/4"



KM 170.06
 6mm

KM 170.13
 13mm

KM 170.19
 19mm

KM 170.25
 25mm

KM 170.32
 32mm

HIBBS
KM 170.06 - KM 170.32
 240mm / 9 1/2"

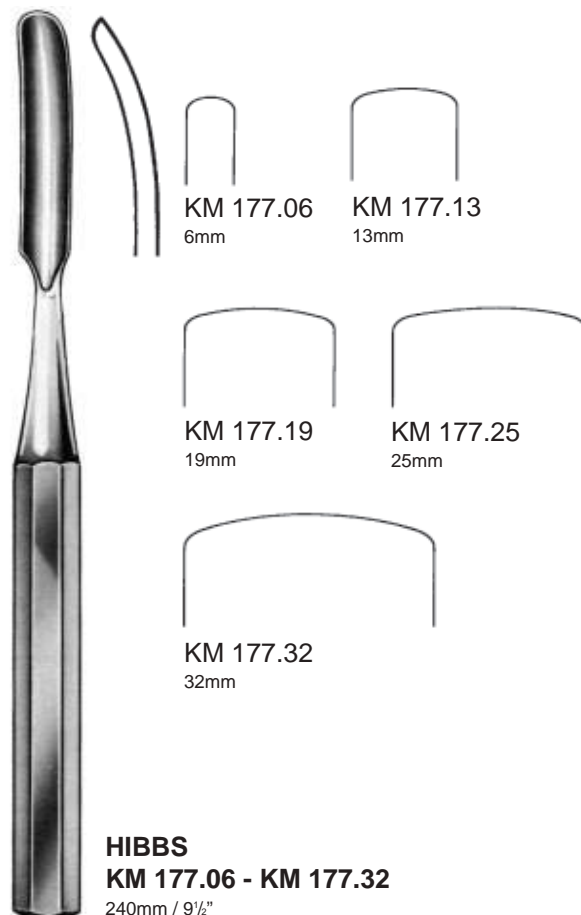
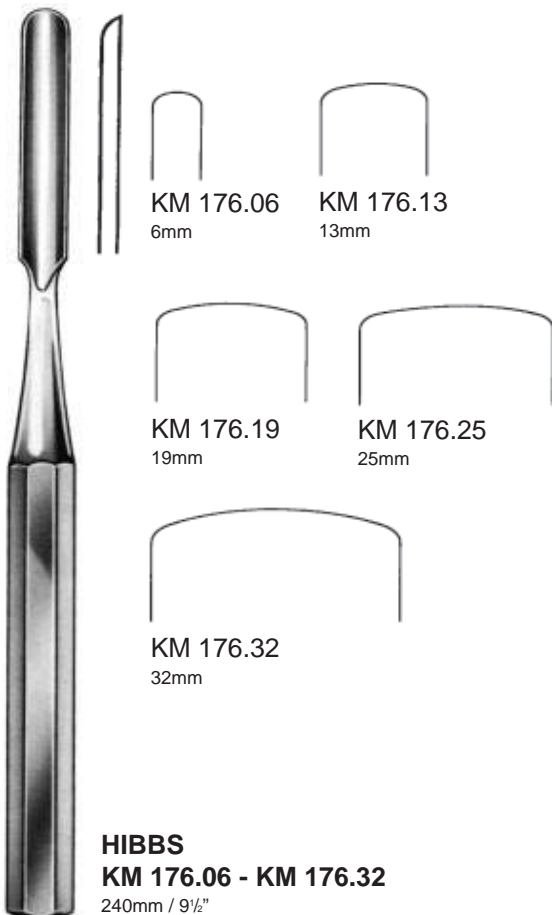
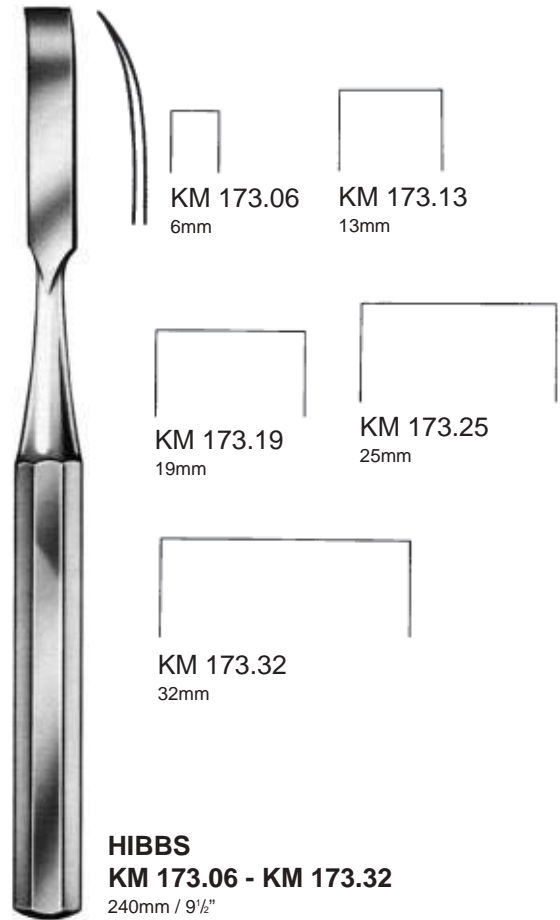
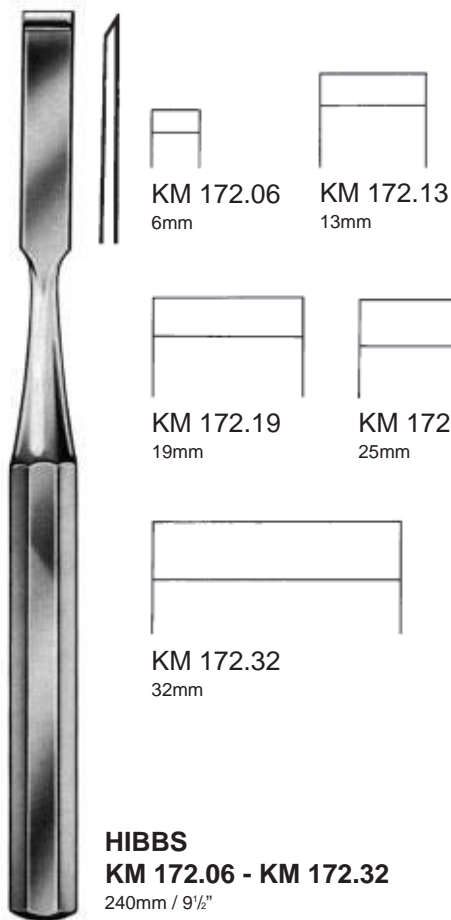



PUTTI
KN 181.30
 300mm / 12"

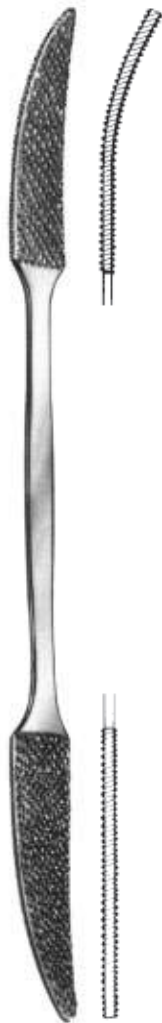

PUTTI
KN 183.27
 270mm / 10½"

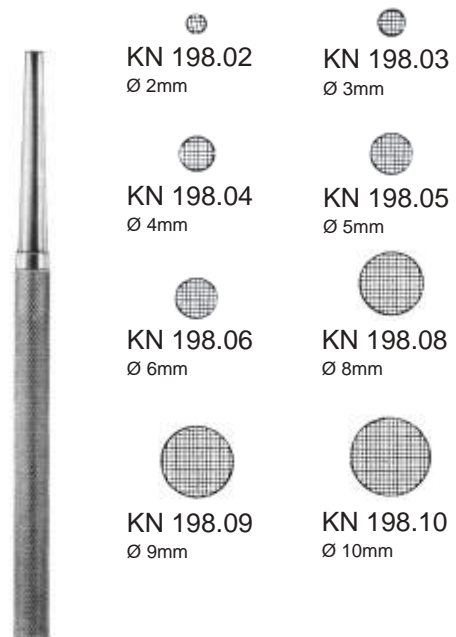

KN 198.02 - KN 198.10
 160mm / 6½"

KN 198.02
 Ø 2mm

KN 198.03
 Ø 3mm

KN 198.04
 Ø 4mm

KN 198.05
 Ø 5mm

KN 198.06
 Ø 6mm

KN 198.08
 Ø 8mm

KN 198.09
 Ø 9mm

KN 198.10
 Ø 10mm

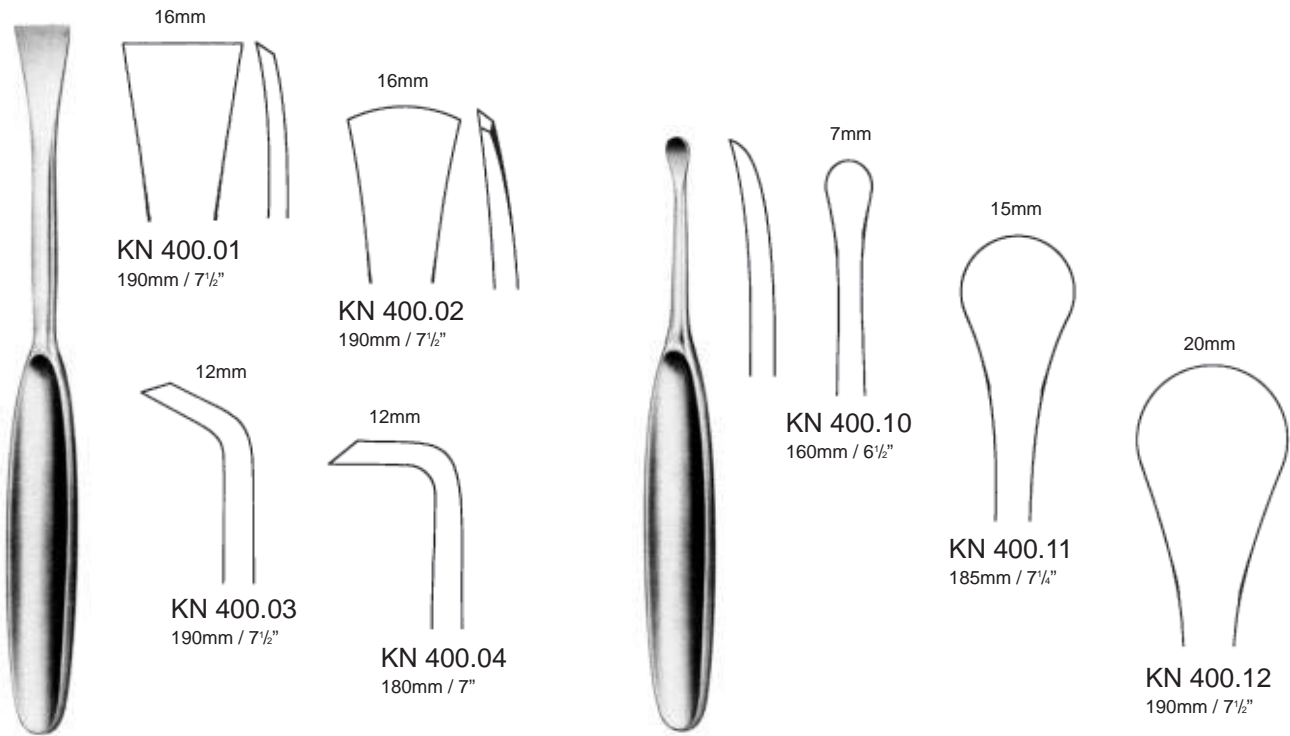

LANGENBECK
 KN 400.01 - KN 400.04

HOEN
 KN 400.10 - KN 400.12

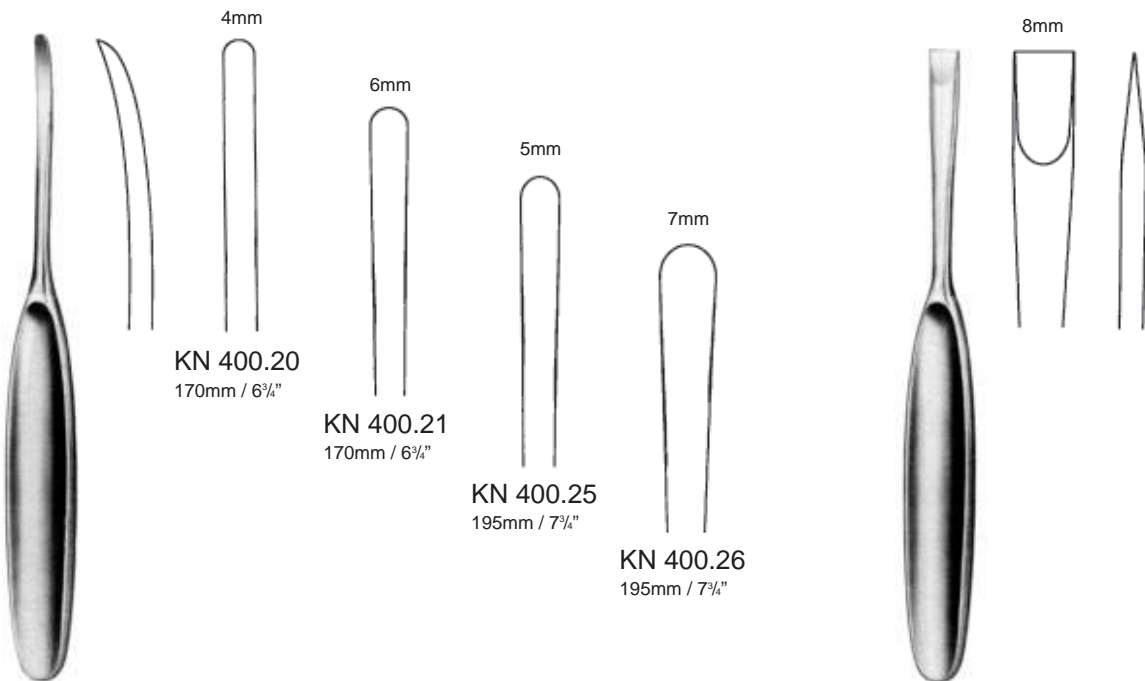

CUSHING
 KN 400.20 - KN 400.26

CUSHING
 KN 400.30
 170mm / 6¾"

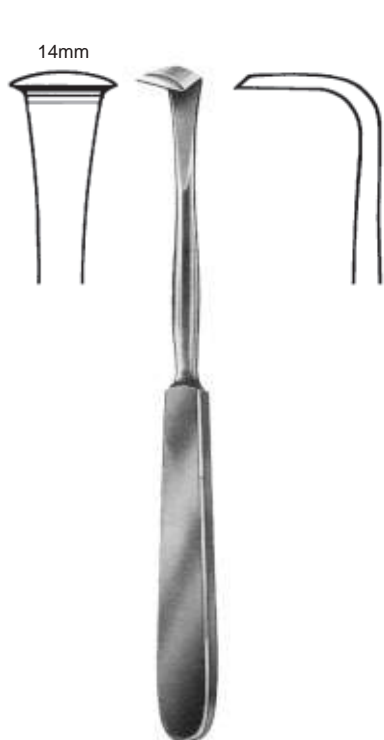

LANGENBECK
KN 401.18
 180mm / 7"

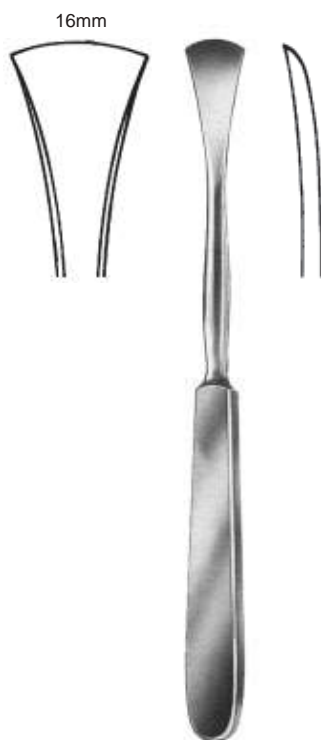

LANGENBECK
KN 402.19
 190mm / 7½"

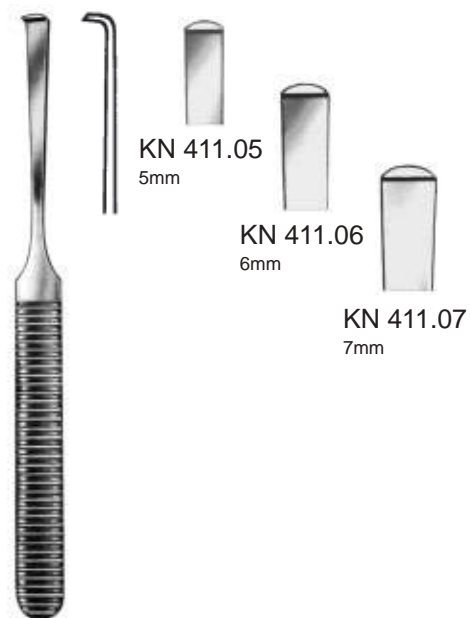

KN 411.05 - KN 411.07
 160mm / 6½"

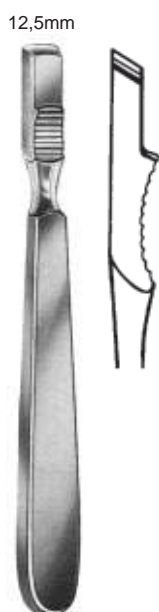

FARABEUF
KN 418.15
 150mm / 6"

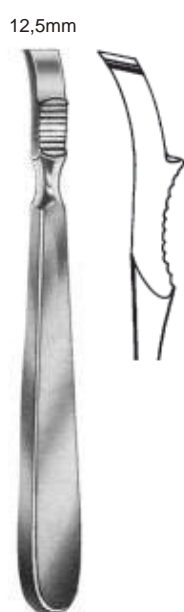

FARABEUF
KN 419.15
 150mm / 6"



FARABEUF - COLLIN
KN 420.16
 160mm / 6½"



FARABEUF - COLLIN
KN 421.16
 160mm / 6½"



SEDILLOT
KN 427.21
 210mm / 8¼"



KN 428.18
 180mm / 7"

KN 430.20
 200mm / 8"

KN 431.20
 200mm / 8"

KN 432.20
 200mm / 8"

Ferrozellgriff, Handle from artificial wood, Manico in "Ferrozell", Mango de madera artificial



KN 432.18
 180mm / 7"

KN 433.18
 180mm / 7"

KN 435.18
 180mm / 7"

KN 438.19
 190mm / 7½"

Ferrozellgriff, Handle from artificial wood, Manico in "Ferrozell", Mango de madera artificial



WILLIGER
KN 434.13
 130mm / 5"

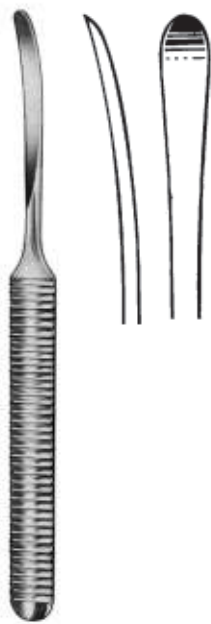

WILLIGER
KN 436.16
 160mm / 6 1/2"



6mm
 8mm
KN 439.06 **KN 439.08**

KN 439.06 - KN 439.08
 170mm / 6 3/4"



DOYEN
KN 441.17 - KN 447.17
 170mm / 6 1/4"



KN 441.17
KN 448.24



KN 443.17
KN 449.24



KN 445.17



KN 447.17



DOYEN
KN 448.24 - KN 449.24
 240mm / 9 1/2"

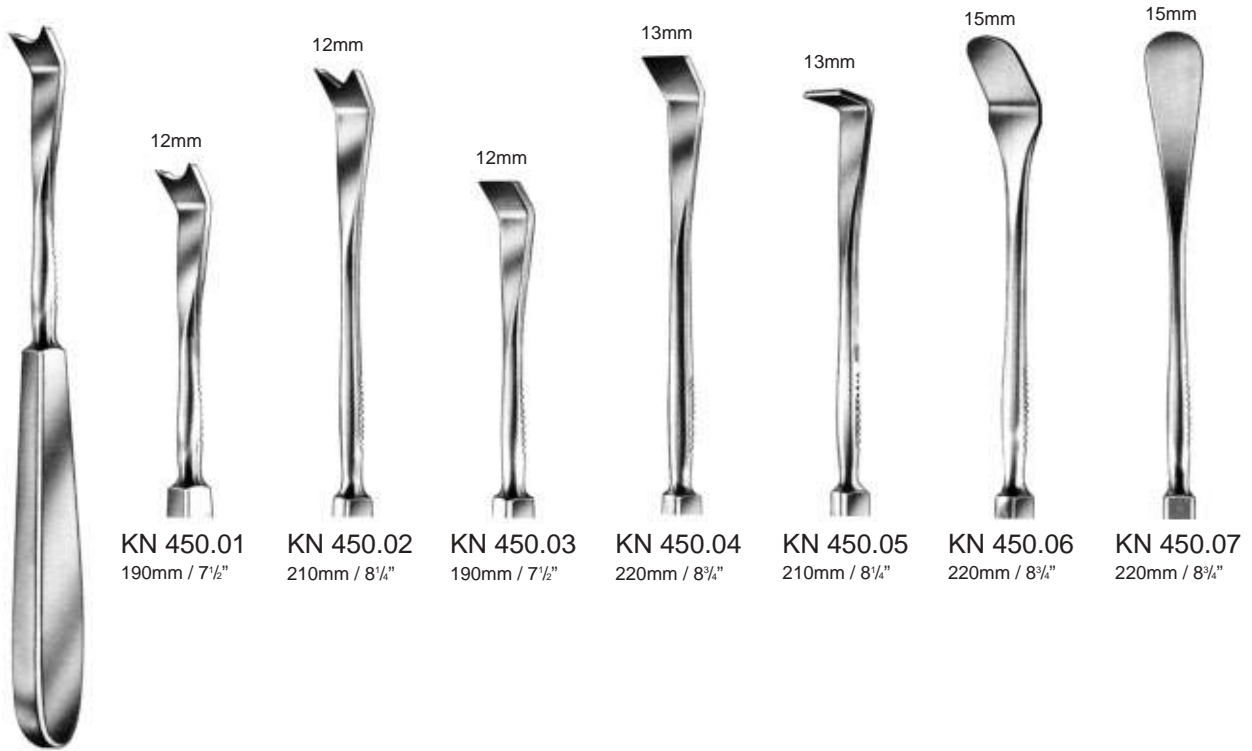

	12mm	12mm	12mm	13mm	13mm	15mm	15mm
KN 450.01	KN 450.02	KN 450.03	KN 450.04	KN 450.05	KN 450.06	KN 450.07	
190mm / 7½"	210mm / 8¼"	190mm / 7½"	220mm / 8¾"	210mm / 8¼"	220mm / 8¾"	220mm / 8¾"	

SEMB
 KN 450.01 - KN 450.07

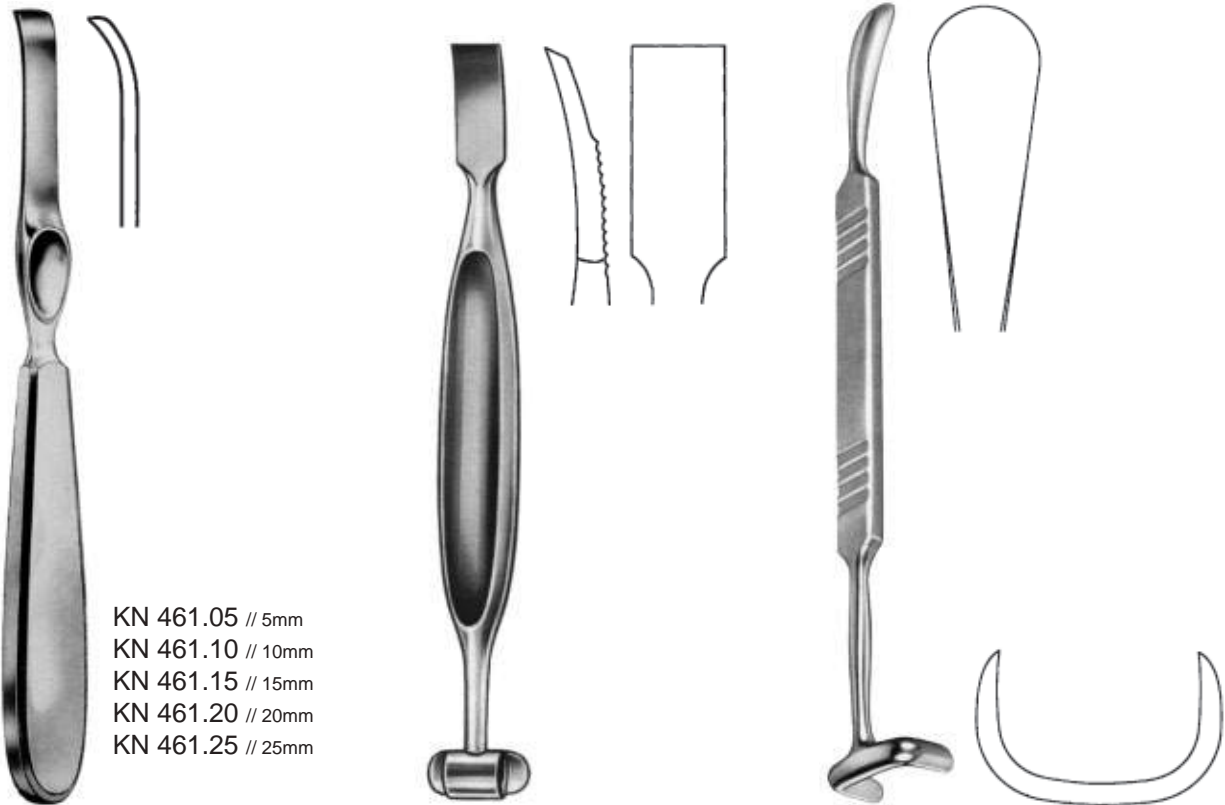

KN 461.05 // 5mm
 KN 461.10 // 10mm
 KN 461.15 // 15mm
 KN 461.20 // 20mm
 KN 461.25 // 25mm

LAMBOTTE
 KN 461.05 - KN 461.25
 210mm / 8¼"

ALEXANDER
 KN 467.20
 200mm / 8"

MATSON
 KN 469.22
 220mm / 8¾"

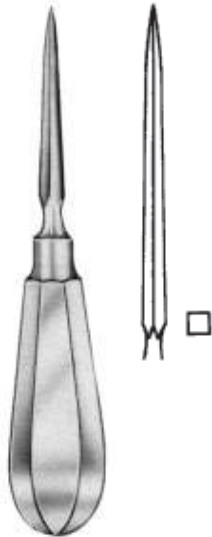

KO 130.14
140mm / 5½"



**PERTHES
KO 132.18**
180mm / 7"



**PERTHES
KO 134.21**
210mm / 8¼"

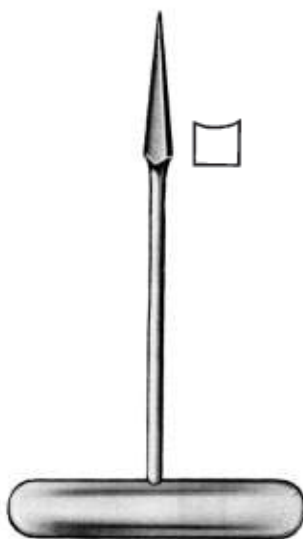

KO 136.14
140mm / 5½"



**ADSON
KC 139.15**
150mm / 6"

Bohrer-Führungs- und Dura Schutzzange,
Drill guide and dura protecting forcep,
Pinza-guida per perforatore e per proteggere la dura madre,
Pinza guía para perforar y proteger la dura-madre.



STILLE
KO 144.00
 200mm / 8"

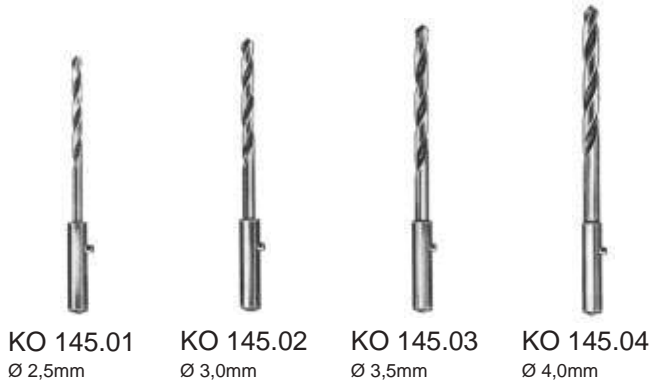

KO 145.01 Ø 2,5mm
 KO 145.02 Ø 3,0mm
 KO 145.03 Ø 3,5mm
 KO 145.04 Ø 4,0mm



KO 145.05 Ø 10,0mm
 KO 145.06 Ø 5,0mm
 KO 145.07 Ø 8,0mm
 KO 145.08 Ø 12,0mm
 KO 145.09 Ø 16,0mm



HUDSON
KO 152.00
 270mm / 10 1/2"



KO 152.01 Ø 9,0mm
 KO 152.02 Ø 14,0mm
 KO 152.03 Ø 16,0mm
 KO 152.04 Ø 22,0mm

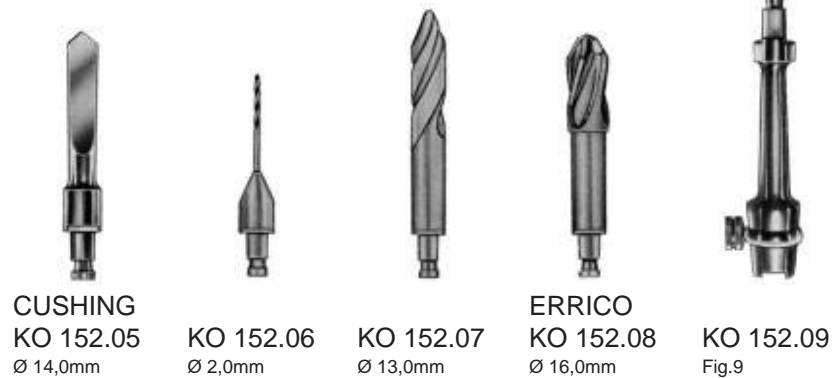

CUSHING
 KO 152.05 Ø 14,0mm
 KO 152.06 Ø 2,0mm
 KO 152.07 Ø 13,0mm
ERRICO
 KO 152.08 Ø 16,0mm
 KO 152.09 Fig.9

Einfacher Handbohrapparat mit Fräsern Fig. 1-4 und Verlängerungsstück Fig.9,
 Hand drill, with 4 burrs, fig.1-4 and extension piece fig.9,
 Perforatore a mano con 4 frese fig.1-4 e giunto di prolungamento fig.9,
 Perforador manual, con 4 fresas fig.1-4 y pieza alargadera fig.9



90mm 70mm
Ø 3,2mm Ø 3,2mm

KO 156.08

Satz, Set, Serie, Juego

1 Bohrer 90mm und 2 Bohrer 70mm,
1 drill 90mm and 2 drills 70mm,
1 punta 90mm e 2 punte 70mm,
1 taladro 90mm y 2 taladros 70mm

**MOORE
KO 156.00**

Handbohrapparat mit 3 Spiralbohrern,
Hand drill, with 3 drills,
Perforatore a mano con 3 punte a spirale,
Perforador manual, con 3 taladros espirales



KO 158.00

Handbohrapparat mit umstellbarem Handgriff, mit Jacobs Dreibacken-Spannfutter und Schlüssel, Spannweite bis 6,35mm,
Hand drill with adjustable handle, with Jacobs three-jaw-chuck and wrench, accomodating up to 6,35mm,
Perforatore a mano con manico regolabile, con mandrino a tre ganasce di Jacobs e chiave, apertura 6,35mm,
Perforador de mano en T con cierre Jacobs de 3 mordazas y llave de ajuste, abriendo hasta 6,35mm



**JACOBS
KO 158.06**

6,35mm

Vorbohrer für Crutchfield-Schädelhalter,
Drill points for Crutchfield cervical traction tongs,
Punte da perforazione iniziale per supporto craniale di Crutchfield,
Perforadores iniciales para pinzas de tracción craneal seg. Crutchfield

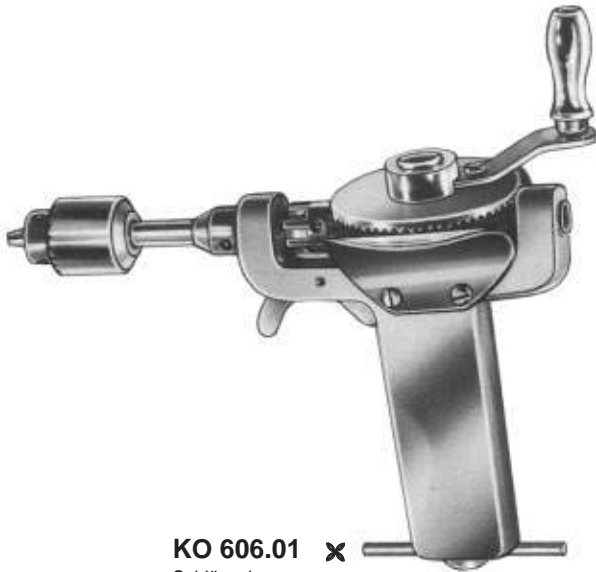

KO 606.01 ✕
Schlüssel,
Wrench,
Chiave,
Llave

**BUNNELL
KO 606.00**

Bohrapparat, 16cm, längsdurchbohrt mit Dreibackten-Spannfutter und Schlüssel bis \varnothing 4mm,
Hand drill, 16cm, longitudinally bored, with three-jaw-chuck and key, opening up to \varnothing 4mm,
Perforatore a mano, 16cm, con perforazione assiale, con mandrino a tre ganasce e chiave, apertura fino a \varnothing 4mm,
Perforador manual, 16cm, taladrado longitudinalmente, con mandril de tres mordazas y llave, abriendo hasta de \varnothing 4mm



**RALK
KO 611.01**

Bohrapparat mit Leichtmetallgehäuse und seitlich abgewinkeltem Griff, mit Dreibackten-Spannfutter und Schlüssel. Spannweite bis \varnothing 6,35mm,
Hand drill with light metal case and laterally angled handle, with three-jaw-chuck and key, opening up \varnothing 6,35mm,
Perforatore a mano con cassa in metallo leggero e manico angolato lateralmente, con mandrino a tre ganasce e chiave, apertura fino a \varnothing 6,35mm,
Perforador manual con caja de aluminio y mango angulado hacia un lado, con mandril de tres mordazas y llave, abriendo hasta de \varnothing 6,35mm



KO 620.01

Handgriff mit Dreibackten-Spannfutter, Spannweite bis 6,35mm und durchgehenden Bohrkanal zum Einschlagen und extrahieren von Nägeln, Führungsspießen und Bohrdrähten.
Handle with chuck and key, accomodating up to 6,35mm, perforated, for inserting and extracting nails, guide pins, and wire guide drills.
Manico con mandrino a tre ganasce, apertura fino a 6,35mm con perforazione assiale, per inserzione ed estrazione di chiodi, spiedi di guida e perforatori filiformi.
Mango con mandril, abriendo hasta 6,35mm, perforado para insertar y extraer clavos, clavos de guía y taladros filiformes.



CHARRIÈRE
KV 101.35
350mm / 13³/₄"



KV 101.92 // 12mm
KV 101.95 // 15mm
Ersatzsägeblätter,
Spare saw blades,
Lame di ricambio per sega,
Hojas de sierra de repuesto



LANGENBECK
KV 110.23
230mm / 9"



CHARRIÈRE
KV 112.27
270mm / 10¹/₂"



SATTERLEE
KV 114.31
310mm / 12¹/₄"

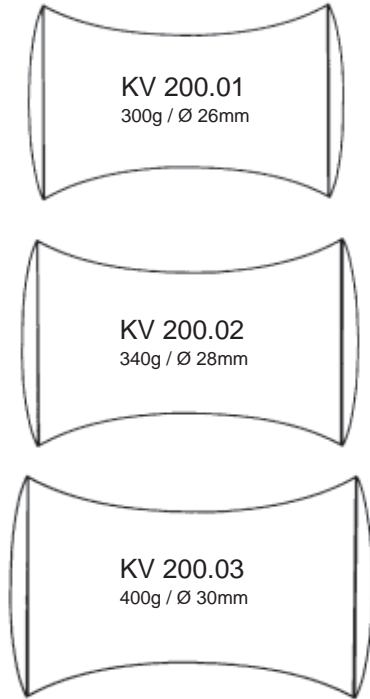

WILLIGER
KV 200.01 - KV 200.03
240mm / 9½"

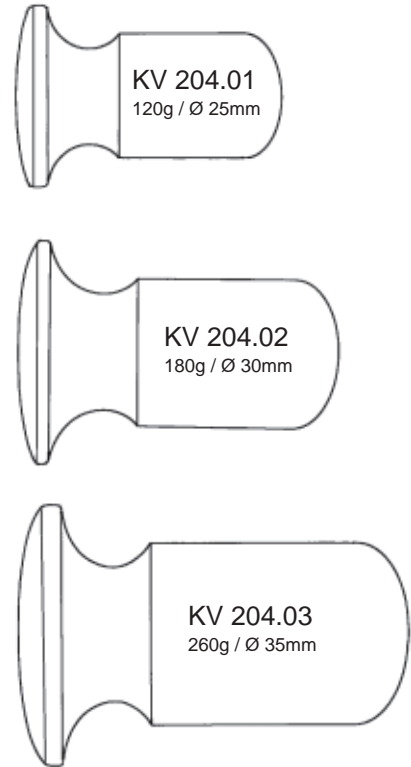

DOYEN
KV 204.01 - KV 204.03
210mm / 8¼"



220g / Ø 30mm

COLLIN
KV 208.20
200mm / 8"

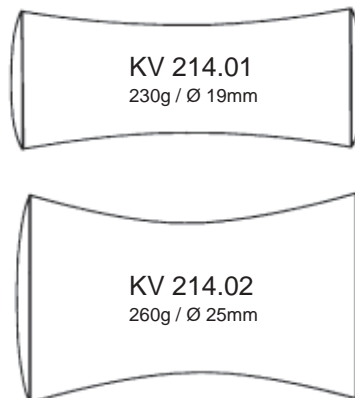

LUCAE
KV 214.01- KV 214.02
190mm / 7½"



140g / Ø 20mm

KV 216.01
160mm / 6½"



KV 218.22
260mm / 10 $\frac{1}{4}$ "



COTTLE
KV 234.19
190mm / 7 $\frac{1}{2}$ "

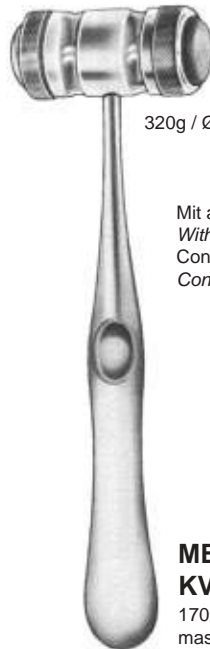

MEAD
KV 220.17
170mm / 6 $\frac{3}{4}$ "
massiv, solid, massiccio, macizo



KV 236.01
260mm / 10 $\frac{1}{4}$ "
Ferrozell, bleigefüllt,
Ferrozell, lead filled,
Ferrozell, riempito di piombo,
Ferrozell, rlleno de plomo

KV 236.02
260mm / 10 $\frac{1}{4}$ "
Ferrozell, ohne Blei,
Ferrozell, without lead ,
Ferrozell, senza piombo,
Ferrozell, sin plomo

KV 221.00
Ersatzbackenpaar,
Spare jaws, pair,
Placche di ricambio, paia,
Tapas de repuesto, par

320g / Ø 26mm

Mit auswechselbaren Ferrozellbacken,
With interchangeable Ferrozell jaws,
Con placche intercambiabili in Ferrozell,
Con tapas intercambiales de Ferrozell



200g / Ø 22mm

PARTSCH
KV 224.18
180mm / 7"



250g / Ø 42mm



Ferrozell, bleigefüllt,
Ferrozell, lead filled,
Ferrozell, riempito di piombo,
Ferrozell, rlleno de plomo

KV 238.26
260mm / 10¹/₄"



rückschlagfrei,
repercussion free,
senza ripercussione,
sin repercusión

KV 240.29
260mm / 10¹/₄"



Ø 30mm

530g / Ø 42mm

KV 242.24
260mm / 10¹/₄"

Stahl massiv, mit Kunststoffstiel,
Steel solid, with plastic handle,
Acciaio massiccio, con manico in plastica,
Acero macizo, con mango de materia plástica

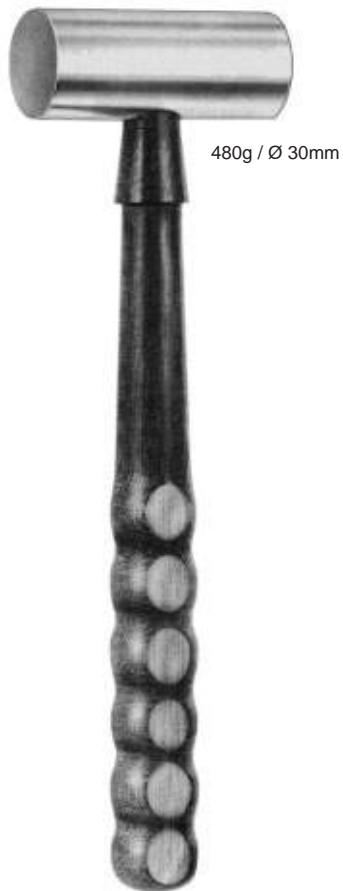

480g / Ø 30mm

KV 244.24
240mm / 9½"

Stahl massiv, mit Ferrozellstiel,
Steel solid, with Ferrozell handle,
Acciaio massiccio, con manico in Ferrozell,
Acero macizo, con mango de Ferrozell

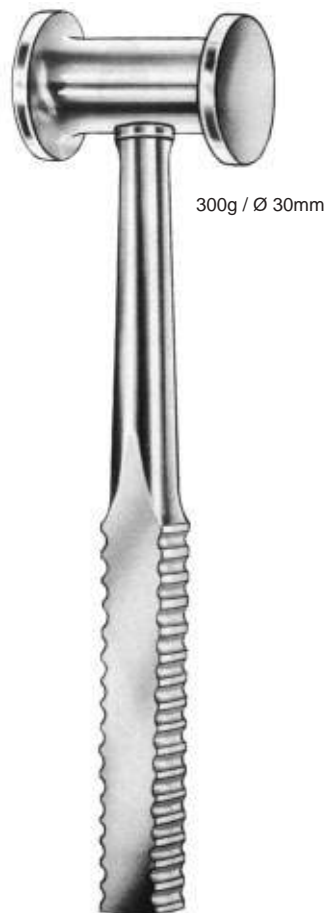

300g / Ø 30mm

BERGMANN
KV 246.24
240mm / 9½"



KV 255.00
Ersatzbacken, paar,
Spare jaws, pair,
Placche di ricambio, paia,
Tapas de repuesto, par

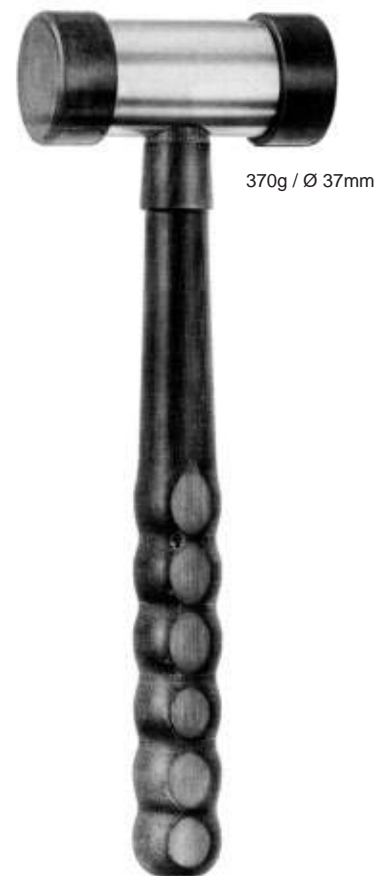

370g / Ø 37mm

KV 254.22
220mm / 8¾"

Stahl massiv, mit Ferrozellbacken,
Steel solid, with Ferrozell jaws,
Acciaio massiccio, con placche in Ferrozell,
Acero macizo, con tapas de Ferrozell



125g / Ø 30mm

Ferrozell massiv,
Ferrozell solid,
Ferrozell massiccio,
Ferrozell, macizo

KV 256.18
180mm / 7"

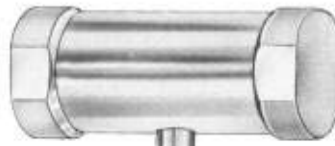

KV 258.10 // 100g
KV 258.35 // 350g
KV 258.50 // 500g
KV 258.70 // 700g
220mm / 8¾"



450g

Stahl massiv,
Steel solid,
Acciaio massiccio,
Acero, macizo

KV 260.01
260mm / 10¼"



900g

Stahl massiv,
Steel solid,
Acciaio massiccio,
Acero, macizo

KV 260.02
260mm / 10¼"



550g / Ø 40mm

OMBREDANNE
KV 261.24
240mm / 9½"



mit auswechselbaren Kunststoffbacken,
with interchangeable plastic jaws,
con placche intercambiabili in plastica,
con tapas intercambiables de plástico

VICKERS
KV 262.19
190mm / 7½"



KV 368.25
250mm / 10"



KV 368.35
250mm / 10"



KV 372.17
170mm / 6 7/8"



LANE
KV 374.25
250mm / 10"



KV 378.25
250mm / 10"



PHILIPS
KV 380.25
250mm / 10"

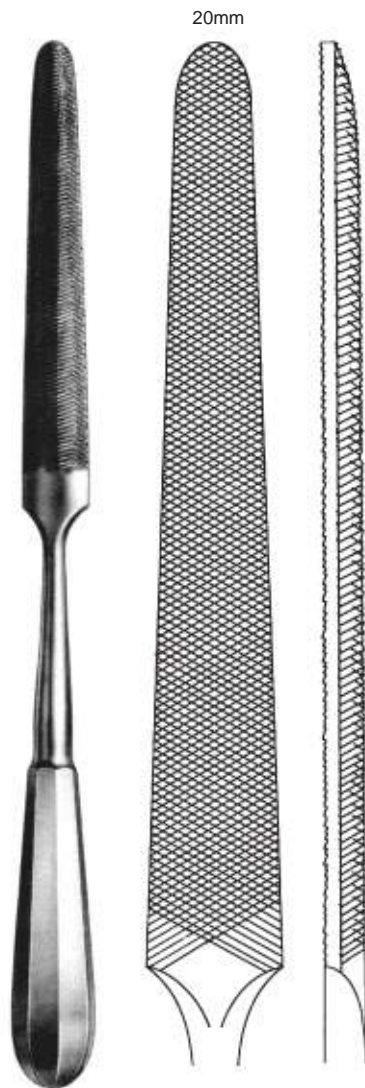

KV 480.28
280mm / 11"

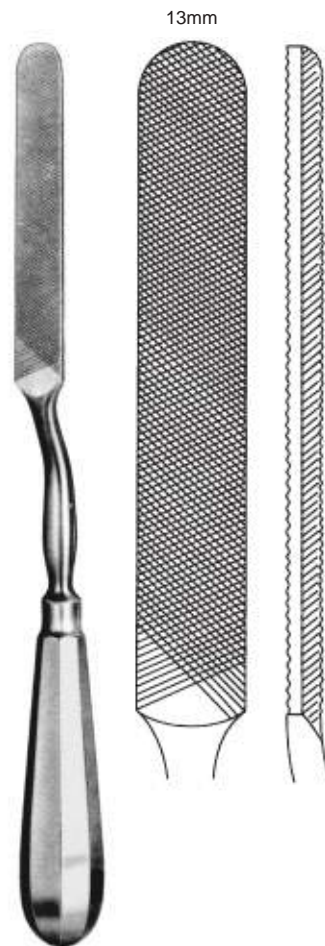

KV 481.24
240mm / 9½"



KV 482.22
220mm / 8¾"



DEMEL
KV 535.01 - KV 535.03

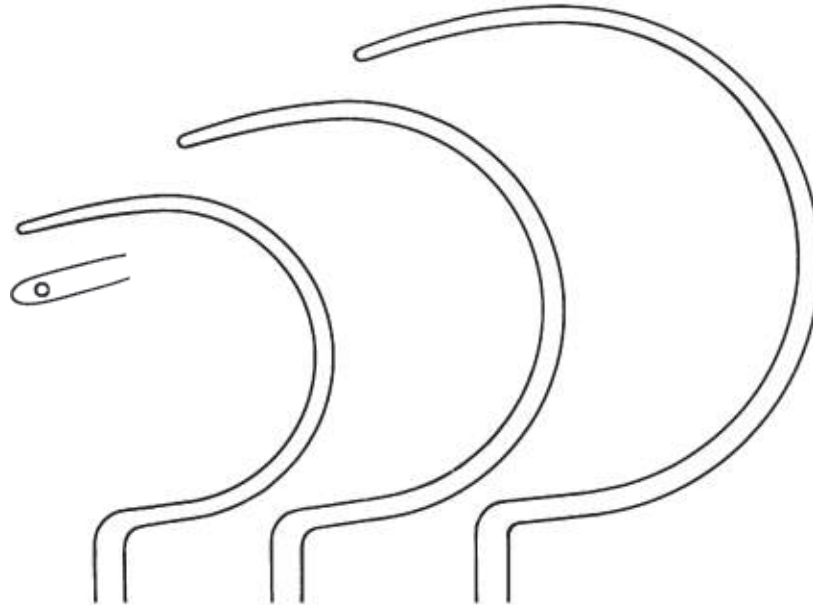

KV 535.01
Fig. 1

KV 535.02
Fig. 2

KV 535.03
Fig. 3



LOUTE
KV 542.21
210mm / 8 1/4"

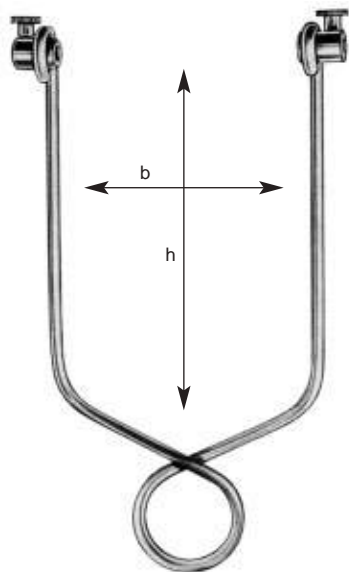

BÖHLER
KV 565.16 - KV 565.21

KV 565.16
 h 16 x b 9 cm
 für Arm, *for arm,*
 per braccio, *para brazo*

KV 565.21
 h 21 x b 11 cm
 für Oberschenkel und Knie,
for thigh and knee,
 per femore e ginocchio,
para femur y rodilla



mit 3 Zughaken,
with 3 traction hooks,
 con 3 ganchi di trazione,
con 3 ganchos de tracción

KIRSCHNER
KV 581.01 - KV 581.05

lichte Weite
clear width
 larghezza interna
anchura interior

	cm	in.
KV 581.01	9,5 x 7	3 ¹ / ₄ x 2 ³ / ₄
KV 581.02	10,5 x 10,5	4 ¹ / ₄ x 4 ¹ / ₄
KV 581.03	12 x 12	4 ³ / ₄ x 4 ³ / ₄
KV 581.04	15,5 x 15,5	6 x 6
KV 581.05	20 x 15,5	8 x 6

mit 3 Zughaken,
with 3 traction hooks,
 con 3 ganchi di trazione,
con 3 ganchos de tracción



KIRSCHNER
KV 585.01 - KV 585.02

KV 585.01
 180mm / 7" // 0 - 40mm

KV 585.02
 270mm / 10¹/₂" // 35 - 200mm

Spannschlüssel,
Wire strainer,
 Chiave con morso di fissaggio, per tendere il filo,
Tensor de taladros



KV 586.18



KV 587.19

Mutterschlüssel,
Srew nut wrench,
 Chiave per madreviti,
Llave de tuercas



KV 588.12

Schraubendreher,
Srew driver,
 Cacciavite,
Artonillador



	lichte Weite clear width larghezza interna anchura interior	cm	in.
KV 589.18		18 x 10	7 x 4
KV 589.27		27 x 16	10½ x 6¼

KV 589.18 - KV 589.27

Fixierscheiben für Bohrdrähte,
Fixation discs for drill wires,
 Dischi fissatori per i perforatori filiformi,
Discos fijadores para taladros filiformes



KV 601.02
 paar, pair, paio, par

Zughaken allein,
Traction hook only,
 Gancio per trazione solo,
Gancho para tracción suelto



KV 603.03





Zughaken allein,
Traction hook only,
 Gancio per trazione solo,
Gancho para tracción suelto



KV 603.06

Sehnenstripper, Durchzugsinstrumente
Tendon Stripper, Tendon Tunnel Instruments
Scollatendini, Strumenti per guaina tendinea
Instrumentos para coger tendones y para el tunel del tendón





-  KV 652.01
-  KV 652.02
-  KV 652.03
-  KV 652.04
-  KV 652.05

Sehenschäler,
Tendon stripper,
 Enucleatore di tendine,
Enucleadores de tendones

BUNNELL
KV 652.01 - KV 652.05
 150mm / 6"



Schaft biegsam,
Flexible shaft,
 Asta flessibile,
Vástago flexible

-  KV 654.40
4mm
-  KV 654.45
4,5mm
-  KV 654.55
5,5mm

Sehnenstripper,
Tendon strippers,
 Scollatendini,
Enucleadores de tendones

BUNNELL
KV 654.40 - KV 654.55
 230mm / 9"

Ø 7mm



KV 656.01

Schraube allein,
Spare screw,
 Vite di ricambio solo,
Tornillo de repuesto



Sehnenführer,
Tendon passing instrument,
 Guida per tendine,
Instrumento para el tunel del tendón

KV 656.00
 340mm / 13½"



FISCHER
KV 660.31
310mm / 12¹/₄"



KV 662.29
290mm / 11¹/₄"

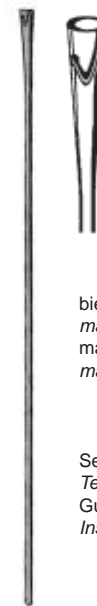

biegsam,
malleable,
malleabile,
malleables

Sehnenführer,
Tendon passing instrument,
Guida per tendine,
Instrumento para el tunel del tendón

BUNNELL
KV 664.18 // 180mm / 7"
KV 664.23 // 230mm / 9"

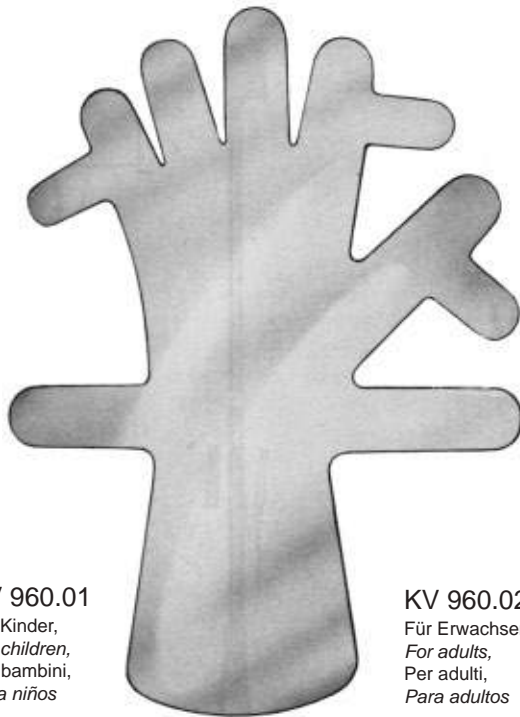

KV 960.01
Für Kinder,
For children,
Per bambini,
Para niños

KV 960.02
Für Erwachsene,
For adults,
Per adulti,
Para adultos

KV 960.01 - KV 960.02



FELDHEIM
KV 964.10
100mm / 4 1/4"

Fingernagelbohrer, *Finger nail drill,*
Perforatore per unghie, *Perforadores para uñas*



KV 967.10
100mm / 4 1/4"



KV 968.01



KV 968.02



KV 968.03

KV 968.00
Satz, Set, Serie, Juego

Instrumente für Finger- und Zehnnägel, Fingerringsägen
Nail Instruments, Finger Ring Saws
 Strumenti per unghie, Seghe per anelli
Instrumental para uñas, Sierras para abrir anillos

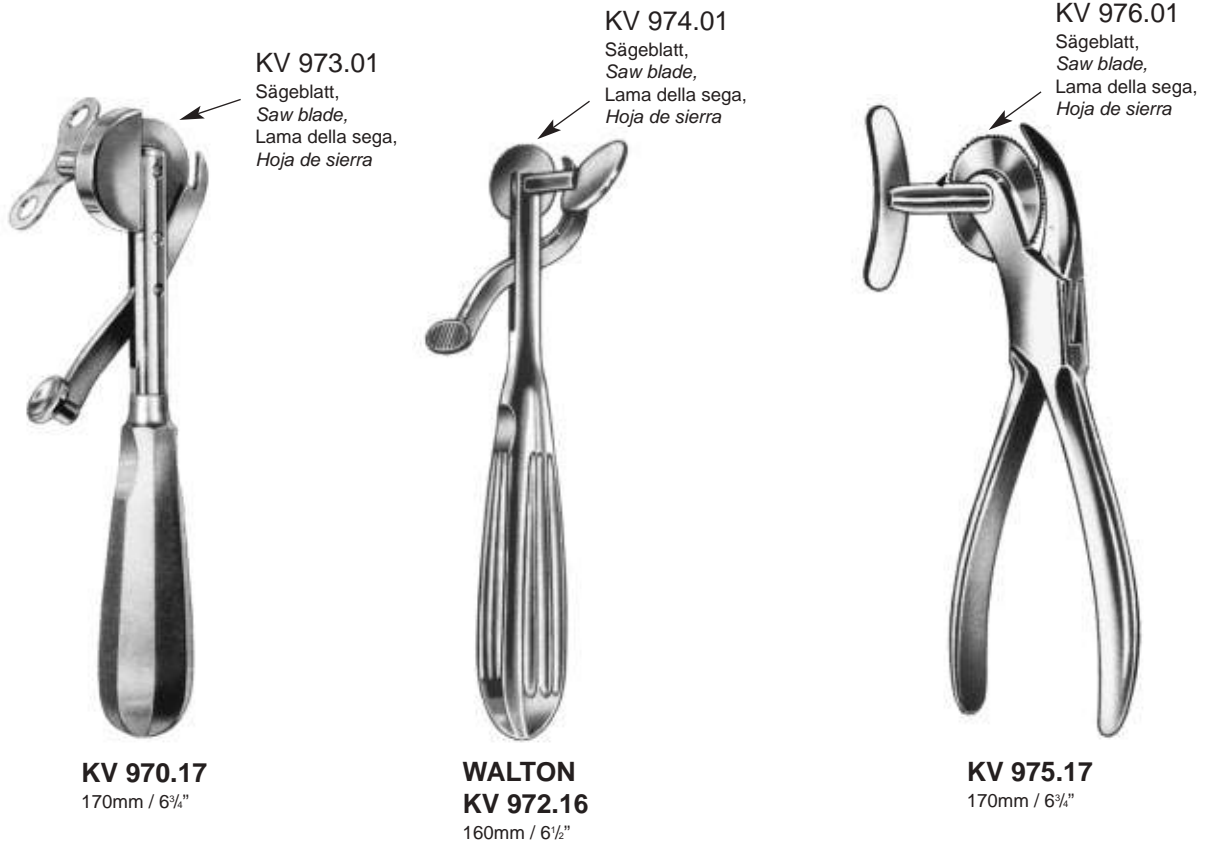

KV 973.01
Sägeblatt,
Saw blade,
Lama della sega,
Hoja de sierra

KV 974.01
Sägeblatt,
Saw blade,
Lama della sega,
Hoja de sierra

KV 976.01
Sägeblatt,
Saw blade,
Lama della sega,
Hoja de sierra







DARM, MAGEN, MASTDARM
INTESTINES, STOMACH, RECTUM
INTESTINO, STOMACO, RETTO
INTESTINOS, ESTÓMAGO, RECTO

Darmklemmen
Intestinal Clamp Forceps
Pinze intestinali
Pinzas-clamps intestinales



DOYEN
PC 274.21 - PC 275.23



PC 274.21
 210mm / 8¹/₄"

PC 274.23
 230mm / 9"

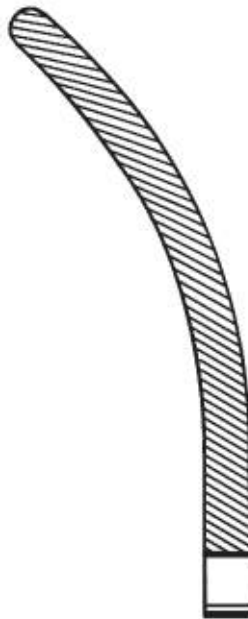

PC 275.21
 210mm / 8¹/₄"

PC 275.23
 230mm / 9"

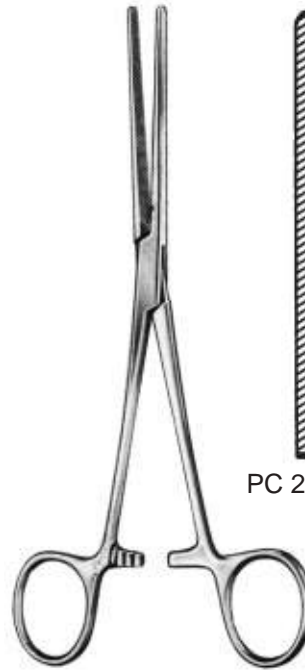

BABY - DOYEN
PC 276.18 - PC 277.18
 180mm / 7"



PC 276.18

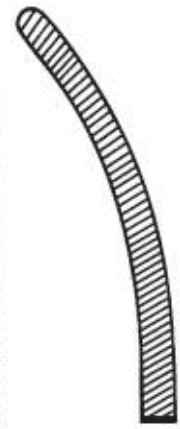

PC 277.18



MAYO - ROBSON
PC 286.21 - PC 289.25



PC 286.21
 210mm / 8¹/₄"

PC 286.23
 230mm / 9"



PC 287.21
 210mm / 8¹/₄"

PC 287.23
 230mm / 9"



PC 288.25
 250mm / 10"

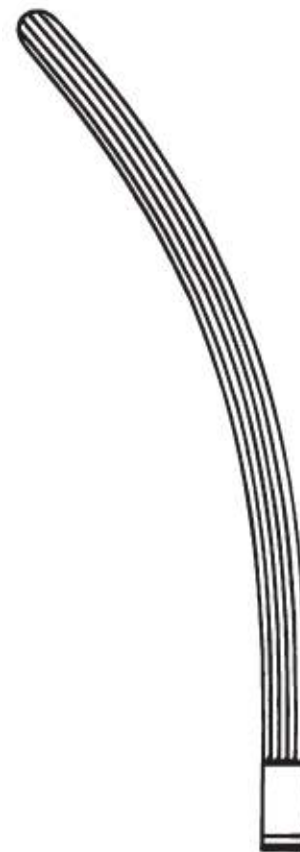

PC 289.25
 250mm / 10"

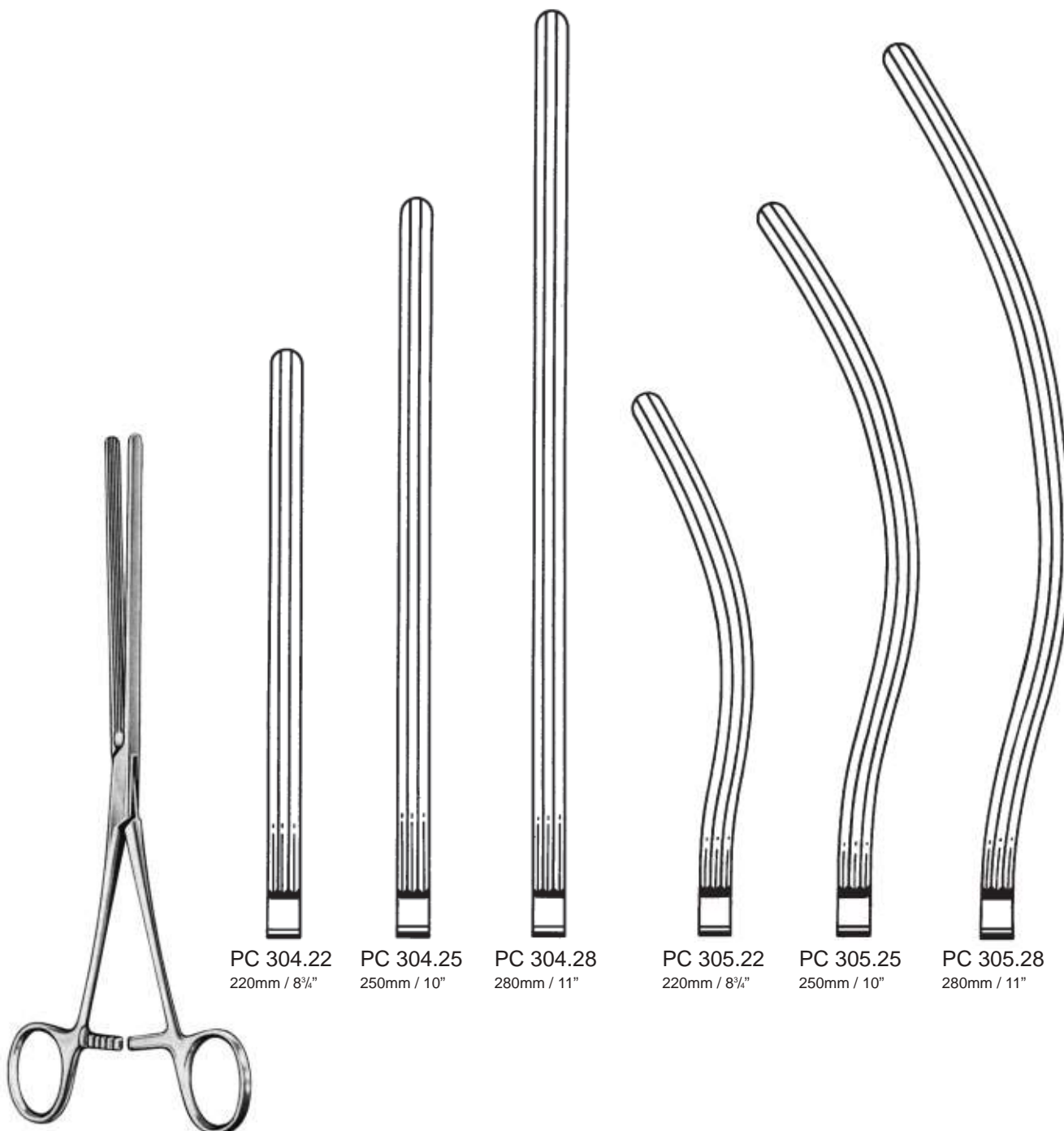

PC 304.22
220mm / 8³/₄"

PC 304.25
250mm / 10"

PC 304.28
280mm / 11"

PC 305.22
220mm / 8³/₄"

PC 305.25
250mm / 10"

PC 305.28
280mm / 11"

KOCHER
PC 304.22 - PC 305.28

Darm- und Magenquetschklemmen
Intestinal and Stomach Clamp (Crushing Clamps)
 Pinze e schiacciatori per l'intestino e stomaco
Pinzas-clamps intestinales y estomacales

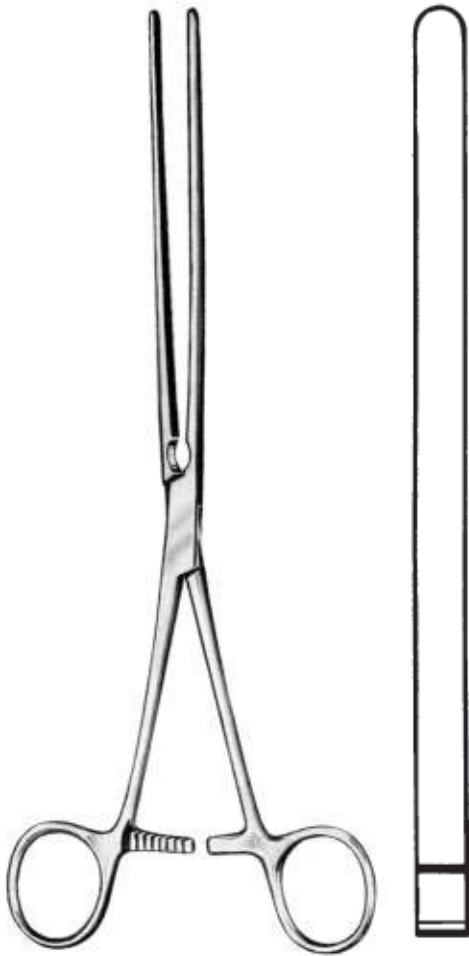

SCUDDER
PC 352.25
 250mm / 10"



PAYR - BABY
PC 415.15
 150mm / 6"

mit Stift, with pin,
 con perno, con espiga



PAYR
PC 419.21 - PC 433.35

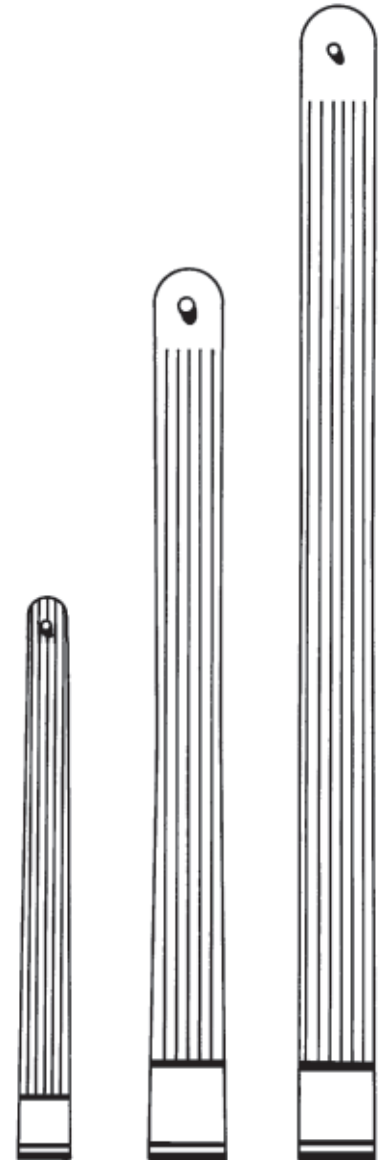

PC 419.21 **PC 425.29** **PC 433.35**
 210mm / 8¹/₄" 290mm / 11¹/₄" 350mm / 13³/₄"

mit Stift, with pin, con perno, con espiga

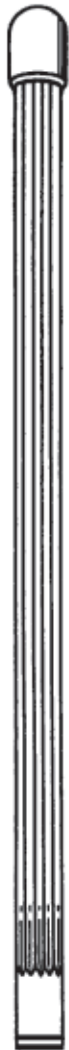

PC 464.30

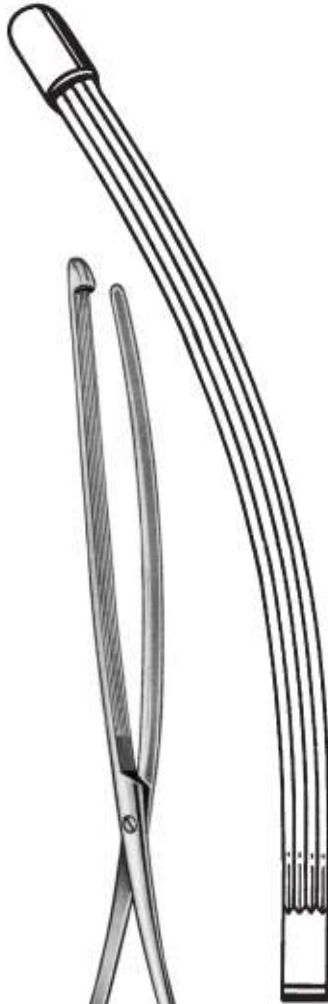

PC 465.30

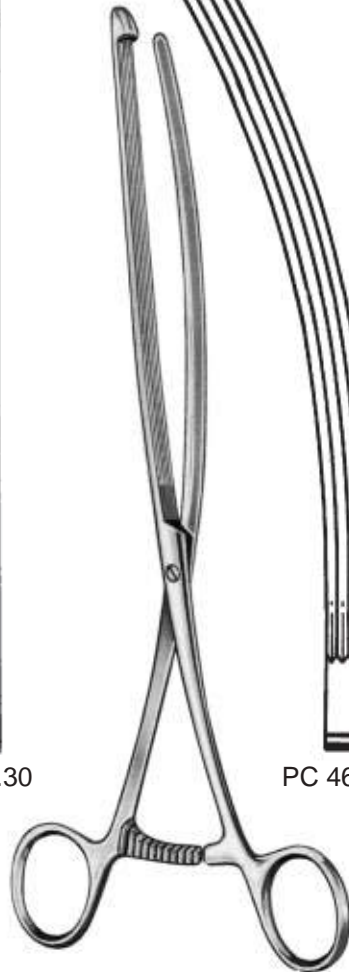

NUSSBAUM
PC 464.30 - PC 465.30
300mm / 12"



PC 474.30

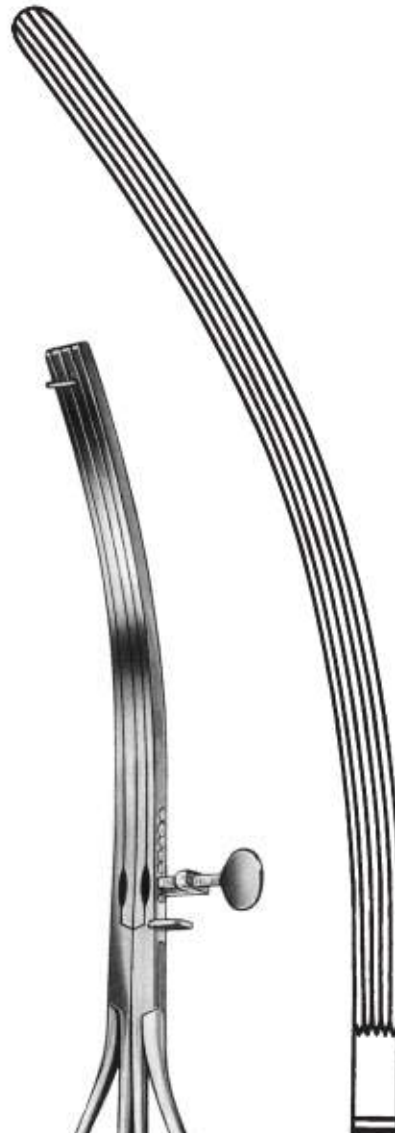

PC 475.30

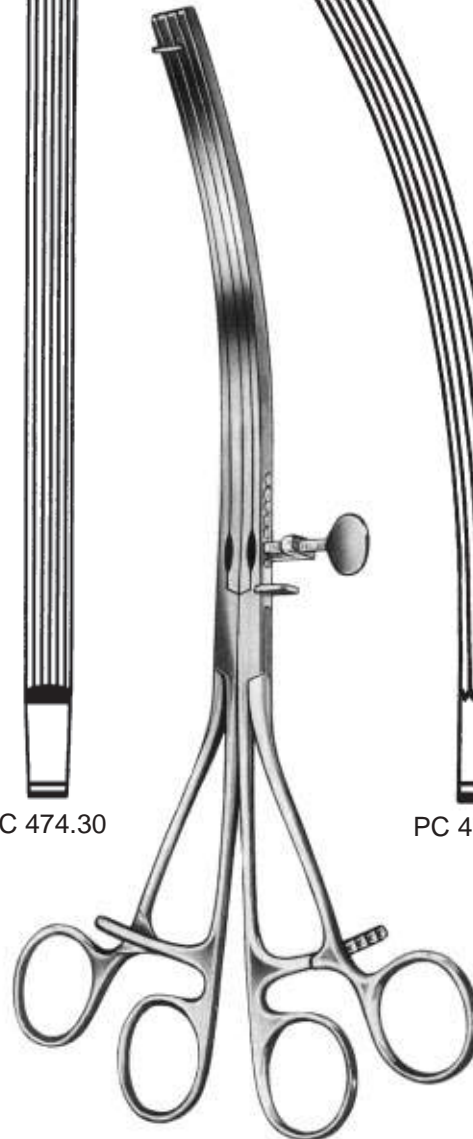

LANE
PC 474.30 - PC 475.30
300mm / 12"



Darmklemmen, Anastomosenklemmen
Intestinal and Anastomosis Clamp Forceps
Pinze intestinali e per anastomosi
Pinzas-clamps intestinales y para anastomosis



DE MARTEL - WOLFSON
PC 496.05 - PC 496.10

Satz zu 3 Klemmen,
 Set of 3 clamps,
 Serie di 3 pinze,
 Juego de 3 clamps



PC 496.05
 50mm / 2"



PC 496.07
 70mm / 2¾"



PC 496.10
 100mm / 4¼"



Klemmschließzange,
 Clamp closing forceps,
 Serrapinze,
 Pinza para cerrar clamps

DE MARTEL - WOLFSON
PC 497.20
 200mm / 8"



PC 498.08
 80mm / 3¼"



DE MARTEL - WOLFSON
PC 498.23
 230mm / 9"



STONE - WATT
PC 520.07 // 70mm / 2¾"
PC 520.10 // 100mm / 4¼"



STONE - WATT
PC 522.00



STONE
PC 524.15
 150mm / 6"

ATRAUMATIC



DOYEN - ATRAUMATIC
 PC 550.13 - PC 551.23

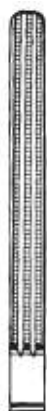

PC 550.13
 130mm / 5"



PC 550.16
 160mm / 6½"



PC 550.18
 180mm / 7"

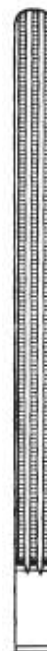

PC 550.21
 210mm / 8¼"



PC 550.23
 230mm / 9"



PC 551.13
 130mm / 5"



PC 551.16
 160mm / 6½"



PC 551.18
 180mm / 7"

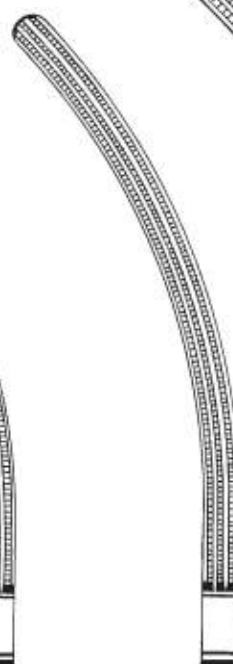

PC 551.21
 210mm / 8¼"

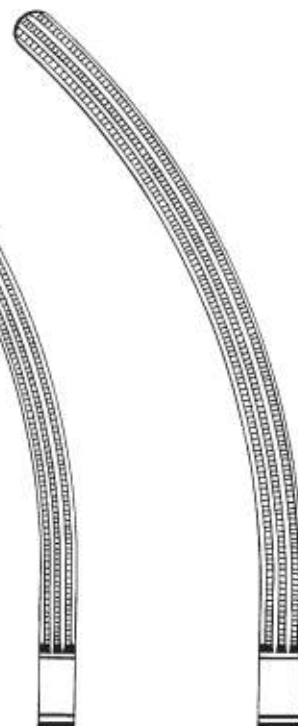

PC 551.23
 230mm / 9"

ATRAUMATIC



MAYO - ROBSON
PC 554.25 - PC 555.25
250mm / 10"

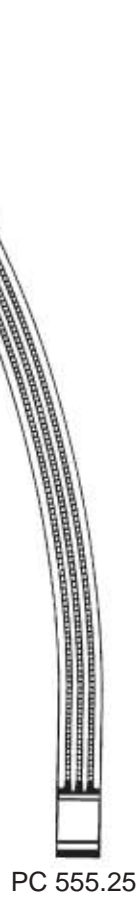

KOCHER
PC 560.22 - PC 560.28



220mm / 8 1/2"

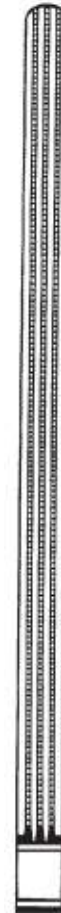

250mm / 10"

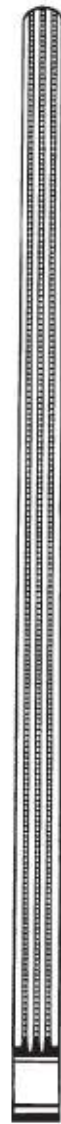

280mm / 11"

ATRAUMATIC



KOCHER
PC 561.22 - PC 561.28

PC 561.22
220mm / 8³/₄"

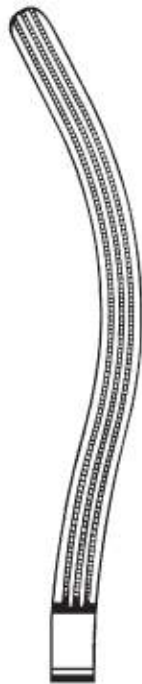

PC 561.25
250mm / 10"

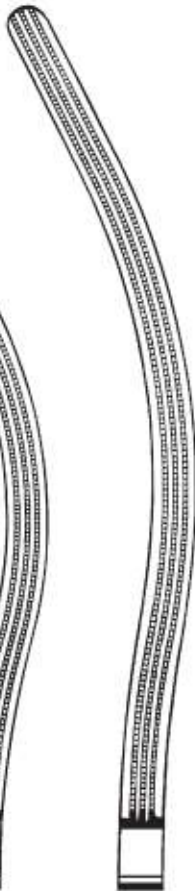

PC 561.28
280mm / 11"



PC 570.33



SCUDDER
PC 570.33 - PC 571.33
330mm / 13"

PC 571.33

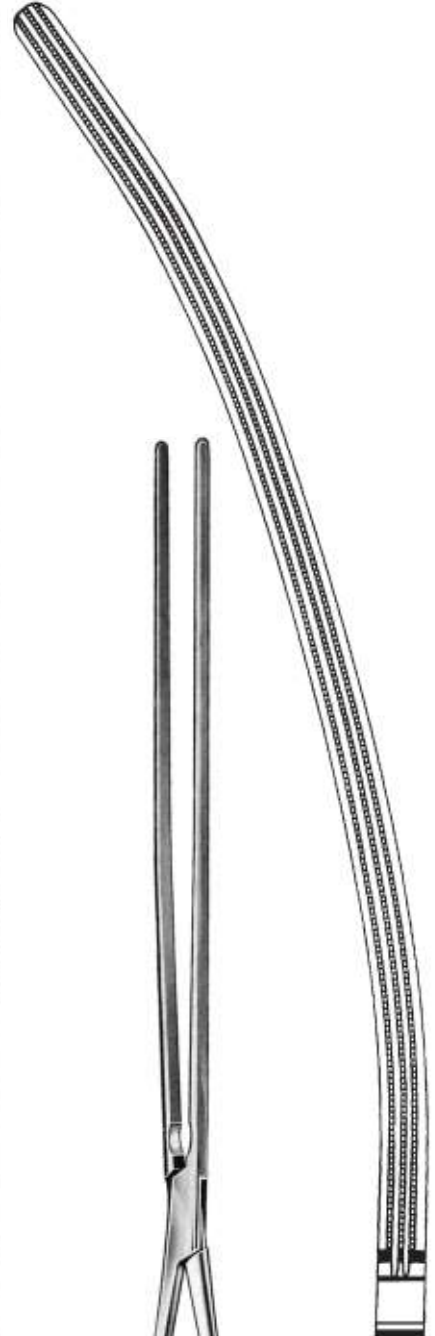

ATRAUMATIC

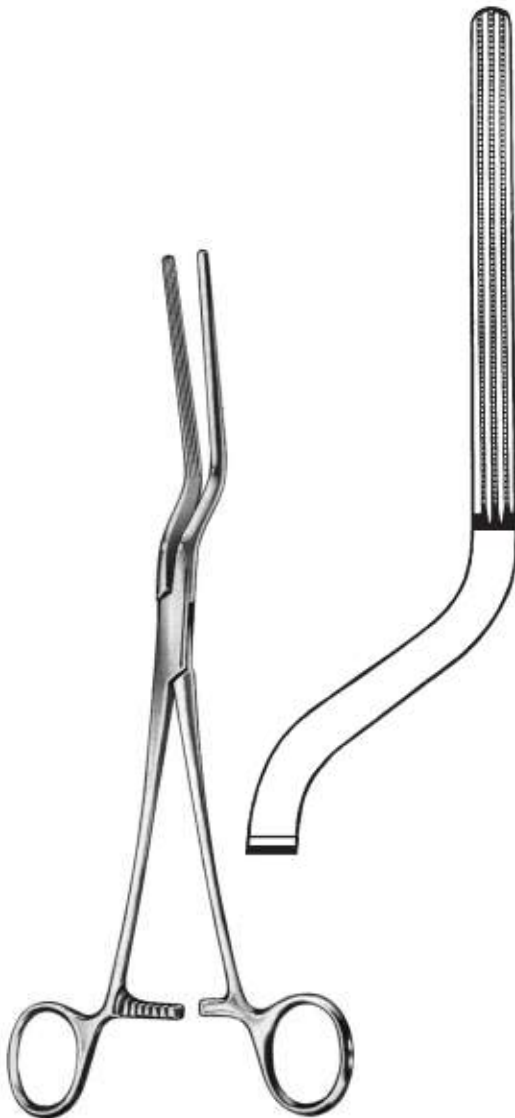

BRUNNER
PC 580.24
240mm / 9½"



PC 581.28
280mm / 11"

PC 581.26
260mm / 10¼"

Zur Mastdarmresektion,
Low-anterior rectum resection,
Per anastomosi del retto,
Para anastomosis del recto



HAYES
PC 581.26 - PC 581.28

ATRAUMATIC



VEIDENHEIMER
PC 583.23
230mm / 9"



FEHLAND
PC 585.24
240mm / 9½"



RESANO
PC 587.30
300mm / 12"

Mastdarm - Biopsiezangen
Rectal Biopsy Specimen Forceps
Pinze taglienti per biopsia rettale
Pinzas (sacabocado) para biopsia rectal



Schaftlänge, Length of shaft, Lunghezza dell'asta, Longitud de vástago

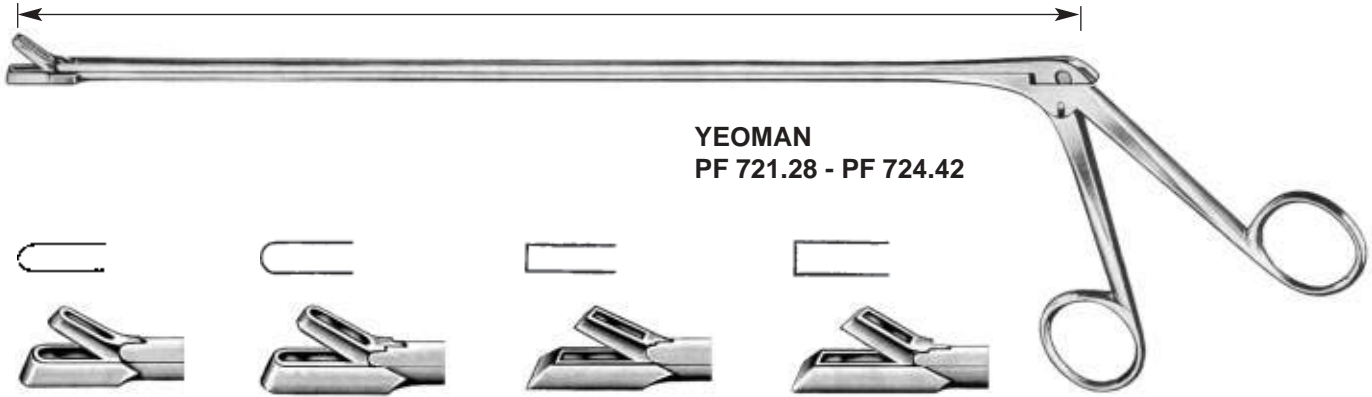

YEOMAN
PF 721.28 - PF 724.42

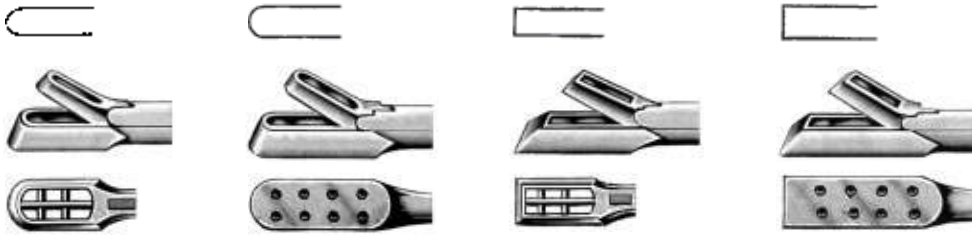

PF 721.28
PF 721.35
PF 721.42

PF 722.28
PF 722.35
PF 722.42

PF 723.28
PF 723.35
PF 723.42

PF 724.28
PF 724.35
PF 724.42

mm / in.
 280mm / 11"
 350mm / 13³/₄"
 420mm / 16¹/₂"

Schaftlänge, Length of shaft, Lunghezza dell'asta, Longitud de vástago

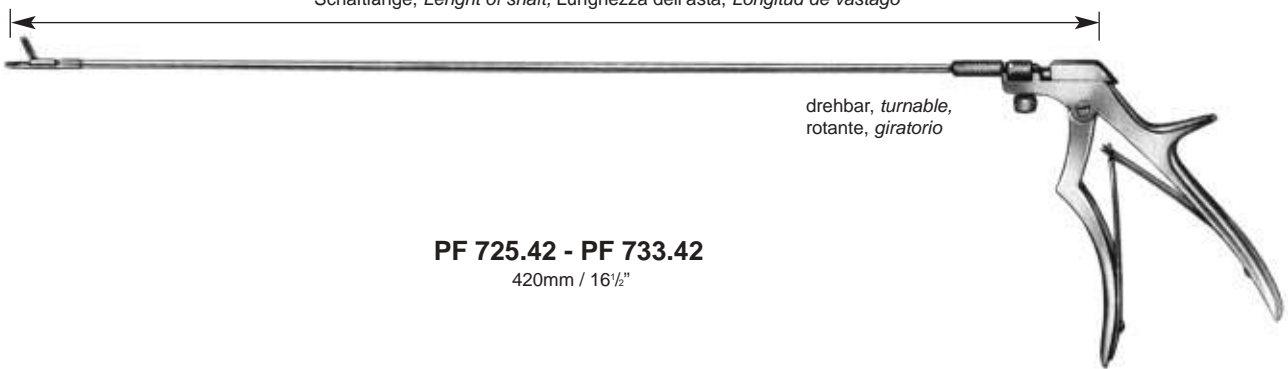

PF 725.42 - PF 733.42
 420mm / 16¹/₂"



PF 725.42



PF 727.42



PF 729.42



PF 731.42



PF 733.42

PF 725.00
 Griff allein, Handle only,
 Manico solo, Mango suelto

Mastdarm - Biopsiezangen, Hämorrhoidalzangen
Rectal Biopsy Specimen Forceps, Haemorrhoidal Forceps
Pinze taglienti per biopsia rettale, Pinze per emorroidi
Pinzas (sacabocado) para biopsia rectal, Pinzas hemorroidales

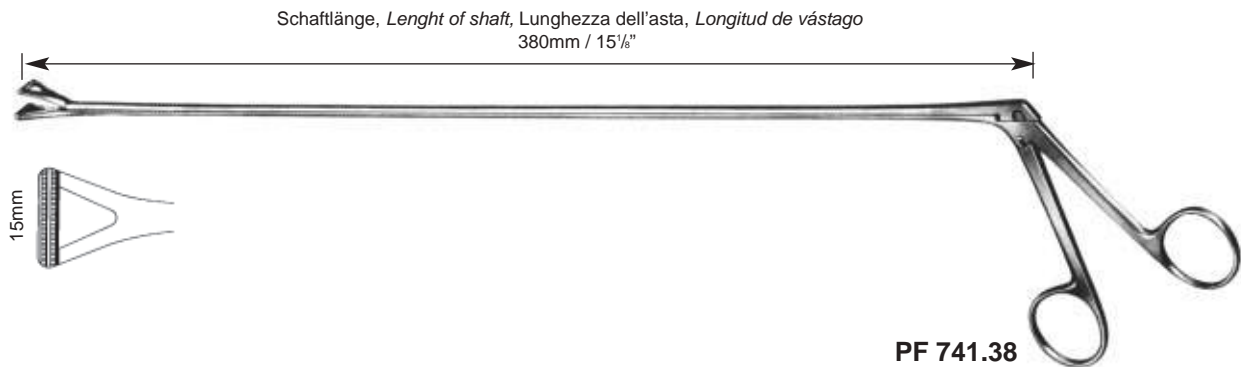

Hämorrhoidalklemme,
 Haemorrhoidal clamp,
 Pinza emorroidale,
 Pinza hemorroidal

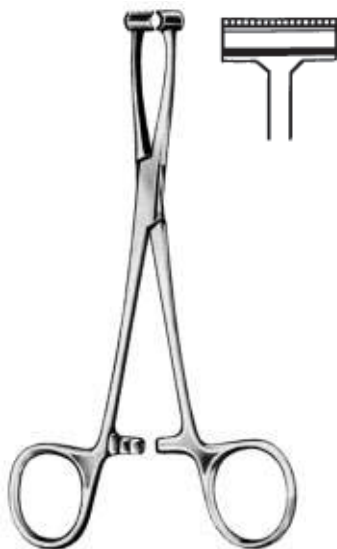

PRATT
PF 282.15
 150mm / 6"

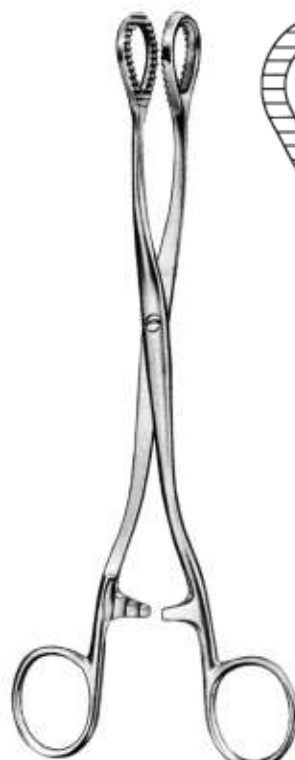

HEYWOOD - SMITH
PF 756.20
 200mm / 8"

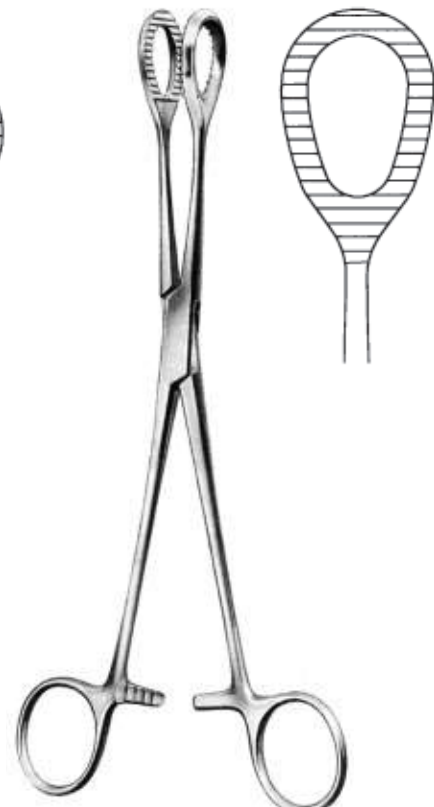

HEYWOOD - SMITH
PF 758.21
 210mm / 8 1/4"

Mastdarm-Rektum-Spekula
Rectal Specula
Specoli rettali
Espéculos rectales



CZERNY VINZENZ, * 1842

Geboren in Böhmen. War Schüler von Billroth. Unterrichtete in Freiburg und Heidelberg.
Born in Bohemia. Student of Prof. Billroth, teacher in Freiburg and Heidelberg.
Nato a Boemia. Fu allievo di Billroth. Insegnò a Friburgo ed Heidelberg.
Nacido en Bohemia. Fue alumno de Billroth. Enseñó en Friburgo y Heidelberg.



105 x 23-28mm

CZERNY
PU 605.21
210mm / 8 1/4"



75 x 17mm

SIMS
PU 613.15
150mm / 6"



75 x 17mm

SIMS
PU 615.15
150mm / 6"



80 x 25mm

PRATT
PU 619.20
200mm / 8"



90 x 15mm

MATHIEU
PU 625.19
190mm / 7 1/2"



ALAN - PARKS
PU 647.00
 140mm / 5½"

Bestehend aus: Sperrer, Mittelblatt und 2 paar Valven,
 Consisting of: Spreader, central blade and 2 pair of blades,
 Composto da: Divaricatore, valva centrale e 2 paia di valve,
 Compuesto de: Separador, valva central y 2 par de valvas



95mm
 80mm

Anuskope,
 Anuscope,
 Anoscopio,
 Anuscopio

IVES - FANSLER
PU 651.15
 150mm / 6"



Proktoskope,
 Proctoscopes,
 Proctoscopi,
 Proctoscopios

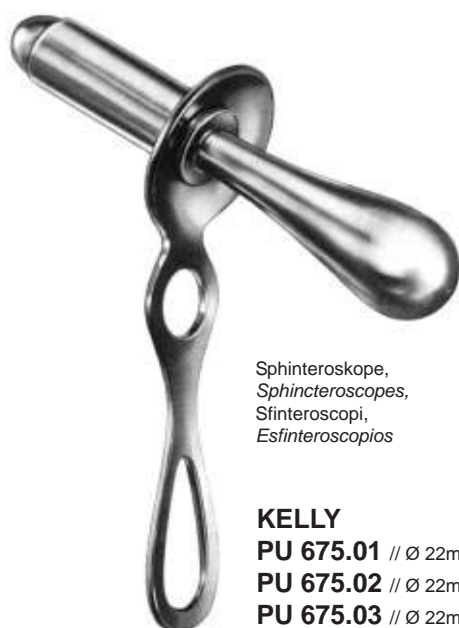

Sphinkterskope,
 Sphincteroscopes,
 Sfinteroscopi,
 Esfinteroscopios

KELLY
PU 675.01 // Ø 22mm x 50mm
PU 675.02 // Ø 22mm x 100mm
PU 675.03 // Ø 22mm x 140mm



Sphinkterskope,
 Sphincteroscopes,
 Sfinteroscopi,
 Esfinteroscopios

KELLY
PU 679.01 // Ø 21mm x 50mm
PU 679.02 // Ø 27mm x 50mm



V. PETZ
PV 530.00

PV 530.00

Magen- und Darmnähhapparat nach Dr. von Petz, komplett für 23 Paar Nähklammern, bestehend aus:

- PV 530.10 Nähapparat
- PV 530.11 Holzetui
- PV 530.12 Zusatzschloß
- PV 530.13 Kurbel
- PV 530.14 Füllständer
- PV 530.15 Füllstift
- AB 604.10 Füllpinzette
- PV 530.16 Schraubenzieher
- PV 530.17 Etui für Klammern
- PV 530.20 Silberklammern,
Pack zu 300 St.

PV 530.01 dto., jedoch ohne Holzetui

PV 530.00

Apparecchio per la sutura gastro-intestinale sec. Dr. v. Petz, completo, per 23 paia di agrafo, composto da:

- PV 530.10 Apparecchio per la sutura
- PV 530.11 Astuccio in legno
- PV 530.12 Serratura supplementare
- PV 530.13 Manovella
- PV 530.14 Supporto per caricare
- PV 530.15 Perno per posizionare le agrafo
- AB 604.10 Pinza per caricare
- PV 530.16 Cacciavite
- PV 530.17 Scatola in metallo per agrafo
- PV 530.20 Agrafo in argento,
pacchetto da 300pz.

PV 530.01 idem, però senza astuccio in legno

PV 530.00

Petz stomach and intestinal suturing apparatus, complete, for 23 pairs of suturing clips, consisting of:

- PV 530.10 Suturing apparatus
- PV 530.11 Wooden case
- PV 530.12 Additional closing clamp
- PV 530.13 Gear wheel
- PV 530.14 Filling rack
- PV 530.15 Filling pin
- AB 604.12 Filling tweezer
- PV 530.16 Screw driver
- PV 530.17 Metal box for clips
- PV 530.20 Silver suturing clips,
package of 300ea.

PV 530.01 ditto, without wooden case

PV 530.00

Aparato para suturar estómago y intestinos seg. Dr. V. Petz, completo, para 23 pares de agrafo para suturar, compuesto de:

- PV 530.10 Aparato para suturar
- PV 530.11 Estuche de madera
- PV 530.12 Cierre adicional
- PV 530.13 Manivela
- PV 530.14 Estante para rellenar
- PV 530.15 Espiga para rellenar
- AB 604.10 Pinza para rellenar
- PV 530.16 Destornillador
- PV 530.17 Estuche para agrafo
- PV 530.20 Agrafo para suturar de plata,
paquetito de 300 pzas.

PV 530.01 idem, sin estuche de madera



STRAUSS
PV 600.00

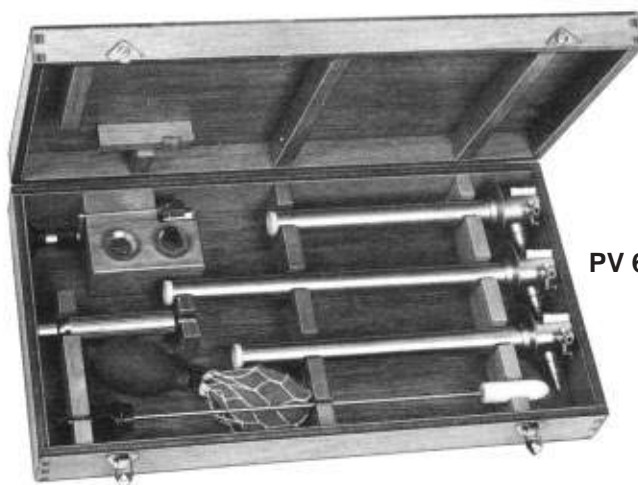

PV 602.00



PV 602.02
PV 602.03



PV 604.20
PV 604.25
PV 604.30

Ersatzlampenträger mit Lampe zu PV 600.00.
 Spare lamp carrier with lamp, for PV 600.00,
 Portalamпада di ricambio, con lampada, per PV 600.00,
 Porta-lámpara de repuesto con bombilla para PV 600.00

- PV 600.00** Rektoskop in Holzetui, bestehend aus:
 3 graduierten Tuben, 200, 250 und 300mm Nutzlänge,
 3 Lichtträgern mit Lampen, 1 verstellbaren Obturator,
 1 Handgriff mit Schalter, 1 Ansatz mit Hahn und Verschlusfenster,
 1 optischen Ansatz nach Ringleb, 1 Kabel mit Stecker,
 1 Gebläse, 3 Ersatzlampen
- PV 600.01** Ersatzlampe 4 Volt, allein
- PV 600.02** Rektoskop in Holzetui, wie PV 600.00 mit zusätzlichen Kindertubus 12mm x 150mm
- PV 602.00** Rektoskope mit Kaltlichteinrichtung in Holzetui, bestehend aus:
 3 graduierten Tuben, 200, 250 und 300mm Nutzlänge,
 3 Kaltlichtträgern, 1 verstellbaren Obturator,
 1 Handgriff, 1 Ansatz mit Hahn und Verschlusfenster,
 1 optischen Ansatz nach Ringleb, 1 Kabel mit Stecker, 1 Gebläse
- PV 602.02** Rektoskoptubus für Kinder, Nutzlänge 150mm, Ø12mm Opturator, Lichtträger und Lampe
- PV 602.03** Rektoskoptubus für Kinder, mit Kaltlichteinrichtung, Nutzlänge 150mm, Ø12mm Opturator, Kaltlichtträger

- PV 600.00** Rectoscope Set in wooden box, consisting of:
 3 graduated tubes, working length 200, 250 and 300mm,
 3 light carriers with lamps, 1 adjustable obturator,
 1 handle with switch, 1 adaptor with stopcock window,
 1 optical attachment acc. to Ringleb
 1 cord with plug, 1 rubber bulb, 3 spare bulbs
- PV 600.01** Spare bulb, 4 volt, only
- PV 600.02** Rectoscope Set, in wooden box, as PV 600.00 with additional pediatric tube 12mm x 150mm
- PV 602.00** Rectoscope Set, Cold Light, in wooden box, consisting of:
 3 graduated tubes, working length 200, 250 and 300mm,
 3 cold light conductors, 1 adjustable obturator, 1 handle,
 1 adaptor with stopcock window, 1 optical attachment acc. to Ringleb
 1 cord with plug, 1 rubber bulb
- PV 602.02** Rectoscope tube, children's, working length 150mm, Ø12mm with obturator, light carrier and lamp
- PV 602.03** Rectoscope tube, children's, cold light, working length 150mm, Ø12mm with obturator and fiber glass light conductor

- PV 600.00** Set per rettoscopia in scatola di legno, composto da:
 3 tubi graduati, lunghi 200, 250 e 300mm,
 3 portalampe con lampada,
 1 mandrino regolabile, 1 manico con interruttore,
 1 adattatore con rubinetto e finestrina di chiusura,
 1 dispositivo ottico sec. Ringleb,
 1 cordone con spina, 1 soffiera di gomma, 3 lampade di ricambio
- PV 600.01** Lampada di ricambio, 4 Volt, solo
- PV 600.02** Set per rettoscopia in scatola di legno come PV 600.00 con tubo addizionale 12mm x 150mm
- PV 602.00** Set per rettoscopia a luce fredda, in scatola di legno, composto da:
 3 tubi graduati, lunghi 200, 250 e 300mm, 3 conduttori di luce fredda,
 1 mandrino regolabile, 1 manico,
 1 adattatore con rubinetto e finestrina di chiusura,
 1 dispositivo ottico sec. Ringleb, 1 cordone con spina,
 1 soffiera di gomma
- PV 602.02** Tubo rettoscopico per bambini, lungo 150mm, Ø12mm con mandrino, portalampe e lampada
- PV 602.03** Tubo rettoscopico per bambini, a luce fredda, lungo 150mm, Ø12mm con mandrino e conduttore di luce fredda

- PV 600.00** Juego de rectoscopios en estuche de madera, compuesto de:
 3 tubos graduados, largo 200, 250 y 300mm,
 3 porta-lámparas con bombillos, 1 mandril ajustable,
 1 mango con interruptor, 1 adaptador con llave y ventana,
 1 dispositivo óptico seg. Ringleb, 1 cable con enchufe,
 1 sopleto de goma, 3 bombillos de repuesto
- PV 600.01** Bombillo de repuesto, 4 voltios, suelto
- PV 600.02** Juego de rectoscopios, en estuche de madera pero además con tubo infantil 12mm x 150mm
- PV 602.00** Juego de rectoscopios, para luz fría, en estuche de madera, compuesto de:
 3 tubos graduados, largo 200, 250 y 300mm,
 3 porta-lámparas con bombillos, 1 mandril ajustable,
 1 mango con interruptor, 1 adaptador con llave y ventana,
 1 dispositivo óptico seg. Ringleb, 1 cable con enchufe,
 1 sopleto de goma
- PV 602.02** Tubo rectoscópico para niños, largo útil 150mm, Ø12mm, con mandril, porta-luz y bombilla
- PV 602.03** Tubo rectoscópico para niños, para luz fría, largo útil 150mm, Ø12mm, con mandril y conductor de luz de fibras de cristal





**GALLE, LEBER, NIERE, BLASE, UROLOGIE
GALL, LIVER, KIDNEY, BLADDER, UROLOGY
BILE, FEGATO, RENE, VESCICA, UROLOGIA
BILIS, HÍGADO, RIÑÓN, VEJIGA, UROLOGÍA**



RANDALL
UC 101.23 - UC 111.19



Fig. 1

UC 101.23
230mm / 9"

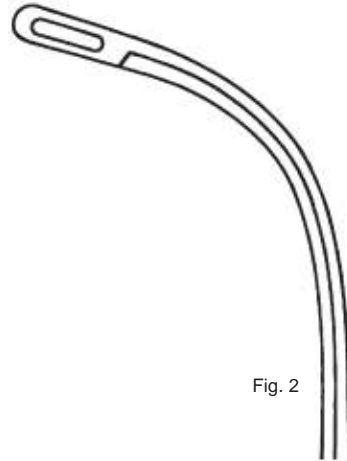

Fig. 2

UC 103.22
220mm / 8 3/4"

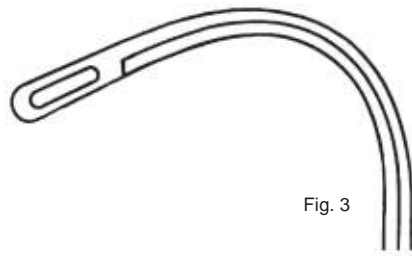

Fig. 3

UC 105.22
220mm / 8 3/4"

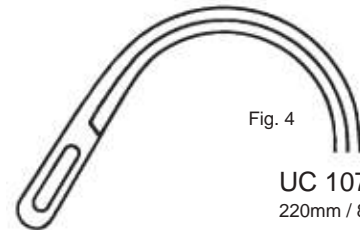

Fig. 4

UC 107.22
220mm / 8 3/4"

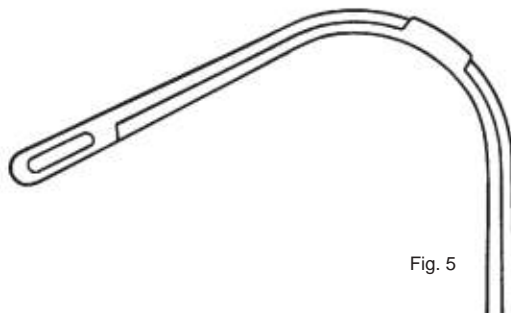

Fig. 5

UC 109.19
190mm / 7 1/2"

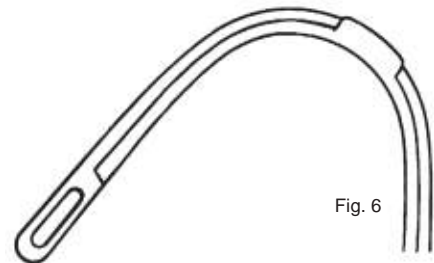

Fig. 6

UC 111.19
190mm / 7 1/2"

Nierenfistelzangen, Gallensteinzangen
Nephrostomy Forceps, Gall Stone Forceps
Pinze per nefrostomia, Pinze per calcoli biliari
Pinzas para nefrostomía, Pinzas para cálculos biliares



ELSÄSSER
UC 115.01
 200mm / 8"



ELSÄSSER
UC 115.02
 200mm / 8"

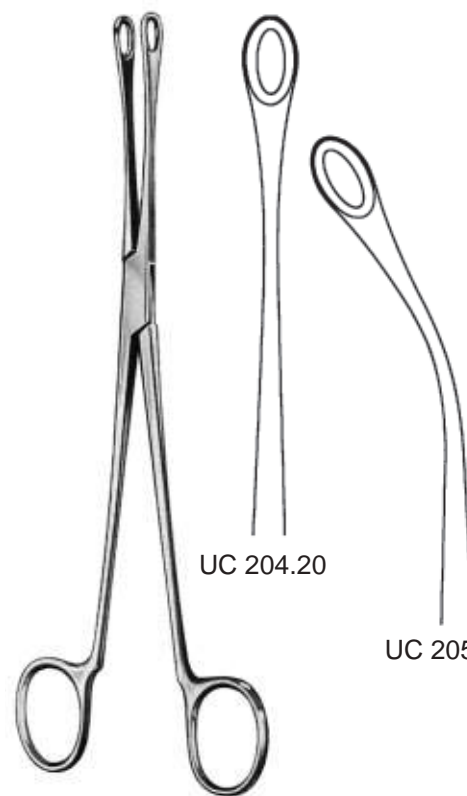

BLAKE
UC 204.20 - UC 205.20
 200mm / 8"



MAYO - BLAKE
UC 214.20
 200mm / 8"



MAYO - BLAKE
UC 215.20
 200mm / 8"



MIXTER
UC 217.22
 220mm / 8 3/4"

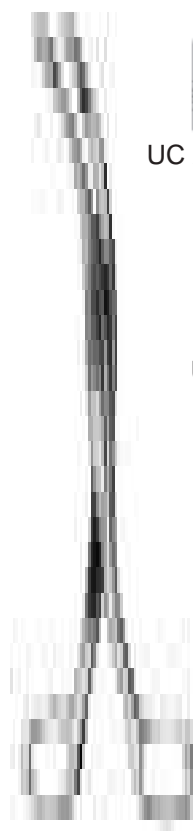

DESJARDINS
UC 223.23 - UC 225.23
 230mm / 9"

ATRAUMATIC



Kapsel­faß­zange,
Capsula Forceps,
 Pinza per prender capsule,
Pinza capsular

MILLIN
UC 451.24
 240mm / 9½"

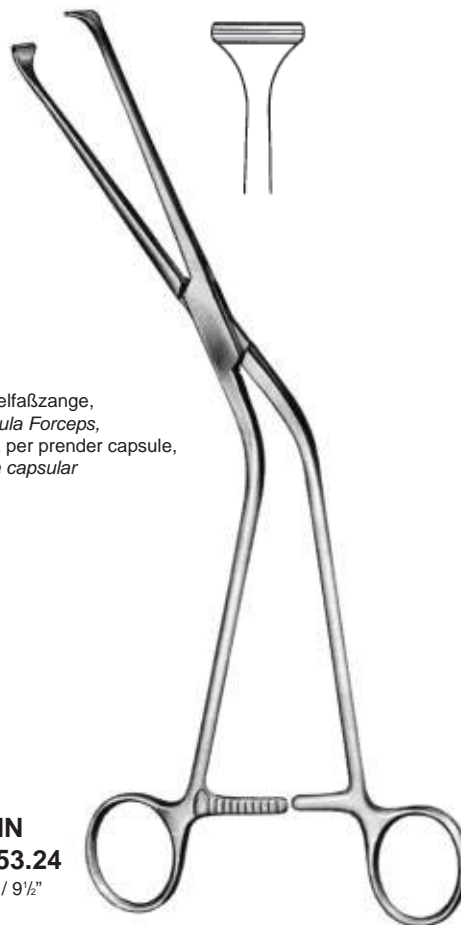

Kapsel­faß­zange,
Capsula Forceps,
 Pinza per prender capsule,
Pinza capsular

MILLIN
UC 453.24
 240mm / 9½"

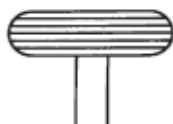

UC 461.23
 230mm / 9"

Kapsel­faß­zange zur retropubischen Prostatektomie,
Capsula forceps, for retropubic prostatectomy,
 Pinza per prendere capsule, per prostatectomia retropubica,
Pinza capsular para prostatectomia retropública



UC 463.23
 230mm / 9"

Faß­zange, 9:9 Zähne, für die vorderen Lappen,
Prostatic lobe holding forceps, for anterior lobes, 9:9 teeth,
 Pinza per afferrare i lobuli prostatici anteriori, 9:9 denti,
Pinza para coger los lóbulos anteriores, 9:9 dientes

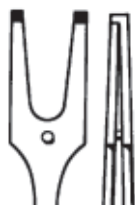

UC 465.24
 240mm / 9½"

Faden­füh­rungs­zange,
Ligature Carrying Forceps,
 Pinza portafilo,
Pinza porta-ligaduras supra-pubiana

MILLIN
UC 461.23 - UC 465.24



Penisklemmen, Sekretlöffel, Meatotom
Penis Seizing Forceps, Secretion Scoops, Meatotome
Serrapene, Cucchiai per secrezione, Meatotomo
Compresores uretrales, Cucharillas para secreciones, Meatótomo



ohne Sperre,
 without ratchet,
 senza cremagliera,
 sin cremallera

STOCKMANN
UC 875.08
 80mm / 3 1/4"



mit Sperre,
 with ratchet,
 con cremagliera,
 con cremallera

STOCKMANN
UC 877.08
 80mm / 3 1/4"



STRAUSS
UC 881.11
 110mm / 4 1/2"



ASCH
UK 746.20
 200mm / 8"



GUTTMANN
UK 840.26
 260mm / 10 1/4"

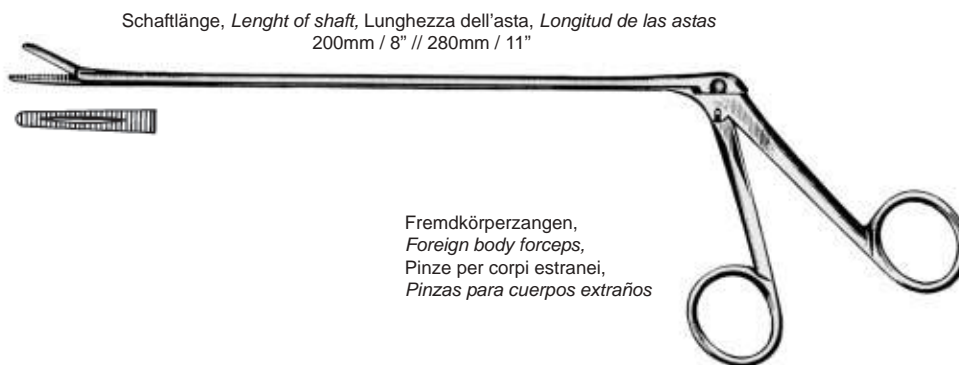

Schaftlänge, Length of shaft, Lunghezza dell'asta, Longitud de las astas
 200mm / 8" // 280mm / 11"

Fremdkörperzangen,
 Foreign body forceps,
 Pinze per corpi estranei,
 Pinzas para cuerpos extraños

MATHIEU
UF 811.20 // 200mm / 8"
UF 811.28 // 280mm / 11"

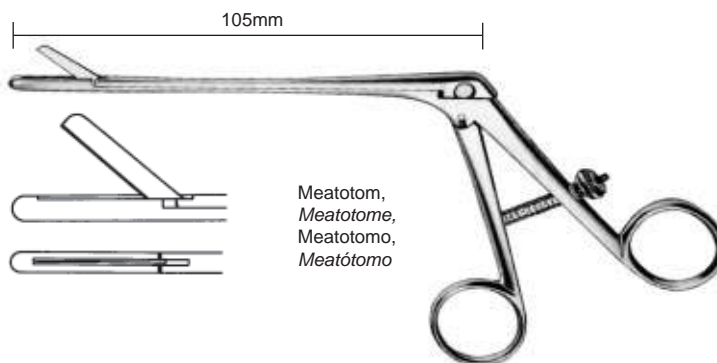

105mm

Meatotom,
 Meatotome,
 Meatotomo,
 Meatótomo

SACHSE
UV 817.12
 190mm / 7 1/2"



YOUNG
UD 401.21
210mm / 8¼"



YOUNG
UD 403.22
220mm / 8¼"



YOUNG
UD 405.22
220mm / 8¼"



YOUNG
UD 407.22
220mm / 8¼"



Blasenhalsperrer,
Bladder neck spreader,
Divaricatore del colo vescicale,
Separadores para el cuello vesical

MILLIN
UD 475.00
300mm / 12"



THOMSON - WALKER
UD 503.00



LEGUEU
UD 508.00

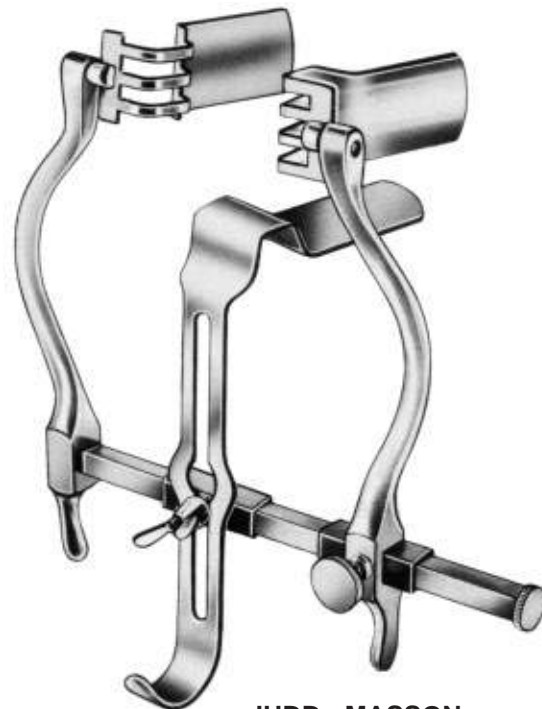

JUDD - MASSON
UD 510.00

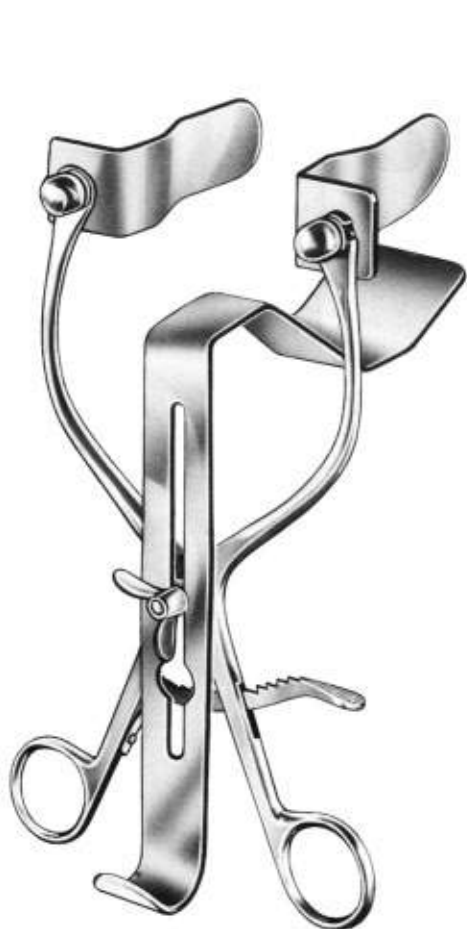

MILLIN
UD 512.00 - UD 513.01



2 Valven, *Blades, Valve, Valvas* 57 x 25mm,
2 Valven, *Blades, Valve, Valvas* 80 x 25mm,
1 Mittelvalve, *Central Blade, Valva centrale, Central valva* 120 x 45mm

UD 512.00

ohne Kaltlicht,
without fiber optic,
senza luce fredda,
sin soporte de luz fría

UD 513.00

Mittelvalve mit auswechselbarem Kaltlicht-Aufsatz,
Centre valve with interchangeable fiber optic light carrier,
Valva centrale con supporto luce fredda intercambiabile,
Valva central con soporte de luz fría intercambiabile

UD 513.01

Kaltlicht-Aufsatz für UD 513.00,
Fiber optic light carrier for UD 513.00,
Supporto luce fredda per UD 513.00,
Soporte de luz fría para UD 513.00



LEGUEU
UD 527.27
270mm / 10½"



KOCHER
UD 547.26
260mm / 10¼"

federnnd,
 elastic,
 elastici,
 elásticas

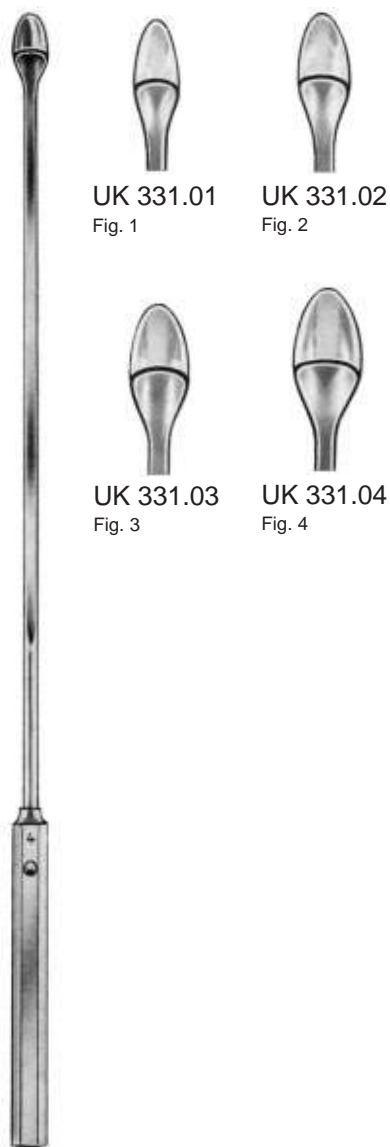

DESJARDINS
UK 331.01 - UK 331.04
 300mm / 12"

biegsam,
 malleable,
 malleabili,
 maleables



LUER - KOERTE
UK 340.01 - UK 340.08
 320mm / 12½"



MOORE
UK 355.28
280mm / 11"



MAYO
UK 358.27
270mm / 10½"

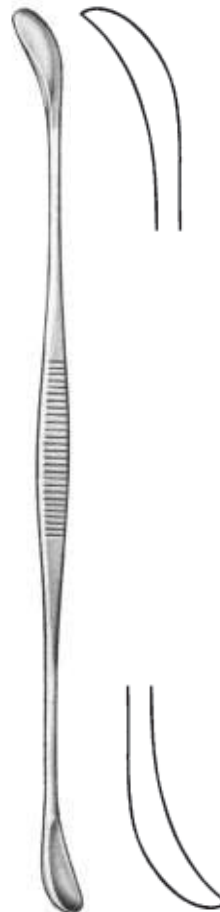

FERGUSSON
UK 362.01 - UK 362.03

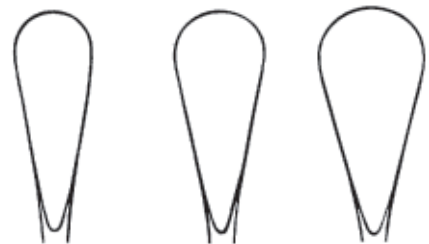

UK 362.01
210mm / 8¼"

UK 362.02
220mm / 8½"

UK 362.03
240mm / 9½"

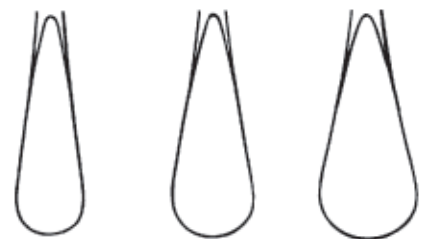

Gallensteinsonden, Gallenkanal-Dilatatoren
Gall Stone Probes, Gall Duct Dilators
Sonde per calcoli biliari, Dilatatori per condotti biliari
Sondas para cálculos biliares, Dilatadores para conductos biliares



*federnd,
 elastic,
 elastici,
 elásticas*



DESJARDINS
UQ 162.01 - UQ 162.03
 280mm / 11"

*Schaft biegsam,
 Shaft malleable,
 Asta malleabile,
 Vástago maleable*



BAKES
UQ 170.01 - UQ 170.13
 300mm / 12"

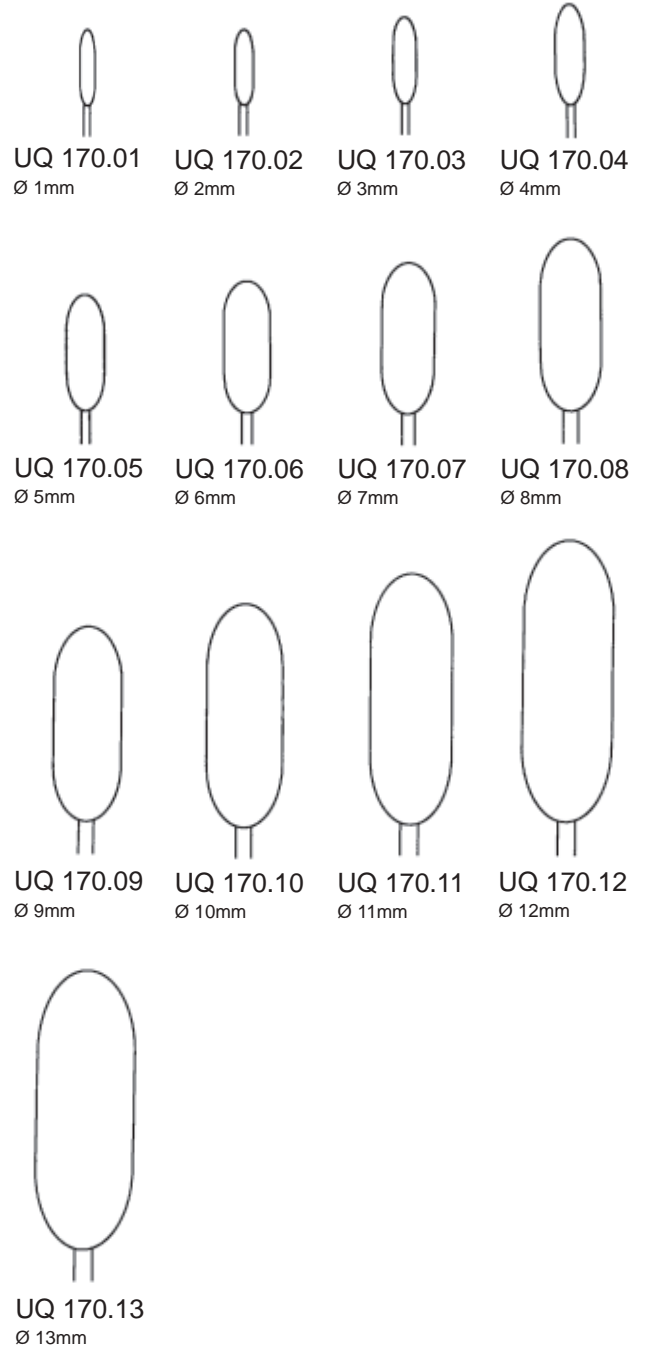



VAN BUREN
UV 599.00 - UV 599.36
 270mm / 10½"
 Charrière (French) No. 8 -36

	Ø mm	Charrière (French)
UV 599.08	2 ² / ₅	8
UV 599.10	3 ¹ / ₅	10
UV 599.12	4	12
UV 599.14	4 ² / ₅	14
UV 599.16	5 ¹ / ₅	16
UV 599.18	6	18
UV 599.20	6 ² / ₅	20
UV 599.22	7 ¹ / ₅	22
UV 599.24	8	24
UV 599.26	8 ² / ₅	26
UV 599.28	9 ¹ / ₅	28
UV 599.30	10	30
UV 599.32	10 ² / ₅	32
UV 599.34	11 ¹ / ₅	34
UV 599.36	12	36

UV 599.00
 Satz, Set, Serie, Juego



Für Frauen,
 For women,
 Per donne,
 Para mujeres

UV 721.06 - UV 721.24
 150mm / 6"
 Charrière (French) No. 6 - 24

	Ø mm	Charrière (French)
UV 721.06	2	6
UV 721.08	2 ² / ₅	8
UV 721.10	3 ¹ / ₅	10
UV 721.12	4	12
UV 721.14	4 ² / ₅	14
UV 721.16	5 ¹ / ₅	16
UV 721.18	6	18
UV 721.20	6 ² / ₅	20
UV 721.22	7 ¹ / ₅	22
UV 721.24	8	24



Für Männer,
 For men,
 Per uomini,
 Para hombres

UV 723.06 - UV 723.24
 250mm / 10"
 Charrière (French) No. 6 - 24

	Ø mm	Charrière (French)
UV 723.06	2	6
UV 723.08	2 ² / ₅	8
UV 723.10	3 ¹ / ₅	10
UV 723.12	4	12
UV 723.14	4 ² / ₅	14
UV 723.16	5 ¹ / ₅	16
UV 723.18	6	18
UV 723.20	6 ² / ₅	20
UV 723.22	7 ¹ / ₅	22
UV 723.24	8	24

Urethrotome
Urethrotome
Uretrotomi
Uretrotomos

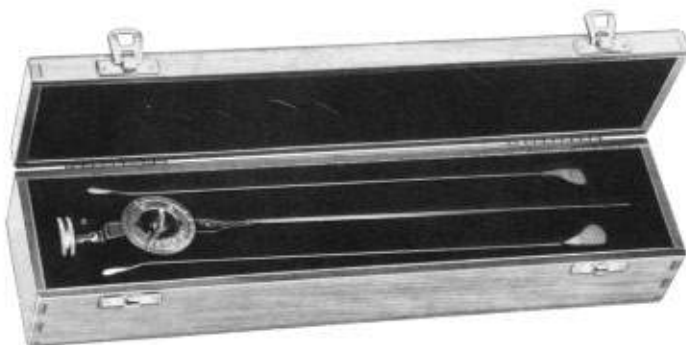

OTIS
UV 740.00

Otis Urethrotom, in Holzetui, bestehend aus:
 1 Dilator, 2 Messer, 3 Ansätze
Otis Urethrotome, in wooden case, consisting of:
 1 dilator, 2 blades, 3 tips,
 Otis Uretrotomo, in scatola di legno, composto di:
 1 dilatatore, 2 lame, 3 teste
Otis Uretrotomo, en caja de madera, compuesto de:
 1 dilatador, 2 cuchillos, 3 cabezas



UV 745.00
 Otis Ersatzmesser allein,
Otis spare blade only,
 Otis lama di ricambio, sola,
Otis cuchillo de repuesto, suelto



MAISONNEUVE
UV 755.00 - UV 757.00

UV 755.00
 Urethrotom komplett mit 2 Gleitsonden (Filiformbugies),
 1 Stilette und 3 aufwärts gestellten Messern
UV 756.00
 dto., jedoch mit einwärts gestellten Messern
UV 757.00
 Holzetui für UV 755.00 und UV 756.00

UV 755.00
 Uretrotomo, completo con 2 candelette filiformi,
 1 mandrino e 3 lame con taglio esterno
UV 756.00
 idem, ma con 3 lame con taglio interno
UV 757.00
 Scatola di legno per UV 755.00 e UV 756.00

UV 755.00
 Urethrotome, complete with 2 filiform guides,
 1 stilette and 3 outward cutting blades
UV 756.00
 ditto, but with 3 inward cutting blades
UV 757.00
 Wood Case for UV 755.00 and UV 756.00

UV 755.00
 Uretrotomo, completo con 2 bujías conductoras,
 1 estilete y 3 hojas cortantes al exterior
UV 756.00
 idem, pero con 3 hojas cortantes al interior
UV 757.00
 Estuche de madera para UV 755.00 y UV 756.00

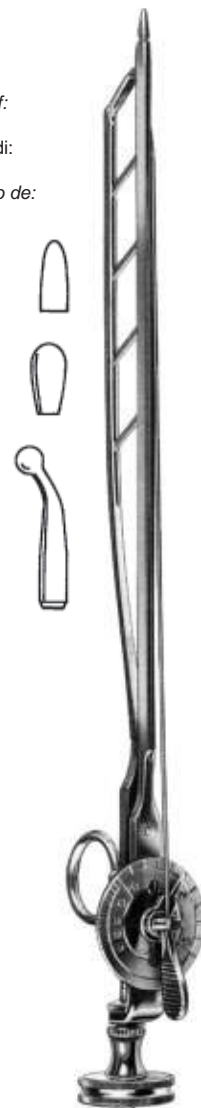
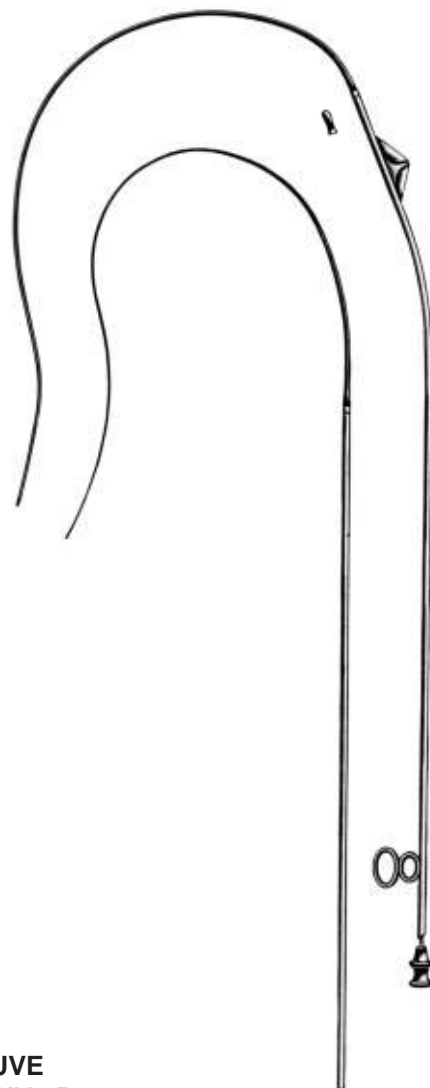



UV 763.00

Urethrographie-Instrument, bestehend aus verstellbarer Penishalterung mit verschiebbarer Kanüle mit Konus UV 763.00.

Urethrography-Instrument consisting of holder, penile, adjustable, with sliding cannula with cone UV 763.00

Strumento per ureterografia, composto da supporto per il pene regolabile, con canula scorrevole e cono UV 763.00.

Instrumento de uretrografia, compuesto de soporte para el penis ajustable, con cánula regulable con cono UV 763.00.

KNUTSON
UV 760.00



UV 765.08 - UV 765.32

Circumcisions-Instrumente,
Circumcision instruments,
 Strumenti per circoncisione,
Instrumentos para circuncisión

UV 765.08 Ø 8mm

Für Säuglinge, *baby size*, per neonati, *para bebés*,

UV 765.11 Ø 11mm

UV 765.13 Ø 13mm

Für Knaben, *child size*, per bambini, *para niños*

UV 765.16 Ø 16mm

UV 765.21 Ø 21mm

Für Jugendliche, *adolescent size*, per adolescenti, *para adolescentes*

UV 765.26 Ø 26mm

UV 765.32 Ø 32mm

Für Männer, *men's size*, per uomini, *para hombres*



Katheter-Einführungsinstrument,
Catheter introducing instrument,
 Strumento per introdurre cateteri o sonde,
Instrumento para introducir catéteres

GUYON
UV 792.39
390mm / 15½"



Katheterspanner und Einführungsinstrument,
Catheter guide (introducer),
 Mandrino guida (introduttore),
Guía para catéteres (introducor)

GUYON
UV 793.35
350mm / 13¾"



STERILISATION
STERILIZATION
STERILIZZAZIONE
ESTERILIZACIÓN



CHEATLE
SR 085.27
270mm / 10½"



SR 091.20 // 200mm / 8"
SR 091.30 // 300mm / 12"



ROGGE
SR 093.23
230mm / 9"



BUNT
SR 800.10
100mm / 4¼"

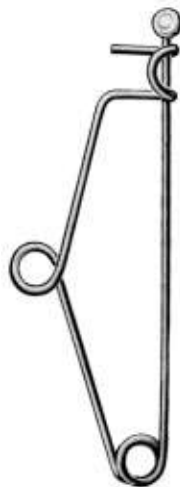

MAYO
SR 805.14
140mm / 5½"



MAYO
SR 808.14
140mm / 5½"



SR 100.01

Mehr als 400mal autoklavierbar,
More than 400 times autoclavable,
Sterilizabile più di 400 volte in autoclave,
Más de 400 usos en autoclave

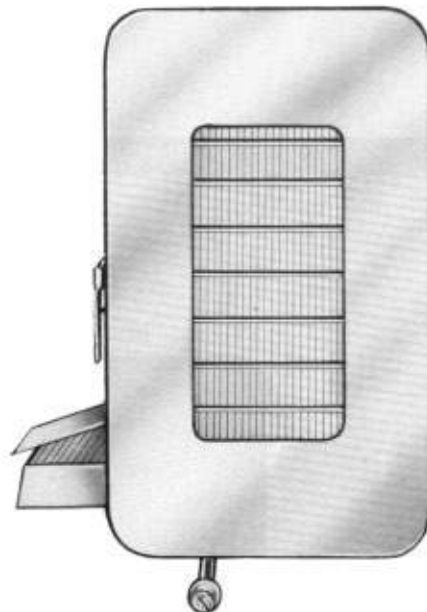

SR 150.10

Mit Aufhängevorrichtung,
With suspension hook,
Con gancio di sospensione,
Con soporte pared

Bürstenspender für 10 Bürsten (ohne Bürsten),
Dispenser for 10 brushes (without brushes),
Distributore per 10 spazzole (senza spazzole),
Dispensadores para 10 cepillos (sin cepillos)

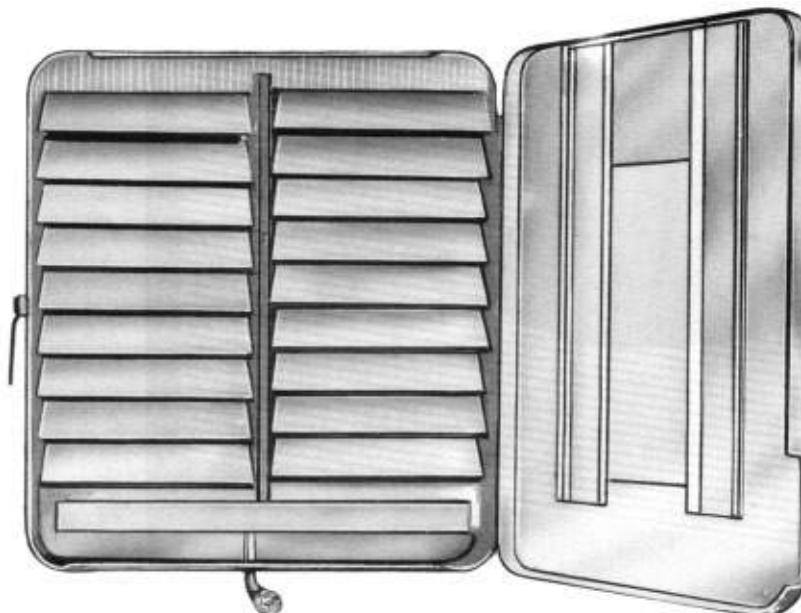

SR 150.20

Mit Aufhängevorrichtung,
With suspension hook,
Con gancio di sospensione,
Con soporte pared

Bürstenspender für 20 Bürsten (ohne Bürsten),
Dispenser for 20 brushes (without brushes),
Distributore per 20 spazzole (senza spazzole),
Dispensadores para 12 cepillos (sin cepillos)

Spülschalen, Waschschüsseln
Solution Bowls, Wash Bowls
 Scodelle per soluzioni, Scodelle per liquidi
Cubetas para soluciones, Palanganas

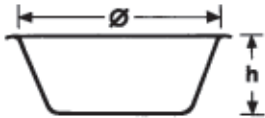

	Abmessung in mm <i>Sizes in mm</i> Dimensioni in mm <i>Tamaños en mm</i> Ø x h	Inhalt <i>Capacity</i> Capacità <i>Capacidad</i> l
SR 170.16	165 x 60	0,75
SR 170.17	175 x 70	1,00
SR 170.22	220 x 80	2,00
SR 170.23	225 x 90	2,50
SR 170.24	240 x 110	3,00
SR 170.27	275 x 115	4,50
SR 170.29	290 x 125	6,00
SR 170.31	310 x 120	6,00
SR 170.34	345 x 125	8,50
SR 170.38	380 x 120	11,00



	Abmessung in mm <i>Sizes in mm</i> Dimensioni in mm <i>Tamaños en mm</i> Ø x h	Inhalt <i>Capacity</i> Capacità <i>Capacidad</i> l
SR 176.33	330 x 90	6,0
SR 178.33	330 x 115	8,0

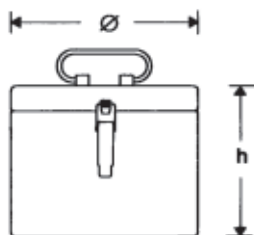

SCHIMMELBUSCH
 SR 200.08 - SR 200.39

Abmessung in mm
 Sizes in mm
 Dimensioni in mm
 Tamaños en mm
 Ø x h

SR 200.08	80 x 80
SR 200.12	120 x 120
SR 200.14	140 x 140
SR 200.16	160 x 120
SR 200.17	160 x 150
SR 200.19	190 x 150
SR 200.20	190 x 190
SR 200.23	240 x 160
SR 200.24	240 x 240
SR 200.28	290 x 160
SR 200.29	290 x 240
SR 200.33	340 x 160
SR 200.34	340 x 240
SR 200.38	390 x 190
SR 200.39	390 x 290



KONRICH
 SR 452.10 - SR 452.39

Abmessung in mm
 Sizes in mm
 Dimensioni in mm
 Tamaños en mm
 Ø x h

Filter, 5 Paar
 Filters, 5 pairs
 Filtri, (5 paia)
 Filtros (5 pares)

SR 452.10	100 x 100	SV 455.10
SR 452.15	150 x 150	SV 455.15
SR 452.20	200 x 150	SV 455.20
SR 452.21	200 x 190	SV 455.21
SR 452.24	240 x 160	SV 455.24
SR 452.25	240 x 230	SV 455.25
SR 452.29	290 x 160	SV 455.29
SR 452.30	290 x 240	SV 455.30
SR 452.33	340 x 160	SV 455.33
SR 452.34	340 x 240	SV 455.34
SR 452.37	390 x 145	SV 455.37
SR 452.38	390 x 240	SV 455.38
SR 452.39	390 x 290	SV 455.39

Runde Schalen, Meßbecher
Round Bowls, Graduated Measures
Scodelle rotonde, Bicchieri graduati
Cubetas redondas, Copas graduadas



SR 225.11



	Abmessung in mm Sizes in mm Dimensioni in mm Tamaños en mm Ø x h	Inhalt Capacity Capacità Capacidad l
SR 224.11	110 x 27	0,2
SR 226.11	110 x 40	0,3



	Abmessung in mm Sizes in mm Dimensioni in mm Tamaños en mm Ø x h	Inhalt Capacity Capacità Capacidad l
SR 231.04	40 x 19	0,05
SR 231.06	61 x 30	0,07
SR 231.08	80 x 14	0,14
SR 231.11	116 x 50	0,35
SR 231.12	128 x 55	0,45
SR 231.14	147 x 65	0,7
SR 231.16	167 x 75	1,1
SR 231.18	187 x 85	1,6



	Abmessung in mm Sizes in mm Dimensioni in mm Tamaños en mm Ø x h	Inhalt Capacity Capacità Capacidad l
SR 235.11	116 x 35	0,3
SR 235.12	128 x 38	0,4
SR 235.14	147 x 40	0,5
SR 235.16	157 x 45	0,75
SR 235.18	187 x 45	1,0



	Abmessung in mm Sizes in mm Dimensioni in mm Tamaños en mm Ø x h	Inhalt Capacity Capacità Capacidad l
SR 240.11	110 x 28	0,15



SR 254.01
100 cc // 0,1l



SR 256.02 // 0,25 l
SR 256.05 // 0,5 l
SR 256.10 // 1,0 l
SR 256.20 // 2,0 l

Nadel-Sterilisierkästchen
Needle Sterilizing Cases
Scatole per sterilizzare aghi
Estuche para esterilizar agujas

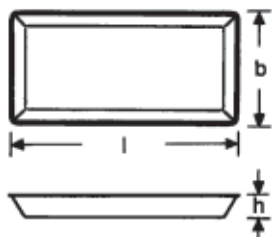

Abmessung in mm
 Sizes in mm
 Dimensioni in mm
 Tamaños en mm
 l x b x h

SR 300.50 55 x 25 x 4,5
SR 300.65 65 x 42 x 8
SR 300.75 75 x 25 x 4,5



Abmessung in mm
 Sizes in mm
 Dimensioni in mm
 Tamaños en mm
 l x b x h

SR 302.50 55 x 25 x 4,5
SR 302.65 65 x 42 x 8
SR 302.75 75 x 25 x 4,5



Abmessung in mm
 Sizes in mm
 Dimensioni in mm
 Tamaños en mm
 Ø x h

SR 309.65 65 x 15



Innendose allein,
 Inner case only,
 Scatola interna sola,
 Caja interior suelta

Abmessung in mm
 Sizes in mm
 Dimensioni in mm
 Tamaños en mm
 Ø x h

SR 310.65 62 x 13



SAUERBRUCH

Abmessung in mm
 Sizes in mm
 Dimensioni in mm
 Tamaños en mm
 l x b x h

SR 162.20 210 x 125 x 17



SAUERBRUCH

Abmessung in mm
 Sizes in mm
 Dimensioni in mm
 Tamaños en mm
 l x b x h

SR 164.20 210 x 125 x 17

Nadel-Sterilisierkästchen
Needle Sterilizing Cases
Scatole per sterilizzare aghi
Estuche para esterilizar agujas

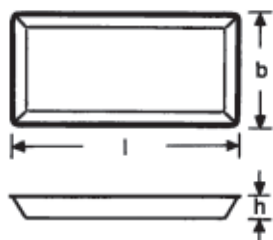

Abmessung in mm
 Sizes in mm
 Dimensioni in mm
 Tamaños en mm
 l x b x h

SR 335.01 150 x 95 x 13



Abmessung in mm
 Sizes in mm
 Dimensioni in mm
 Tamaños en mm
 l x b x h

SR 335.02 150 x 95 x 13



Abmessung in mm
 Sizes in mm
 Dimensioni in mm
 Tamaños en mm
 l x b x h

SR 335.03 150 x 95 x 13



Abmessung in mm
 Sizes in mm
 Dimensioni in mm
 Tamaños en mm
 l x b x h

SR 335.05 150 x 95 x 13



Abmessung in mm
 Sizes in mm
 Dimensioni in mm
 Tamaños en mm
 l x b x h

SR 337.01 150 x 95 x 13



Abmessung in mm
 Sizes in mm
 Dimensioni in mm
 Tamaños en mm
 l x b x h

SR 337.02 150 x 95 x 13



Abmessung in mm
 Sizes in mm
 Dimensioni in mm
 Tamaños en mm
 l x b x h

SR 340.02 150 x 95 x 11

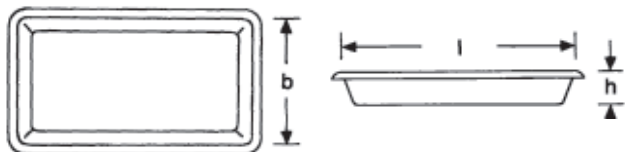

SR 321.23 - SR 321.40

Abmessung in mm
 Sizes in mm
 Dimensioni in mm
 Tamaños en mm
 l x b x h

SR 321.23	230 x 155 x 30
SR 321.30	300 x 175 x 30
SR 321.31	300 x 175 x 40
SR 321.35	350 x 240 x 36
SR 321.40	400 x 300 x 40



SR 324.21 - SR 324.42

Abmessung in mm
 Sizes in mm
 Dimensioni in mm
 Tamaños en mm
 l x b x h

SR 324.21	210 x 160 x 10
SR 324.24	140 x 180 x 10
SR 324.30	310 x 150 x 10
SR 324.31	310 x 210 x 10
SR 324.35	350 x 240 x 10
SR 324.40	400 x 270 x 20
SR 324.42	420 x 280 x 10



Abmessung in mm
 Sizes in mm
 Dimensioni in mm
 Tamaños en mm
 l x b x h

SR 340.23 235 x 190 x 40



Abmessung in mm
 Sizes in mm
 Dimensioni in mm
 Tamaños en mm
 Ø x h

SR 348.22 220 x 70



SR 358.25 - SR 358.32

SR 358.25
 Kornzange bestehend aus: 1 Kornzange 250mm, gebogen,
 mit Kappe (Deckel), 1 Standgefäß mit großer Bodenplatte (standsicher)
SR 358.32
 dito, mit 320mm langer Kornzange

SR 358.25
*Sterilizing forceps consisting of: 1 sterilizing forceps 250mm, curved,
 without ratchet with lid for jar, 1 jar with wide bottom plate (anti-tilt)*
SR 358.32
ditto, with 320mm long sterilizing forceps

SR 358.25
 Pinza-coperchio composto di: 1 pinza medicatura 250mm, curva,
 senza cremagliera, con coperchio per il contenitore, 1 contenitore con
 fondo grande (stabile)

SR 358.32
 idem, con pinza medicatura 320mm

SR 358.25
*Combinación tapa/pinza compuesta de: 1 pinza para vendaje 250mm,
 curva, sin cremallera, con tapa para tarro, 1 tarro con placa de pie
 grande (estable)*

SR 358.32
idem, con pinza para vendaje 320mm

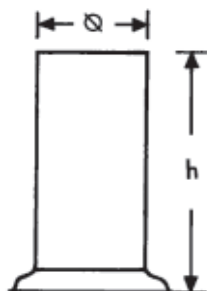

SR 360.30 - SR 360.99



SR 365.50 - SR 365.99

Gefäße (ohne Deckel)
Jars (without lid)
 Recipienti (s.coperch.)
Tarros (sin tapa)

Abmessung in mm
Sizes in mm
 Dimensioni in mm
Tamaños en mm
 Ø x h

Deckel allein
Lid only
 Coperchio solo
Tapa suelta

	Abmessung in mm <i>Sizes in mm</i> Dimensioni in mm <i>Tamaños en mm</i> Ø x h	Deckel allein <i>Lid only</i> Coperchio solo <i>Tapa suelta</i>
SR 360.30	30 x 90	----
SR 360.50	50 x 100	SR 365.50
SR 360.51	50 x 130	SR 365.50
SR 360.52	50 x 175	SR 365.50
SR 360.75	75 x 100	SR 365.75
SR 360.76	75 x 130	SR 365.75
SR 360.77	75 x 175	SR 365.75
SR 360.98	100 x 175	SR 365.99
SR 360.99	100 x 200	SR 365.99

Sterilisierbehälter, Sterilisier-und Bereitschaftskästen
Sterilizing Boxes, Sterilizing and Storing Cases
Scatole per sterilizzazione e scatole per conservazione
Cajas para la esterilización y cajas para conservación

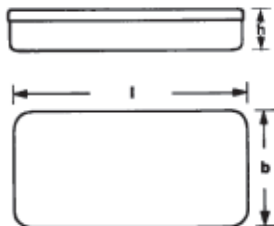

SR 399.35 - SR 399.60

Abmessung in mm
 Sizes in mm
 Dimensioni in mm
 Tamaños en mm
 l x b x h

SR 399.35	245 x 135 x 35
SR 399.50	245 x 135 x 50
SR 399.60	245 x 135 x 60

Mit Filterboden, with filter botton,
 Con filtro nel fondo, con fondo de filtro



SR 400.23 - SR 402.42

Abmessung in mm
 Sizes in mm
 Dimensioni in mm
 Tamaños en mm
 Ø x h

Filter, 5 Paar
 Filters, 5 pairs
 Filtri, (5 paia)
 Filtros (5 pares)

SR 400.23	230 x 130 x 50	SV 409.23
SR 400.26	260 x 150 x 50	SV 409.26
SR 400.27	275 x 235 x 50	SV 409.27
SR 400.30	300 x 200 x 50	SV 409.30
SR 400.32	325 x 275 x 50	SV 409.32
SR 400.42	420 x 175 x 50	SV 409.42
SR 402.23	230 x 130 x 75	SV 409.23
SR 402.26	260 x 150 x 75	SV 409.26
SR 402.30	300 x 200 x 75	SV 409.30
SR 402.32	325 x 275 x 75	SV 409.32
SR 402.42	420 x 175 x 75	SV 409.42

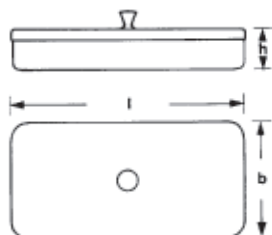

SR 411.16 - SR 412.33

Mit Knopfdeckel
Lid with knob
 Con coperchio a bottone
Tapa con botón

Deckel ohne Knopfdeckel
Lid without knob
 Coperchio senza bottone
Tapa sin botón

Abmessung in mm
Sizes in mm
 Dimensioni in mm
 Tamaños en mm
 l x b x h

SR 411.16	SR 412.16	165 x 85 x 35
SR 411.20	SR 412.20	200 x 100 x 35
SR 411.21	SR 412.21	200 x 100 x 50
SR 411.23	SR 412.23	230 x 130 x 50
SR 411.26	SR 412.26	260 x 150 x 50
SR 411.27	SR 412.27	270 x 235 x 50
SR 411.30	SR 412.30	300 x 200 x 50
SR 411.33	SR 412.33	325 x 275 x 50



Abmessung in mm
Sizes in mm
 Dimensioni in mm
 Tamaños en mm
 l x b x h

SR 419.20 205 x 105 x 40

Behälter, Stationsgefäße
Receptacles
 Recipienti
 Recipientes

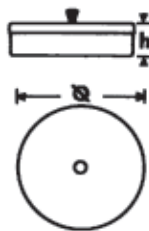

SR 430.06 - SR 435.15

Dosen für Watte, Tampons,
Containers for cotton wool, pellets,
 Recipienti per ovata, tamponi,
 Recipientes para algodón, tampones

Abmessung in mm
Sizes in mm
 Dimensioni in mm
 Tamaños en mm
 Ø x h

SR 430.06	75 x 60
SR 430.07	75 x 75
SR 431.06	100 x 60
SR 431.10	100 x 100
SR 432.08	125 x 80
SR 432.12	125 x 125
SR 435.15	150 x 150



Medizinbecher,
Medicine cups,
 Bicchieri per medicinali,
 Vasos graduadas

SR 602.25 // 25cc
SR 602.50 // 50cc



Medizinlöffel,
Medicine spoon,
 Cucchiaino per medicinali,
 Cucharas graduadas

SR 610.20 // 20cc



Tablettenschale,
Tray for medicine,
 Bacinella per medicinali,
 Plato para medicinas

SR 620.75
 Ø 75 x 12mm



Sputumbecher,
Sputum cup,
 Sputacchiera,
 Escupidera

SR 662.75
 Ø 75 x 80mm

Nierenschalen, Stechbecken, Dreieckschalen, Placentabecken
Kidney Bowls, Bed Pans, Triangular Basin, Placenta Pan
 Bacinelle reniformi, Padelle, Bacinelle triangolare e per placenta
 Cuñas, Cubeta triangular, Cubetas para placenta

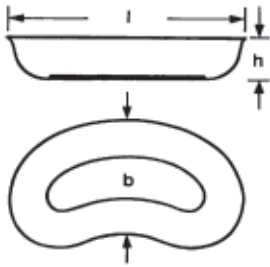

Abmessung in mm
 Sizes in mm
 Dimensioni in mm
 Tamaños en mm
 l x b x h

SR 673.17	170 x 100 x 35
SR 673.25	250 x 140 x 40
SR 673.27	275 x 150 x 45

SR 673.17 - SR 673.27



SR 702.23 // Ø 235mm
 SR 702.31 // Ø 310mm



Abmessung in mm
 Sizes in mm
 Dimensioni in mm
 Tamaños en mm
 Ø x h

SR 712.22 220 x 120



SR 740.30



SR 741.30

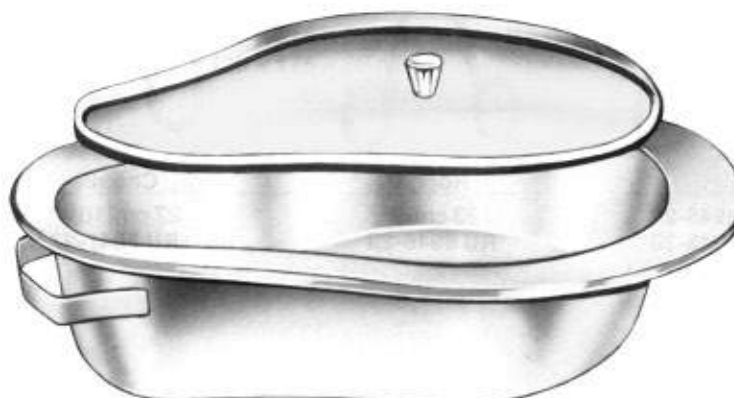

SR 750.36

Sterilisiersiebschalen
Sterilizing Trays
Cestelli per la sterilizzazione
Bandejas de esterilización



Abmessung in mm
 Sizes in mm
 Dimensioni in mm
 Tamaños en mm
 l x b x h

SR 808.24 240 x 240 x 50



Abmessung in mm
 Sizes in mm
 Dimensioni in mm
 Tamaños en mm
 l x b x h

SR 809.24 260 x 260 x 50
SR 809.26 260 x 260 x 80
SR 809.27 260 x 260 x 100

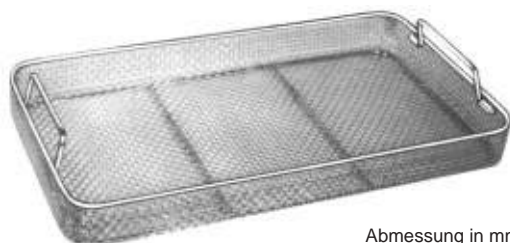

Abmessung in mm
 Sizes in mm
 Dimensioni in mm
 Tamaños en mm
 l x b x h

SR 808.48 480 x 250 x 50
SR 808.75 520 x 250 x 75
SR 808.99 520 x 250 x 100



Abmessung in mm
 Sizes in mm
 Dimensioni in mm
 Tamaños en mm
 l x b x h

SR 809.48 480 x 260 x 50
SR 809.75 520 x 260 x 75
SR 809.99 520 x 260 x 100



Abmessung in mm
 Sizes in mm
 Dimensioni in mm
 Tamaños en mm
 l x b x h

SR 800.60 60 x 60 x 30



Abmessung in mm
 Sizes in mm
 Dimensioni in mm
 Tamaños en mm
 Ø x h

SR 850.07 75 x 90
SR 850.10 100 x 130



METHOT
SR 860.01 - SR 860.02

Mit Deckel
 With lid
 Con coperchio
 Con tapa

Ohne Deckel
 Without lid
 Senza coperchio
 Sin tapa

Abmessung in mm
 Sizes in mm
 Dimensioni in mm
 Tamaños en mm
 Ø x h

SR 860.01 **SR 860.02** 50 x 75



METHOT
SR 868.01

METHOT
SR 868.05

Abmessung in mm
 Sizes in mm
 Dimensioni in mm
 Tamaños en mm
 Ø x h

SR 868.01 50 x 75
SR 868.05 45 x 45





WA 301.10
100mm / 4¹/₄"

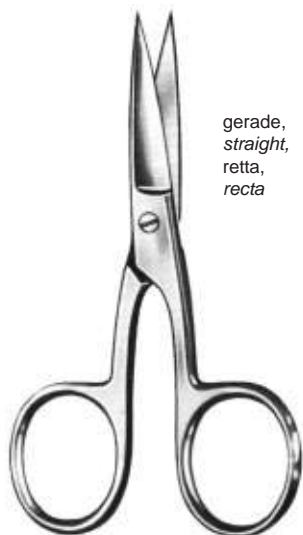

gerade,
straight,
retta,
recta

WA 304.10
100mm / 4¹/₄"

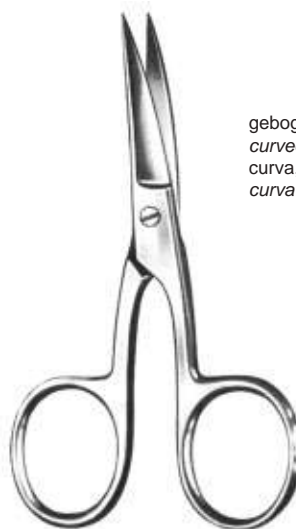

gebogen,
curved,
curva,
curva

WA 305.10
100mm / 4¹/₄"



WA 320.13 // 130mm / 5"
WA 320.15 // 150mm / 6"



WA 378.10
100mm / 4¹/₄"



WA 379.10
100mm / 4¹/₄"



WI 331.14
140mm / 5¹/₂"



WI 336.14 // 140mm / 5¹/₂"
WI 336.16 // 160mm / 6¹/₂"



TURNBULL
WI 341.11 // 110mm / 4½"
WI 341.13 // 130mm / 5"
WI 341.15 // 150mm / 6"



WI 347.13
 130mm / 5"



WI 353.12
 120mm / 4¾"



WI 360.11 // 110mm / 4½"
WI 360.13 // 130mm / 5"
WI 360.15 // 150mm / 6"



WI 365.11 // 110mm / 4½"
WI 365.13 // 130mm / 5"



WI 373.10
 100mm / 4¼"

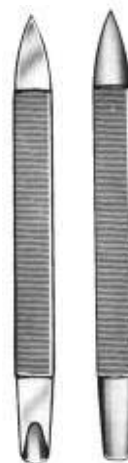

WV 386.10 // 100mm / 4¼"
WV 386.12 // 120mm / 4¾"



WV 389.16
 160mm / 6½"

Wasserstrahlreinigungspistole mit Aufsätzen
Water Jet Pistol with Several Tips
Pistola lavatrice a getto d'acqua con vari raccordi
Pistola-lavatoria de chorro de agua con varias toberas



WV 101.00

Wasserstrahlreinigungspistole, komplett, mit 9 Aufsätzen WV 101.01 - WV 101.09, mit Aufsteckleiste, 1m Druckschlauch, Schelle und Aufhängehaken für Pistole.

WV 101.00

Water Jet Pistol complet with 9 tips WV 101.01 - WV 101.09 and 1m pressure tubing, with strap and suspension hook.

WV 101.00

Pistola lavatrice a getto d'acqua, completa con 9 raccordi WV 101.01 - WV 101.09 e tubo ad alta pressione di 1m, con graffa e gancio di sospensione.

WV 101.00

Pistola-Lavatoria de chorro de agua con 9 toberas WV 101.01 - WV 101.09 y tubo de presión de 1m, con abrazadera y gancho de suspensión.

Aufsätze für Wasserstrahlreinigungspistole
Tips for Water Jet Pistol
Raccordi per pistola lavatrice a getto d'acqua
Toberas para pistola-lavatoria de chorro de agua



WV 101.01

Reinigungsaufsatz für Flaschen,
Cleaning tip for bottles,
 Raccordo di lavaggio per bottiglia,
Tobera para botellas



WV 101.02

Reinigungsaufsatz für Record-Spritzen-Konen,
Cleaning tip for cones of Record syringes,
 Raccordo di lavaggio per siringhe con cono Record,
Tobera para jeringas con cono Record



WV 101.03

Reinigungsaufsatz für Katheter,
Cleaning tip for catheters,
 Raccordo di lavaggio per cateteri,
Tobera para catéteres



WV 101.04

Reinigungsaufsatz für Drainageschläuche,
Cleaning tip for drainage tubings,
 Raccordo di lavaggio per tubi di drenaggio,
Tobera para tubos de drenaje



WV 101.05

Reinigungsaufsatz für Hohlgefäße (Brause),
Cleaning tip for receptacles (shower),
 Raccordo di lavaggio per recipienti (doccia),
Tobera para recipientes (ducha)



WV 101.06

Reinigungsaufsatz für Kanülen und Record-Konus,
Cleaning tip for hypodermic needles with Record Cone,
 Raccordo di lavaggio per aghi ipodermici con cono Record,
Tobera para agujas de inyección con cono Record



WV 101.07

Reinigungsaufsatz für Kanülen und Luer-Konus,
Cleaning tip for hypodermic needles with Luer Cone,
 Raccordo di lavaggio per aghi ipodermici con cono Luer,
Tobera para agujas de inyección con cono Luer



WV 101.08

Reinigungsaufsatz für Meß- und Vollpipetten,
Cleaning tip for measure and volumetric pipettes,
 Raccordo di lavaggio per tubi di per pipette comuni e graduate ,
Tobera para pipetas de medida y volumétricas



WV 101.09

Reinigungsaufsatz für feine Pipetten (Ery/Leuco),
Cleaning tip for fine pipettes (Ery/Leuco),
 Raccordo di lavaggio per pipette fine (Eritro/Leuco) ,
Tobera para pipetas finas (Eritrocito/Leuccocito)



WV 101.10 // 310mm / 12 1/4"

Reinigungsaufsatz, gerade,
Cleaning tip straight,
 Raccordo di lavaggio, retto,
Tobera de limpieza, recta,



WV 101.11 // 310mm / 12 1/4"

Reinigungsaufsatz, gebogen,
Cleaning tip curved,
 Raccordo di lavaggio, curvo,
Tobera de limpieza, curva



WV 102.02

Überwurfmutter zum Anschluß an Gewindehähne, 1/2 Zoll,
Coupling for connection to water tap, 1/2 inch,
 Raccordo per connessione ai rubinetti filettati, 1/2 polici,
Tuercas-hembras para conexión al grifo de agua, 1/2 pulgada



WV 104.70
ca. 120cc



WV 112.12
ca. 120cc



WV 120.12
ca. 120cc



WV 146.04
WV 147.04
Ø 4mm

WV 146.04
Ersatzdocht, rund, Ø 4mm, per Meter,
Spare wicks, round, Ø 4mm, one meter,
Lucignolo, rotondo, Ø 4mm, per metro,
Mecha de repuesto, redonda, Ø 4mm, por metro

WV 147.04
dito, 120mm lang,
ditto, 120mm long,
idem, 120mm lunghezza,
idem, 120mm de longitud







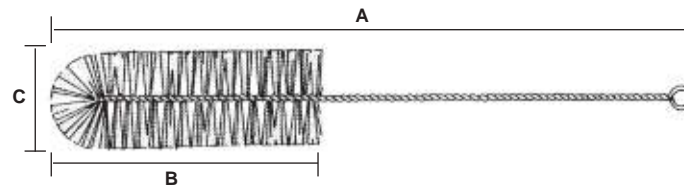

WV 148.12
WV 149.12
Ø 12mm

WV 148.12
Ersatzdocht, flach, Ø 12mm, per Meter,
Spare wicks, flat, Ø 12mm, one meter,
Lucignolo, piatto, Ø 12mm, per metro,
Mecha de repuesto, plano, Ø 12mm, por metro

WV 149.12
dito, 120mm lang,
ditto, 120mm long,
idem, 120mm lunghezza,
idem, 120mm de longitud



A // Gesamtlänge, *Total length*, Lunghezza totale, Longitud total,
 B // Bürstenlänge, *Length of brush*, Lunghezza della spazzola, Longitud del cepillo
 C // Bürstendurchmesser, *Ø of brush*, Ø della spazzola, Ø del cepillo

						
	WV 301.03	WV 303.03	WV 304.07	WV 306.08	WV 306.13	WV 351.50
A	245mm	420mm	285mm	270mm	215mm	330mm
B	65mm	65mm	75mm	65mm	60mm	130mm
C	3mm	3mm	7mm	8mm	13mm	50mm



WV 455.15
 Deckel, *Lid*,
 Coperchio, *Tapa*



Abmessung in mm	Inhalt
<i>Sizes in mm</i>	<i>Capacity</i>
Dimensioni in mm	Capacità
<i>Tamaños en mm</i>	<i>Capacidad</i>
Ø x h	l

WV 454.15	325 x 305	15
------------------	-----------	----



WV 470.58
 580mm / 22 3/4"



SAUERBRUCH
WV 474.55
 550mm / 21 1/2"

INHALTSVERZEICHNIS
INDEX
INDICE ALFABETICO
INDICE





A			
Abfalleimer	498	Baby-Doyen Darmklemmen	444
Abfallzangen	498	Baby-Metzenbaum Supercut Scheren	67
Ablegeplatten, Instrumente-.....	483	Baby-Mikulicz Peritoneumklemmen	143
Abortusküretten	368	Baby-Mixer Arterienklemmen	117
Abortuslöffel	368	Baby-Overholt Arterienklemmen	119
Absaugküretten.....	350	Baby-Roux Wundhaken.....	189
Abwurfeimer.....	498	Backhaus Tuchklemmen	144
Adlerkreutz Chirurgische Pinzetten	103	Bailey-Baby Rippenkontraktoren.....	334
Adson Anatomische Pinzetten	95	Bailey-Gibbon Rippenkontraktoren	334
Adson Arterienklemmen.....	121,127	Bailey Rippenkontraktoren.....	334
Adson Bohrinstrumente	423	Bainbridge Atraumatic Cardiovascularklemmen	306
Adson-Brown Chirurgische Pinzetten	106	Bakes Gallenkanal- Dilatoren.....	471
Adson-Brown CT-ORO Pinzetten	98	Balfour-Baby Bauchdeckenhalter	209
Adson Chirurgische Pinzetten	104	Balfour Bauchdeckenhalter	209,210
Adson CT-ORO Pinzetten.....	98	Balfour US-Type Bauchdeckenhalter	211
Adson Elevatorien.....	375	Barraquer Cilienpinzetten.....	111
Adson Nadelhalter	223	Barraquer CT-ORO Nadelhalter	232
Adson Saugrohre.....	283	Barraquer Mikro- Nadelhalter	218,219
Adson Wundsperrer.....	193,196,198	Barraquer-Trounman Mikro- Nadelhalter.....	218
Akku-Einsatz für Batteriegriff	279	Barrett Hakenzangen.....	341
Alan Parks Analspreizer	457	Batteriegriffe für Laryngoskope.....	279
Alderdyce Elevatorien	377	Bauchdeckenhalter.....	203-205,208-214
Alexander Osteotome	408	Bauchspatel	186,187,216
Alexander Raspatorien	422	Beacham Hakenzangen.....	341
Alexander Uterus- Biopsiezangen	346	Beck Atraumatic Cardiovascularklemmen.....	318,322
Allis-Adair Gewebe- und Organfasszangen	254	Beckenzirkel	369
Allis Gewebe- und Organfasszangen, Atraumatic	254,255	Beckmann-Adson Wundsperrer.....	199
Allison Lungenspatel	334	Beckmann-Eaton Wundsperrer	199
Alm Wundsperrer	191	Beckmann Wundsperrer	198
Aly Sensibilitäts- Instrumente.....	267	Beebee Kronenscheren.....	53
Amputations- und Resektionssägen	427	Beer Cilienpinzetten.....	111
Analspreizer.....	457	Behälter	487
Anastomosen- und Rektumklemmen, Atraumatic.....	452,453	Behälter, Sterilisier-.....	479,485
Anastomosenklemmen	448	Bengolea Arterienklemmen	124
Anatomische Pinzetten.....	93-96	Bennett Meniskushaken	380
Anatomische Skalpelle	2	Bereitschaftskästen	485
Anderson-Adson Wundsperrer	192	Bergmann Hämmer	431
Anestrophon Stethoskope.....	268	Bergmann Verbandscheren.....	63
Anuskope, Sphinkteroskope	457	Berliner Perkussionshämmer	266
Aorta Dilatatoren.....	336	Bernhard Tuchklemmen.....	145
Arruga CT-ORO Nadelhalter.....	232	Bertilion Schädel- Messzirkel	269
Arruga Mikro- Nadelhalter.....	218,221	Beschneidungsinstrumente	474
Arterienklemmen	116-129,131-134,138,139	Bestecke, Krampfader-.....	263
Arterienklemmen, Atraumatic.....	297	Bestecke, Laryngoskopie	275-278
Asch Sekretlöffel	465	Beyer Hohlmeisselzangen	391
Atraumatic Anastomosenklemmen	452,453	Biopsie- und Saugküretten	347
Atraumatic Arterienklemmen.....	297	Biopsiezangen, Mastdarm-.....	454,455
Atraumatic Bulldogklemmen	115,295,296,302,303	Bircher-Ganske Knochenhalte-zangen	382
Atraumatic Bulldogklemmen, Titan-.....	293	Bircher Meniskusmesser	372
Atraumatic Cardiovascularklemmen.....	297-301,304-326	Birkett Arterienklemmen	128
Atraumatic Darm- und Magenklemmen	449-452	Blake Gallensteinzangen	463
Atraumatic Gewebe- und Organ- Fasszangen	256,258	Blake Uterus Küretten.....	350
Atraumatic Pinzetten.....	292	Blasen- Wundspreizer	467,468
Atraumatic Rektum- Anastomosenklemmen.....	452,453	Bleihände.....	440
Aufsätze für Wasserstrahlreinigungspistole.....	495	Blount Meniskushaken	380
Auward Scheidenspekula	357	Blumenthal Hohlmeisselzangen.....	390
Ayre Konusmesser	340	Blutdruckmessapparate	271
		Böhler Extensionsbügel.....	436
		Böhler Hohlmeisselzangen	391
		Böhler Knochesplitterzangen.....	395
		Bohrapparate.....	424-426
		Bohrinstrumente, Pfrieme	423
B		Bonney Chirurgische Pinzetten	108
Babcock Atraumatic Gewebe- und Organfasszangen.....	256	Bonney CT-ORO Pinzetten	97
Babcock CT-ORO Gewebe- und Organfasszangen.....	256	Boynton Nadelhalter	227
Baby-Allis Gewebe- und Organfasszangen	254	Boys-Allis Gewebe- und Organfasszangen	254
Baby-Collin Bauchdeckenhalter	203		
		Bozemann CT-ORO Nadelhalter	237
		Bozemann-Douglas Korn-, Tuperzangen	150
		Bozemann Korn-, Tuperzangen.....	150
		Brand Sehnenfassinstrumente.....	373
		Braun Hakenzangen	341,343
		Braun Scheidenhalter	355
		Braun Scheidenspekula	355
		Braun-Stadler Scheren.....	48
		Braun-Stadler Supercut Scheren	70
		Braun Uterusdepressoren.....	350
		Breisky Beckenzirkel	369
		Breisky Scheidenspekula	358
		Bronchus- und Gallenkanalklemmen.....	133,134
		Bronchusklemmen	294
		Brophy Chirurgische Pinzetten	105
		Brophy(Sullivan) Scheren.....	43
		Brom Venenhaken.....	160
		Brown Nadelhalter	222
		Brunner Atraumatic Darmklemmen	452
		Brunner Ferrozell Führungshohlsonden	248
		Brunner Führungshohlsonden	247
		Brunner Rippenscheren	291
		Brunner Wundhaken	175-177
		Bruns CT-ORO Verbandscheren	64
		Bruns Verbandscheren	62
		Bruns Scharfe Löffel	402,404
		Bruns Verbandscheren	61
		Buck Ligaturscheren	60
		Buck Perkussionshämmer	266
		Bulldogklemmen	114,115
		Bulldogklemmen Atraumatic	115,295,296,302,303
		Bulldogklemmen Atraumatic, Titan-.....	293
		Bunnell Handbohrapparate.....	426
		Bunnell Sehnenstripper	438,439
		Bunt Sterilisierklammern	476
		Burford Rippenspreizer aus Leichtmetall.....	329
		Bürsten- Reinigungs-.....	497
		Bürsten, Handwasch-.....	477
		Bürstspender	477
		Busch Scheren	49
		Byrd Saugrohre.....	286
		C	
		Cardiovascular- Klemmen, Atraumatic	297-301,304-326
		Caroll Finger- Goniometer	269
		Caroll Sehnenfassinstrumente	373
		Carrel Arterienklemmen.....	116
		Castanares Supercut Scheren.....	73
		Castaneda Kinder- und Neonatalklemmen	326
		Castaneda Rippenspreizer aus Leichtmetall.....	329
		Castroviejo-Barraquer Mikro- Nadelhalter.....	221
		Castroviejo CT-ORO Nadelhalter	231,232
		Castroviejo-Fino Mikro- Nadelhalter	220
		Castroviejo Rasierklängenbrecher	6
		Castroviejo Standard Mikro- Nadelhalter	220
		Catroviejo Mikro- Nadelhalter.....	219-221
		Chadwick Feine Chirurgische Scheren	42
		Chaput Organ- Gewebe- Fasszangen	257
		Charrière Amputationsägen	427
		Cheatle Sterilisierzangen	476
		Cheavlier Rippenspreizer	332
		Cheron Korn-, Tuperzangen	150
		Childe Wundklammernpinzetten	250
		Chirurgische Pinzetten	101-108
		Chirurgische Scheren.....	16-22



Cilienpinzetten.....	110,111	D	
Cleveland Hohlmeisselzangen.....	389	Dale Atraumatic Cardiovascularclennen.....	299
Cleveland Knochensplitterzangen.....	394	Dandy Arterienclennen.....	120
Cloward Wundsperrerr.....	197	Dandy Scheren.....	46
Coller-Crile Arterienclennen.....	120	Dardik Atraumatic Cardiovascularclennen.....	298
Collier Nadelhalter.....	222	Darm- und Magennähapparate.....	458
Collin Bauchdeckenhalter.....	203,204	Darm- und Magenquetschclennen.....	446
Collin Beckenzirkel.....	369	Darmclennen.....	444, 445, 448
Collin-Duval Gewebe- und Organfasszangen.....	254	Darmclennen, Atraumatic.....	449-452
Collin Dynamometer.....	269	Darmscheren.....	59
Collin Hämmer.....	428	Darmspatel.....	186,187
Collin-Hartmann Wundhaken.....	188	Dartigues Uterus- Fasszangen.....	344
Collin Knochen- und Rippenscheren.....	290	Daubenspeck Scharfe Löffel.....	405
Collin Korn-, Tupferzangen.....	149	Davidson Wundhaken.....	174
Collin-Landau Scheidenspekula.....	351	De Bakey (Glover) Atraumatic Cardiovascularclennen.....	317
Collin-Loktite Bauchdeckenhalter.....	204	De Bakey Atraumatic Cardiovascularclennen.....	305-309, 312, 315, 319
Collin Nabelschnurclennen.....	366	De Bakey Atraumatic Pinzetten.....	292
Collin Organ- Gewebe- Fasszangen.....	257	De Bakey-Bahnson Atraumatic Cardiovascularclennen.....	313
Collin Scheidenspekula.....	351	De Bakey Carotis Atraumatic Bulldogclennen.....	295
Collin Skalpellgriffe.....	8	De Bakey CT-ORO Nadelhalter.....	235
Collin Uterus- Fasszangen.....	344	De Bakey CT-ORO Pinzetten.....	100
Collin Uterus- Sonden.....	350	De Bakey-Dietrich Bulldogclennen, Atraumatic.....	115
Collin Wundhaken.....	189	De Bakey Gefäss- Dilatoren.....	337
Collin Wundclennen.....	250	De Bakey-Mosquito Atraumatic Arterienclennen.....	297
Converse CT-ORO Nadelhalter.....	233	De Bakey-Pean Atraumatic Cardiovascularclennen.....	316
Cooley Atraumatic Cardiovascularclennen.....	301,320,321	De Bakey-Rankin Atraumatic Arterienclennen.....	297
Cooley Atraumatic Pinzetten.....	292	De Bakey Rippensperrerr.....	331
Cooley-Derra Atraumatic Cardiovascularclennen.....	322	De Bakey-Satinsky Atraumatic Bulldogclennen.....	295
Cooley Dilatoren.....	336	De Bakey Wundsperrerr.....	202
Cooley Gefäss- Dilatoren.....	337	De Bakey(Potts-Smith) CT-ORO Scheren.....	87
Cooley Rippensperrerr aus Leichtmetall.....	327	De Martel-Wolfson Anastomosencclennen.....	448
Cooley Saugrohre.....	285	Dean CT-ORO Scheren.....	88
Cooley Wundhaken.....	183	Dean Scheren.....	47
Cooper Unterbindungsnadeln.....	243	Deaver Inzisionsscheren.....	23
Coryllos Wundhaken.....	174	Deaver Wundhaken.....	181-183
Cottle Hämmer.....	429	Déjerine Perkussionshämmer.....	266
Cottle-Kazanjan Knochensplitterzangen.....	394	Demel Drahtumführungsnadeln.....	434
Cottle Scheren.....	47	Denis-Browne Bauchdeckenhalter.....	211
Cottle Supercut Scheren.....	70	Depressoren.....	350
Coupland Saugrohre.....	286	Derf CT-ORO Nadelhalter.....	233
Crafoord Arterienclennen.....	128	Derf Nadelhalter.....	222
Crafoord Scheren.....	44	Dermatome.....	13
Crawfoord Wundhaken.....	178	Derra Atraumatic Cardiovascularclennen.....	318
Crile Arterienclennen.....	120	Deschamps Unterbindungsnadeln.....	244-246
Crile-Murray Nadelhalter.....	223	Desjardins Gallenkanalclennen.....	137
Crile Nadelhalter.....	226	Desjardins Gallensteinlöffel.....	469
Crile-Rankin Arterienclennen.....	120	Desjardins Gallensteinsonden.....	471
Crile-Wood CT-ORO Nadelhalter.....	234	Desjardins Gallensteinzangen.....	463
Crile-Wood Nadelhalter.....	223	Desmarres Wundhaken.....	156
CT-ORO Drahtzangen.....	397,400	Dieffenbach Bulldogclennen.....	114
CT-ORO Flachzangen.....	399	Dietrich Bulldogclennen, Atraumatic.....	115
CT-ORO Gewebe- und Organfasszangen.....	256	Dietrich Atraumatic Cardiovascularclennen.....	297
CT-ORO Nadelhalter.....	231-240	Dietrich CT-ORO Nadelhalter.....	231
CT-ORO Pinzetten.....	97-100	Dietrich Scheren.....	45
CT-ORO Scheren.....	74-87	Dilatationsbougies.....	472
CT-ORO Verbandscheren.....	63	Dilatoren, Aorta.....	336
Cusco Scheidenspekula.....	351	Dilatoren, Gallenkanal.....	471
Cushing Anatomische Pinzetten.....	96	Dilatoren, Gefäss.....	337
Cushing Chirurgische Pinzetten.....	105	Dilatoren, Uterus.....	360-362
Cushing CT-ORO Pinzetten.....	98	Dingmann Knochenhalte zangen.....	382
Cushing Raspatorien.....	418	Douglas Cilienpinzetten.....	111
Cushing-Taylor CT-ORO Pinzetten.....	98	Douglas Trokare.....	283
Cushing Wundhaken.....	158,159	Doyen Atraumatic Darmclennen.....	449
Cuzzi Abortuslöffel.....	368		
Czerny Hakenzangen.....	343	Doyen Darmclennen.....	444
Czerny Mastdarm-Spekulum.....	456	Doyen Gynäkologische Scheren.....	30
		Doyen Hämmer.....	428
		Doyen Myomheber.....	340
		Doyen Raspatorien.....	421
		Doyen Scheidenspekula.....	356,357,359
		Doyen Sonden.....	262
		Doyen-Stille Wundhaken.....	169
		Doyen Tuchclennen.....	145
		Doyen Uterus- Polypenzangen.....	344
		Doyen Wundhaken.....	172
		Draht- Kneifzangen.....	398,400
		Draht- Kneifzangen CT-ORO.....	400
		Drahtspanninstrumente.....	435
		Drahtumführungsnadeln.....	435
		Drahtzange, CT-ORO.....	397
		Drahtzangen.....	398,400
		Dreher, Schrauben.....	433
		Dreieckschalen.....	488
		Duplay Hakenzangen.....	341
		Duplay Kornzangen.....	148
		Duplex Stethoskope.....	268
		Durante Chirurgische Pinzetten.....	107
		Durchzugsinstrumente.....	438,439
		Duval CT-ORO Gewebe- und Organfasszangen.....	256
		Duval Gewebe- und Organfasszangen.....	257
		E	
		Echlin Hohlmeisselzangen.....	392
		Eimer.....	498
		Einführungsinstrumente.....	474
		Eiselsberg Ligaturscheren.....	60
		Elevatoren.....	375,376
		Elliot Geburtszangen.....	366
		Elsässer Nierenfistelzangen.....	463
		Endarterektomiestripper.....	264
		Endospekula.....	359
		Engl.Modell Tuchclennen.....	144
		Enukleationsscheren.....	52
		Episiotomie- Scheren.....	48
		Eppendorf Uterus- Biopsiezangen.....	346
		Ersatzbirnen für Laryngoskopie- Spatel.....	279
		Esmarch Verbandscheren.....	61
		Extensionsbügel.....	436,437
		F	
		Fadenknoter,-fänger.....	249
		Farabeuf-Collin Raspatorien.....	419
		Farabeuf Knochenhalte zangen.....	385
		Farabeuf-Lambotte Knochenhalte zangen.....	385
		Farabeuf Raspatorien.....	419
		Farabeuf Wundhaken.....	188
		Farrel (Lathbury- Uebe) Watteträger.....	264
		Fassinstrumente, Sehnen.....	373,374
		Fasszangen.....	398
		Fasszangen- Organ- Gewebe-, Atraumatic.....	256,258
		Fasszangen- Organ- Gewebe-, CT-ORO.....	256
		Fasszangen, Organ- und Gewebe-.....	254,255,257,259
		Fasszangen, Prostata.....	464
		Fasszangen, Prostata-, Atraumatic.....	464
		Fasszangen, Uterus.....	344
		Faure Klemmzangen.....	142
		Faure Peritoneumclennen.....	143
		Faure Uterus- Biopsiezangen.....	345



Fehland Rektumklemmen Atraumatic	453	Gerald Chirurgische Pinzetten	105	Halter, Bauchdecken-	203-205,208-214
Feilchenfeld Splitterpinzetten	110	Gerald CT-ORO Pinzetten	97	Halter, Nadel-	222-227
Feilen, Knochen-	434	Gewebe- und Organ- Fasszangen	254,255,257,259	Halter, Nadel, CT-ORO	231-240
Feilen, Nagel-	493	Gewebe- und Organ- Fasszangen CT-ORO	256	Halter, Scheiden-	353-359
Feine Pinzetten	109	Gewebe- und Organ- Fasszangen, Atraumatic	256,258	Hämmer	428-432
Feldheim Instrument für Finger- und Zehnnägel	440	Giertz-Stille Rippenscheren	291	Hämmer, Perkussions-	266
Fergusson Gallensteinlöffel	470	Gil-Vernet Wundhaken	159	Hämorrhoidalzangen	455
Fergusson Knochenhalte-zangen	384	Gillies Chirurgische Pinzetten	104	Handwaschbürsten	477
Fergusson Saugrohre	283	Gillies CT-ORO Nadelhalter	238	Hank Uterus- Dilatatoren	362
Ferris-Smith Chirurgische Pinzetten	108	Gillies CT-ORO Pinzetten	97	Harken Atraumatic Cardiovascular-klemmen	311
Ferrozell Führungshohlsonden	248	Gillies-Mini CT-ORO Nadelhalter	238	Harrington-Pemberton Wundhaken	180
Fingerringssägen	441	Gillies Nadelhalter	226	Harrington Wundhaken	180
Finocchietto (modif.) Rippensperrerr	330	Gillies Wundhaken	160	Hartmann Arterienklemmen	117
Finocchietto-Baby-Haight Rippensperrerr		Gipsscheren	63	Hartmann Hohlmeisselzangen	389
aus Leichtmetall	328	Glover Atraumatic Bulldogklemmen	295,303	Hayes Rektumklemmen Atraumatic	452
Finocchietto-Baby Rippensperrerr	333	Gluck Rippenscheren	290	Heaney Klemmzangen	140
Finocchietto CT-ORO Nadelhalter	236	Goelert Wundhaken	190	Heaney Nadelhalter	224
Finocchietto Gallenkanalklemmen	134	Goldmann-Fox CT-ORO Scheren	87	Hebel, Knochen-	377-380
Finocchietto Nadelhalter	225	Goldman-Fox Scheren	50	Heber- Myom-	340
Finocchietto Rippensperrerr	333	Gomel Mikro- Scheren	55	Hegar-Baumgartner CT-ORO Nadelhalter	233
Finocchietto Rippensperrerr aus Leichtmetall	328	Gomel Tumorpinzetten	91	Hegar-Baumgartner Nadelhalter	222
Finsen Mod.Martin Wundsperrerr	191	Good Scheren	47	Hegar CT-ORO Nadelhalter	237
Finsen Wundsperrerr	191	Gorney Präparierscheren	38	Hegar Nadelhalter	224
Fischer Sehnenstripper	439	Gorney Supercut Scheren	72,73	Hegar Uterus Dilatatoren	360,361
Fistelhaken, Konusmesser	340	Gosset Bauchdeckenhalter	208	Hegar-Vascular CT-ORO Nadelhalter	237
Flachzangen CT-ORO	399	Gourdet Uterus Löffel	348	Hegenbarth Wundklammernpinzetten	250
Flachzangen Draht- Kneifzangen	398	Graefe Scheren	51	Heiss Arterienklemmen	127
Foerster Bauchdeckenhalter	213	Graefe Wundhaken	155	Henley Wundsperrerr	195
Foerster Tupferzangen	151	Grave Scheidenspekula	352	Hepp/Scheidel Mikro- Scheren	55,57
Fomon Scheren	47	Gray Gallenkanalklemmen	137	Hepp/Scheidel CT-ORO Nadelhalter	231
Fomon Supercut Scheren	70	Grazil Chirurgische Scheren	22,52	Herrick Nierenstiellklemmen	136
Ford Stethoskope	268	Green-Armytage Kopfschwartenzangen	367	Heymann Supercut Scheren	70
Foregger Laryngoskope	278	Greene Uterus- Küretten	348	Heymann Tonsillen- und Nasenscheren	47
Foregger Laryngoskopie- Bestecke	278	Gregory Atraumatic Cardiovascular-klemmen	299	Heywood-Smith Mastdarm- Biopsieklemmen	455
Foregger Laryngoskopie- Spatel	278	Gregory-Soft Atraumatic Bulldogklemmen	296	Hibbs Osteotome	415,416
Franz Bauchdeckenhalter	212	Griffe, Skalpell-	7-10	High-Qualität Scheren	65
Frazier Saugrohre	283	Gross-Maier Korn-, Tupferzangen	149	Himmesser	4
Freemann-Gorney Supercut Scheren	72	Gruenwald CT-ORO Pinzetten	99	Hoer Raspatorien	418
Freemann-Kaye Supercut Scheren	72	Gruenwald-Jansen Tamponpinzetten	112	Hohlmeisselzangen	388-393
Freemann Supercut Scheren	72	Guedel Laryngoskopie- Spatel	276	Hohlsonden, Führungs-	247-249
Fremdkörperzangen	148	Guedel-Negus Laryngoskope	276	Hohmann Knochenheber	378,379
Friedmann Hohlmeisselzangen	388	Guedel-Negus Laryngoskopie- Bestecke	276	Hoke Osteotome	415
Fritsch Wundhaken	171	Gunnar-Hey Schlauchroller	146	Holzbach Bauchdeckenhalter	205
Frosch Knochenhalte-zangen	384	Guthrie Wundhaken	155	Hösel Wundhaken	170
Frykholm Hohlmeisselzangen	393	Guttman Sekretlöffel	465	Hudson Handbohrapparate	424
Fuchs Arterienklemmen	121	Guyon Katheter- Einführungsinstrumente	474	Hunt Mikro- Pinzetten	90
Führungshohlsonden	247-249	Guyon Nierenstiellklemmen	135	Hunter Splitterpinzetten	110
Führungsnadeln	287	Guyon Nierenstiellklemmen, Atraumatic	135	Husfeldt Atraumatic Cardiovascular-klemmen	300
		Gynäkologische Scheren	28-30	Hysterektomie-klemmen	140,142
				Hysterektomie-klemmen, Atraumatic	141
G					
Gallenkanal- Dilatatoren	471	H		I	
Gallenkanalklemmen	133,134,137	Haberer Bauchspatel	216	Instrumente für Finger- und Zehnnägel	440,441
Gallensteinlöffel	469,470	Haight Rippensperrerr	330	Instrumente, Beschneidungs-	474
Gallensteinsonden	471	Haken, Fistel-	340	Instrumente, Bohr-	423
Gallensteinzangen	463	Haken, Mensikus-	380	Instrumente, Drahtspann-	435
Garrett Gefäss- Dilatatoren	337	Haken, Prostata-	466	Instrumente, Durchzugs-	438,439
Gazespender	490	Haken, Spinal-	380	Instrumente, Einführungs-	474
Geburtslöffel	368	Haken, Wund-	154-185,188-190	Instrumente, Mess-	269,270
Geburtszangen	366	Haken, Wund-, Titan	154	Instrumente, Naht-	241,242
Gefäss- Dilatatoren	337	Hakenzangen	341-343	Instrumente, Prüf-	269
Gefässspülkanülen	338	Halle Scharfe Löffel	405	Instrumente, Sensibilitäts-	267
Gellhorn Uterus- Biopsiezangen	345	Halsey CT-ORO Nadelhalter	233	Instrumentenablegeplatten	483
Gelpi-Loktite Wundsperrerr	202	Halsey Nadelhalter	222	Instrumentenkästen	486
Gemini Präparier- und Ligaturklemmen	130	Halsted-Mosquito Arterienklemmen	117,118	Intima Spatel	335
Gerald Anatomische Pinzetten	96	Halteklemmen, Knochen-	381		



Inzisionsscheren	23	Klemmen, Arterien-, Atraumatic	297	Lambert-Kay Atraumatic Cardiovascularklemmen	312
Iowa Hakenzangen.....	342	Klemmen, Bronchus-	133,134,294	Lambotte Knochenhalte­zangen	385
Isreal Wundhaken	163	Klemmen, Bulldog-.....	114,115	Lambotte Osteotome	414
Ives-Fansler Anuskope	457	Klemmen, Bulldog-, Atraumatic.....	115,295,296,302,303	Lambotte Raspatorien	422
J		Klemmen, Bulldog-, Atraumatic, Titan-	293	Laminektomiespreizer.....	215
Jackson-Burrows Wundsperrerr.....	202	Klemmen, Cardiovascular-, Atraumatic	297-301,304-326	Lampen, Spiritus-.....	496
Jackson Scheidenspekula	353	Klemmen, Darm-.....	444,445,448	Landau Scheidenspekula.....	358
Jacobs Bohrapparate.....	425	Klemmen, Darm-, Atraumatic	449-452	Lane Chirurgische Pinzetten	108
Jacobs Hakenzangen	343	Klemmen, Darmquetsch-.....	446	Lane Knochenhalte­zangen.....	386
Jacobson-Adson Arterienklemmen	121	Klemmen, Gallenkanal-	133,134,137	Lane Magenklemmen.....	447
Jameson Scheren.....	46	Klemmen, Hysterektomie-	140,142	Lane Schraubendreher.....	433
Jamison Nadelhalter.....	224	Klemmen, Hysterektomie-,Atraumatic	141	Lane Tuchklemmen	145
Jansen Hohlmeisselzangen.....	388,389	Klemmen, Ligatur-	127-132,138,139	Lange-Hohmann Knochenhebel	379
Jansen Ohrpinzetten.....	112	Klemmen, Magen-	447	Lange Verbandscheren	61
Jansen Wundsperrerr.....	191	Klemmen, Magen-, Atraumatic	449-452	Lange Wundklammernpinzetten	250
Javid Atraumatic Cardiovascularklemmen	300	Klemmen, Magenquetsch-.....	446	Langenbeck Amputationssägen	427
Johns-Hopkins Bulldogklemmen.....	114	Klemmen, Nabelschnur-	366	Langenbeck CT-ORO Nadelhalter	240
Johnson Nadelhalter	225	Klemmen, Neonatal- und Kinder-, Atraumatic	323-326	Langenbeck Elevatorien	375
Jones-Speziell Tuchklemmen	144	Klemmen, Nierenstiel-	135,136	Langenbeck Knochenhalte­zangen	384
Jones Tuchklemmen.....	144	Klemmen, Nierenstiel-, Atraumatic	135	Langenbeck Raspatorien	418,419
Joseph Scheren.....	42	Klemmen, Penis-	465	Langenbeck Wundhaken.....	164
Judd-Allis Gewebe- und Organfasszangen	254	Klemmen, Peritoneum-	143	Laryngoskope	275-279
Judd-Masson Blasen- Wundspreizer	467	Klemmen, Präparier-	127-132,138,139	Laryngoskopie- Bestecke	275-278
K		Klemmen, Rektum-, Atraumatic	452,453	Laryngoskopie- Spatel.....	275-278
Kader Spatel	186	Klemmen, Tuch-	144-146	Lawrence Präparierklemmen.....	139
Kallmorgen Scheidenhalter	355	Klemmen, Vaginal-.....	140,142	Lebsche Sternummeissel	291
Kallmorgen Scheidenspekula.....	355	Klemmzangen	140,142	Lees Atraumatic Cardiovascularklemmen	311,312
Kalt Mikro- Nadelhalter.....	218	Knapp Scheren.....	52	Legueu Bauchdeckenhalter	208
Kane Nabelschnurklemmen	366	Knochenfeilen	434	Legueu Blasen- Wundspreizer.....	467,468
Kanülen, Gefäßsspül-	338	Knochenhalteklammern	381	Leichtmetall- Rippenperrerr	327-329
Kappenzangen.....	484	Knochenhalte­zangen	381-388	Leland-Jones Atraumatic Cardiovascularklemmen.....	306
Kästen, Instrumente-	486	Knochenhebel.....	377-380	Leksell-Stille Hohlmeisselzangen	392
Katheter- Einführungsinstrumente	474	Knochenscheren	290	Lempert Hohlmeisselzangen	389
Katheter, Metall-.....	472	Knochensplitterzangen	394-396	Lempert Scharfe Löffel	403
Katheterzangen	274	Knorpelmesser.....	3	Lerche Chirurgische Pinzetten.....	103
Kaye Supercut Scheren	73	Knowles Verbandscheren	62	Lerliche Arterienklemmen	119
Kelly Arterienklemmen	119,138	Knutson Urethrographie- Instrumente.....	474	Lerliche Bauch- und Darmspatel	187
Kelly CT-ORO Scheren.....	88	Kocher Arterienklemmen	122,125,126	Lewin Knochenhalte­zangen	383
Kelly-Rankin Arterienklemmen	119	Kocher Atraumatic Darmklemmen	450,451	Lexer-Baby Präparierscheren.....	39
Kelly Scheren.....	31	Kocher Blasen- Wundspreizer	468	Lexer CT-ORO Scheren.....	81
Kelly Sphinkteroskope	457	Kocher Darmklemmen	445	Lexer-Fino Präparierscheren.....	40
Kelly Uterus- Polypenzangen.....	344	Kocher-Langenbeck Wundhaken	165	Lexer Meissel	412,413
Kelly Wundhaken	168,184	Kocher-Nippon Arterienklemmen.....	123	Lexer Präparierscheren.....	39
Kern Knochenhalte­zangen.....	385	Kocher Wundhaken	161,167,172	Lexer Supercut Scheren	68
Kevorkian Uterus- Biopsieküretten	347	Koerte Bauch- und Darmspatel.....	186	Lichtenberg CT-ORO Nadelhalter	240
Kevorkian Uterus- Biopsiezangen	346	Koerte Wundhaken	162	Lichtenberg Nadelhalter	227
Key Elevatorien	376	Kogan Endoskopula.....	359	Lichtwitz Trokare	283
Kielland Geburtszangen	366	König Führungshohlsonden	249	Ligatur- und Präparierklemmen	127-132,138,139
Kilner CT-ORO Nadelhalter	233	Konrich Sterilisierbehälter	479	Ligaturscheren	60
Kilner Scheren.....	43	Kontraktoren, Rippen-.....	334	Lister CT-ORO Verbandscheren	64
Kilner Wundhaken	160	Konusmesser, Fistelhaken.....	340	Lister-Exentric Verbandscheren	62
Kinder- und Neonatalklemmen Atraumatic	323-326	Kopfschwartzangen	367	Lister Korn-, Polypenzangen	148
Kirschner Bauchdeckenhalter	212,213	Korn-, Tupferzangen.....	148-151	Lister Supercut Scheren	73
Kirschner Extensionsbügel.....	436	Krampfader- Bestecke	263	Lister Verbandscheren	61
Kirschner Ferrozell Führungshohlsonden	248	Krause Trokare	283	Liston-Key Knochensplitterzangen.....	396
Kirschner Führungshohlsonden	247	Kristeller Scheidenhalter	353-355	Liston Knochensplitterzangen	394
Klammern, Sterilisier-	476	Kronecker Unterbindungsnadeln	243	Littauer Cilienpinzetten	110
Klammern, Wund-.....	251	Kuemmel Spatel	186	Littauer Ligaturscheren	60
Kleinert-Kutz Sehnenfassinstrumente.....	374	Küretten, Abortus-	368	Littler Ligaturscheren	60
Klemmen, Anastomosen-.....	448	Küretten, Absaug-	350	Lockhart-Mummery Sonden	262
Klemmen, Anastomosen-, Atraumatic.....	452,453	Küretten, Saug- und Biopsie-.....	347	Locklin CT-ORO Scheren.....	88
Klemmen, Arterien-.....	116-129,131-134,138,139	Küretten, Uterus-	348-350	Lockwood Gewebe- und Organfasszangen	255
		L		Löffel, Abortus-.....	368
		Lahey Arterien-, Bronchusklemmen	134	Löffel, Gallenstein-.....	469,470
				Löffel, Geburts-.....	368
				Löffel, Scharfe	401-406



Löffel, Sekret-	465	Mayo-Stille Scheren	65	Mini-Friedmann Hohlmeisselzangen.....	388
Löffel, Uterus-	348	Mayo-Stille Supercut Scheren	66	Mini-Gemini Präparierklemmen	130
Logan Wundsperrer	191	Mayo Supercut Scheren.....	66	Mini-Hohmann Knochenhebel.....	377
Lorenz Verbandscheren.....	62	Mc Donald Elevatorien.....	377	Mini-Lambotte Osteotome.....	413
Lorna Tuchklemmen	145	Mc Indoe Anatomische Pinzetten.....	95	Mini-Langenbeck Wundhaken	157
Loute Drahtspanninstrumente.....	435	Mc Indoe CT-ORO Pinzetten	97	Mini-Lexer Osteotome, Hohlmeissel.....	412
Lovelace Arterienklemmen	120	Mc Indoe Scheren.....	44	Mini-Roux Wundhaken	189
Lovelace Gewebe- und Organ- Fasszangen	257	Mc Intosh Laryngoskope	277	Mixer Arterienklemmen	127,132
Lower Arterien-, Gallenkanalklemmen.....	134	Mc Intosh Laryngoskopie- Bestecke.....	277	Mixer-Baby Präparier- und Ligaturklemmen.....	132
Lowman Knochenhalteklammern	381	Mc Intosh Laryngoskopie- Spatel	277	Mixer Gallenkanal-, Bronchusklemmen	133,134
Lucae Hämmer.....	428	Mc Quigg-Mixer Gallenkanalklemmen	134	Mixer Gallensteinzangen	463
Lucae Ohrpinzetten	112	Mead Hämmer.....	429	Mixer-O'Shaugnessy Arterienklemmen	133
Luer Hohlmeisselzangen.....	390	Mead Hohlmeisselzangen	389	Mock Gefäßspülkanülen	338
Luer-Koerte Gallensteinlöffel.....	469	Meatotome.....	465	Mod.CEATEC Watteträger	264
Lungenspatel	334	Meeker Arterien-, Präparier-, Ligaturklemmen	139	Mod.Martin Führungshohlsonden	247
		Mehrzweckschalen	483	Mod.Michel Wundklemmen	250
M		Meissel	407-416	Mod.Muenchen Biopsieküretten.....	347
Magen- und Darm- Nähapparate	458	Meissel und Osteotome.....	407-416	Mod.Tübingen Wundhaken	173
Magen- und Darmklemmen Atraumatic	449-452	Meissel, Sternum-.....	291	Mod.USA Scharfe Löffel	405
Magen- und Darmquetschklemmen	446	Meniskushaken	380	Mod.USA Scheren.....	49
Magenklemmen	447	Meniskusmesser	372	Mod.Wien Fadenfänger	249
Magill Katheterzangen	274	Merctgen (Retractor) Rippensperrer	333	Moeltgen Winkelmesser für die Gliedermassen	269
Maisonneuve Urethrotome	473	Messapparate, Blutdruck-.....	271	Mollison Wundsperrer	194
Markwalder Knochensplitterzangen	394	Messbecher	480	Moore Gallensteinlöffel	470
Marquardt Hohlmeisselzangen.....	391	Messer, Konus-.....	340	Moore Handbohrapparate	425
Martel Arterienklemmen	117	Messer, Meniskus-.....	372	Morris-De Bakey Atraumatic Cardiovascularklemmen...312	
Martin (Simpson) Uterussonden	350	Messer, Myom-.....	340	Morse-Favorolo Rippensperrer	330
Martin Bauchspatel	216	Messinstrumente	269,270	Mosquito-Dandy Arterienklemmen	120
Martin Beckenzirkel.....	369	Metall- Katheter	472	Moynihan Klemmzangen	142
Martin Knochenhaltezangen	382	Methot Wattespender.....	490	Museux Gewebe- und Organfasszangen	259
Martin Wundhaken	173	Metzenbaum CT-ORO Nadelhalter.....	239	Myom- und Konusmesser.....	340
Martini Scharfe Löffel.....	406	Metzenbaum CT-ORO Scheren	78,79,84	Myomheber	340
Mass.-General-Hospital Nadelhalter	223	Metzenbaum-Fino CT-ORO Scheren.....	82,83,85		
Masson CT-ORO Nadelhalter	235	Metzenbaum-Fino Supercut Scheren	67,68	N	
Masson Nadelhalter	224	Metzenbaum-Lahey CT-ORO Scheren	84	Nabatoff Krampfaderbestecke	263
Mastdarm- Biopsiezangen	454,455	Metzenbaum Nadelhalter	223	Nabelschnurklemmen	366
Mastdarm- Rektum- Spekulum	456	Metzenbaum-Nelson Präparierscheren	33-36	Nabelschnur- Scheren	49
Mathieu CT-ORO Nadelhalter	239	Metzenbaum-Nelson Supercut Präparierscheren	68	Nadel- Sterilisierkästchen	481,482
Mathieu Fremdkörperzangen.....	465	Metzenbaum Präparierscheren	31,32,37,40,41	Nadelhalter	222-227
Mathieu-Kocher CT-ORO Nadelhalter	239	Metzenbaum-S CT-ORO Scheren	80	Nadelhalter CT-ORO	231-240
Mathieu Mastdarm- Spekulum	456	Metzenbaum-Thorek CT-ORO Scheren	80	Nadelhalter, Mikro-	218-221
Mathieu Nadelhalter.....	226,227	Meyerding Wundhaken.....	157	Nadeln, Drahtumführungs-	435
Mathieu Scheidenhalter	356	Michel Wundklammerbesteck	251	Nadeln, Führungs-	287
Mathieu Scheidenspekula	356	Michel Wundklammern	251	Nadeln, Unterbindungs-	243-246
Mathieu Wundhaken	190	Michel Wundklammernpinzetten	250	Naegele Geburtszangen	366
Matson Raspatorien.....	422	Michel Wundklemmen	250	Nagelfeilen	493
Mayfield Hohlmeisselzangen	391	Micro-Adson Chirurgische Pinzetten.....	106	Nagelhautzangen.....	493
Mayo-Adams Bauchdeckenhalter.....	203	Micro-Adson CT-ORO Pinzetten.....	98	Nagelscheren	492
Mayo-Blake Gallensteinzangen	463	Microvascular CT-ORO Nadelhalter	238	Nagelzangen.....	492,493
Mayo CT-ORO Scheren	76	Middeldorp Wundhaken	167,171	Nähapparate	458
Mayo Gallensteinlöffel.....	470	Mikro- Nadelhalter	218-221	Naht- Instrumente	241,242
Mayo-Harrington CT-ORO Scheren.....	86	Mikro- Pinzetten	90,92	Nahtscheren CT-ORO	77
Mayo-Harrington Präparierscheren	25	Mikro- Scheren	54-58	Nasen- und Tonsillenscheren	47
Mayo-Hegar CT-ORO Nadelhalter.....	234	Mikulicz Peritoneumklemmen	143	Neff Meniskusmesser	372
Mayo-Hegar Nadelhalter.....	223,224	Mikulicz Wundhaken.....	184	Negus Arterienklemmen.....	139
Mayo-Hegar (Heaney) CT-ORO Nadelhalter.....	235	Miller-Baby Laryngoskopie- Bestecke	275	Neivert Nadelhalter	222
Mayo-Lexer CT-ORO Scheren	78,81	Miller Laryngoskope	275	Nélaton Sonden	262
Mayo-Noble Gynäkologische Scheren	28	Miller Laryngoskopie- Spatel.....	275	Nelson Chirurgische Pinzetten.....	108
Mayo Präparierscheren	24	Milligan Wundsperrer.....	195	Nelson Trokare.....	282
Mayo-Robson Atraumatic Darmklemmen	450	Millin Atraumatic Kapsel Fasszangen	464	Neonatal- und Kinderklemmen, Atraumatic	323-326
Mayo-Robson Darmklemmen	444	Millin Blasen- Wundspreizer	468	Neurochirurgische Scheren	46
Mayo-Russ , Chirurgische Pinzetten	108	Millin Blasenhalssperrer.....	467	Newman Proktoskope	457
Mayo Sterilisierklammern	476	Millin Prostatafasszangen	464	Nierenfistelzangen	463
Mayo-Stille CT-ORO Scheren	78	Mini-Adson Anatomische Pinzetten	95	Nierenschalen.....	488
Mayo-Stille Präparierscheren	26,27	Mini-Adson Chirurgische Pinzetten.....	106	Nierensteinzangen.....	462



Nierenstielklemmen	135,136	Pinzetten, Anatomische-.....	93-96	Reverdin Nadeln	241,242
Nierenstielklemmen, Atraumatic	135	Pinzetten, Atraumatic-.....	292	Reynolds Scheren	43
Nissen Gallenkanalklemmen	137	Pinzetten, Chirurgische	101-108	Reynolds Supercut Scheren.....	68
Northbent Ligaturscheren.....	60	Pinzetten, Cilien-.....	110,111	Ricard Bauchdeckenhalter.....	205
Noto Uterus- Polypenzangen	344	Pinzetten, CT-ORO.....	97-100	Richardson-Eastman Wundhaken.....	168
Novak Biopsieküretten	347	Pinzetten, Feine Modelle	109	Richardson Wundhaken.....	168
Nuboer Saugrohre	286	Pinzetten, Mikro-.....	90,92	Richter-Heath Wundklammern	250
Nussbaum Magenklammern.....	447	Pinzetten, Ohr-.....	112	Richter Inzisionsscheren.....	23
O		Pinzetten, Splitter-.....	110	Rippen- und Knochenscheren	290,291
Ochsner Atraumatic Cardiovascularklammern	297	Pinzetten, Tampon-.....	112	Rippenkontraktoren	334
Ochsner Trokare	282	Pinzetten, Tumor-.....	91	Rippensperrer.....	330-333
Ochsner Wundklammernpinzetten	250	Pinzetten, Uhrmacher-.....	107	Rippensperrer aus Leichtmetall.....	327-329
O'Connor Wundhaken	155	Pinzetten, Wundklammern-	250	Robb Intima Spatel.....	335
Oehler CT-ORO Pinzetten	99	Placentabecken	488	Roberts Arterienklammern	128
Ohrpinzetten	112	Plester Wundsperrerr	194	Rochard Bauchdeckenhalter	214
Olivercrona Hohlmeisselzangen	390	Polloson Wundhaken	179	Rochester-Carmalt Arterienklammern	121
Olivercrona Scheren	46	Polypenzangen.....	148-151	Roeder Tuchklammern	144
Ollier Wundhaken	162	Poole Saugrohre	285	Rogers Hysterektomieklammern, Atraumatic.....	141
Olsen-Hegar CT-ORO Nadelhalter	238	Poppen Saugrohre.....	283	Rogge Sterilisierzangen	476
Olsen-Hegar Nadelhalter	226	Potts (De Bakey) Atraumatic Cardiovascularklammern	304	Rohre, Saug-	283-286
Ombredanne Hämmer	432	Potts Atraumatic Cardiovascularklammern	304,305	Ross Wundhaken.....	178
Organ- und Gewebe- Fasszangen	254,255, 257,259	Potts-Smith Anatomische Pinzetten.....	96	Roux Wundhaken.....	188
Organ- und Gewebe- Fasszangen, Atraumatic	256,258	Potts-Smith Chirurgische Pinzetten	105	Rumel-Belmont Tourniquets.....	338
Organ- und Gewebe- Fasszangen,CT-ORO	256	Potts-Smith CT-ORO Pinzetten.....	99	Rumel Präparier- und Ligaturklammern	131
Organmesser	4	Potts-Smith Scheren	44,45	Runde Schalen	480
Osteotome	407-416	Potts-Smith Supercut Scheren.....	69	Ruskin Hohlmeisselzangen	391
Osteotome und Meissel.....	407-416	Pozzi Gewebe- und Organfasszangen.....	259	Ruskin-Liston Knochensplitterzangen	395
O'Sullivan-O'Connor Bauchdeckenhalter	211	Präparier- und Ligaturklammern	127-132,138,139	Russ,Modell Chirurgische Pinzetten	107
O'Sullivan-O'Connor Scheidelspekula	359	Präparierscheren	24-27,31-41	Ryder CT-ORO Nadelhalter	235
Otis Urethrotome	473	Pratt Hämorrhoidalklemmen	455,456	Ryder-Vascular CT-ORO Nadelhalter	236
Overholt-Geissendoerfer Präparierklammern	129	Presbyterian Tuchklammern.....	146	S	
Overholt-Mixter Präparier-, Ligaturklammern.....	128	Price-Thomas Bronchusklemmen	294	Sachse Meatotom	465
Overholt-S Arterienklammern	127	Proktoskope	457	Saenger Kopfschwanzzangen	367
P		Prostatafasszangen	464	Sägen, Fingerring-.....	441
Parametrium CT-ORO Scheren	86	Prostatafasszangen, Atraumatic.....	464	Salenius Meniskusmesser	372
Parker-Langenbeck Wundhaken	190	Prostatahaken.....	466	Salpingographen.....	363
Parker-Mott Wundhaken.....	189	Providence-Hospital Arterienklammern	119	Santulli Atraumatic Bulldogklammern	295
Parker Wundhaken	189	Prüf- und Messinstrumente.....	269	Sanvenero Scheren	42
Partsch Hämmer	429	Putti Raspeln.....	417	Sarot Arterienklammern	128
Partsch Osteotome	407,408	R		Sarot CT-ORO Nadelhalter	234
Payr-Baby Darmquetschklemmen	446	Rabiner Perkussionshämmer.....	266	Satinsky Scheren.....	44
Payr Darmquetschklemmen	446	Radolf Nagelzangen	441	Satinsky/De Bakey Atraumatic	
Payr Führungshohlsonden	249	Ragnell-Davis Wundhaken.....	158	Cardiovascularklammern	310
Péan Arterienklammern	122,125,126	Ragnell(Killner) CT-ORO Scheren	88	Satterlee Amputationssägen.....	427
Péan-Kocher Arterienklammern	125,126	Ralk Handbohrapparate	426	Sauerbruch Abfallzangen	498
Péan-Nippon Arterienklammern	123	Rampley Tupferzangen.....	151	Sauerbruch Hohlmeisselzangen	393
Pederson Scheidenspekula.....	352	Randall Biopsieküretten	347	Sauerbruch Nadel- Sterilisierkästchen	481
Peers-Bertram Tuchklammern.....	145	Randall Nierensteinzangen.....	462	Sauerbruch Rippenscheren.....	291
Penisklemmen	465	Rasierklingen	6	Sauerbruch Wundhaken.....	175,178
Penner Fingernagelextraktionszangen	441	Rasierklingenbrecher.....	6	Saugrohre.....	283-286
Pennington Organ- Gewebe- Fasszangen.....	257	Rasierklingenhalter	6	Scalp-Contour Wundsperrerr	192
Percy Retraktoren	381	Raspatorien	418-422	Schaedel Tuchklammern.....	144
Peritoneumklammern	143	Raspeln, Stössel	417	Schalen, runde.....	480
Perkussionshämmer	266	Recamier Uterus Küretten	349	Scharfe Löffel	401-406
Perthes Bohrinstrumente	423	Redon Führungsnadeln	287	Schede Scharfe Löffel.....	402
Pestalozza Abortusküretten.....	368	Reill Knochenhalte zangen	383	Scheibe Organfasszangen Atraumatic.....	258
Petz Magen- und Darm- Nähapparate	458	Reinigungsbürsten	497	Scheidenhalter.....	353-359
Pfrieme	423	Rektoskope.....	459	Scheidenspekula	351-359
Phaneuf Hysterektomieklammern	140	Rektum- und Anastomosenklemmen, Atraumatic.....	452,453	Scherbak Scheidenspekula	357
Philips Schraubendreher	433	Resano Rektumklammern Atraumatic.....	453	Scheren	16-87
Pierce Trokare.....	283	Resektions- uns Amputationssägen	427	Scheren für Herz- und Gefäßchirurgie	44,45
Pinard Stethoskope.....	267	Resektionsmesser	5	Scheren für Neurochirurgie.....	46
		Retraktoren	381	Scheren mit Hartmetalleinsätzen.....	74-87
		Reverdin Bauchspatel.....	216	Scheren, Chirurgische-.....	16-22



Scheren, CT-ORO	75-88	Sensibilitäts- Instrumente, Stethoskope	267	Standard Hohlmeisselzangen	388
Scheren, Darm-	59	Seyffert Scheidenspekula	352	Standard Scheren	16-21,65
Scheren, Episiotomie-	48	Seziermesser	3	Standard Skalpellgriffe	7,9
Scheren, feine Chirurgische	42,43,50-52	Shaaf Cilienpinzetten	110	Standard Supercut Scheren	66
Scheren, Gips-	69	Shea Feine Chirurgische Scheren	43	Standard Trokare	282
Scheren, Gynäkologische	28-30	Siebold Gynäkologische Scheren	30	Standgefäße	484
Scheren, High- Qualität-	69	Siebold Supercut Scheren	67	Stationsgefäße	487
Scheren, Knochen-	290	Siebschalen, Sterilisier-	489	Staud-Moore Hakenzangen	341
Scheren, Kronen-	53	Simon Fistelhaken	340	Stechbecken	488
Scheren, Ligatur-	60	Simon Scharfe Löffel	404	Steinmann Sehnenfassinstrumente	373
Scheren, Mikro-	54-58	Simon Uteruslöffel	348	Stellbrink Hohlmeisselzangen	388
Scheren, Nabelschnur-	49	Simon Wundhaken	173	Sterilisier- und Bereitschaftskästen	485
Scheren, Nagel-	492	Simpson-Braun Geburtszangen	366	Sterilisierbehälter	479,485
Scheren, Nasen-	47	Simpson Geburtszangen	366	Sterilisierkästchen, Nadel-	481,482
Scheren, Präparier-	24-27,31-41	Simpson-Luikart Geburtszangen	366	Sterilisierklammern	476
Scheren, Rippen-	290,291	Sims CT-ORO Scheren	86	Sterilisiersiebschalen	489
Scheren, Standard-	16-21,65,74	Sims Gynäkologische Scheren	29	Sterilisierzangen	476
Scheren, Sternum-	291	Sims-Maier Korn-, Tupferzangen	149	Sternummeissel	291
Scheren, Supercut-	66-73	Sims Mastdarm- Spekula	456	Sternumscheren	291
Scheren, Tonsillen-	47	Sims Scheidenspekula	353	Stethoskope	267,268
Scheren, Verband-	61-64	Sims Supercut Scheren	67	Stevens Supercut Scheren	69
Schimmelbusch Verbandstofftrommeln	479	Sims Uterus Küretten	349	Stevens Scheren	52
Schink Dermatome	13	Sims Uterus- Sonden	350	Stieglitz Splitterzangen	111
Schlauchroller	146	Single-Tuttle Chirurgische Pinzetten	108	Stille Anatomische Pinzetten	94
Schmid Gefäßsspülkanülen	338	Skalpelle, Anatomische-	2	Stille-Barraya Chirurgische Pinzetten	103
Schmieden-Dick Unterbindungsadeln	243	Skalpellgriffe	7-10	Stille Chirurgische Pinzetten	103
Schmieden Führungshohlsonden	248	Skalpellklingen	11,12	Stille Gipscheren	63
Schmieden-Payr Führungshohlsonden	248	Skene Hakenzangen	342	Stille Handbohrapparate	424
Schmieden-Taylor Dura- Scheren	46	Smillie Meniskussmesser	372	Stille Hohlmeisselzangen	392
Schmieden Unterbindungsadeln	243	Smillie Spinalhaken	380	Stille Knochen- und Rippencheren	290
Schmidt Arterienklemmen	121	Smith-Petersen Osteotome, Hohlmeissel	414,415	Stille-Liston Knochensplitterzangen	395
Schoemaker-Loth Ligaturscheren	60	Snitman Wundsperrer	192	Stille-Luer Hohlmeisselzangen	393
Schraubendreher	433	Somer Uterus- Fasszangen	344	Stille Meissel	409,410
Schröder Uteruslöffel	348	Sonden	262	Stille Nierenstillklemmen	136
Schroeder Gewebe- und Organfasszangen	259	Sonden, Gallenstein-	471	Stille-Ruskin Hohlmeisselzangen	392
Schroeder Hakenzangen	342	Sonden, Uterus-	350	Stockmann Penisklemmen	465
Schubert Uterus- Biopsiezangen	345	Spatel, Bauch-	186,187,216	Stone Chirurgische Pinzetten	103
Schuhmacher Nabelschnurscheren	49	Spatel, Darm-	186,187	Stone Darmklemmen	448
Schultze Salpingographen	363	Spatel, Intima	335	Stone Watt Darm (Anastomosen-) Klemmen	448
Schumacher Uterus- Biopsiezangen	346	Spatel, Laryngoskopie-	275-278	Stösseln, Raspel	417
Schwedisch- Pattern Scharfe Löffel	403	Spatel, Lungen-	334	Strabismusscheren	52
Schwenkschalen	483	Spekula, Endo-	359	Strandell-Stille Wundhaken	160
Scoville Laminektomiespreizer	215	Spekula, Mastdarm-	456	Stratte CT-ORO Nadelhalter	237
Scudder Darm- und Magenquetschklemmen	446	Spekula, Scheiden-	351-359	Stratte Nadelhalter	226
Scudder Darm- und Magenquetschklemmen, Atraumatic	451	Spencer Ligaturscheren	60	Strauss Penisklemmen	465
Sedillot Raspatorien	419	Spencer-Wells Arterienklemmen	116	Strauss Rektoskope	459
Segond-Landau Klemmzangen	142	Spender, Gaze-	490	Stripper, Sehnen-	438,439
Segond Myomesser	340	Spender, Watte-	490	Strully Neurochirurgische Scheren	46
Sehnenfassinstrumente	373,374	Sperrer, Rippen-	327-333	Subramanian-Miniature Neonatalklemmen	323
Sehnenstripper, Durchzugsinstrumente	438,439	Sperrer, Wund-	191-202	Subramanian Neonatal- und Kinderklemmen	323
Sekretlöffel	465	Spezial Tuckklemmen	146	Supercut Scheren	65-72
Sellheim Geburtslöffel	368	Sphinkteroskope, Anuskope	457		
Sellors Rippenkontraktoren	334	Spinalhaken	380		
Semb Bronchusklemmen	294	Spirituslampen	496	T	
Semb Hohlmeisselzangen	392	Splitterpinzetten	110	Tamponpinzetten	112
Semb Knochenhalte-zangen	385	Splitterzangen	111	Taylor Anatomische Pinzetten	95
Semb Knochensplitterzangen	396	Spratt scharfe Löffel	402	Taylor Chirurgische Pinzetten	104
Semb Raspatorien	422	Spreizer, Anal-	457	Taylor Mod.USA Perkussionshämmer	266
Semken Anatomische Pinzetten	95	Spreizer, Laminektomie-	215	Taylor Spinalhaken	380
Semken Chirurgische Pinzetten	104	Spülschalen	478	Teale Hakenzangen	342
Semken CT-ORO Pinzetten	97	St.Marks Wundhaken	185	Thoms-Allis Gewebe- und Organfasszangen	255
Semm Scheidenspekula	352	Stacke Sonden	262	Thoms-Gaylor Uterus- Biopsiezangen	345
Senn-Green Wundhaken	158	Standard Anatomische Pinzetten	93,94	Thomson-Walker Blasenwundsperrer	467
Senn-Mueller Wundhaken	158	Standard Arterienklemmen	116	Thorek Scheren für Gefäßchirurgie	44
		Standard Chirurgische Pinzetten	101	Titan- Atraumatic Bulldogklemmen	293
		Standard CT-ORO Scheren	75	Titan- Elevatorien	376



Toennis-Adson CT-ORO Scheren.....	84	Volkman Wundhaken.....	160,161	Young Nahtinstrumente	242
Toennis-Adson Scheren	46	Vollmar Endarterektomiestripper.....	264	Young Prostatahaken.....	466
Toennis Arterienklemmen	131	Vollmar Gefäßspülkanülen	338		
Toennis CT-ORO Nadelhalter.....	240				
Toennis Nadelhalter	227				
Toennis Scheren	46				
Tohoku Tuchklemmen.....	145	W		Z	
Tonsillen- und Nasenscheren	47	Wachenfeldt Wundklammernpinzetten	250	Zangen- Haken.....	341-343
Tornado Verbandscheren	63	Wagner Scheren	50	Zangen- Kappen-.....	484
Tourniquets	338	Wagner Supercut Scheren	71	Zangen, Abfall.....	498
Townley Schieblehre.....	269	Walb Organmesser.....	4	Zangen, Draht- CT-ORO.....	397,400
Träger, Watte-	264	Waldmann Scheren	48	Zangen, Fass-	398
Trélat Scheidenspekula.....	352	Waldmann Supercut Scheren.....	70	Zangen, Flach-.....	398,399
Troeltsch Tamponpinzetten.....	112	Wallich Abortuslöffel	368	Zangen, Fremdkörper.....	148
Troeltsch-Wilde Ohrpinzetten.....	112	Walter-Carmalt Splitterpinzetten	110	Zangen, Gallenstein-	463
Trokare.....	282,283	Walton Fingerringssägen	441	Zangen, Geburts-.....	366
Trotter Hohlmeisselzangen	390	Walton Kornzangen.....	148	Zangen, Gewebe- und Organ- Fass	254,255,257,259
Troutman-Cris Rasierklingenbrecher	6	Wangensteen Anatomische Pinzetten.....	96	Zangen, Hämorrhoidal-.....	455
Tubbs Aorta Dilatatoren	336	Wangensteen CT-ORO Pinzetten.....	100	Zangen, Hohlmeissel-.....	388-393
Tuchklemmen	144-146	Wangensteen Nadelhalter	225	Zangen, Katheter-.....	274
Tuffier Organ- Gewebe- Fasszangen.....	257	Wangenstein CT-ORO Nadelhalter	236	Zangen, Klemm-	140,142
Tuffier Rippensperre	332	Wartenberg Sensibilitäts- Instrumente.....	267	Zangen, Knochenhalte-	381-388
Tuffier Wundhaken.....	172	Waschschüsseln	478	Zangen, Knochesplitter-	394-396
Tumorpinzetten.....	91	Wasserstrahlreinigungspistole mit Aufsätzen	494	Zangen, Kopfschwarten-.....	367
Tupferzangen.....	148-151	Wassmund Wundhaken.....	162	Zangen, Korn-.....	148-151
Turnbull Nagelzangen	493	Watson-Cheyne Elevatorien	377	Zangen, Mastdarm- Biopsie-	454,455
		Wattespender.....	490	Zangen, Nagel-	492,493
		Watteträger	264	Zangen, Nagelhaut-	493
U		Waugh Anatomische Pinzetten	96	Zangen, Nierenfistel-	463
Uhrmacherpinzetten	107	Waugh Chirurgische Pinzetten	105	Zangen, Nierenstein-	462
Ulrich Knochenhalte-zangen.....	386	Weber Atraumatic Cardiovascular-klemmen	310	Zangen, Polypen-	148-151
Ulrich Korn-, Tupferzangen	148	Weber Sensibilitäts- Instrumente	267	Zangen, Splitter-	110,111
Universal CT-ORO Scheren	88	Webster CT-ORO Nadelhalter	233	Zangen, Sterilisier-.....	476
Universal Trokare	282	Webster Nadelhalter	222	Zangen, Tupfer-.....	148-151
Universal Verbandscheren	61	Wechselventile.....	206,207	Zangen, Uterus- Biopsie-.....	345,346
Unterbindungsnadeln	243-246	Weissbarth Scheidenspekula	357	Zangen, Uterus- Fass-.....	344
Urethrotome.....	473	Weitlaner-Baby Wundsperrerr	195	Zangen, Uterus- Polypen-.....	344
Uterus- Biopsiezangen	345,346	Weitlaner-Loktite Wundsperrerr	193	Zangen, Draht-Kneif-	398
Uterus- Depressoren	350	Weitlaner-Wullstein Wundsperrerr	194	Zenker Präparier- und Ligaturklemmen	132
Uterus- Dilatatoren	360-362	Weitlaner Wundsperrerr	192,193	Zenker Wundhaken.....	166
Uterus- Fasszangen	344	Wertheim-Cullen Vaginalklemmen	140	Zirkel, Becken-.....	369
Uterus- Polypenzangen	344	Wertheim Gynäkologische Scheren	28	Zweifel CT-ORO Nadelhalter	240
Uterusküretten.....	348-350	Wertheim Klemmzangen	140,142		
Uteruslöffel.....	348	Westcott Mikro- Scheren	54		
Uterussonden	350	Wickström Arterien-, Bronchusklemmen	133		
		Williams Gewebe- und Organfasszangen	255		
V		Williger Elevatorien	376		
Vaginalklemmen	140,142	Williger Hämmer	428		
Valleix Uterussonden	350	Williger Raspatorien	421		
Van Buren Dilatationbougies	472	Williger Scharfe Löffel.....	403,406		
Van Buren Knochenhalte-zangen	381	Winter Kopfschwartenzangen	367		
Van Doren Uterus- Biopsiezangen.....	345	Wullstein Saugrohre	284		
Veidenheimer Rektumklemmen Atraumatic	453	Wundhaken	154-185,188-190		
Venhaken Brom Wundhaken	160	Wundhaken, Titan.....	154		
Verbandscheren	61-64	Wundklammerbesteck	251		
Verbandscheren CT-ORO.....	63	Wundklammern.....	251		
Verbandstoffrommeln.....	479	Wundklammernpinzetten	250		
Verbrugge Knochenhalte-zangen	387	Wundklammernpinzetten	250		
Vernier Schieblehren.....	270	Wundsperrerr.....	191-202		
Vickers Hämmer	432	Wundsperrerr.....	191-202		
Vickers Low-Profile Wundsperrerr	201	Wundspreizer, Blasen-.....	467,468		
Vickers Wundsperrerr	201				
Virchow Hirnmesser	4	Y		Yankauer Saugrohre	284
Virchow Knorpelmesser.....	3	Yasargil Mikro- Pinzetten	90	Yasargil Saugrohre	284
Volkman Scharfe Löffel.....	401,402,405,406	Yasargil Saugrohre	284	Yeoman Mastdarm- Biopsiezangen	454

- A**
- Abdominal Retractors203-205,208-214
- Abdominal Spatulas186,187,216
- Abortion Scoops368
- Accumulator insert for battery handle,
rechangeable279
- Adlerkreutz** Tissue Forceps103
- Adson** Artery Forceps121,127
- Adson** Boring Instruments423
- Adson-Brown** Dissecting Forceps, CT-ORO98
- Adson-Brown** Tissue Forceps106
- Adson** Dissecting Forceps, CT-ORO98
- Adson** Dressing Forceps95
- Adson** Elevators375
- Adson** Needle Holders223
- Adson** Retractors193,196,198
- Adson** Suction Tubes283
- Adson** Tissue Forceps104
- Alan-Parks** Rectal Specula457
- Alcohol Burners496
- Alderdyce** Elevators377
- Alexander** Bone Chisels and Gouges408
- Alexander** Cervical Biopsy and Specimen Forceps346
- Alexander** Periosteal Raspatories422
- Allis-Adair** Tissue and Organ Holding Forceps254
- Allis** Tissue and Organ Holding Forceps254,255
- Allis** Tissue and
Organ Holding Forceps, Atraumatic258
- Allison** Lung Spatulas334
- Alm** Retractors191
- Aly** Sensibility Instruments267
- Amputating Saws427
- Anal** Retractors457
- Anastomosis Clamp Forceps448
- Anderson-Adson** Retractors192
- Anestophon Stethoscopes268
- Anoscopes457
- Aortic Dilators336
- Applicators, Cotton264
- Arruga** Micro Needle Holders218,221
- Arruga** Needle Holders, CT-ORO232
- Artery Forceps116-129,131-134,138,139
- Artery Forceps, Atraumatic297
- Asch** Secretion Scoops465
- Aspirating Curettes350
- Atraumatic Anastomosis Forceps452,453
- Atraumatic Bulldog Clamps115,295,296,302,303
- Atraumatic Bulldog Clamps, Titan293
- Atraumatic Cardiovascular Forceps297-301,304-326
- Atraumatic Hemostatic Forceps297
- Atraumatic Intestinal and
Stomach Clamp Forceps449-452
- Atraumatic Sigmoid Anastomosis Forceps452,453
- Atraumatic Tissue and Organ Holding Forceps256,258
- Atraumatic Tissue Forceps292
- Autopsy Knives3
- Auvard** Vaginal Specula and Retractors357
- Awls423
- Ayre** Cone Knives340
- B**
- Babcock** Atraumatic Tissue
and Organ Holding Forceps256
- Babcock** Tissue and Organ Holding Forceps, CT-ORO256
- Baby-Allis** Tissue and Organ Holding Forceps254
- Baby-Collin** Abdominal Retractors203
- Baby-Doyen** Intestinal Clamp Forceps444
- Baby-Metzenbaum** Scissors, Supercut67
- Baby-Mikulicz** Peritoneal Forceps143
- Baby-Mixer** Artery Forceps117
- Baby-Overholt** Artery Forceps119
- Baby-Roux** Retractors189
- Backhaus** Towel Forceps144
- Bailey-Baby** Rib Contractors334
- Bailey-Gibbon** Rib Contractors334
- Bailey** Rib Contractors334
- Bainbridge** Cardiovascular Forceps, Atraumatic306
- Bakes** Gall Duct Dilators471
- Balfour** Abdominal Retractor209,210
- Balfour-Baby** Abdominal Retractors209
- Balfour US-Type** Abdominal Retractors211
- Bandage Scissors60-62
- Bandage Scissors, CT-ORO63
- Barraquer** Cilia Forceps111
- Barraquer** Micro-Needle Holders218,219
- Barraquer** Needle Holders, CT-ORO232
- Braun** Vaginal Retractors Micro- Needle Holders218
- Barrett** Tenaculum Forceps341
- Basins, Triangular488
- Battery Handle for Larygoscopes279
- Beacham** Tenaculum Forceps341
- Beck** Cardiovascular Forceps, Atraumatic318,322
- Beckmann-Adson** Retractors199
- Beckmann-Eaton** Retractors199
- Beckmann** Retractors198
- Bed Pans488
- Beebee** Crown Scissors53
- Beer** Cilia Forceps111
- Bengolea** Artery Forceps124
- Bennett** Meniscus Retractors380
- Bergmann** Bandage Scissors63
- Bergmann** Mallets431
- Berliner** Percussion Hammers266
- Bernhard** Towel Forceps145
- Bertillon** Cephalometer269
- Beyer** Bone Rongeur Forceps391
- Biopsy Curettes347
- Bircher-Ganske** Bone Holding Forceps382
- Bircher** Menisectomy Knives372
- Birkett** Artery Forceps128
- Bladder Retractors468
- Blades, Exchangeable206,207
- Blake** Gall Stone Forceps463
- Blake** Uterine Curettes350
- Blood Pressure Manometers271
- Blount** Meniscus Retractors380
- Blumenthal** Bone Rongeur Forceps390
- Böhler** Bone Cutting Forceps395
- Böhler** Bone Rongeur Forceps391
- Böhler** Extensions Bows436
- Bone Chisels and Gouges407-416
- Bone Curettes401-406
- Bone Cutting Forceps394-396
- Bone Files434
- Bone Hand Drills424-426
- Bone Holding Clamps381
- Bone Holding Forceps381-388
- Bone Levers377-380
- Bone Rongeur Forceps388-393
- Bone Shears290
- Bone Wire Guides435
- Bonney** Dissecting Forceps, CT-ORO97
- Bonney** Tissue Forceps108
- Bougies, Dilating472
- Bowls, Kidney488
- Bowls, Round480
- Bowls, Solution478
- Bowls, Wash478
- Bows, Extensions436,437
- Boxes, Instrument486
- Boxes, Sterilizing479,485
- Boynton** Needle Holders227
- Boys-Allis** Tissue and Organ Holding Forceps254
- Bozemann-Douglas** Swab Forceps150
- Bozemann** Needle Holders, CT-ORO237
- Bozemann** Swab Forceps150
- Brain** Knives4
- Brand** Tendon Seizing Forceps373
- Braun-Stadler** Episiotomy Scissors48
- Braun-Stadler** Scissors, Supercut70
- Braun** Tenaculum Forceps341,343
- Braun** Uterine Depressors350
- Braun** Vaginal Retractors355
- Braun** Vaginal Speculas355
- Breisky** Pelvimeters369
- Breisky** Vaginal Specula358
- Bronchus and Gall Duct Clamps133,134
- Bronchus Forceps294
- Brophy** Tissue Forceps105
- Brophy(Sullivan)** Scissors43
- Brown** Needle Holders222
- Brunner** Ferrozell Ligature Conductors248
- Brunner** Intestinal and
Stomach Clamp Forceps, Atraumatic452
- Brunner** Ligature Conductors247
- Brunner** Retractors175-177
- Brunner** Sternum Scissors291
- Bruns** Bandage Scissors62
- Bruns** Bandage Scissors, CT-ORO64
- Bruns** Bone Curettes402,404
- Brush Dispensers477
- Brushes, Cleaning497
- Brushes, Nail477
- Buck** Ligature Scissors60
- Buck** Percussion Hammers266
- Bulldog Clamps114,115
- Bulldog Clamps, Atraumatic115,295,296,302,303
- Bulldog Clamps, Atraumatic, Titanium293
- Bunnell** Hand Drills426
- Bunnell** Tendon Strippers438,439
- Bunt** Safety Pins476
- Burford** Rib Spreaders from Aluminium329
- Busch** Umbilical Scissors49
- Byrd** Suction Tubes286
- C**
- Caliper269
- Cannulae, Vascular Irrigating338
- Cardiovascular Forceps, Atraumatic297-301,304-326
- Caroll** Finger Goniometer269
- Caroll** Tendon Seizing Forceps373
- Carrel** Artery Forceps116
- Cartilage Knives3
- Cases Sterilizing and Storing485
- Cases, Needle Sterilizing482
- Castanares** Scissors, Supercut73



Castaneda Neonatal and Pediatric Clamps	326	Collin Uterine Sound	350	Dartigues Uterine Elevating Forceps	344
Castaneda Rib Spreaders from Aluminium	329	Collin Vaginal Specula	351	Daubenspeck Bone Curettes	405
Castroviejo-Barraquer Micro Needle Holders	221	Conductors, Ligature	247-249	Davidson Retractors	174
Castroviejo-Fino Micro Needle Holders	220	Cone Knives	340	De Bakey (Glover) Cardiovascular Forceps, Atraumatic	317
Castroviejo Micro Needle Holders	219-221	Contractors, Rib	334	De Bakey (Potts-Smith) Scissors, CT-ORO	87
Castroviejo Needle Holders, CT-ORO	231,232	Converse Needle Holders, CT-ORO	233	De Bakey-Bahnson Cardiovascular Forceps, Atraumatic	313
Castroviejo Razor Blade Holders	6	Cooley Aortic Dilators	336	De Bakey Cardiovascular Forceps, Atraumatic	305-309,312,315,319
Castroviejo-Standard Micro Needle Holders	220	Cooley Cardiovascular Forceps, Atraumatic	301,320,321	De Bakey Carotis Bulldog Clamps, Atraumatic	295
Catheter Forceps	274	Cooley-Derra Cardiovascular Forceps, Atraumatic	322	De Bakey-Dietrich Bulldog Clamps, Atraumatic	115
Catheter Introducing Instruments	474	Cooley Rib Spreaders from Aluminium	327	De Bakey Dissecting Forceps, CT-ORO	100
Catheters, Metal	472	Cooley Suction Tubes	285	De Bakey-Mosquito Hemostatic Forceps, Atraumatic	297
Cephalometer	269	Cooley Tissue Forceps, Atraumatic	292	De Bakey Needle Holders, CT-ORO	235
Cervical Biopsy and Specimen Forceps	345,346	Cooley Vascular Dilators	337	De Bakey-Pean Hemostatic Forceps, Atraumatic	316
Chadwick Fine Operating Scissors	42	Cooper Ligature Needles	243	De Bakey-Rankin Hemostatic Forceps, Atraumatic	297
Chaput Tissue and Organ Holding Forceps	257	Coryllos Retractors	174	De Bakey Retractors	202
Charrière Amputating Saws	427	Cottle-Kazanjian Bone Cutting Forceps	394	De Bakey Rib Spreader	295
Cheatle Sterilizing Forceps	476	Cottle Mallets	429	De Bakey-Satinsky Bulldog Clamps, Atraumatic	295
Cheron Cotton Swab Forceps	150	Cottle Nasal Scissors	47	De Bakey Tissue Forceps, Atraumatic	292
Chevalier Rib Spreaders	332	Cottle Scissors, Supercut	70	De Bakey Vascular Dilators	337
Childe Clip Applying Forceps	250	Cotton Applicators	264	De Martel-Wolfson Anastomosis Clamps	448
Chisels, Bone and Gouges	407-416	Cotton Receptacles	487	Dean Scissors, CT-ORO	88
Chisels, Sternum	291	Cotton Swab Forceps	148-151	Dean Tonsil and Nasal Scissors	47
Cilia Forceps	110,111	Coupland Suction Tubes	286	Deaver Incision Scissors	23
Circumcision Instrument	474	Crafoord Artery Forceps	128	Deaver Retractors	181-183
Clamp Forceps	140,142	Crafoord Vascular Scissors	44	Déjerine Percussion Hammers	266
Clamp Forceps, Intestinal	444,445,448	Crafoord Retractors	178	Demel Bone Wire Guide	434
Clamp Forceps, Intestinal and Anastomosis	448	Crile Artery Forceps	120	Denis-Browne Abdominal Retractors	211
Clamp Forceps, Intestinal, Atraumatic	449-452	Crile-Murray Needle Holders	223	Depressors	350
Clamp Forceps, Kidney Pedicle	135,136	Crile Needle Holders	226	Derf Needle Holders	222
Clamp Forceps, Kidney Pedicle, Atraumatic	135	Crile-Rankin Artery Forceps	120	Derf Needle Holders, CT-ORO	233
Clamp Forceps, Stomach	447	Crile-Wood Needle Holders	223	Dermatomes	13
Clamp Forceps, Stomach, Atraumatic	449-452	Crile-Wood Needle Holders, CT-ORO	234	Derra Cardiovascular Forceps, Atraumatic	318
Clamps, Bone Holding	381	Crown Scissors	53	Deschamps Ligature Needles	244-246
Clamps, Bronchus and Gall Duct	133,134,294	Crushing Clamps	446	Desjardins Gall Duct Clamps	137
Clamps, Bulldog	114,115	CT-ORO Bandage Scissors	63	Desjardins Gall Stone Forceps	463
Clamps, Bulldog, Atraumatic	115,295,296,302,303	CT-ORO Dissecting Forceps	97-100	Desjardins Gall Stone Probes	471
Clamps, Bulldog, Atraumatic, Titanium	293	CT-ORO Flat Nose Pliers	399	Desjardins Gall Stone Scoops	469
Clamps, Crushing	446	CT-ORO Needle Holders	231-240	Desmarres Retractors	156
Clamps, Gall Duct	133,134,137	CT-ORO Scissors	74-87	Dieffenbach Bulldog Clamps	114
Clamps, Intestinal and Stomach	446	CT-ORO Tissue and Organ Holding Forceps	256	Dietrich Bulldog Clamps, Atraumatic	115
Clamps, Neonatal Atraumatic	323-326	CT-ORO Wire Cutting Pliers	397,400	Dietrich Cardiovascular Clamps, Atraumatic	297
Clamps, Pediatric Atraumatic	323-326	Curettes, Aspirating	350	Dietrich Needle Holders, CT-ORO	231
Clamps, Umbilical Cord	366	Curettes, Biopsy	347	Dietrich Vascular Scissors	45
Cleaning Brushes	497	Curettes, Bone	401-406	Dilating Bougies	472
Cleveland Bone Cutting Forceps	394	Curettes, Ovum	368	Dilators, Aorta	336
Cleveland Bone Rongeur Forceps	389	Curettes, Suction Biopsy	347	Dilators, Gall Duct	471
Clips, Wound	251	Curettes, Uterine	348-350	Dilators, Uterine Sets	360-362
Cloward Retractors	197	Cusco Vaginal Specula	351	Dilators, Vascular	337
Coller-Crile Artery Forceps	120	Cushing Dissecting Forceps, CT-ORO	98	Dingmann Bone Holding Forceps	382
Collier Needle Holders	222	Cushing Dressing Forceps	96	Dispensers, Gauze and Cotton	490
Collin Abdominal Retractors	203,204	Cushing Periosteal Raspatories	418	Dissecting and Ligature Forceps	127-132,138,139
Collin Bone and Rib Shears	290	Cushing Retractors	158,159	Dissecting Knives	2
Collin Clip Applying Forceps	250	Cushing-Taylor Dissecting Forceps, CT-ORO	98	Douglas Cilia Forceps	111
Collin Cotton Swab Forceps	149	Cushing Tissue Forceps	105	Douglas Trocars	283
Collin-Duval Tissue and Organ Holding Forceps	254	Cuticle Nippers	493	Doyen Atraumatic Intestinal and Stomach Clamp Forceps	449
Collin Dynamometer	269	Cuzzi Abortion Scoops	368	Doyen Gynecological Scissors	30
Collin-Hartmann Retractors	188	Czerny Rectal Specula	456	Doyen Intestinal Clamp Forceps	444
Collin-Landau Vaginal Specula	351	Czerny Tenaculum Forceps	343	Doyen Mallets	428
Collin-Loktite Abdominal Retractors	204	D		Doyen Myoma Screws	340
Collin Mallets	428	Dale Cardiovascular Forceps, Atraumatic	299	Doyen Periosteal Raspatories	421
Collin Pelvimeters	369	Dandy Artery Forceps	120	Doyen Probes	262
Collin Retractors	189	Dandy Scissors	46	Doyen Retractors	172
Collin Scalpel Handles	8	Dardik Cardiovascular Forceps, Atraumatic	298	Doyen-Stille Retractors	169
Collin Tissue and Organ Holding Forceps	257				
Collin Umbilical Cord Clamps	366				
Collin Uterine Elevating Forceps	344				

Guttman Secretion Scoops.....	465	Instruments, Boring.....	423	Kirschner Abdominal Retractors	212,213
Guyon Catheter- Introducing Instruments.....	474	Instruments, Catheter Introduction	474	Kirschner Extension Bows	436
Guyon Kidney Pedicle Clamp Forceps	135	Instruments, Examination	269	Kirschner Ferrozell Ligature Conductors.....	248
Guyon Kidney Pedicle Clamp Forceps, Atraumatic	135	Instruments, Measuring	269,270	Kirschner Ligature Conductors.....	247
Gynecological Scissors	28-30	Instruments, Nail.....	440,441	Kleinert-Kutz Tendon Seizing Forceps	374
		Instruments, Sensibility.....	267	Knapp Scissors.....	52
H		Instruments, Suture	241,242	Knives, Autopsy	3
Haberer Abdominal Spatulas	216	Instruments, Wire Twisting.....	435	Knives, Brain.....	4
Haemorrhoidal Forceps	455	Intestinal and Anastomosis Clamp Forceps.....	448	Knives, Cartilage.....	3
Haight Rib Spreaders.....	330	Intestinal and Stomach Clamp Forceps, Atraumatic... 452,453		Knives, Cone	340
Halle Bone Curettes	405	Intestinal and Stomach Clamps	446	Knives, Dissecting	2
Halsey Needle Holders	222	Intestinal and Stomach Suturing Apparatus.....	458	Knives, Meniscomomy.....	372
Halsey Needle Holders, CT-ORO	233	Intestinal Clamp Forceps	444,445,448	Knives, Myoma	340
Halsted-Mosquito Artery Forceps.....	117,118	Intestinal Spatulas	186,187	Knowles Bandage Forceps.....	62
Hammers, Percussion	266	Intestinal Suture.....	449-452	Knutson Urethrography Instruments	474
Handles, Scalpel.....	7-10	Intima Spatula and Dilators.....	335	Kocher Artery Forceps	122,125,126
Hands, Lead	440	Israel Retractors	163	Kocher Atraumatic Intestinal	
Hank Uterine Dilators	362	Ives-Fansler Anoscopes	457	and Stomach Clamp Forceps	450,451
Harken Cardiovascular Forceps, Atraumatic.....	311			Kocher Bladder Retractors	468
Harrington-Pemberton Retractors	180	J		Kocher Intestinal Clamp Forceps.....	445
Harrington Retractors	180	Jackson-Burrows Retractors	202	Kocher-Langenbeck Retractors.....	165
Hartmann Artery Forceps.....	117	Jackson Vaginal Specula.....	353	Kocher-Nippon Artery Forceps	123
Hartmann Bone Rongeur Forceps.....	389	Jacobs Bone Hand Drills	425	Kocher Retractors	161,167,172
Hayes Sigmoid Anastomosis Forceps, Atraumatic.....	452	Jacobs Bone Hand Drills	425	Koerte Abdominal and Intestinal Spatula	186
Heaney Clamp Forceps.....	140	Jacobs Tenauculum Forceps	343	Koerte Retractors	162
Heaney Needle Holders	224	Jacobson-Adson Artery Forceps	121	Kogan Endospecula	359
Hegar-Baumgartner Needle Holders	222	Jameson Scissors.....	46	König Ligature Conductors	249
Hegar-Baumgartner Needle Holders, CT-ORO	233	Jamison Needle Holders	224	Konrich Sterilizing Boxes.....	479
Hegar Needle Holders	224	Jansen Bone Rongeur Forceps	388,389	Krause Trocars.....	283
Hegar Needle Holders, CT-ORO.....	237	Jansen Ear Dressing Forceps	112	Kristeller Vaginal Specula and Retractors.....	353-355
Hegar Uterine Dilators	360,361	Jansen Retractors.....	191	Kronecker Ligature Needles.....	243
Hegar Vascular Needle Holders, CT-ORO	237	Jars	484	Kuemmel Spatulas	186
Hegenbarth Suture Clip Forceps	250	Johns-Hopkins Bulldog Clamps	114		
Heiss Artery Forceps.....	127	Johnson Needle Holders	225	L	
Hemostats.....	417	Jones-Speziell Towel Forceps.....	144	Lahey Gall Duct Clamps	134
Henley Retractors	195	Jones Towel Forceps	144	Lambert-Key Cardiovascular Forceps, Atraumatic.....	312
Hepp/Scheidel Micro Scissors.....	55,57	Joseph Fine Operating Scissors	42	Lambotte Bone Chisels	414
Hepp/Scheidel Needle Holders, CT-ORO	231	Judd-Allis Tissue and Organ Holding Forceps.....	254	Lambotte Bone Holding Forceps	385
Herrick Kidney Pedicle Clamp Forceps	136	Judd-Masson Bladder Retractors.....	467	Lambotte Periosteal Raspatories	422
Heymann Scissors, Supercut.....	70			Laminectomy Retractors.....	215
Heymann Tonsil and Nasal Scissors.....	47	K		Landau Vaginal Specula	358
Heywood-Smith Rectal Biopsy Specimen Forceps.....	455	Kader Spatulas.....	186	Lane Bone Holding Forceps.....	386
Hibbs Bone Chisels.....	415,416	Kallmorgen Vaginal Specula and Retractors.....	355	Lane Screw Drivers	433
High-Quality Scissors	65	Kalt Micro- Needle Holders	218	Lane Stomach Clamp Forceps	447
Hoer Periosteal Raspatories.....	418	Kane Umbilical Cord Clamps	366	Lane Tissue Forceps	108
Hohmann Bone Levers	378,379	Kaye Scissors, Supercut	73	Lane Towel Forceps	145
Hoke Bone Chisels.....	415	Kelly Artery Forceps.....	119,138	Lange Bandage Forceps	61
Holzbach Abdominal retractors.....	205	Kelly Operating Scissors.....	31	Lange Clip Applying Forceps	250
Hooks, Fistula	340	Kelly-Rankin Artery Forceps.....	119	Lange-Hohmann Bone Levers	379
Hösel Retractors	170	Kelly Retractors.....	168,184	Langenbeck Bone Holding Forceps	384
Hudson Hand Drills.....	424	Kelly Scissors, CT-ORO.....	88	Langenbeck Elevators.....	375
Hunt Micro- Forceps.....	90	Kelly Sphincteroscopes.....	457	Langenbeck Needle Holders, CT-ORO	240
Hunter Splitter Forceps	110	Kelly Uterine Polypus Forceps	344	Langenbeck Periosteal Raspatories.....	418,419
Husfeldt Cardiovascular Forceps, Atraumatic	300	Kern Bone Holding Forceps	385	Langenbeck Resection Saws	427
Hysterectomy Forceps	140,142	Keuorkian Biopsy Curettes	347	Langenbeck Retractors	164
Hysterectomy Forceps, Atraumatic.....	141	Keuorkian Cervical Biopsy and Specimen Forceps.....	346	Laryngoscope Sets.....	275-278
		Key Elevators, Titanium.....	376	Laryngoscope Spatulas	275-278
I		Kidney Bowls	488	Laryngoscopes	275-279
Incision Scissors	23	Kidney Pedicle Clamp Forceps.....	135,136	Lawrence Dissecting Forceps.....	139
Instrument Boxes	486	Kidney Pedicle Clamp Forceps, Atraumatic.....	135	Lead Hands	440
Instrument Storing Trays.....	483	Kidney Stone Forceps	462	Lebsche Sternum Chisels.....	291
Instrument, Circumcision	474	Kielland Obstetrical Forceps.....	366	Lees Cardiovascular Forceps, Atraumatic.....	311,312
Instrumentation for Hystero- Salpingography	363	Kilner Fine Operating Scissors	43	Legueu Abdominal Retractors	208
Instruments for Tendon Tunnel	438,439	Kilner Needle Holders, CT-ORO.....	233	Legueu Bladder Retractors	467,468
		Kilner Retractors	160	Leksell-Stille Bone Rongeur Forceps.....	392

Leland-Jones Cardiovascular Forceps, Atraumatic	306	Masson Needle Holders, CT-ORO	235	Micro-Adson Dissecting Forceps, CT-ORO	98
Lempert Bone Curettes	403	Mathieu Foreign Body Forceps	465	Micro-Adson Tissue Forceps	106
Lempert Bone Rongeur Forceps	389	Mathieu-Kocher Needle Holders, CT-ORO	239	Micro Forceps	90,92
Lerche Tissue Forceps	103	Mathieu Needle Holders	226,227	Micro Needle Holders	218-221
Lerliche Abdominal and Intestinal Spatula	187	Mathieu Needle Holders, CT-ORO	239	Micro Scissors	54-58
Lerliche Artery Forceps	119	Mathieu Rectal Specula	456	Microvascular Needle Holders, CT-ORO	238
Levers, Bone	377-380	Mathieu Retractors	190	Middeldorff Retractors	167,171
Lewin Bone Holding Forceps	383	Mathieu Vaginal Specula and Retractors	356	Mikulicz Peritoneal Forceps	143
Lexer-Baby Dissecting Scissors	39	Matson Periosteal Raspatories	422	Mikulicz Retractors	184
Lexer Bone Chisels	412,413	Mayfield Bone Rongeur Forceps	391	Miller-Baby Laryngoscope Sets	275
Lexer Dissecting Scissors	39	Mayo-Adams Abdominal Retractors	203	Miller Laryngoscope Set	275
Lexer-Fino Dissecting Scissors	40	Mayo-Blake Gall Stone Forceps	463	Miller Laryngoscope Spatula	275
Lexer Scissors, CT-ORO	81	Mayo Dissecting Scissors	24	Miller Laryngoscopes	275
Lexer Scissors, Supercut	68	Mayo Gall Stone Scoops	470	Milligan Retractors	195
Lichtenberg Needle Holders, CT-ORO	240	Mayo-Harrington Dissecting Scissors	25	Millin Bladder Neck Spreaders	467
Lichtenberg Needle Holders	227	Mayo-Harrington Scissors, CT-ORO	86	Millin Bladder Retractors	468
Lichtwitz Trocars	283	Mayo-Hegar (Heaney) Needle Holders, CT-ORO	235	Millin Capsule Forceps, Atraumatic	464
Ligature and Dissecting Forceps	127-132,138,139	Mayo-Hegar Needle Holders	223,224	Millin Prostate Holding Forceps	464
Ligature Catcher	249	Mayo-Hegar Needle Holders, CT-ORO	234	Mini-Adson Dressing Forceps	95
Ligature Conductors	247-249	Mayo-Lexer Scissors CT-ORO	78,81	Mini-Adson Tissue Forceps	106
Ligature Needles	243-246	Mayo-Noble Gynecological Scissors	28	Mini-Friedman Bone Rongeur Forceps	388
Ligature Scissors	60	Mayo-Robson Intestinal Clamp Forceps	444	Mini-Gemini Dissecting Forceps	130
Lister Bandage Scissors	61	Mayo-Robson Intestinal Clamp Forceps, Atraumatic	450	Mini-Hohmann Bone Levers	377
Lister Bandage Scissors, CT-ORO	64	Mayo-Russ , Tissue Forceps	108	Mini-Lambotte Bone Chisels	413
Lister Cotton Swab Forceps	148	Mayo Safety Pins	476	Mini-Langenbeck Retractors	157
Lister-Excentric Bandage Scissors	62	Mayo Scissors, CT-ORO	76	Mini-Lexer Bone Chisels and Gouges	412
Lister Scissors, Supercut	74	Mayo Scissors, Supercut	66	Mini-Roux Retractors	189
Liston Bone Cutting Forceps	394	Mayo-Stille Dissecting Scissors	26,27	Mixer Artery Forceps	127,132
Liston-Key Bone Cutting Forceps	396	Mayo-Stille Scissors, CT-ORO	78	Mixer-Baby Dissecting Forceps	132
Littauer Cilia Forceps	110	Mayo-Stille Scissors, High Quality	65	Mixer Gall Duct Clamps	133,134
Littauer Ligature Scissors	60	Mayo-Stille Scissors, Supercut	66	Mixer Gall Stone Forceps	463
Littler Scissors	60	Mc Donald Elevators	377	Mixer-O'Shaughnessy Artery Forceps	133
Lockhart-Mummery Probes	262	Mc Indoe Dissecting Forceps, CT-ORO	97	Mock Vessel Irrigating Cannulae	338
Locklin Scissors, CT-ORO	88	Mc Indoe Dressing Forceps	95	Mod.CEATEC Cotton Applicators	264
Lockwood Tissue and Organ Holding Forceps	255	Mc Indoe Scissors	44	Mod.Martin Ligature Conductors	247
Logan Retractors	191	Mc Intosh Laryngoscope Sets	277	Mod.Michel Clip Applying Forceps	250
Lorenz Bandage Scissors	62	Mc Intosh Laryngoscope Spatula	277	Mod.Muenchen Suction Biopsy Curettes	347
Lorna Towel Forceps	145	Mc Intosh Laryngoscopes	277	Mod.Tübingen Retractors	173
Loute Wire Twisting Instruments	435	Mc Quigg-Mixer Gall Duct Clamps	134	Mod.USA Bone Curettes	405
Lovelace Artery Forceps	120	Mead Bone Rongeur Forceps	389	Mod.USA Umbilical Scissors	49
Lovelace Tissue and Organ Holding Forceps	257	Mead Mallets	429	Mod.Wien Knot Tiers	249
Lower Gall Duct Clamps	134	Measures, Graduated	480	Moeltgen Goniometer (Flexometer)	269
Lowman Bone Holding Clamps	381	Measuring Instruments	269,270	Mollison Retractors	194
Lucae Ear Dressing Forceps	112	Meatotomes	465	Moore Gall Stone Scoops	470
Lucae Mallets	428	Meeker Dissecting Forceps	139	Moore Hand Drills	425
Luer Bone Rongeur Forceps	390	Meniscotomy Knives	372	Morris-De Bakey Cardiovascular Forceps, Atraumatic	312
Luer-Koerte Gall Stone Scoops	469	Meniscus Retractors	380	Morse-Favaloro Rib Spreaders from Aluminium	330
Lung Spatulas	334	Mercedes (Retractor) Rib Retractors	333	Mosquito-Dandy Artery Forceps	120
M		Metal Catheters	472	Moynihan Clamp Forceps	142
Magill Catheter Forceps	274	Method Gauze and Cotton Dispenser	490	Museux Tissue and Organ Holding Forceps	259
Maisonneuve Urethrotomes	473	Metzenbaum Dissecting Scissors	31,32,37,40,41	Myoma Instruments	340
Mallets	428-432	Metzenbaum-Fino Scissors, CT-ORO	82,83,85	N	
Manometers, Blood Pressure	271	Metzenbaum-Fino Scissors, Supercut	67,68	Nabatoff Varicose Vein Probe Sets	263
Markwalder Bone Cutting Forceps	394	Metzenbaum-Lahey Scissors, CT-ORO	84	Naegle Obstetrical Forceps	366
Marquardt Bone Rongeur Forceps	391	Metzenbaum Needle Holders	223	Nail Files	493
Martel Artery Forceps	117	Metzenbaum Needle Holders, CT-ORO	239	Nail Nippers	492,493
Martin (Simpson) Uterine Sound	350	Metzenbaum-Nelson Dissecting Scissors	33-36	Nail Scissors	492
Martin Abdominal Spatulas	216	Metzenbaum-Nelson Dissecting Scissors, Supercut	68	Nailbrushes	477
Martin Bone Curettes	406	Metzenbaum-S Scissors, CT-ORO	80	Nasal Scissors	47
Martin Bone Holding Forceps	382	Metzenbaum Scissors, CT-ORO	78,79,84	Needle Holders	222-227
Martin Pelvimeters	369	Metzenbaum-Thorek Scissors, CT-ORO	80	Needle Holders, CT-ORO	231-240
Martin Retractors	173	Meyerding Retractors	157	Needle Holders, Micro	218-221
Mass-General-Hospital Needle Holders	223	Michel Clip Applying Forceps	250	Needle Sterilizing Cases	481,482
Masson Needle Holders	224	Michel Suture Set	251	Needles, Guide	287

Needles, Ligature	243-246	Penner Nail Instruments.....	441	Rectoscopes	459
Neff Menisectomy Knives	372	Pennington Tissue and Organ Holding Forceps	257	Redon Guide Needles.....	287
Negus Artery Forceps	139	Percussion Hammers	266	Reill Bone Holding Forceps.....	383
Neivert Needle Holders	222	Percy Amputation Retractors	381	Resano Atraumatic Sigmoid Anastomosis Forceps	453
Nélaton Probes	262	Periosteal Raspatories	418-422	Resection Knives	5
Nelson Tissue Forceps	108	Peritoneal Clamp Forceps	143	Resection Saws	427
Nelson Trocars.....	282	Perthes Boring Instruments	423	Retractors.....	154-185,188-202,381
Neonatal and Pediatric Clamps, Atraumatic.....	323-326	Pestalozza Ovum Curettes	368	Retractors, Abdominal.....	203-205,208-214
Nephrostomy Forceps	463	Petz Stomach and Intestinal Suturing Apparatus	458	Retractors, Anal.....	457
Neurosurgical Scissors	46	Phaneuf Hysterectomy Forceps.....	140	Retractors, Bladder.....	467,468
Newmann Proctoscopes	457	Philips Screw Drivers.....	433	Retractors, Laminectomy.....	215
Nippers, Cuticle	493	Pierce Trocars.....	283	Retractors, Meniscus	380
Nippers, Nail	492,493	Pinard Stethoscopes.....	267	Retractors, Prostatic	466
Nissen Gall Duct Clamps	137	Pins, Safety.....	476	Retractors, Spinal	380
Northbent Ligature Scissors	60	Pistols, Water Jet (with Several Tips)	494	Retractors, Titanium.....	154
Noto Uterine Polypus Forceps	344	Placenta Pans.....	488	Retractors, Vaginal	353-359
Novak Suction Biopsy Curettes.....	347	Plaster- of - Paris Shears.....	63	Reverdin Abdominal Spatulas	216
Nuboer Suction Tubes	286	Plester Retractors	194	Reverdin Needles	241,242
Nussbaum Stomach Clamp Forceps.....	447	Pliers, Flat Nose	398,399	Reynolds Fine Operating Scissors	43
O					
Obstetrical Forceps.....	366	Pliers, Seizing.....	398	Reynolds Scissors, Supercut.....	68
Ochsner Cardiovascular Forceps, Atraumatic	297	Pliers, Wire Cutting, CT-ORO	397,400	Rib and Bone Shears.....	290,291
Ochsner Clip Applying Forceps	250	Polloson Retractors.....	179	Rib Contractors.....	334
Ochsner Trocars	282	Polypus and Dressing Forceps.....	148-151	Rib Spreaders.....	330-333
O'Connor Retractors.....	155	Poole Suction Tubes	285	Rib Spreaders from Aluminium	327-329
Oehler Dissecting Forceps, CT-ORO.....	99	Poppen Suction Tubes.....	283	Ricard Abdominal Retractors.....	205
Olivercrona Bone Rongeur Forceps.....	390	Post Mortem Knives.....	4	Richardson-Eastman Retractors	168
Olivercrona Neurosurgical Scissors	46	Potts (DeBaKey) Cardiovascular Forceps, Atraumatic	304	Richardson Retractors	168
Ollier Retractors	162	Potts Cardiovascular Forceps, Atraumatic.....	304,305	Richter-Heath Suture Clip Forceps	250
Olsen-Hegar Needle Holders.....	226	Potts-Smith Dissecting Forceps, CT-ORO.....	99	Richter Incision Scissors.....	23
Olsen-Hegar Needle Holders, CT-ORO	238	Potts-Smith Dressing Forceps	96	Robb Intima Spatula	335
Ombredanne Mallets	432	Potts-Smith Scissors, Supercut.....	69	Roberts Artery Forceps.....	128
Operating Scissors.....	16-22,24-27,31-41	Potts-Smith Tissue Forceps	105	Rochard Abdominal Retractors.....	214
Organ and Tissue Holding Forceps	254,255,257,259	Potts-Smith Vascular Scissors	44,45	Rochester-Carmalt Artery Forceps	121
Organ and Tissue Holding Forceps, Atraumatic	256,258	Pozzi Tissue and Organ Holding Forceps	259	Roeder Towel Forceps	144
Organ and Tissue Holding Forceps,CT-ORO	256	Pratt Haemorrhoidal Forceps	455,456	Rogers Atraumatic Hysterectomy Forceps	141
Osteotomes	407-416	Presbyterian Towel Forceps.....	146	Rogge Sterilizing Forceps	476
O'Sullivan-O'Connor Abdominal Retractors	211	Price-Thomas Bronchus Forceps.....	294	Ross Retractors	178
O'Sullivan-O'Connor Vaginal Specula.....	359	Probes, Gall Stone.....	262	Round Bowls.....	480
Otis Urethrotomes	473	Probes, Gall Stone.....	471	Roux Retractors	188
Overholt-Geissendoerfer Dissecting Forceps.....	129	Probes, Uterine.....	350	Rumel-Belmont Tourniquets.....	338
Overholt-Mixter Dissecting Forceps.....	128	Proctoscopes	457	Rumel Dissecting Forceps	131
Ovum Curettes.....	368	Prostata Holding Forceps	464	Ruskin Bone Rongeur Forceps.....	391
P					
Pans, Bed	488	Prostata Holding Forceps, Atraumatic	464	Ruskin-Liston Bone Cutting Forceps	395
Pans, Placenta.....	488	Prostatic Retractors	466	Russ.Modell Tissue Forceps	107
Parametrium Scissors, CT-ORO	86	Providence-Hospital Artery Forceps.....	119	Ryder Needle Holders, CT-ORO.....	235
Parker-Langenbeck Retractors.....	190	Putti Hemostats.....	417	Ryder Vascular Needle Holders, CT-ORO	236
Parker-Mott Retractors	189	R			
Parker Retractors	189	Rabiner Percussion Hammers	266	S	
Partsch Bone Chisels and Gouges.....	407,408	Radolf Instrument for nails	441	Sachse Meatotomes	465
Partsch Mallets	429	Ragnell (Killner) Scissors, CT-ORO.....	88	Saenger Scalp Flap Forceps.....	367
Payr-Baby Intestinal and Stomach Clamps	446	Ragnell-Davis Retractors	158	Safety Pins.....	476
Payr Intestinal and Stomach Clamps	446	Ralk Hand Drills.....	426	Salenius Menisectomy.....	372
Payr Ligature Conductors.....	249	Rampley Swab Forceps.....	151	Santulli Atraumatic Bulldog Clamps	295
Péan Artery Forceps.....	122,125,126	Randall Biopsy Curettes	347	Sanvenero Fine Operating Scissors	42
Péan-Kocher Artery Forceps	125,126	Randall Kidney Stone Forceps	462	Sarot Artery Forceps	128
Péan-Nippon Artery Forceps	123	Raspatories, Periosteal	418-422	Sarot Needle Holders, CT-ORO.....	234
Pederson Vaginal Specula.....	352	Razor Blade Breakers.....	6	Satinsky Cardiovascular Forceps, Atraumatic.....	310
Peers-Bertram Towel Forceps.....	145	Razor Blade Holders.....	6	Satinsky Vascular Scissors	44
Pelvimeters	369	Razor Blades	6	Satterlee Amputating Saws.....	427
Penis Seizing Forceps	465	Recamier Uterine Curettes	349	Sauerbruch Bone Rongeur Forceps.....	393
R					
Rabiner Percussion Hammers					
Radolf Instrument for nails					
Ragnell (Killner) Scissors, CT-ORO.....					
Ragnell-Davis Retractors					
Ralk Hand Drills.....					
Rampley Swab Forceps.....					
Randall Biopsy Curettes					
Randall Kidney Stone Forceps					
Raspatories, Periosteal					
Razor Blade Breakers.....					
Razor Blade Holders.....					
Razor Blades					
Recamier Uterine Curettes					
Receptacles, Cotton					
Rechargeable Accumulator insert for battery handle.....					
Rectal Biopsy Specimen Forceps.....					
Rectal Specula.....					
Rector Retractors.....					
Reverdin Abdominal Spatulas					
Reverdin Needles					
Reynolds Fine Operating Scissors					
Reynolds Scissors, Supercut.....					
Rib and Bone Shears.....					
Rib Contractors.....					
Rib Spreaders.....					
Rib Spreaders from Aluminium					
Ricard Abdominal Retractors.....					
Richardson-Eastman Retractors					
Richardson Retractors					
Richter-Heath Suture Clip Forceps					
Richter Incision Scissors.....					
Robb Intima Spatula					
Roberts Artery Forceps.....					
Rochard Abdominal Retractors.....					
Rochester-Carmalt Artery Forceps					
Roeder Towel Forceps					
Rogers Atraumatic Hysterectomy Forceps					
Rogge Sterilizing Forceps					
Ross Retractors					
Round Bowls.....					
Roux Retractors					
Rumel-Belmont Tourniquets.....					
Rumel Dissecting Forceps					
Ruskin Bone Rongeur Forceps.....					
Ruskin-Liston Bone Cutting Forceps					
Russ.Modell Tissue Forceps					
Ryder Needle Holders, CT-ORO.....					
Ryder Vascular Needle Holders, CT-ORO					

Scalp-Contour Retractors	192	Semken Dissecting Forceps, CT-ORO	97	Standard Scissors, CT-ORO	75
Scalp Flap Forceps	367	Semken Dressing Forceps	95	Standard Scissors, Supercut	66
Scalpel Blades	11,12	Semken Tissue Forceps	104	Standard Tissue Forceps	101
Scalpel Handles	7-10	Semm Vaginal Specula	352	Standard Trocars	282
Schaedel Towel Forceps	144	Senn-Green Retractors	158	Staude-Moore Tenaculum Forceps	341
Schede Bone Curettes	402	Senn-Mueller Retractors	158	Steinmann Tendon Grasping Forceps	373
Scheibe Organ Holding Forceps, Atraumatic	258	Sensibility Instruments	267	Stellbrink Bone Rongeur Forceps	388
Scherbak Vaginal Specula	357	Sets, Laryngoscope	275-278	Sterilizing and Storing Cases	479
Schimmelbusch Dressing Sterilizing Drums	479	Sets, Suture	251	Sterilizing Boxes	479,485
Schink Dermatomes	13	Sets, Varicose Vein Probe	263	Sterilizing Forceps	476,484
Schmid Vessel Irrigating Cannulae	338	Seyffert Vaginal Specula	352	Sterilizing Trays	489
Schmieden-Dick Ligature Needles	243	Shaaf Cilia Forceps	110	Sternum Chisels	291
Schmieden Ligature Conductors	248	Shea Fine Operating Scissors	43	Sternum Scissors	291
Schmieden Ligature Needles	243	Siebold Gynecological Scissors	30	Stethoscopes	267,268
Schmieden-Payr Ligature Conductors	248	Siebold Scissors, Supercut	67	Stevens Scissors, Supercut	69
Schmieden-Taylor Dura Scissors	46	Sigmoid Anastomosis Forceps, Atraumatic	452,453	Stevens Scissors	52
Schnidt Artery Forceps	121	Simon Bone Curettes	404	Stieglitz Splitter Forceps	111
Schoemaker-Loth Ligature Scissors	60	Simon Fistula Hooks	340	Stille-Barray Tissue Forceps	103
Schroeder Tenaculum Forceps	342	Simon Retractors	173	Stille Bone and Rib Shears	290
Schroeder Tissue and Organ Holding Forceps	259	Simon Uterine Scoops	348	Stille Bone Chisels and Gouges	409,410
Schroeder Uterine Scoops	348	Simpson-Braun Obstetrical Forceps	366	Stille Bone Rongeur Forceps	392
Schubert Cervical Biopsy and Specimen Forceps	345	Simpson-Luikart Obstetrical Forceps	366	Stille Dressing Forceps	94
Schuhmacher Umbilical Scissors	49	Simpson Obstetrical Forceps	366	Stille Hand Drills	424
Schultze Instrument for Hystero- Salpingography	363	Sims Gynecological Scissors	29	Stille-Kidney Pedicle Clamp Forceps	136
Schumacher Cervical Biopsy and Specimen Forceps	346	Sims-Maier Cotton Swab Forceps	149	Stille-Liston Bone Cutting Forceps	395
Schwedisch- Pattern Bone Curettes	403	Sims Rectal Specula	456	Stille-Luer Bone Rongeur Forceps	393
Scissors	16-88	Sims Scissors, CT-ORO	86	Stille Plaster- of- Paris Shears	63
Scissors for Cardiovascular Surgery	44,45	Sims Scissors, Supercut	67	Stille-Ruskin Bone Rongeur Forceps	392
Scissors, Bandage	61-64	Sims Uterine Curettes	349	Stille Tissue Forceps	103
Scissors, CT-ORO	75-88	Sims Uterine Sounds	350	Stockmann Penis Seizing Forceps	465
Scissors, Crown	53	Sims Vaginal Specula	353	Stomach and Intestinal Clamp Forceps, Atraumatic	449-452
Scissors, Enterotomy	59	Single-Tuttle Tissue Forceps	108	Stomach and Intestinal Clamps	446
Scissors, Episiotomy	48	Skene Tenaculum Forceps	342	Stomach and Intestinal Suturing Apparatus	458
Scissors, Fine Operating	42,43,50-52	Smilie Spinal Retractors	380	Stomach Clamp Forceps	447
Scissors, Gynecological	28-30	Smillie Menisectomy Knives	372	Stone Intestinal Clamp Forceps	448
Scissors, High- Quality	65	Smith-Petersen Bone Chisels and Gouges	414,415	Stone Tissue Forceps	103
Scissors, Ligature	60	Snitman Retractors	192	Stone-Watt Intestinal Clamp Forceps	448
Scissors, Micro	54-58	Solution Bowls	478	Storing Cases	485
Scissors, Nail	492	Somer Uterine Elevating Forceps	344	Storing Trays	483
Scissors, Neurosurgical	46	Spare Bulb for Laryngoscope Blades	279	Strabismus Scissors	52
Scissors, Operating	16-22,24-27,31-41	Spatula, Abdominal	186,187,216	Strandell-Stille Retractors	160
Scissors, Standard	16-21,66,75	Spatula, Intestinal	186,187	Stratte Needle Holders	226
Scissors, Sternum	291	Spatula, Intima	335	Stratte Needle Holders, CT-ORO	237
Scissors, Supercut	66-73	Spatula, Laryngoscope	275-278	Strauss Penis Seizing Forceps	465
Scissors, Tonsil and Nasal	47	Spatula, Lung	334	Strauss Rectoscope Sets	459
Scissors, Umbilical	49	Specula, Endo-	359	Strippers, Tendon	438,439
Scoops, Abortion	368	Specula, Rectal	456	Strully Neurosurgical Scissors	46
Scoops, Gall Stone	469,470	Specula, Vaginal	351-359	Subramanian-Miniature Cardiovascular Forceps	323
Scoops, Secretion	465	Spencer Ligature Scissors	59	Subramanian Neonatal and Pediatric Clamps	323
Scoops, Uterine	348-350	Spencer-Wells Artery Forceps	116	Suction Tubes	283-286
Scoville Laminectomy Retractors	215	Spezial Towel Forceps	146	Supercut Scissors	66-73
Screw Drivers	433	Sphincteroscopes	457	Suture Instruments	241,242
Scudder Intestinal and Stomach Clamp	446	Spinal Retractors	380	Suture Scissors, CT-ORO	76
Scudder Intestinal and Stomach Clamp, Atraumatic	451	Splitter Forceps	110,111	Suture Sets	251
Secretion Scoops	465	Spoons, Elevating	368	Suturing Apparatus, Intestinal and Stomach	458
Sedillot Periosteal Raspatories	419	Spratt Bone Curettes	402		
Segond-Landau Clamp Forceps	142	Spreaders, Bladder Neck	467		
Segond Myoma Knives	340	Spreaders, Rib	330-333		
Seizing Pliers	398	Spreaders, Rib, Aluminium	327-329		
Sellheim Elevating Spoons	368	St.Marks Retractors	185		
Sellers Rib Contractors	334	Stacke Probes	262		
Semb Bone Cutting Forceps	396	Standard Artery Forceps	116		
Semb Bone Holding Forceps	385	Standard Bone Rongeur Forceps	388		
Semb Bone Rongeur Forceps	392	Standard Dressing Forceps	93,94		
Semb Bronchus Forceps	294	Standard Operating Scissors	16-21,66		
Semb Periosteal Raspatories	422	Standard Scalpel Handles	7,9		

T

Tampon Forceps	112
Taylor Dressing Forceps	95
Taylor Mod.USA Percussion Hammers	266
Taylor Spinal Retractors	380
Taylor Tissue Forceps	104
Teale Tenaculum Forceps	342
Tenaculum Forceps	341-343
Tendon Seizing Instruments	373,374

Tendon Strippers.....	438,439
Tendon Tunnel Instruments	438,439
Tenotomy Scissors.....	52
Thomson-Allis Tissue and Organ Holding Forceps.....	255
Thoms-Gaylor Cervical Biopsy and Specimen Forceps.....	345
Thomson-Walker Bladder Retractors.....	467
Thorek Vascular Scissors	44
Tips for Water Jet Pistol.....	495
Tissue and Organ Holding Forceps	254,255,257,259
Tissue and Organ Holding Forceps, Atraumatic.....	256,258
Tissue and Organ Holding Forceps, CT-ORO	256
Tissue Forceps	101-108
Titanium Atraumatic Bulldog Clamps	293
Titanium Elevators	376
Toennis-Adson Neurosurgical Scissors	46
Toennis-Adson Scissors, CT-ORO	84
Toennis Artery Forceps.....	131
Toennis Needle Holders	227
Toennis Needle Holders, CT-ORO.....	240
Toennis Neurosurgical Scissors.....	46
Tohoku Towel Forceps.....	145
Tonsil and Nasal Scissors.....	47
Tornado Bandage Scissors.....	63
Tourniquets	338
Towel Forceps.....	144-146
Townley Caliper	269
Trays, Instrument Storing.....	483
Trays, Sterilizing	489
Trays, Universal	483
Trélat Vaginal Specula	352
Triangular Basins.....	488
Trocars.....	282,283
Troeltsch (Wilde) Ear Dressing Forceps	112
Troeltsch Tampon Forceps	112
Trotter Bone Rongeur Forceps	390
Troutman-Chris Razor Blade Holders.....	6
Tubbs Aortic Dilators.....	336
Tubes, Suction.....	283-286
Tuffier Retractor.....	172
Tuffier Rib Spreaders.....	332
Tuffier Tissue and Organ Holding Forceps	257
Tumor Forceps.....	91
Turnbull Nail Nippers	493
U	
Ulrich Bone Holding Forceps	386
Ulrich Cotton Swab Forceps	148
Umbilical Cord Clamps	366
Umbilical Scissors.....	49
Universal Bandage Scissors.....	61
Universal Scissors, CT-ORO	88
Universal Trays.....	483
Universal Trocars.....	282
Urethrotomes	473
Uterine Curettes	348-350
Uterine Depressors.....	350
Uterine Dilators.....	360-362
Uterine Elevating Forceps	344
Uterine Polypus Forceps	344
Uterine Scoops	348
Uterine Sounds.....	350
V	
Vaginal Forceps	140,142
Vaginal Retractors	353-359
Vaginal Specula	351-359
Valleix Uterine Sounds.....	350
Van Buren Bone Holding Forceps	381
Van Buren Dilating Bougies	472
Van Doren Cervical Biopsy and Specimen Forceps	345
Varicose Vein Probe Sets	263
Vascular Dilators.....	337
Veidenheimer Sigmoid Anastomosis Forceps, Atraumatic.....	453
Veinhooks	160
Verbrugge Bone Holding Forceps	387
Vernier Caliper	270
Vessel Irrigating Cannulae.....	338
Vickers Low-Profile Retractors	201
Vickers Mallets.....	432
Vickers Retractors	201
Virchow Brain Knives.....	4
Virchow Cartilage Knives.....	3
Volkman Bone Curettes.....	401,402,405,406
Volkman Retractors	160,161
Vollmar Endarterectomy Stripper	264
Vollmar Vascular Irrigating Cannulae.....	338
W	
Wachenfeldt Clip Applying Forceps.....	250
Wagner Fine Operating Scissors	50
Wagner Scissors, Supercut.....	71
Walb Post Mortem Knives	4
Waldmann Episiotomy Scissors.....	48
Waldmann Scissors, Supercut.....	70
Wallich Abortin Scoops	368
Walter-Carmalt Splitter Forceps	110
Walton Cotton Swab Forceps	148
Walton Finger Ring Saws.....	441
Wangensteen Dissecting Forceps, CT-ORO	100
Wangensteen Dressing Forceps	96
Wangensteen Needle Holders.....	225
Wangenstein Needle Holders, CT-ORO.....	236
Wartenberg Sensibility Instruments	267
Wash Bowls	478
Wassmund Retractors	162
Waste Buckets.....	498
Waste Forceps.....	498
Watchmaker's Forceps	107
Water Jet Pistols with Several Tips.....	494
Watson-Cheyne Elevators.....	377
Waugh Dressing Forceps.....	96
Waugh Tissue Forceps	105
Weber Cardiovascular Forceps, Atraumatic.....	310
Weber Sensibility Instrument.....	267
Webster Needle Holders.....	222
Webster Needle Holders, CT-ORO	233
Weissbarth Vaginal Specula and Retractors	357
Weitlaner-Baby Retractors	195
Weitlaner-Locktite Retractors	193
Weitlaner Retractors	192,193
Weitlaner-Wullstein Retractors.....	194
Wertheim Clamp Forceps	140,142
Wertheim-Cullen Vaginal Forceps.....	140
Wertheim Gynecological Scissors	28
Westcott Micro Scissors	54
Wickström Artery Forceps.....	133
Williams Tissue and Organ Holding Forceps.....	255
Williger Bone Curettes	403,406
Williger Elevators	376
Williger Mallets	428
Williger Periosteal Raspatories.....	421
Winter Scalp Flap Forceps.....	367
Wire Cutting Pliers	398,400
Wire Cutting Pliers, CT-ORO	397,400
Wire Twisting Instruments.....	435
Wound Clips	251
Wullstein Suction Tubes	284
Y	
Yankauer Suction Tubes	284
Yasargil Micro- Forceps.....	90
Yasargil Suction Tubes	284
Yeoman Rectal Biopsy Specimen Forceps.....	454
Young Prostatic Retractors	466
Young Suture Instruments	242
Z	
Zenker Dissecting Forceps	132
Zenker Retractors	166
Zweifel Needle Holders, CT-ORO	240

A		
Accumulatore ricaricabile	279	
Adlerkreutz Pinze chirurgiche a denti di topo	103	
Adson-Brown Pinze chirurgiche	106	
Adson-Brown Pinze per dissezione, CT- ORO	98	
Adson Divaricatori	193,196,198	
Adson Elevatori	375	
Adson Pinze anatomiche per dissezione	95	
Adson Pinze chirurgiche	104	
Adson Pinze emostatiche	121,127	
Adson Pinze per dissezione, CT-ORO	98	
Adson Portaghi	223	
Adson Strumenti per perforazione	423	
Adson Tubi d'aspirazione	283	
Aghi passafili	435	
Aghi per introduzione	287	
Aghi per legatura	243-246	
Agrafe	251	
Alan-Parks Divaricatori per l'ano	457	
Alderdyce Elevatori	377	
Alexander Periotomi	422	
Alexander Pinze tagliente per biopsia	346	
Alexander Scalpelli e Osteotomi	408	
Allis-Adair Pinze per afferrare tessuti ed organi	254	
Allis Atraumatic Pinze per afferrare tessuti ed organi	258	
Allis Pinze per afferrare tessuti ed organi	254,255	
Allison Spatole per polmone	334	
Alm Divaricatori	191	
Aly Strumenti per misurare la sensibilità	267	
Anderson-Adson Divaricatori	192	
Anestophon Stetoscopi	268	
Anoscopi	457	
Apparecchiature di sutura per gastro-intestinale	458	
Approssimatori costali	334	
Archi per estensione	436,437	
Arruga Micro- Portaghi	218,221	
Arruga Portaghi CT-ORO	232	
Asch Cucchiari per secrezione	465	
Astucci per laringoscopi	275-278	
Astucci per varici	263	
Atraumatic Pinze	292	
Atraumatic Pinze Bulldog	115,295,296,302,303	
Atraumatic Pinze Bulldog, titanio	293	
Atraumatic Pinze cardiovascolari	297-301,304-326	
Atraumatic Pinze emostatiche	297	
Atraumatic Pinze gastro- intestinali	449-452	
Atraumatic Pinze per afferrare tessuti ed organi	256,258	
Atraumatic Pinze per anastomosi	452,453	
Auward Specoli e Valve vaginali	357	
Ayre Bisturi per il cono d'attrazione	340	
B		
Babcock Atraumatic Pinze per afferrare tessuti ed organi	256	
Babcock Pinze per afferrare tessuto ed organi, CT-ORO	256	
Baby-Allis Pinze per afferrare tessuti ed organi	254	
Baby-Collin Divaricatori addominali	203	
Baby-Doyen Pinze intestinali	444	
Baby-Metzenbaum Forbici, Supercut	67	
Baby-Mikulicz Pinze per peritoneo	143	
Baby-Mixer Pinze emostatiche	117	
Baby-Overholt Pinze emostatiche	119	
Baby-Roux Divaricatori	189	
Bacinelle per placenta	488	
Bacinelle reniformi	488	
Bacinelle triangolari	488	
Bacinelle universali	483	
Backhaus Fissateli	144	
Bailey Approssimatori costali	334	
Bailey-Baby Approssimatori costali	334	
Bailey-Gibbon Approssimatori costali	334	
Bainbridge Pinze cardiovascolari Atraumatic	306	
Bakes Dilatatori per condotti biliari	471	
Balfour-Baby Divaricatori addominali	209	
Balfour Divaricatori addominali	209,210	
Balfour US-Type Divaricatori addominali	211	
Barraquer Micro- Portaghi	218,219	
Barraquer Pinze depilatorie	111	
Barraquer Portaghi CT-ORO	232	
Barraquer-Troutman Micro- Portaghi	218	
Barrett Pinze abbassare il collo dell'utero	341	
Beacham Pinze per abbassare il collo dell'utero	341	
Beck Pinze cardiovascolari, Atraumatic	318,322	
Beckmann-Adson Divaricatori	199	
Beckmann Divaricatori	198	
Beckmann-Eaton Divaricatori	199	
Beebee Forbici	53	
Beer Pinze depilatorie	111	
Bengolea Pinze emostatiche	124	
Bennett Elevatori per ossa	380	
Bergmann Forbici per bendaggi	63	
Bergmann Martelli	431	
Berliner Martelli percussori	266	
Bernhard Fissateli	145	
Bertillon Cefalometri	269	
Beyer Pinze- sgorbie	391	
Bicchieri graduati	480	
Bircher-Ganske Pinze per menisco e cartilagine	382	
Bircher Meniscotomi	372	
Birkett Pinze emostatiche	128	
Bisturi per dissezione	2	
Bisturi per fibromi	340	
Bisturi per il cono d'attrazione	340	
Blake Curette uterine e d'aspirazione	350	
Blake Pinze per calcoli biliari	463	
Blount Elevatori per ossa	380	
Blumenthal Pinze- sgorbie	390	
Böhler Archi per estensione	436	
Böhler Pinze- sgorbie	391	
Böhler Pinze tagliente per ossa	395	
Bonney Pinze chirurgiche	108	
Bonney Pinze chirurgiche, CT-ORO	97	
Boynton Portaghi	227	
Boys-Allis Pinze per afferrare tessuti ed organi	254	
Bozemann-Douglas Pinze per medicatura e polipi	150	
Bozemann Pinze per medicatura e polipi	150	
Bozemann Portaghi CT-ORO	237	
Brand Strumenti per afferrare tendini	373	
Braun Depressori uterini	350	
Braun Pinze per abbassare il collo dell'utero	341,343	
Braun Specoli e Valve vaginali	355	
Braun-Stadler Forbici per episiotomia	48	
Braun-Stadler Forbici, Supercut	70	
Breisky Pelvimetri	369	
Breisky Specoli e Valve vaginali	358	
Brophy Pinze chirurgiche	105	
Brophy(Sullivan) Forbici fine per chirurgia	43	
Brom Divaricatore	160	
Brown Portaghi	222	
Brunner Divaricatori	175-177	
Brunner Ferrozell Sonde conduttrici	248	
Brunner Forbici per sterno	291	
Brunner Pinze gastro- intestinali, Atraumatic	452	
Brunner Sonde conduttrici	247	
Bruns Curette tagliente	402,404	
Bruns Forbici per bendaggi	62	
Bruns Forbici per bendaggi, CT-ORO	64	
Buck Forbici per legature	60	
Buck Martelli percussori	266	
Bunnell Perforatori a mano	426	
Bunnell Scollatendini	438,439	
Bunt Spille di sicurezza	476	
Burford Divaricatori costali in alluminio	329	
Busch Forbici ombelicali	49	
Byrd Tubi d'aspirazione	286	
C		
Cacciaviti	433	
Candelette dilatatrici	472	
Canule vascolari per irrigazione	338	
Caroll Goniometri	269	
Caroll Strumenti per afferrare tendini	373	
Carrell Pinze emostatiche	116	
Castanares Forbici, Supercut	73	
Castaneda Divaricatori costali in alluminio	329	
Castaneda Pinze per neonati e bambini	326	
Castroviejo-Barraquer Micro- Portaghi	221	
Castroviejo-Fino Micro- Portaghi	220	
Castroviejo Micro- Portaghi	219-221	
Castroviejo Pinze per afferrare le lamette de rasoio	6	
Castroviejo Portaghi, CT-ORO	231,232	
Castroviejo Standard Micro- Portaghi	220	
Cesioie per apparecchi gessati	63	
Cestelli per la sterilizzazione	489	
Cestelli rotondi per sterilizzazione	479,485	
Chadwick Forbici fine per chirurgia	42	
Chaput Pinze per afferrare tessuti	257	
Charrière Seghe per amputazione e resezione	427	
Cheatle Pinze per sterilizzazione	476	
Cheron Pinze per tamponi	150	
Chevalier Divaricatori	332	
Childe Pinze per agraffe	250	
Cleveland Pinze- sgorbie	389	
Cleveland Pinze taglienti per ossa	394	
Cloward Divaricatori	197	
Collettori di rifiuti	498	
Coller-Crile Pinze emostatiche	120	
Collier Portaghi	222	
Collin Depressori uterini	350	
Collin Dinamometri graduati in libbre inglese	269	
Collin Divaricatori	189	
Collin Divaricatori addominali	203,204	
Collin-Duval Pinze per afferrare tessuti	254	
Collin Forbici per ossa e costole	290	
Collin-Hartmann Divaricatori	188	
Collin-Landau Specoli vaginali	351	
Collin-Loktite Divaricatori addominali	204	
Collin Manici per bisturi	8	
Collin Martelli	428	
Collin Pelvimetri	369	
Collin Pinze ombelicali	366	
Collin Pinze per afferrare l'utero	344	
Collin Pinze per afferrare tessuti	257	
Collin Pinze per agraffe	250	
Collin Pinze per tamponi	149	



Collin Specoli vaginali.....	351	De Bakey (Glover) Pinze cardiovascolari, Atraumatic.....	317	Doyen Pinze per polipi uterini.....	344
Coltelli per autopsia.....	3,4	De Bakey (Potts-Smith) Forbici, CT -ORO.....	87	Doyen Sonde.....	262
Coltelli per cartilagini.....	3	De Bakey-Bahnon Pinze cardiovascolari, Atraumatic.....	313	Doyen Specoli vaginali.....	356,357,359
Coltelli per il cervello.....	4	De Bakey Carotis Pinze Bulldog, Atraumatic.....	295	Doyen-Stille Divaricatori.....	169
Coltelli per resezione.....	5	De Bakey Dilatatori vascolari.....	337	Doyen Uncini per fistole.....	340
Converse Portaghi, CT-ORO.....	233	De Bakey Divaricatori.....	202	Duplay Pinze per abbassare il collo dell'utero.....	341
Cooley-Derra Pinze cardiovascolari, Atraumatic.....	322	De Bakey Divaricatori costali.....	331	Duplay Pinze per tamponi.....	148
Cooley Dilatatori vascolari.....	336,337	De Bakey Mosquito Pinze emostatiche, Atraumatic.....	297	Duplex Stetoscopi.....	268
Cooley Divaricatori.....	183	De Bakey-Pean Pinze cardiovascolari, Atraumatic.....	316	Durante Pinze chirurgiche.....	107
Cooley Divaricatori costali in alluminio.....	327	De Bakey-Satinsky Pinze cardiovascolari, Atraumatic.....	305-309, 312,315,319	Duval Pinze per afferrare tessuti ed organi.....	257
Cooley Pinze Atraumatic.....	292	De Bakey Pinze per dissezione, CT-ORO.....	100	Duval Pinze per afferrare tessuti ed organi, CT-ORO.....	256
Cooley Pinze cardiovascolari, Atraumatic.....	301,320,321	De Bakey Pinze, Atraumatic.....	292		
Cooley Tubi d'aspirazione.....	285	De Bakey Portaghi CT-ORO.....	235	E	
Cooper Aghi per legatura.....	243	De Bakey-Rankin Pinze emostatiche, Atraumatic.....	297	Echlin Pinze- sgorbie.....	392
Coryllos Divaricatori.....	174	De Bakey-Satinsky Pinze Bulldog, Atraumatic.....	295	Eiselsberg Forbici per legature.....	60
Costotomi.....	290,291	De Bakey-Dietrich Pinze Bulldog, Atraumatic.....	115	Elevatori.....	375,376
Cottle Forbici.....	47	Dean Forbici nasali.....	47	Elevatori per ossa.....	377-380
Cottle Forbici, Supercut.....	70	Dean Forbici, CT-ORO.....	88	Elliot Forcipi.....	366
Cottle Martelli.....	429	Deaver Divaricatori.....	181-183	Elsässer Pinze per nefrostomia.....	463
Cottle Pinze taglienti per ossa.....	394	Deaver Forbici per incisione.....	23	Endospecoli.....	359
Coupland Tubi d'aspirazione.....	286	Déjerine Martelli percussori.....	266	Engl.Mod. Fissateli.....	144
Crafoord Forbici.....	44	Demel Aghi passafili.....	434	Eppendorf Pinze taglienti per biopsia.....	364
Crafoord Pinze emostatiche.....	128	Denis-Browne Divaricatori addominali.....	211	Esmarch Forbici per bendaggi.....	61
Crawford Divaricatori.....	178	Depressori uterini.....	350		
Crile-Murray Portaghi.....	223	Derf Portaghi.....	222	F	
Crile Pinze emostatiche.....	120	Derf Portaghi CT-ORO.....	233	Farabeuf-Collin Periostotomi.....	419
Crile Portaghi.....	226	Dermatomi.....	13	Farabeuf Divaricatori.....	188
Crile-Rankin Pinze emostatiche.....	120	Derra Pinze cardiovascolari Atraumatic.....	318	Farabeuf-Lambotte Tenaglie per ossa.....	385
Crile-Wood Portaghi.....	223	Deschamps Aghi per legatura.....	244-246	Farabeuf Periostotomi.....	419
Crile-Wood Portaghi CT-ORO.....	234	Desjardins Cucchiari per calcoli biliari.....	469	Farabeuf Tenaglie per ossa.....	385
CT-ORO Forbici.....	74-87	Desjardins Pinze per bronchi e vie biliari.....	137	Farrell (Lathbury-Uebe) Portacotone.....	264
CT-ORO Forbici per bendaggi.....	63	Desjardins Pinze per calcoli biliari.....	463	Faure Pinze emostatiche.....	142
CT-ORO Pinze per afferrare tessuti ed organi.....	256	Desjardins Sonde per calcoli biliari.....	471	Faure Pinze per peritoneo.....	143
CT-ORO Pinze per dissezione.....	97-100	Desmarres Divaricatori.....	156	Faure Pinze taglienti per biopsia.....	345
CT-ORO Pinze torcifili.....	397,400	Dieffenbach Pinze Bulldog.....	114	Fehland Pinze Atrauma per anastomosi del retto.....	453
CT-ORO Portaghi.....	231-240	Dietrich Pinze Bulldog, Atraumatic.....	115	Feilchenfeld Pinze per schegge.....	110
CT-ORO Tenaglie piatte.....	399	Dietrich Forbici.....	45	Feldheim Strumenti per unghie.....	440
Cucchiari ostetrici.....	368	Dietrich Pinze cardiovascolari, Atraumatic.....	297	Fergusson Cucchiari per calcoli biliari.....	470
Cucchiari per aborto.....	368	Dietrich Portaghi CT-ORO.....	231	Fergusson Tenaglie per ossa.....	384
Cucchiari per calcoli biliari.....	469,470	Dilatatori per condotti biliari.....	471	Fergusson Tubi d'aspirazione.....	283
Cucchiari per secrezione.....	465	Dilatatori uterini.....	360-362	Ferris-Smith Pinze chirurgiche.....	108
Curette d'aspirazione.....	350	Dilatatori vascolari.....	336,337	Ferrozell Sonde conduttrici.....	248
Curette per aborto.....	368	Dingmann Tenaglie per ossa.....	382	Finocchietto (modif.) Divaricatori costali	
Curette per biopsia.....	347	Distributori di spazzole.....	477	in alluminio.....	330
Curette taglienti.....	401-406	Distributori per garza,polvere ed ovatta.....	490	Finocchietto-Baby Divaricatori costali.....	333
Curette uterine.....	348-350	Divaricatori.....	154-185,188-202	Finocchietto-Baby-Haight Divaricatori costali	
Cusco Specoli vaginali.....	351	Divaricatori addominali.....	203-205,208-214	in alluminio.....	328
Cushing Divaricatori.....	158,159	Divaricatori costali.....	330-333	Finocchietto Divaricatori costali.....	333
Cushing Periostotomi.....	418	Divaricatori costali in alluminio.....	327-329	Finocchietto Divaricatori costali in alluminio.....	328
Cushing Pinze anatomiche per dissezione.....	96	Divaricatori in titanio.....	154	Finocchietto Pinze per vie biliari.....	134
Cushing Pinze chirurgiche.....	105	Divaricatori per il menisco.....	380	Finocchietto Portaghi.....	225
Cushing Pinze per dissezione, CT- ORO.....	98	Divaricatori per laminectomia.....	215	Finocchietto Portaghi CT-ORO.....	236
Cushing-Taylor Pinze per dissezione, CT-ORO.....	98	Divaricatori per l'ano.....	457	Finsen Divaricatori.....	191
Cuzzi Curette per aborto.....	368	Divaricatori prostatici.....	466	Finsen Mod.Martin Divaricatori.....	191
Czerny Pinze per abbassare il collo dell'utero.....	343	Divaricatori spinali.....	380	Fischer Scollatendini.....	439
Czerny Specoli rettali.....	456	Divaricatori vescicali.....	467,468	Fissateli (Pinze per fissare le compresse).....	144-146
		Douglas Pinze depilatorie.....	111	Foerster Divaricatori addominali.....	213
D		Douglas Trequarti.....	283	Foerster Pinze per tamponi.....	151
Dale Pinze cardiovascolari, Atraumatic.....	299	Doyen Divaricatori.....	172	Fomon Forbici.....	47
Dandy Forbici.....	46	Doyen Fissateli.....	145	Fomon Forbici, Supercut.....	70
Dandy Pinze emostatiche.....	120	Doyen Forbici per ginecologia.....	30	Forbici.....	16-87
Dardik Pinze cardiovascolari, Atraumatic.....	298	Doyen Martelli.....	428	Forbici a corona.....	53
Dartigues Pinze per afferrare l'utero.....	344	Doyen Periostotomi.....	421	Forbici fine per chirurgia.....	42,43,50-52
Daubenspeck Curette taglienti.....	405	Doyen Pinze gastro- intestinali, Atraumatic.....	449	Forbici nasali.....	47
Davidson Divaricatori.....	174	Doyen Pinze intestinali.....	444		

Forbici ombelicali	49	Gomel Forbici micro	55	Hoke Scalpelli e Osteotomi	415
Forbici per bendaggi	61-63	Gomel Pinze per tumori	91	Holzbach Divaricatori addominali	205
Forbici per bendaggi, CT-ORO	64	Good Forbici per tonsille	47	Hösel Divaricatori	170
Forbici per chirurgia	16-22	Gorney Forbici per dissezione	38	Hudson Perforatori a mano	424
Forbici per costole	290,291	Gorney Forbici, Supercut	72,73	Hunt Micro- Pinze	90
Forbici per dissezione	24-27,31-41	Gosset Divaricatori addominali	208	Hunter Pinze per schegge	110
Forbici per enterotomia	59	Gourdet Curette uterine	348	Husfeldt Pinze cardiovascolari, Atraumatic	300
Forbici per enucleazione	52	Graefe Divaricatori	155		
Forbici per episiotomia	48	Graefe Forbici fine per chirurgia	51	I	
Forbici per ginecologia	28-30	Grave Specoli vaginali	352	Iowa Pinze per abbassare il collo dell'utero	342
Forbici per incisione	23	Gray Pinze per vie biliari	137	Israel Divaricatori	163
Forbici per la chirurgia cardiovascolare	44,45	Grazil Forbici fine per chirurgia	52	Isterometri uterini	350
Forbici per legature	60	Grazil Forbici per chirurgia	22	Ives-Fansler Anoscopi	457
Forbici per neurochirurgia	46	Green-Armytage Pinze per cuoio capelluto	367		
Forbici per ossa	290	Greene Curette uterine	348	J	
Forbici per preparazione	24-27,31-41	Gregory Pinze cardiovascolari, Atraumatic	299	Jackson-Burrows Divaricatori	202
Forbici per sterno	291	Gregory-Soft Pinze Bulldog, Atraumatic	296	Jackson Specoli vaginali	353
Forbici per strabismo	52	Gross-Maier Pinze per medicature e tamponi	149	Jacobs Perforatori	425
Forbici per sutura, CT-ORO	77	Gruenwald-Jansen Pinze per medicature	112	Jacobs Pinze per abbassare il collo dell'utero	343
Forbici per tenotomia	52	Gruenwald Pinze per dissezione, CT-ORO	99	Jacobson-Adson Pinze emostatiche	121
Forbici per tonsille	47	Guedel-Negus Laringoscopi	276	Jameson Forbici per neurochirurgia	46
Forbici per unghie	492	Guedel-Negus Set per laringoscopia	276	Jamison Portaghi	224
Forbici, Alta-Qualità	65	Guedel Spatole per laringoscopia	276	Jansen Divaricatori	191
Forbici, CT-ORO	75-88	Gunnar-Hey Pinza presa-tubi con rulli	146	Jansen Pinze per orecchio	112
Forbici, Micro	54-58	Guthrie Divaricatori	155	Jansen Pinze sgorbie	388,389
Forbici, Standard	16-21,66,75	Guttmann Cucchiali per secrezione	465	Javid Pinze cardiovascolari, Atraumatic	300
Forbici, Supercut	66-73	Guyon Mandrini per sonde uretrali	474	Johns-Hopkins Pinze Bulldog	114
Forcipi	366	Guyon Pinze per peduncoli renali	135	Johnson Portaghi	225
Ford Stetoscopi	268	Guyon Pinze per peduncoli renali, Atraumatic	135	Jones Fissateli	144
Foregger Laringoscopi	278			Jones-Speziell Fissateli	144
Foregger Set per laringoscopia	278	H		Joseph Forbici fine per chirurgia	42
Foregger Spatole per laringoscopia	278	Haberer Spatole addominali	216	Judd-Allis Pinze per afferrare tessuti ed organi	254
Franz Divaricatori addominali	212	Haight Divaricatori costali	330	Judd-Masson Divaricatori vescicali	467
Frazier Tubi d'aspirazione	283	Halle Curette tagliente	405		
Freemann Forbici, Supercut	72	Halsey Portaghi	222	K	
Freemann-Gorney Forbici, Supercut	72	Halsey Portaghi, CT-ORO	233	Kader Spatole	186
Freemann-Kaye Forbici, Supercut	72	Halsted-Mosquito Pinze emostatiche	117,118	Kallmorgen Specoli e Valve vaginali	355
Friedmann Pinze- sgorbie	388	Hank Dilatatori uterini	362	Kalt Micro- Portaghi	218
Fritsch Divaricatori	171	Harken Pinze cardiovascolari, Atraumatic	311	Kane Pinze ombelicali	366
Frosch Tenaglie per ossa	384	Harrington Divaricatori	180	Kaye Forbici, Supercut	73
Frykholm Pinze- sgorbie	393	Harrington-Pemberton Divaricatori	180	Kelly Divaricatori	168,184
Fuchs Pinze emostatiche	121	Hartmann Pinze emostatiche	117	Kelly Forbici per chirurgia	31
		Hartmann Pinze- sgorbie	389	Kelly Forbici, CT-ORO	88
G		Hayes Pinze emostatiche per il retto, Atraumatic	452	Kelly Pinze emostatiche	119,138
Garrett Dilatatori vascolari	337	Heaney Pinze emostatiche	140	Kelly Pinze per polipi uterini	344
Gellhorn Pinze taglienti per biopsia	345	Heaney Portaghi	224	Kelly-Rankin Pinze emostatiche	119
Gelpi-Loktite Divaricatori	202	Hegar-Baumgartner Portaghi	222	Kelly Sfinteroscopi	457
Gemini Pinze per preparazione e legature	130	Hegar-Baumgartner Portaghi, CT-ORO	233	Kern Tenaglie per ossa	385
Gerald Pinze anatomiche per dissezione	94	Hegar Dilatatori uterini	360,361	Kevorkian Curette per biopsia	347
Gerald Pinze chirurgiche	105	Hegar Portaghi	224	Kevorkian Pinze taglienti per biopsia	346
Gerald Pinze per dissezione, CT-ORO	97	Hegar Portaghi, CT-ORO	237	Key Elevatori	376
Giertz-Stille Costotomi	291	Hegar Vascular Portaghi, CT-ORO	237	Kielland Forcipi	366
Gil-Vernet Divaricatori	159	Hegenbarth Pinze per agraiffe	250	Kilner Divaricatori	160
Gillies Divaricatori	160	Heiss Pinze emostatiche	127	Kilner Forbici fine per chirurgia	43
Gillies-Mini Portaghi, CT-ORO	238	Henley Divaricatori	195	Kilner Portaghi, CT-ORO	233
Gillies Pinze chirurgiche	104	Hepp/Scheidel Forbici Micro	55,57	Kirschner Archi per estensione	436
Gillies Pinze per dissezione, CT-ORO	97	Hepp/Scheidel Portaghi, CT-ORO	231	Kirschner Divaricatori addominali	212,213
Gillies Portaghi	226	Herrick Pinze per peduncoli renali	136	Kirschner Ferrozell Sonde conduttrici	248
Gillies Portaghi, CT-ORO	238	Heymann Forbici per il naso e tonsille	47	Kirschner Sonde conduttrici	247
Glover Pinze Bulldog, Atraumatic	295,303	Heymann Forbici, Supercut	70	Kleinert-Kutz Strumenti per afferrare tendini	374
Gluck Costotomi	290	Heywood-Smith Pinze taglienti per biopsia rettale	455	Knapp Forbici fine per chirurgia	52
Gluck Pinze per ossa e costole	290	Hibbs Scalpelli e Osteotomi	415,416	Knowles Forbici per bendaggi	62
Goelet Divaricatori	190	Hoenn Periostotomi	418	Knutson Strumenti per uretrografia	474
Goldmann-Fox Forbici, CT-ORO	87	Hohmann Elevatori per ossa	378,379		
Goldmann-Fox Forbici fine per chirurgia	50				



Kocher Divaricatori	161,167,172	Lichtwitz Trequarti	283	Mayo Forbici, Supercut	66
Kocher Divaricatori vescicali	468	Lime per ossa	434	Mayo-Harrington Forbici per dissezione	25
Kocher-Langenbeck Divaricatori	165	Lime per unghie	493	Mayo-Harrington Forbici, CT-ORO	86
Kocher-Nippon Pinze emostatiche	123	Lister-Excentric Forbici per bendaggi	62	Mayo-Hegar (Heaney) Portaghi, CT-ORO	235
Kocher Pinze emostatiche	122,125,126	Lister Forbici per bendaggi	61	Mayo-Hegar Portaghi	223,224
Kocher Pinze gastro- intestinali, Atraumatic	450,451	Lister Forbici per bendaggi, CT-ORO	64	Mayo-Hegar Portaghi, CT-ORO	234
Kocher Pinze intestinali	445	Lister Forbici, CT-ORO	87	Mayo-Lexer Forbici, CT-ORO	78,81
Koerte Divaricatori	162	Lister Forbici, Supercut	73	Mayo-Noble Forbici per ginecologia	28
Koerte Spatole addominali e intestinali	186	Lister Pinze per medicature e polipi	148	Mayo-Robson Pinze gastro- intestinali, Atraumatic	450
Kogan Endospecoli	359	Liston-Key Pinze taglienti per ossa	396	Mayo-Robson Pinze intestinali	444
König Sonde conduttrici	249	Liston Pinze taglienti per ossa	394	Mayo-Russ. Pinze chirurgiche	108
Konrich Scatole per sterilizzazione	479	Littauer Forbici per legature	60	Mayo Spille di sicurezza	476
Krause Trequarti	283	Littauer Pinze depilatorie	110	Mayo-Stille Forbici Alta-Qualità	65
Kristeller Specoli e Valve vaginali	353-355	Littler Forbici per legatura	60	Mayo-Stille Forbici per dissezione	26,27
Kronecker Aghi per legatura	243	Lockhart-Mummery Sonde per fistole	262	Mayo-Stille Forbici, CT-ORO	78
Kuemmel Spatole	186	Locklin Forbici, CT-ORO	88	Mayo-Stille Forbici, Supercut	66
L		Lockwood Pinze per afferrare il tessuto ed organi	255	Mc Donald Elevatori	377
Lahey Pinze per bronchi e vie biliari	134	Logan Divaricatori	191	Mc Indoe Forbici per la chirurgia cardiovascolare	44
Lambert-Kay Pinze cardiovascolari, Atraumatic	312	Lorenz Forbici per bendaggi	62	Mc Indoe Pinze anatomiche per dissezione	95
Lambotte Periostotomi	422	Lorna Fissateli	145	Mc Indoe Pinze per dissezione, CT-ORO	97
Lambotte Scalpelli ed Osteotomi	414	Loute Strumenti tendifilii	435	Mc Intosh Laringoscopi	277
Lambotte Tenaglie per ossa	385	Lovelace Pinze emostatiche	120	Mc Intosh Set per laringoscopia	277
Lame per bisturi	11,12	Lovelace Pinze per afferrare il tessuto ed organi	257	Mc Intosh Spatole per laringoscopia	277
Lamette da rasoio	6	Lower Pinze emostatiche	134	Mc Quigg-Mixter Pinze per vie biliari	134
Lampade a spirito	496	Lowman Pinze per ossa	381	Mead Martelli	429
Lampadine di ricambio per laringoscopi	279	Lucae Martelli	428	Mead Pinze- sgorbie	389
Landau Specoli vaginali	358	Lucae Pinze per orecchio	112	Meatotomi	465
Lane Cacciaviti	433	Luer-Koerte Cucchiali per calcoli biliari	469	Meeker Pinze per preparazione	139
Lane Pinze chirurgiche	108	Luer Pinze- sgorbie	390	Meniscotomi	372
Lane Pinze per fissare le compresse	145	M		Mercedes (Retractor) Divaricatori costali	333
Lane Pinze stomacali	447	M.G.H. (Mass.-General-Hospital) Portaghi	223	Method Distributori per ovatta	490
Lane Tenaglie per ossa	386	Magill Pinze per cannule	274	Metzenbaum-Fino Forbici, CT-ORO	82,83,85
Lange Forbici per bendaggi	61	Maisonneuve Uretrotomi	473	Metzenbaum-Fino Forbici, Supercut	67,68
Lange-Hohmann Elevatori per ossa	379	Mandrini per sonde uretrali	474	Metzenbaum Forbici per dissezione	31,32,37,40,41
Lange Pinze per agraiffe	250	Mani di piombo	440	Metzenbaum Forbici, CT-ORO	78,79,84
Langenbeck Divaricatori	164	Manici per batteria	279	Metzenbaum-Lahey Forbici, CT-ORO	84
Langenbeck Elevatori	375	Manici per bisturi	7-10	Metzenbaum-Nelson Forbici per dissezione	33-36
Langenbeck Periostotomi	418,419	Markwalder Pinze taglienti per ossa	394	Metzenbaum-Nelson Forbici, Supercut	68
Langenbeck Portaghi, CT- ORO	240	Marquardt Pinze- sgorbie	391	Metzenbaum Portaghi	223
Langenbeck Seghe per amputazione e resezione	427	Martel Pinze emostatiche	117	Metzenbaum Portaghi, CT-ORO	239
Langenbeck Tenaglie per ossa	384	Martelli	428-432	Metzenbaum-S Forbici, CT-ORO	80
Laringoscopi	275-279	Martelli percussori	266	Metzenbaum-Thorek Forbici, CT-ORO	80
Lawrence Pinze per preparazione	139	Martin Divaricatori	173	Meyerding Divaricatori	157
Lebsche Scalpelli per sterno	291	Martin Isterometri uterini	350	Michel Agraife	251
Lees Pinze cardiovascolari, Atraumatic	311,312	Martin Pelvimetri	369	Michel Pinze per agraiffe	250
Legueu Divaricatori addominali	208	Martin Spatole addominali	216	Michel Set per sutura	251
Legueu Divaricatori vescicali	467,468	Martin Tenaglie per ossa	382	Micro-Adson Pinze chirurgiche	106
Leksell-Stille Pinze- sgorbie	392	Martini Curette taglienti	406	Micro-Adson Pinze per dissezione, CT-ORO	98
Leland-Jones Pinze cardiovascolari, Atraumatic	306	Masson Portaghi	224	Micro- Pinze	90,92
Lempert Curette taglienti	403	Masson Portaghi, CT-ORO	235	Micro- Portaghi	218-221
Lempert Pinze- sgorbie	389	Mathieu Divaricatori	190	Microvascular Portaghi, CT-ORO	238
Lerche Pinze chirurgiche	103	Mathieu-Kocher Portaghi, CT-ORO	239	Middeldorp Divaricatori	167,171
Leriche Pinze emostatiche	119	Mathieu Pinze per corpi estranei	465	Mikulicz Divaricatori	184
Leriche Spatole addominali e intestinali	187	Mathieu Portaghi	226,227	Mikulicz Pinze per peritoneo	143
Lesine	423	Mathieu Portaghi, CT-ORO	239	Miller-Baby Set per laringoscopia per bambini e neonati	275
Lewin Tenaglie per ossa	383	Mathieu Specoli e Valve vaginali	356	Miller Laringoscopi	275
Lexer-Baby Forbici per dissezione	39	Mathieu Specoli rettali	456	Miller Set per laringoscopia	275
Lexer-Fino Forbici per preparazione	40	Matson Periostotomi	422	Miller Spatole per laringoscopia	275
Lexer Forbici per dissezione	39	Mayfield Pinze- sgorbie	391	Milligan Divaricatori	195
Lexer Forbici, CT-ORO	81	Mayo-Adams Divaricatori addominali	203	Millin Divaricatori del collo vescicali	467
Lexer Forbici, Supercut	68	Mayo-Blake Pinze per calcoli biliari	463	Millin Divaricatori vescicali	468
Lexer Scalpelli ed Osteotomi	412,413	Mayo Cucchiali per calcoli biliari	470	Millin Pinze per prendere capsule, Atraumatic	464
Lichtenberg Portaghi	227	Mayo Forbici per dissezione	24	Millin Pinze per prostata	464
Lichtenberg Portaghi, CT-ORO	240	Mayo Forbici, CT-ORO	76	Mini-Adson Pinze chirurgiche	106
				Mini-Friedmann Pinze- sgorbie	388



Mini-Gemini Pinze per preparazioni e legature	130	Overholt-Mixer Pinze per preparazione e legature	128	Pinze per dissezione, CT-ORO	97-100
Mini-Hohmann Elevatori per ossa	377			Pinze per emorroidi	455
Mini-Lambotte Scalpelli ed Osteotomi	413	P		Pinze per fissare le compresse (Fissateli)	144-146
Mini-Langenbeck Divaricatori	157	Padelle	488	Pinze per isterectomia	140,142
Mini-Lexer Scalpelli ed Osteotomi	412	Parametrium Forbici, CT-ORO	86	Pinze per isterectomia, Atraumatic	141
Mini-Roux Divaricatori	189	Parker Divaricatori	189	Pinze per legature	127-132,138,139
Mixer-Baby Pinze per preparazioni e legature	132	Parker-Langenbeck Divaricatori	190	Pinze per medicatura	112,148-151
Mixer-O'Shaugnessy Pinze emostatiche	133	Parker-Mott Divaricatori	189	Pinze per medicatura e polipi	148-151
Mixer Pinze emostatiche	127,132	Partsch Martelli	429	Pinze per medicatura e tamponi	148-151
Mixer Pinze per bronchi e vie biliari	133,134	Partsch Scalpelli e Osteotomi	407,408	Pinze per nefrostomia	463
Mixer Pinze per calcoli biliari	463	Pinze e Schiacciatori per intestino e stomaco	446	Pinze per neonati e bambini, Atraumatic	323-326
Mock Canule vascolari per irrigazione	338	Payr Pinze e Schiacciatori per intestino e stomaco	446	Pinze per orecchio	112
Mod.USA Forbici ombelicali	49	Payr Sonde conduttrici	249	Pinze per ossa e costole (Costotomi)	381
Mod.CEATEC Portacotone	264	Péan-Kocher Pinze emostatiche	125,126	Pinze per peduncoli renali	135,136
Mod.Martin Sonde conduttrici	247	Péan-Nippon Pinze emostatiche	123	Pinze per peduncoli renali, Atraumatic	135
Mod.Michel Pinze per agraiffe	250	Péan Pinze emostatiche	122,125,126	Pinze per peritoneo	143
Mod.Muenchen Curette d'aspirazione per biopsia	347	Pederson Specchi vaginali	352	Pinze per polipi	148-151
Mod.Tübingen Divaricatori	173	Peers-Bertram Pinze per fissare le compresse	145	Pinze per polipi uterini	344
Mod.USA Curette taglienti	405	Pelvimetri	369	Pinze per preparazioni e legature	127-132,138,139
Mod.Wien Strumenti per nodi	249	Penner Strumenti per unghie	441	Pinze per prostata	464
Moeltgen Goniometri per la membra	269	Pennington Pinze per afferrare tessuti	257	Pinze per prostata, Atraumatic	464
Mollison Divaricatori	194	Percy Retrattori per amputazione	381	Pinze per rifiuti	498
Moore Cucchiali per calcoli biliari	470	Perforatori	424-426	Pinze per schegge	110,111
Moore Perforatori a mano	425	Periostotomi	418-422	Pinze per sterilizzazione	476
Morris-De Bakey Pinze cardiovascolari, Atraumatic	312	Perthes Strumenti da perforazione	423	Pinze per tamponi	148-151
Morse-Favaloro Divaricatori costali	330	Pestalozza Curette per aborto	368	Pinze per tamponi e medicatura uterina	148
Mosquito-Dandy Pinze emostatiche	120	Pestoni	417	Pinze per tumori	91
Moynihhan Pinze emostatiche	142	Petz, Dr.v. , Apparecchi per la sutura gastro-intestinale	458	Pinze per vie biliari	133,134,137
Museux Pinze per afferrare il tessuto ed organi	259	Phaneuf Pinze per isterectomia	140	Pinze sgorbie	388-393
		Philips Cacciaviti	433	Pinze stomacali	446,447
N		Pierce Tre quarti	283	Pinze tagliafilii	398,400
Nabatoff Astucci per varici	263	Pinard Stetoscopi	267	Pinze tagliafilii, CT-ORO	400
Naegele Forcipi	366	Pinze anatomiche per dissezione	93-96	Pinze taglienti per biopsia	345,346
Neff Meniscomi	372	Pinze Bulldog	114,115	Pinze taglienti per biopsia rettale	454,455
Negus Pinze emostatiche	139	Pinze Bulldog	114,115	Pinze taglienti per ossa	394-396
Neivert Portaghi	222	Pinze Bulldog, Atraumatic	115,295,296,302,303	Pinze- Titanio Bulldog, Atraumatic	293
Nélaton Sonde	262	Pinze Bulldog, Atraumatic, in titanio	293	Pinze torciffili CT-ORO	397
Nelson Pinze chirurgiche	108	Pinze cardiovascolari, Atraumatic	297-301,304-326	Pinze vaginali	140,142
Nelson Tre quarti	282	Pinze chirurgiche	101-108	Pinze, Atraumatic	292
Newman Protoscopi	457	Pinze- copercchio	484	Pinze, Micro-	90,92
Nissen Pinze per bronchi e vie biliari	137	Pinze da orologio	107	Pinze, modelli fini	109
Northbent Forbici per legature	60	Pinze depilatorie	110,111	Pistola lavatrice a getto d'acqua	494
Noto Pinze per polipi uterini	344	Pinze e Schiacciatori per intestino e stomaco	446	Plester Divaricatori	194
Novak Curette per biopsia	347	Pinze emostatiche	116-129,131-134,138,139,140,142	Polloson Divaricatori	179
Nuboer Tubi d'aspirazione	286	Pinze emostatiche Atraumatic	297	Poole Tubi d'aspirazione	285
Nussbaum Pinze stomacali	447	Pinze gastro- intestinali, Atraumatic	449-452	Poppen Tubi d'aspirazione	283
		Pinze intestinali	444-446,448	Portacotone	264
O		Pinze intestinali, Atraumatic	449-452	Portaghi	222-227
Ochsner Pinze cardiovascolari, Atraumatic	297	Pinze ombelicali	366	Portaghi, CT-ORO	231-240
Ochsner Pinze per agraiffe	250	Pinze per abbassare il collo dell'utero	341-343	Portaghi, Micro	218-221
Ochsner Tre quarti	282	Pinze per afferrare e rompere le lamette	6	Potts (DeBakey) Pinze cardiovascolari, Atraumatic	304
O'Connor Divaricatori	155	Pinze per afferrare l'utero	344	Potts Pinze cardiovascolari, Atraumatic	304,305
Oehler Pinze per dissezione, CT-ORO	99	Pinze per afferrare tessuti ed organi	254,255,257,259	Potts-Smith Forbici cardiovascolari	44,45
Olivercrona Forbici per neurochirurgia	46	Pinze per afferrare tessuti ed organi, Atraumatic	256,258	Potts-Smith Forbici, Supercut	69
Olivercrona Pinze- sgorbie	390	Pinze per afferrare tessuti ed organi, CT-ORO	256	Potts-Smith Pinze anatomiche per dissezione	96
Ollier Divaricatori	162	Pinze per agraiffe	250	Potts-Smith Pinze chirurgiche	105
Olsen-Hegar Portaghi	226	Pinze per anastomosi	448	Potts-Smith Pinze per dissezione, CT-ORO	99
Olsen-Hegar Portaghi, CT-ORO	238	Pinze per anastomosi del retto, Atraumatic	452,453	Pozzi Pinze per afferrare tessuti ed organi	259
Ombredanne Martelli	432	Pinze per bronchi	294	Pratt Pinze per emorroidi	455,456
Osteotomi	407-416	Pinze per bronchi e vie biliari	133,134,137	Presbyterian Fissateli	146
O'Sullivan-O'Connor Divaricatori addominali	211	Pinze per calcoli biliari	463	Price-Thomas Pinze per bronchi	294
O'Sullivan-O'Connor Specchi vaginali	359	Pinze per calcoli renali	462	Protoscopi	457
Otis Uretrotomi	473	Pinze per canule	274	Providence-Hospital Pinze emostatiche	119
Overholt-Geissendoerfer Pinze emostatiche	129	Pinze per corpi estranei	148	Putti Raspe	417
		Pinze per cuoio capelluto	367		



R		
Rabiner Martelli percussori	266	
Raccordi per pistola lavatrice	495	
Radolf Strumenti per unghie	441	
Ragnell (Killner) Forbici, CT-ORO	88	
Ragnell-Davis Divaricatori	158	
Ralk Perforatori a mano	426	
Rampley Pinze per tamponi	151	
Randall Curette per biopsia	347	
Randall Pinze per calcoli renali	462	
Raspe	417	
Recamier Curette uterine	349	
Recipienti	487	
Recipienti cilindrici	484	
Recipienti per ovatta e tamponi	487	
Redon Aghi per introduzione	287	
Reill Tenaglie per ossa	383	
Resano Pinze per anastomosi del retto, Atraumatic	453	
Retrattori	381	
Rettoscopi	459	
Reverdin Aghi	241,242	
Reverdin Spatole addominali	216	
Reynolds Forbici fine per chirurgia	43	
Reynolds Forbici, Supercut	68	
Ricard Divaricatori addominali	205	
Richardson Divaricatori	168	
Richardson-Eastmann Divaricatori	168	
Richter-Heath Pinze per agraiffe	250	
Richter Pinze per incisione	23	
Robb Spatole per la intima	335	
Roberts Pinze emostatiche	128	
Rochard Divaricatori addominali	214	
Rochester-Carmalt Pinze emostatiche	121	
Roeder Pinze per fissare le compresse	144	
Rogers Pinze per isterectomia, Atraumatic	141	
Rogge Pinze per sterilizzazione	476	
Ross Divaricatori	178	
Roux Divaricatori	188	
Rumel-Belmont Tornichetti	338	
Rumel Pinze per preparazioni	131	
Ruskin-Liston Pinze taglienti per ossa	395	
Ruskin Pinze- sgorbie	391	
Russ.Modell Pinze per dissezione	107	
Ryder Portaghi, CT-ORO	235	
Ryder-Vascular Portaghi, CT-ORO	236	
S		
Sachse Meatotomi	465	
Saenger Pinze per cuoio capelluto	367	
Salenius Meniscomi	372	
Salpingografi	363	
Santulli Pinze Bulldog, Atraumatic	295	
Sanvenero Forbici fine per chirurgia	42	
Sarot Pinze emostatiche	128	
Sarot Portaghi, CT-ORO	234	
Satinsky/DeBaKey Pinze cardiovascolari, Atraumatic	310	
Satinsky Forbici per la chirurgia cardiovascolare	44	
Satterlee Seghe per amputazione e resezione	427	
Sauerbruch Divaricatori	175,178	
Sauerbruch Forbici per sterno	291	
Sauerbruch Pinze per rifiuti	498	
Sauerbruch Pinze- sgorbie	393	
Sauerbruch Scatole per sterilizzare aghi	481	
Scalp-Contour Divaricatori	192	
Scalpelli	407-416	
Scalpelli per sterno	291	
Scatole per sterilizzare aghi	481,482	
Scatole per sterilizzazione e conservazione	485	
Scatole per strumenti	486	
Schaedel Pinze per fissare le compresse	144	
Schede Curette taglienti	402	
Scheibe Pinze per afferrare il tessuto ed organi, Atraumatic	258	
Scherbak Set di Specoli vaginali	357	
Schimmelbusch Cestelli rotondi per sterilizzazione	479	
Schink Dermatomi	13	
Schmid Aghi vascolari per irrigazione	338	
Schmieden Aghi per legatura	243	
Schmieden-Dick Aghi per legatura	243	
Schmieden-Payr Sonde conduttrici	248	
Schmieden Sonde conduttrici	248	
Schmieden-Taylor Forbici per dura-madre	46	
Schnidt Pinze emostatiche	121	
Schoemaker-Loth Forbici per legatura	60	
Schröder Curette uterine	348	
Schroeder Pinze per abbassare il collo dell'utero	342	
Schroeder Pinze per afferrare tessuto ed organi	259	
Schubert Pinze taglienti per biopsia	345	
Schuhmacher Forbici ombelicali	49	
Schultze Salpingografi	363	
Schumacher Pinze taglienti per biopsia	346	
Schwedisch- Pattern Curette taglienti	403	
Scodelle per liquidi	478	
Scodelle per soluzioni	478	
Scodelle rotonde	480	
Scollatendini	438,439	
Scoville Divaricatori per laminectomia	215	
Scudder Pinze gastro- intestinali, Atraumatic	451	
Secchi	498	
Sedillot Periototomi	419	
Seghe per amputazione e resezione	427	
Seghe per anelli	441	
Segond Bisturi per fibromi	340	
Segond-Landau Pinze emostatiche	142	
Sellheim Cucchiari ostetrici	368	
Sellers Approssimatori costali	334	
Semb Periototomi	422	
Semb Pinze per bronchi	294	
Semb Pinze- sgorbie	392	
Semb Pinze taglienti per ossa	396	
Semb Tenaglie per ossa	385	
Semken Pinze anatomiche per dissezione	95	
Semken Pinze per dissezione	104	
Semken Pinze per dissezione, CT-ORO	97	
Semm Specoli vaginali	352	
Senn-Green Divaricatori	158	
Senn-Mueller Divaricatori	158	
Serrapene	465	
Set per laringoscopia	275-278	
Set per sutura	251	
Seyffert Specoli vaginali	352	
Sfigmomanometri	271	
Sfinteroscopi	457	
Shaaf Pinze depilatorie	110	
Shea Forbici fini per chirurgia	43	
Siebold Forbici per ginecologia	30	
Siebold Forbici, Supercut	67	
Simon Curette taglienti	404	
Simon Curette uterine	348	
Simon Divaricatori	173	
Simon Uncini per fistole	340	
Simpson-Braun Forcipi	366	
Simpson Forcipi	366	
Simpson-Luikart Forcipi	366	
Sims Curette uterine	349	
Sims Forbici per ginecologia	29	
Sims Forbici, CT-ORO	86	
Sims Forbici, Supercut	67	
Sims Isterometri uterini	350	
Sims-Maier Pinze per medicature	149	
Sims Specoli rettali	456	
Sims Specoli vaginali	353	
Single-Tuttle Pinze per dissezione	108	
Skene Pinze per abbassare il collo dell'utero	342	
Smillie Divaricatori spinali	380	
Smillie Meniscomi	372	
Smith-Petersen Scalpelli e Osteotomi	414,415	
Snitman Divaricatori	192	
Somer Pinze per afferrare l'utero	344	
Sonde	262	
Sonde conduttrici	247-249	
Sonde metalliche	472	
Sonde per calcoli biliari	471	
Sonde per endarterectomia	264	
Spatole addominali	186,187,216	
Spatole intestinali	186,187	
Spatole per la intima	335	
Spatole per laringoscopia	275-278	
Spatole per polmoni	334	
Spazzole per pulizia	497	
Spazzole per unghie	477	
Specoli rettali	456	
Specoli vaginali	351-359	
Spencer Forbici per legature	60	
Spencer-Wells Pinze emostatiche	116	
Spezial Fissatelli	146	
Spille di sicurezza	476	
Spratt Curette taglienti	402	
St.Marks Divaricatori	185	
Stacke Sonde	262	
Standard Forbici per chirurgia	16-21,75	
Standard Forbici, CT-ORO	75	
Standard Forbici, Supercut	66	
Standard Manici per bisturi	7,9	
Standard Pinze anatomiche per dissezione	93,94	
Standard Pinze chirurgiche	101	
Standard Pinze emostatiche	116	
Standard Pinze- sgorbie	388	
Standard Tre quarti	282	
Staude-Moore Pinze per abbassare il collo dell'utero	341	
Steinmann Strumenti per afferrare tendini	373	
Stellbrink Pinze- sgorbie	388	
Stetoscopi	267,268	
Stevens Forbici fine per chirurgia	52	
Stevens Forbici, Supercut	69	
Pinze per schegge	111	
Stille-Barraya Pinze chirurgiche	103	
Stille Cesioie per apparecchi gessati	63	
Stille Forbici per ossa e costole	290	
Stille-Liston Pinze taglienti per ossa	395	
Stille-Luer Pinze- sgorbie	393	
Stille Perforatori a mano	424	
Stille Pinze anatomiche per dissezione	94	
Stille Pinze chirurgiche	103	
Stille Pinze per peduncoli renali	136	
Stille Pinze- sgorbie	392	
Stille-Ruskin Pinze- sgorbie	392	



Stille Scalpelli e Osteotomi409,410	Tubi d'aspirazione283-286	Weitlaner-Baby Divaricatori.....195
Stockmann Serrapene.....465	Tuffier Divaricatore.....172	Weitlaner Divaricatori.....192,193
Stone Pinze chirurgiche103	Tuffier Divaricatori costali.....332	Weitlaner-Loktite Divaricatori.....193
Stone Pinze per l'intestino.....448	Tuffier Pinze per afferrare tessuti.....257	Weitlaner-Wullstein Divaricatori.....194
Stone-Watt Pinze per l'intestino.....448	Turnbull Tronchesine per unghie.....493	Wertheim-Cullen Pinze vaginali.....140
Strandell-Stille Divaricatori.....160		Wertheim Forbici per ginecologia.....28
Stratte Portaghi.....226		Wertheim Pinze emostatiche.....140,142
Stratte Portaghi, CT-ORO.....237		Westcott Forbici micro.....53
Strauss Rettoscopi.....459	U	Wickström Pinze emostatiche.....133
Strauss Serrapene.....465	Ulrich Pinze per tamponi.....148	Williams Pinze per afferrare tessuti ed organi.....255
Strully Forbici per neurochirurgia.....46	Ulrich Tenaglie per ossa.....386	Williger Curette taglienti.....403,406
Strumenti per afferrare tendini.....373,374	Uncini per fistole.....340	Williger Elevatori.....376
Strumenti per circoncisione.....474	Universal Forbici per bendaggi.....61	Williger Martelli.....428
Strumenti per esaminare.....269	Universal Forbici, CT-ORO.....88	Williger Periotostomi.....421
Strumenti per guaina tendinea.....438,439	Universal Trequarti.....282	Winter Pinze per cuoio capelluto.....367
Strumenti per misurare.....269,270	Uretrotomi473	Wullstein Tubi d'aspirazione.....284
Strumenti per misurare la sensibilità.....267		
Strumenti per nodi.....249	V	
Strumenti per perforazione.....423	Valleix Isterometri uterini.....350	Y
Strumenti per sutura.....241,242	Valve intercambiabili.....206,207	Yankauer Tubi d'aspirazione.....284
Strumenti per unghie.....440,441	Valve vaginali.....353-359	Yasargil Micro- Pinze.....90
Strumenti tendifili.....435	Van Buren Candelette dilatatrici.....472	Yasargil Tubi d'aspirazione.....284
Subramanian-Miniature Pinze per aorta.....323	Van Buren Tenaglie per ossa.....381	Yeoman Pinze taglienti per biosia rettale.....454
Subramanian Pinze per aorta.....323	Van Doren Pinze taglienti per biopsia.....345	Young Divaricatori prostatici.....466
Supercut Forbici.....65-72	Vassoi porta strumenti.....483	Young Strumenti per sutura.....242
	Veidenheimer Pinze per anastomosi del retto, Atraumatic.....453	
T	Venenhaken Brom Divaricatori.....160	Z
Taylor Divaricatori spinali.....380	Verbrugge Tenaglie per ossa.....387	Zenker Divaricatori.....166
Taylor Mod.USA Martelli percussori.....266	Vernier Calibratori.....270	Zenker Pinze per preparazione e legature.....132
Taylor Pinze anatomiche per dissezione.....95	Vickers Divaricatori.....201	Zweifel Portaghi, CT-ORO.....240
Taylor Pinze per dissezione.....104	Vickers Low-Profile Divaricatori.....201	
Teale Pinze per abbassare il collo dell'utero.....342	Vickers Martelli.....432	
Tenaglie per afferrare.....398	Virchow Coltelli per cartilagini.....3	
Tenaglie per ossa.....381-388	Virchow Coltelli per il cervello.....4	
Tenaglie piatte.....398	Volkman Curette taglienti.....401,402,405,406	
Tenaglie piatte, CT-ORO.....399	Volkman Divaricatori.....160,161	
Tenaglie tagliafili, CT-ORO.....400	Vollmar Aghi vascolari per irrigazione.....338	
Tenaglie tagliafili.....398,400	Vollmar Sonde per endarterectomia.....264	
Thoms-Allis Pinze per afferrare tessuti ed organi.....255		
Thoms-Gaylor Pinze taglienti per biopsia.....345	W	
Thomson-Walker Divaricatori vescicali.....467	Wachenfeldt Pinze per agraffe.....250	
Thorek Forbici per dissezione.....44	Wagner Forbici fine per chirurgia.....50	
Titan- Elevatori.....376	Wagner Forbici, Supercut.....71	
Titan- Pinze Bulldog, Atraumatic.....293	Walb Coltelli per autopsia.....4	
Toennis-Adson Forbici per dissezione.....46	Waldmann Forbici per episiotomia.....48	
Toennis-Adson Forbici, CT-ORO.....84	Waldmann Forbici, Supercut.....70	
Toennis Forbici per dissezione.....46	Wallich Curette per aborto.....368	
Toennis Pinze emostatiche.....131	Walter-Carmalt Pinze per schegge.....110	
Toennis Portaghi.....227	Walton Pinze per medicatura.....148	
Toennis Portaghi, CT-ORO.....240	Walton Seghe per anelli.....441	
Tohoku Pinze per fissare le compresse.....145	Wangensteen Pinze anatomiche per dissezione.....96	
Tornado Forbici per bendaggi.....62	Wangensteen Pinze per dissezione, CT-ORO.....100	
Tornichetti.....338	Wangensteen Portaghi.....225	
Townley Calibri.....269	Wangenstein Portaghi, CT-ORO.....236	
Trapani a mano.....424-426	Wartenberg Strumenti per misurare la sensibilità.....267	
Trélat Specoli vaginali.....352	Wassmund Divaricatori.....162	
Trequarti.....282,283	Watson-Cheyne Elevatori.....377	
Troeltsch Pinze per medicature.....112	Waugh Pinze anatomiche per dissezione.....96	
Troeltsch-Wilde Pinze per orecchio.....112	Waugh Pinze chirurgiche.....105	
Tronchesine per unghie.....492	Weber Pinze cardiovascolari, Atraumatic.....310	
Tronchesine per unghie e pelle.....493	Weber Strumenti per misurare la sensibilità.....267	
Trotter Pinze- sgorbie.....390	Webster Portaghi.....222	
Troutman-Chris Pinze per afferrare le lamette del rasoio.....6	Webster Portaghi, CT-ORO.....233	
Tubbs Dilatatori vascolari.....336	Weissbarth Specoli e Valve vaginali.....357	



A		B		Bonn Tijeras finas para cirugía51
Acumuladores recargables, laringoscopios.....279		Babcock Pinzas para tejidos y órganos256		Bonney Pinzas de disección con dientes108
Adlerkreutz Pinzas de disección con dientes103		Babcock CT-ORO Pinzas para tejidos y órganos256		Bonney Pinzas de disección CT-ORO.....97
Adson Elevadores375		Baby-Allis Pinzas para tejidos y órganos.....254		Boynon Porta-agujas.....227
Adson Instrumental para perforar.....423		Babcock-Atrauma Pinzas para tejidos y órganos256		Boys-Allis Pinzas para tejidos y órganos.....254
Adson Pinzas de disección.....95		Baby-Duplex Estetoscopios264		Bozemann Pinzas para vendajes150
Adson Pinzas de disección con dientes104		Baby-Collin Separadores abdominales.....203		Bozemann Porta- agujas CT-ORO237
Adson Pinzas de disección CT-ORO98		Baby-Doyen Pinzas- clamps intestinales444		Bozemann-Douglas Pinzas para vendajes150
Adson Pinzas hemostáticas121		Baby-Metzenbaum Tijeras Supercut.....67		Brand Instrumentos para coger tendones373
Adson Pinzas hemostáticas, p/preparac. y ligaduras.....127		Baby-Mikulicz Pinzas- clamps para peritoneo143		Braun Depresores uterinos.....350
Adson Pinzas para proteger la dura madre.....423		Baby-Mixer Pinzas para preparaciones117		Braun Espéculos y valvas vaginales355
Adson Porta- agujas223		Baby-Overholt Pinzas hemostáticas119		Braun Pinzas para coger el cuello del útero.....341,343
Adson Separadores193,196,198		Baby-Roux Separadores189		Braun-Stadler Tijeras para episiotomía48
Adson Tubos de aspiración283		Backhaus Pinzas de campo144		Braun-Stadler Tijeras Supercut.....70
Adson-Brown Pinzas de disección con dientes.....106		Bailey Aproximadores para costillas334		Breisky Espéculos y valvas vaginales358
Adson-Brown Pinzas de disección CT-ORO98		Bailey-Baby Aproximadores para costillas334		Breisky Pelvímetros369
Agrafes (graspas).....251		Bailey-Gibbon Aproximadores para costillas334		Brom Separadores. (gancho para venas)160
Agujas de guía.....287		Bainbridge Atraumatic Pinzas-clamps cardiovasculares306		Brophy Pinzas de disección con dientes105
Agujas de repuesto para sutura242		Bakes Dilatadores para conductores biliares.....471		Brophy(Sullivan) Tijeras finas para cirugía43
Agujas de Reverdin241,242		Balfour Separadores abdominales209-211		Brown Porta- agujas222
Agujas para ligaduras.....243-246		Balfour US-Type Separadores abdominales.....211		Brunner Atraumatic Pinzas- clamps intestinales452
Agujas pasa- hilos435		Balfour-Baby Separadores abdominales209		Brunner Separadores.....175-177
Alan-Parks Espéculos rectales.....457		Bandejas de esterilización.....489		Brunner Sondas conductoras.....247
Alderdyce Elevadores377		Bandejas para instrumentos.....483		Brunner Costómos (cizallas para esternón).....291
Alexander Cinceles para huesos.....408		Bandejas rectangulares.....483,489		Brunner Ferrozell Sondas conductoras.....248
Alexander Legras-Periostotomos422		Bandejas redondas478,480,483,487,488		Bruns Cucharillas cortantes.....402,404
Alexander Pinzas saca- bocados para biopsia346		Bandejas universales483		Bruns Tijeras para vendajes61
Alicates para cortar alambre.....400		Bandejitas para medicinas487		Bruns Tijeras para vendajes, CT-ORO64
Alicates para cortar alambre.....398,400		Barraquer Micro- porta- agujas218,219		Buck Martillos de percusión.....266
Alicates planos398,399		Barraquer Pinzas depilatorias.....111		Buck Tijeras para ligaduras60
Alicates planos CT-ORO399		Barraquer Porta- agujas CT-ORO232		Bujías Dilatadoras472
Alm Separadores191		Barraquer-Troutman Micro- porta-agujas.....218		Bulldog Clamps114,115,293,295,296
Aly Instrumentos para examinar la sensibilidad267		Barret Pinzas para coger el cuello del útero.....341		Bulldog Clamps Atraumatic.....115,293,295,296,302,303
Alta Calidad Tijeras.....64		Beacham Amniótomos para la vesícula amniótica341		Bulldog Clamps Atraumatic titanio.....293
Allis Pinzas para tejidos y órganos.....254,255		Beck Atraumatic Pinzas- clamps cardiovasculares318,322		Bunnell Enucleadores para el tendón438
Allis-Adair Pinzas para tejidos y órganos254		Beck Atraumatic Pinzas-clamps para anastomosis322		Bunnell Instrumentos para el túnel del tendón.....438,439
Allis-Atrauma Pinzas para tejidos y órganos258		Beckmann Separadores198		Bunnell Perforadores de mano.....426
Allis-Baby Pinzas intestinales254		Beckmann-Adson Separadores199		Bunt Porta-instrumentos para esterilización476
Allison Espátulas pulmonares334		Beckmann-Eaton Separadores.....199		Burford Separadores costales de aluminio329
Amniótomos para la vesícula amniótica341		Beebee Tijeras para coronas53		Busch Tijeras umbilicales49
Anderson-Adson Separadores.....192		Beer Pinzas depilatorias.....111		Byrd Tubos de aspiración286
Anestophon Estetoscopios268		Bengolea Pinzas hemostáticas124		
Anuscopios457		Bennett Elevadores para huesos380		
Aparatos para suturar estómago e intestinos.....458		Bergmann Martillos431		
Aproximadores para costillas334		Bergmann Tijeras para vendajes63		
Arruga Micro- porta- agujas218,221		Berliner Martillos de percusión266		
Arruga Porta- agujas CT-ORO232		Bernhard Pinzas de campo145		
Asch Cucharillas para secreciones.....465		Bertilion Cefaloméetro269		
Atraumatic Bulldog pinzas-clamps...115,293,295,296,302,303		Beyer Pinzas- gubias.....391		
Atraumatic Bulldog Titanio pinzas-clamps.....293		Bircher Bisturías para meniscos.....372		
Atraumatic Pinzas de disección.....292		Bircher-Ganske Pinzas para meniscos y cartílago382		
Atraumatic Pinzas hemostáticas y cardiovasculares297,316		Birkett pinzas hemostáticas, p/preparac. y ligaduras128		
Atraumatic Pinzas para histerectomía.....141		Bisturías2-5,7-13		
Atraumatic Pinzas para anastomosis del recto452-453		Bisturías para conos de atracción340		
Atraumatic Pinzas para pedúnculos renales135		Bisturías para disección anatómica.....2		
Atraumatic Pinzas para tejidos y órganos256,258		Bisturías para fibroma340		
Atraumatic Pinzas- clamps cardiovasculares 297-301,304-326		Bisturías para meniscos372		
Atraumatic Pinzas- clamps estomacales449-451		Blake Curetas uterinas.....350		
Atraumatic Pinzas- clamps intestinales.....449-452		Blake Pinzas para cálculos biliares.....463		
Atraumatic Pinzas- clamps p/recién		Blount Elevadores para huesos380		
nacidos y pediátríc.....323-326		Blount Separadores para menisco380		
Auvard Espéculos vaginales357		Blumenthal Pinzas- gubias390		
Ayre Bisturías para conos de atracción340		Böhler Extribos para extensión.....436		
		Böhler Pinzas cortantes para huesos.....395		
		Böhler Pinzas- gubias.....391		
		Bombillas de repuesto, laringoscopios.....279		



Cepillos de limpieza.....	497	Coryllos Separadores.....	174	Davidson Separadores.....	174
Cepillos para limpiar pipetas	495,497	Costótomos	290,291	De Bakey Atraumatic Pinzas- clamps	
Cepillos para uñas.....	477	Cottle Martillos.....	429	cardiovasculares	305-309,312,315,319
Chadwick Tijeras finas para cirugía	42	Cottle Tijeras nasales	47	De Bakey Dilatadores vasculares.....	337
Chaput Pinzas para tejidos y órganos.....	257	Cottle Tijeras Supercut.....	70	De Bakey Pinzas de disección Atraumatic	292
Charrière Sierras para amputación y resección	427	Cottle-Kazanjan Pinzas cortantes para huesos.....	394	De Bakey CT-ORO Pinzas de disección	100
Cheatle Pinzas para esterilización.....	476	Coupland Tubos de aspiración.....	286	De Bakey Pinzas- clamps p/aneurisma de aorta.....	307,308
Cheron Pinzas para vendajes.....	150	Crafoord Pinzas hemostáticas	128	De Bakey Pinzas- clamps para aorta	308,309
Chevalier Separadores costales.....	332	Crafoord Tijeras.....	44	De Bakey Pinzas- clamps para arteria renal.....	306
Childe Pinzas para agrafes.....	250	Crawford Separadores	178	De Bakey Pinzas- clamps para ligaduras	309
Cinceles de esponjosa	412	Crile Pinzas hemostáticas.....	120	De Bakey Pinzas- clamps para usos varios	315
Cinceles de esternón.....	291	Crile Porta- agujas	226	De Bakey Pinzas- clamps para vasos periféricos.....	305,306
Cinceles para huesos.....	407-416	Crile-Murray Porta- agujas.....	223	De Bakey CT-ORO Porta- agujas.....	235
Cintas métricas.....	270	Crile-Rankin Pinzas hemostáticas	120	De Bakey Separadores.....	202
Cizallas para huesos	290	Crile-Wood Porta- agujas	223	De Bakey Separadores costales.....	331
Cizallas para vendajes enyesados.....	63	Crile-Wood Porta- agujas CT-ORO	234	De Bakey-Bahnsen Pinzas-clamps	
Cizallas para vendajes enyesados CT-ORO	64	Cubetas para placenta	488	p/aneurisma de aortay de la arteria iliaca	313
Clamps Bulldog.....	114, 115,293,295,296	Cubetas para soluciones.....	478	De Bakey Carotis Atraumatic Clamps Bulldog.....	295
Clamps Bulldog Atraumatic.....	115,293,295,296,302,303	Cubetas para sondas	486	De Bakey-Dietrich Atraumatic Clamps Bulldog mini	115
Clamps Bulldog Titanio Atraumatic.....	293	Cubetas redondas	480	De Bakey-Glover Pinzas-clamps cardiovasculares	317
Clamps para anastomosis.....	448	Cubetas triangulares para urología	488	De Bakey-Mosquito Atraumatic pinzas hemostáticas	297
Clamps para intestino (anastomosis)	448	Cubos y Pinzas para desechos	498	De Bakey-Pean Atraumatic pinzas hemostáticas	316
Clamps porta-huesos	381	Cucharas graduadas.....	487	De Bakey-Potts-Smith CT-ORO Tijeras	87
Clamps umbilicales.....	366	Cucharillas cortantes.....	401-406	De Bakey-Rankin Atraumatic pinzas hemostáticas	297
Cleveland Pinzas cortantes para huesos	394	Cucharillas para aborto	368	De Bakey-Satinsky Atraumatic Clamps Bulldog	295
Cleveland Pinzas- gubias.....	389	Cucharillas para coger cálculos biliares	469,47	De Martel Porta- clamps	448
Cloward Separadores.....	197	Cucharillas para secreciones	465	De Martel-Wolfson Clamps para anastomosis	448
Coller-Crile Pinzas hemostáticas	120	Cucharillas uterinas	348	De Martel-Wolfson Pinzas para cerrar clamps	448
Collier Porta- agujas.....	222	Cuchillos.....	3-5	Dean Tijeras CT-ORO	88
Collin Clamps umbilicales.....	366	Cuchillo de repuesto para uretrotomo	473	Dean Tijeras nasales.....	47
Collin Costótomos (tijeras para huesos).....	290	Cuchillos para autopsia	3	Deaver Separadores.....	181-183
Collin Dinamómetro	269	Cuchillos para cartilagos	3	Deaver Tijeras para cirugía.....	23
Collin Espéculos vaginales.....	351	Cuchillos para cerebro.....	4	Déjerine Martillos de percusión	266
Collin Histerómetros	350	Cuchillos para fibroma.....	340	Demel Agujas pasa- hilos	435
Collin Mangos de bisturíes	8	Cuchillos para órganos.....	4	Denis-Browne Separadores abdominales.....	211
Collin Martillos	428	Cuchillos para resección	5	Depresores uterinos	350
Collin Pelvímetros.....	369	Cuchillos post mortem.....	3-4	Derf Porta- agujas	222
Collin Pinzas para ágrafes.....	250	Cuñas	488	Derf Porta- agujas CT-ORO	233
Collin Pinzas para el útero.....	344	Curetatas aspiradoras para biopsia.....	347	Dermatomos.....	13
Collin Pinzas para tejidos y órganos	257	Curetatas de aspiración.....	350	Derra Atraumatic Pinzas- clamps para anastomosis	318
Collin Pinzas para vendajes	149	Curetatas de biopsia y aspiración	350	Deschamps Agujas para ligaduras	244,246
Collin Separadores.....	189	Curetatas para aborto.....	368	Desjardins Cucharillas para cálculos biliares.....	469
Collin Separadores abdominales.....	203,204	Curetatas para biopsia	347	Desjardins Pinzas para cálculos biliares.....	463
Collin-Duval Pinzas para tejidos y órganos	254	Curetatas uterinas	348-350	Desjardins Pinzas-clamps para conducto biliar	137
Collin-Hartmann Separadores	188	Curetatas uterinas y de aspiración.....	350	Desjardins Sondas para cálculos biliares	471
Collin-Landau Espéculos vaginales.....	351	Cusco Espéculos vaginales	351	Desmarres Separadores	156
Collin-Loktite Separadores abdominales.....	204	Cushing Legras-Periostotomos.....	418	Desobilitadores de vasos.....	264
Combinación pinzas/tapa	484	Cushing Pinzas de disección	96	Destornilladores.....	433
Compás para medir vasos.....	301	Cushing Pinzas de disección con dientes.....	105	Dieffenbach Clamps Bulldog	114
Compresores para los dedos	440	Cushing Pinzas de disección CT-ORO	98	Dietrich Clamps Bulldog mini.....	115
Compresores uretrales.....	465	Cushing Separadores.....	158,159	Dietrich Atraumatic Pinzas- clamps cardiovasculares	297
Cooley Atraumatic Pinzas- clamps		Cushing Taladros para perforadores de mano	424	Dietrich Porta- agujas CT-ORO.....	231
cardiovasculares.....	301,320,321	Cushing-Taylor pinzas de disección CT-ORO	98	Dietrich Tijeras para la cirugía cardiovascular	45
Cooley Dilatadores para estenosis mitral (niños)	336	Cuzzi Cucharillas para aborto	368	Dilatadores	335-337,360-362,471
Cooley Dilatadores vasculares	337	Czerny Espéculos rectales	456	Dilatadores de aorta	336
Cooley Pinzas de disección Atraumatic.....	292	Czerny Pinzas para coger el cuello del útero	343	Dilatadores para conductores biliares	471
Cooley Pinzas-clamps para carótida	301	D		Dilatadores para el cuello vesical	467
Cooley Pinzas-clamps para coarctación.....	320	Dahlgren Pinzas saca- bocados craneanas		Dilatadores para estenosis mitral	336
Cooley Pinzas-clamps para íliaca.....	320	Dale Pinzas- clamps Atraumatic para vasos periféricos	299	Dilatadores para la íntima.....	335
Cooley Pinzas-clamps para ligaduras	321	Dandy Pinzas hemostáticas.....	120	Dilatadores uterinos	360-362
Cooley Pinzas-clamps para usos varios.....	321	Dandy Tijeras para neurocirugía.....	46	Dilatadores vasculares	337
Cooley Separadores	183	Dardik Pinzas- clamps Atraumatic para usos varios	298	Dinamómetro	269
Cooley Separadores costales de aluminio	327	Dartigues Pinzas para el útero	344	Dingmann Pinzas para menisco y cartilago.....	382
Cooley Tubos de aspiración	285	Daubenspeck Cucharillas cortantes.....	405	Discos fijadores para taladros filiformes.....	437
Cooley-Derra Pinzas- clamps para anastomosis	322			Disectores para tejidos blandos	376
Copas graduadas	480			Dispensadores de cepillos.....	477



Distribuidores para algodón.....	490	Farrell (Lathbury-Uebe) Porta- algodones	264	Gerster-Lowmann Pinzas porta- huesos.....	381
Distribuidores para gasa.....	490	Faure Pinzas saca- bocados para biopsia.....	345	Giertz-Stille Costótomos	291
Distribuidores para polvos.....	490	Faure Pinzas-clamps	142	Gil-Vernet Type Separadores p/venas e hilares.....	159
Douglas Pinzas depilatorias.....	111	Faure Pinzas- clamps para peritoneo e histerectomía	143	Gillies Ganchos	160
Douglas Trócares	283	Fehland Atraumatic Pinzas para anastomosis del recto	453	Gillies Pinzas de disección con dientes.....	104
Doyen Atraumatic Pinzas- clamps intestinales	449	Feilchenfeld Pinzas para espinas	110	Gillies Pinzas de disección CT-ORO.....	97
Doyen Espéculos vaginales.....	356,357,359	Feldheim Compresores para los dedos.....	440	Gillies Porta- agujas	226
Doyen Estiletes	262	Fergusson Cucharillas para cálculos biliares	470	Gillies Porta- agujas CT-ORO	238
Doyen Instrumentos para fibroma.....	340	Fergusson Pinzas para huesos.....	384	Gillies-Mini Porta- agujas CT-ORO.....	238
Doyen Martillos	428	Fergusson Tubos de aspiración.....	283	Glover Atraumatic Clamps Bulldog.....	295,303
Doyen Pinzas de campo.....	145	Ferris-Smith Pinzas de disección con dientes	108	Glover Atraumatic Pinzas- clamps cardiovasculares	317
Doyen Pinzas para pólipos uterinos	344	Ferrozell Sondas conductoras.....	248	Gluck Costótomos (cizallas para huesos)	290
Doyen Pinzas- clamps intestinales	444	Finocchietto CT-ORO Porta- agujas	236	Goelt Separadores.....	190
Doyen Separadores.....	172	Finocchietto Pinzas hemostáticas	134	Goldmann-Fox Tijeras finas para cirugía.....	50
Doyen Tijeras para ginecología	30	Finocchietto Pinzas-clamps p/bronquios y conducto biliar.....	134	Godmann-Fox Tijeras CT-ORO	87
Doyen Legras- Periostotomos	421	Finocchietto Porta- agujas	225	Gomel Micro- Pinzas para tumores	91
Doyen-Stille Separadores	169	Finocchietto Separadores costales	333	Gomel Micro- Tijeras.....	55
Duplay Pinzas para coger al cuello del útero	341	Finocchietto Separadores costales de aluminio.....	330	Goniómetros para dedos.....	269
Duplay Pinzas para cuerpos extraños.....	148	Finocchietto (modif.) , Separadores costales de aluminio.....	328	Goniómetros para miembros.....	269
Duplex Estetoscopios	268	Finocchietto Separadores costales de aluminio.....	333	Good Tijeras para amígdalas.....	47
Durante Pinzas de disección con dientes.....	107	Finocchietto-Baby Separadores costales	333	Gorney Tijeras para preparaciones	38
Duval Pinzas para tejidos y órganos.....	257	Finocchietto-Baby-Haight Separadores costales de aluminio	328	Gorney Tijeras Supercut.....	72,73
Duval CT-ORO Pinzas para tejidos y órganos	256	Finsen Mod.Martin Separadores	191	Gosset Separadores abdominales	208
E					
Echlin Pinzas- gubias	392	Finsen Separadores	191	Gourdet Curetas uterinas	348
Eiselsberg Tijeras para ligaduras.....	60	Fischer Instrumentos para el tendón	439	Graefe Separadores, (Ganchitos para nervios)	155
Elevadores	375-380	Fischer Separadores para tendones	439	Graefe Tijeras finas para cirugía.....	51
Elevadores micro.....	376	Foerster Pinzas para vendajes	151	Grave Espéculos vaginales.....	352
Elevadores para el peristio	376	Foerster Separadores abdominales	213	Gray Pinzas-clamps para conducto biliar.....	137
Elevadores para huesos.....	377-380	Fomon Tijeras nasales	47	Grazil Tijeras para cirugía.....	22
Elliot Forceps obstétricos	366	Fomon Tijeras para preparaciones.....	47	Grazil Tijeras finas para cirugía	52
Elsässer Pinzas para nefrostomía.....	463	Fomon Tijeras Supercut	70	Green-Armytage Pinzas para pericráneo	367
Endospéculos	359	Forceps obstétricos	366	Greene Curetas uterinas.....	348
Engl. Modell Pinzas de campo.....	144	Forceps para entrelazar tendones.....	374	Gregory Pinzas- clamps Atraumatic, profundales	299
Enucleadores.....	438	Ford Estetoscopios	268	Gregory-Soft Atraumatic Clamps Bulldog.....	296
Eppendorf Pinzas para biopsia	346	Foregger Juegos para laringoscopia	278	Gross-Maier Pinzas para vendajes	149
Errico Taladros para perforadores de mano	424	Frazier Tubos de aspiración	283	Gruenwald (Jansen) Pinzas para taponamientos nasales	112
Escariadores.....	423	Freemann Tijeras Supercut	72	Gruenwald Pinzas disección CT-ORO	99
Escupideras.....	487	Freemann-Gorney Tijeras Supercut	72	Gubias para huesos	407-416
Esfinteroscopios	457	Freemann-Kaye Tijeras Supercut	72	Guedel-Negus Juegos para laringoscopia	276
Esmarch Tijeras para vendajes	61	Friedmann Pinzas- gubias.....	388	Gunnar-Hey Pinza rodillo para tubos	146
Espátulas.....	186,187,216,335	Friedmann Pinzas- gubias.....	388	Guthrie Separadores, (ganchitos para nervios)	155
Espátulas abdominales	216	Fritsch Separadores.....	171	Guttman Cucharillas para secreciones	465
Espátulas abdominales e intestinales	186,187	Frosch Pinzas para huesos	384	Guyon Guía para catéteres	474
Espátulas para la íntima.....	335	Frykholm Pinzas- gubias.....	393	Guyon Instrumento para introducir catéteres	474
Espátulas pulmonares.....	334	Fuchs Pinzas hemostáticas.....	121	Guyon Pinzas- clamps para pedúnculos renales	135
Espéculos rectales	456,457	G			
Espéculos vaginales.....	351-359	Ganchos	154,155,160,340,437	H	
Espéculos y valvas vaginales.....	353-359	Ganchos para fistulas.....	340	Haberer Espátulas abdominales.....	216
Estetoscopios	267,268	Ganchos para huesos (en titanio)	154	Haight Separadores costales.....	330
Estiletes	262	Ganchos para nervios	155	Halle Cucharillas cortantes	405
Estribos para extensión	436,437	Ganchos para piel (en titanio)	154	Halsey Porta- agujas.....	222
Estuche de bolsillo.....	251	Ganchos para tendón.....	154,155	Halsey Porta- agujas CT-ORO.....	233
Estuche para suturas.....	251	Ganchos para tendón (en titanio).....	154	Halsted-Mosquito Pinzas hemostáticas	117,118
Estuches para esterilizar agujas.....	481,482	Ganchos para tracción de estribos de extensión	437	Hank Dilatadores uterinos.....	362
Exploradores para cálculos biliares.....	469,471	Ganchos para venas	160	Harken Pinzas- clamps para aurícula	311
F					
Farabeuf Legras- Periostotomos	419	Garret Dilatadores vasculares	337	Harrington-Pemberton Separadores.....	180
Farabeuf Pinzas para huesos.....	385	Gellhorn Pinzas saca- bocados para biopsia.....	345	Harrington Separadores.....	180
Farabeuf Separadores.....	188	Gelpi-Loktite Separadores.....	202	Hartmann Pinzas hemostáticas	117
Farabeuf-Collin Legras-Periostotomos	419	Gemini Pinzas para preparaciones y ligaduras	130	Hartmann Pinzas- gubias	389
Farabeuf-Lambotte Pinzas para huesos	385	Gemini-Mini Pinzas para preparar. y ligaduras	130	Hayes Atraumatic Pinzas para anastomosis del recto.....	452
G					
		Gemini Pinzas de disección	96	Heaney Pinzas- clamps para histerectomía y vaginales	140
		Gerald Pinzas de disección con dientes.....	105	Heaney Porta- agujas	224
		Gerald Pinzas de disección CT-ORO	97	Hegar Dilatadores uterinos	360,361



Hegar Porta- agujas.....	224	Jansen Pinzas- gubias.....	388,389	L	
Hegar-Baumgartner Porta- agujas.....	222	Jansen Separadores.....	191	Lahey Pinzas hemostáticas.....	134
Hegar-Baumgartner CT-ORO Porta- agujas.....	233	Javid Pinzas- clamps para carótida.....	300	Lahey Pinzas- clamps para bronquios y conducto biliar.....	134
Hegar-Vascular CT-ORO Porta- agujas.....	237	Johns-Hopkins Clamps Bulldog.....	114	Lambert-Kay Pinzas- clamps p/anastomosis de aorta.....	312
Hegenbarth Pinzas para ágrafes.....	250	Johnson Porta- agujas.....	225	Lambotte Cinceles y gubias para huesos.....	414
Heiss Pinzas hemostáticas.....	127	Jones Pinzas para de campo.....	144	Lambotte Legras- Periostotomos.....	422
Hemostáticos.....	417	Jones-Speziell Pinzas de campo, porta-tubos.....	144	Lambotte Pinzas para huesos.....	385
Henley Separadores.....	195	Joseph Tijeras finas para cirugía.....	42	Lámparas de alcohol.....	496
Hepp/Scheidel Micro- Tijeras.....	55,57	Judd-Allis Pinzas para tejidos y órganos.....	254	Landau Espéculos y valvas vaginales.....	358
Hepp/Scheidel CT-ORO Porta-agujas.....	231	Judd-Masson Separadores vesicales.....	467	Lane Destornilladores.....	433
Herrick Pinzas-clamps para pedúnculos renales.....	136	Juego para varices.....	263	Lane Pinzas de campo.....	145
Heymann Tijeras Supercut.....	70	Juegos de dilatadores.....	360-362	Lane Pinzas de disección con dientes.....	108
Heymann-Knight Tijeras nasales.....	47	Juegos para laringoscopia.....	275-280	Lane Pinzas para huesos.....	386
Heywood-Smith Pinzas para biopsia rectal.....	455	Juegos para laringoscopia para bebés y niños.....	275-280	Lane Pinzas-clamps estomacales.....	447
Hibbs Cinceles y gubias para huesos.....	415,416			Lange Pinzas para ágrafes.....	250
High Quality Tijeras.....	64	K		Lange Tijeras para vendajes.....	61
Histerómetros.....	350	Kader Espátulas.....	186	Lange-Hohmann Elevadores para huesos.....	379
Hoen Legras-Periostotomos.....	418	Kallmorgen Espéculos y valvas vaginales.....	355	Langenbeck Elevadores.....	375
Hohmann Elevadores para huesos.....	378,379	Kalt Micro- porta- agujas.....	218	Langenbeck Legras- Periostotomos.....	418,419
Hojas de afeitar.....	6	Kane Clamps umbilicales.....	366	Langenbeck Pinzas para huesos.....	384
Hojas de afeitar, Pinzas para sujetar y romper.....	6	Kaye Tijeras Supercut.....	74	Langenbeck Porta- agujas CT-ORO.....	240
Hojas de bisturíes.....	11,12	Kelly Tijeras Supercut.....	457	Langenbeck-Mini Separadores.....	157
Hojas de repuesto.....	13	Kelly Esfinteroscopios.....	457	Langenbeck Separadores.....	164,165
Hojas de sierras.....	441	Kelly Pinzas hemostáticas.....	119	Langenbeck Sierras para amputación y resección.....	427
Hoke Gubias para huesos.....	415	Kelly Pinzas para pólipos uterinos.....	344	Laringoscopios.....	275
Holzbach Separadores abdominales.....	205	Kelly Pinzas para preparaciones y ligaduras.....	138	Lawrence Pinzas para preparaciones y ligaduras.....	139
Hösel Separadores.....	170	Kelly Separadores.....	168,184	Lebsche Cinceles de esternón.....	291
Hudson Perforadores de mano.....	424	Kelly Tijeras CT-ORO.....	88	Lees Pinzas- clamps bronquiales.....	311,312
Hunt Micro- Pinzas.....	90	Kelly Tijeras para cirugía.....	31	Legras- Periostotomos.....	418-422
Hunter Pinzas depilatorias.....	110	Kelly-Rankin Pinzas hemostáticas.....	119	Legueu Separadores abdominales.....	208
Husfeldt Pinzas- clamps para carótida.....	300	Kern Pinzas para huesos.....	385	Legueu Separadores vesicales.....	467,468
		Kevoikian Curetas aspiradoras para biopsia.....	347	Leksell-Stille Pinzas- gubias.....	392
I		Kevoikian Pinzas saca- bocados para biopsia.....	346	Leland-Jones Atraumatic Pinzas-clamps cardiovasculares.....	306
Instrumental para histero- salpingografía.....	363	Key Elevadores.....	376	Lempert Cucharillas cortantes.....	403
Instrumental para perforar.....	423-426	Kielland Forceps obstétricos.....	366	Lempert Pinzas- gubias.....	389
Instrumental para suturas.....	241,242	Kilner Ganchos.....	160	Lerche Pinzas de disección con dientes.....	103
Instrumentos de circuncisión.....	474	Kilner Tijeras finas para preparación.....	43	Leriche Espátulas abdominales e intestinales.....	187
Instrumentos de uretrografía.....	474	Kirschner Estribos para extensión.....	436	Leriche Pinzas hemostáticas.....	119
Instrumentos para coger tendones.....	373,374,438,439	Kirschner Separadores abdominales.....	212,213	Lewin Pinzas para huesos.....	383
Instrumentos para el túnel del tendón.....	438,439	Kirschner Sondas conductoras.....	247	Lexer Cinceles y gubias para huesos.....	412,413
Instrumentos para exámenes y medidas.....	269,27	Kirschner Ferrozell Sondas conductoras.....	249	Lexer Tijeras CT-ORO.....	81
Instrumentos para examinar la sensibilidad.....	267	Kleinert-Kutz Instrumentos para coger tendones.....	374	Lexer Tijeras para preparaciones.....	39
Instrumentos para fibroma.....	340	Knapp Tijeras finas para cirugía.....	52	Lexer Tijeras Supercut.....	68
Instrumentos para introducir catéteres.....	474	Knowles Tijeras para vendajes.....	62	Lexer-Baby Tijeras para preparaciones.....	39
Instrumentos para medidas.....	270	Knutson Instrumento de uretrografía.....	474	Lexer-Fino Tijeras para preparaciones.....	40
Instrumentos para prostatectomía.....	464	Kocher (Ochsner) Pinzas hemostáticas.....	125,126	Lichtenberg Porta- agujas.....	227
Instrumentos para sutura.....	241,242	Kocher Pinzas hemostáticas.....	122	Lichtenberg Porta- agujas CT-ORO.....	240
Instrumentos para suturas profundas.....	242	Kocher Pinzas- clamps Atraumatic intestinales y estomacales.....	450,451	Lichtwitz Trócares.....	283
Instrumentos para uñas.....	440,441	Kocher Pinzas- clamps intestinales.....	445	Limas para huesos.....	434
Iowa Pinzas para la vesícula amniótica.....	342	Kocher Separadores.....	161,167,172	Limas para uñas.....	493
Israel Separadores.....	163	Kocher Sparadores vesicales.....	468	Limpiadores de pipetas.....	495,497
Ives-Fansler Anuscopios.....	457	Kocher-Atraumatic Pinzas- clamps intestinales.....	450,451	Lister Pinzas para pólipos y vendajes.....	148
		Kocher-Langenbeck Separadores.....	165	Lister Tijeras para vendajes.....	61
J		Kocher-Nippon Pinzas hemostáticas.....	123	Lister Tijeras para vendajes CT-ORO.....	64
Jackson Espéculos y valvas vaginales.....	353	Koerte Espátulas abdominales e intestinales.....	186	Lister Tijeras Supercut.....	73
Jackson-Burrows Separadores para la tráquea.....	202	Koerte Separadores.....	162	Lister-Excentric Tijeras para vendajes.....	62
Jacobs Perforadores iniciales p/pinzas de tracción craneal.....	425	Kogan Endospeculos.....	359	Liston Pinzas cortantes para huesos.....	394
Jacobs Pinzas para coger el cuello del útero.....	343	König Sondas conductoras.....	249	Liston-Key Pinzas cortantes para huesos.....	396
Jacobson Micro- tijeras.....	53	Konrich Cajas para esterilización.....	479	Littauer Pinzas depilatorias.....	110
Jacobson-Adson Pinzas hemostáticas.....	121	Krause Trócares.....	283	Littauer Tijeras para ligaduras.....	60
Jameson Tijeras para neurocirugía.....	46	Kristeller Espéculos y valvas vaginales.....	353-355	Littler Tijeras para ligaduras.....	60
Jamison Porta- agujas.....	224	Kronecker Agujas para ligaduras.....	243	Llaves de tuercas.....	436
Jansen Pinzas auriculares.....	112	Kuemmel Espátulas.....	186	Lockhart-Mummary Estiletes.....	262
				Locklin Tijeras CT-ORO.....	88
				Lockwood Pinzas para tejidos y órganos.....	255



Logan Separadores	191	Mayo-Stille Tijeras para alta calidad	65	Mini-Roux Separadores	189
Lorenz Tijeras para vendajes	62	Mayo-Stille Tijeras para preparaciones	26,27	Mixer Baby Pinzas hemostáticas	132
Lorna Pinzas de campo	145	Mayo-Stille Tijeras Supercut	66	Mixer Pinzas hemostáticas	127,133,134
Loute Tensores tierra- hilo	435	Mazos	428-432	Mixer Pinzas para cálculos biliares	463
Lovelace Pinzas hemostáticas	120	Mc Donald Elevadores	377	Mixer Pinzas-clamps p/bronquios y conducto biliar	133,134
Lovelace Pinzas para tejidos y órganos	257	Mc Indoe Pinzas de disección	95	Mixer-O'Shaugnessy Pinzas hemostáticas	133
Lower Pinzas hemostáticas	134	Mc Indoe Pinzas de disección CT-ORO	97	Mixer-O'Shaugnessy Pinzas- clamps para	133
Lower Pinzas- clamps para bronquios y conducto biliar	134	Mc Indoe Tijeras para la cirugía cardiovascular	44	bronquios y conducto biliar	
Lowman Clamps porta-huesos	381	Mc Intosh Juegos para laringoscopia	277	Mock Cánulas vasculares para irrigación	338
Lucae Martillos	428	Mc Quigg-Mixer Pinzas para conducto biliar	134	Mod.CEATEC Porta-algodones	264
Lucae Pinzas auriculares	112	Mead Martillos	429	Mod.Martin Sondas conductoras	247
Luer Pinzas- gubias	390	Mead Pinzas- gubias	389	Mod.Michel Pinzas para ágrafes	250
Luer-Koerte Cucharillas p/coger cálculos biliares	469	Meatotomos, instrumentos para la urología	465	Mod.Muenchen Curetas aspiradoras para biopsia	347
		Mechas de repuesto para lámparas de alcohol	496	Mod.Suoco Cucharillas cortantes	403
		Meeker Pinzas para preparaciones y ligaduras	139	Mod.Tübingen Separadores	173
		Meniscomotos	372	Mod.USA Cucharillas cortantes	405
M		Mercedes Separadores torácicos	333	Mod.USA-Taylor Martillos de percusión	266
Magill Pinzas para catéteres	274	Methot Distribuidores de algodón	490	Mod.USA Tijeras umbilicales	49
Maisonneuve Uretrotomos	473	Methot Recipientes para desperdicios	490	Mod.Wien Tuerce- hilos	249
Mangos de bisturíes	7-10	Metzenbaum Porta- agujas	223,239	Moeltgen Goniómetro para miembros	269
Mangos de pila (sin pila) luz fría	279	Metzenbaum Tijeras CT-ORO	78,79,84	Mollison Separadores	194
Mangos de pila, luz fría con acumulador recargable	279	Metzenbaum Tijeras para preparaciones	31,32,37	Moore Cucharillas para coger cálculos biliares	470
Mangos para desoblitadores de vasos	264	Metzenbaum-Fino Tijeras CT-ORO	82,83,85	Moore Perforadores de mano	425
Manómetros de mercurio p/ la presión de la sangre	271	Metzenbaum-Fino Tijeras para preparaciones	40,41	Morris-De Bakey Pinzas- clamps para aorta	313
Manoplas de plomo	440	Metzenbaum-Fino Tijeras Supercut	67,68	Morse-Favaloro Separadores costales	330
Markwalder Pinzas cortantes para huesos	394	Metzenbaum-Lahey Tijeras CT-ORO	84	Mosquito-Dandy Pinzas hemostáticas	120
Marquardt Pinzas- gubias	391	Metzenbaum-Nelson Tijeras p/ preparaciones	33-36	Moynihan Pinzas- clamps	142
Martel Pinzas para tejidos y órganos	117	Metzenbaum-Nelson Tijeras Supercut	68	Museux Pinzas para tejidos y órganos	259
Martillos	266,428-432	Metzenbaum-S Tijeras CT-ORO	80		
Martillos de percusión	266	Metzenbaum-Thorek Tijeras CT-ORO	80		
Martin Espátulas abdominales	216	Meyerding Separadores	157	N	
Martin (Simpson) Histerómetros	350	Michel Ágrafes (grapas)	251	Nabatoff Juego sondas para varices	263
Martin Pelvimetros	369	Michel Pinzas para ágrafes	250	Naegle Forceps obstétricos	366
Martin Pinzas para menisco y cartilago	382	Micro Elevadores	376	Neff Bisturíes para meniscos	372
Martin Separadores	173	Micro-Adson Pinzas de disección con dientes	106	Negus Pinzas para coger las amígdalas	139
Martini Cucharillas cortantes	406	Micro-Adson Pinzas de disección CT-ORO	98	Neivert Porta- agujas	222
Mass.-General-Hospital Porta- agujas	223	Micro- Pinzas	90,92	Nélaton Estiletes	262
Masson Porta- agujas	224	Micro- Pinzas para poner ligaduras	92	Nelson Pinzas de disección con dientes	108
Masson Porta- agujas CT-ORO	235	Micro- Porta- agujas	218-221	Nelson Trócares	282
Mathieu Espéculos rectales	456	Micro- Tijeras	54-58	Newmann Proctoscopios	457
Mathieu Espéculos y valvas vaginales	356	Microhojas	6	Nissen Pinzas-clamps para conducto biliar	137
Mathieu Instrumentos para introducir catéteres	465	Microvascular Porta- agujas CT-ORO	238	Northbent Tijeras para ligaduras	60
Mathieu Pinzas para cuerpos extraños	465	Middeldorpf Separadores	167,171	Noto Pinzas para pólipos uterinos	344
Mathieu Porta- agujas	226,227	Mikulicz Pinzas- clamps para peritoneo	143	Novak Curetas aspiradoras para biopsia	347
Mathieu Porta- agujas CT-ORO	239	Mikulicz Retractores de hígado	184	Nuboer Tubos de aspiración	286
Mathieu Separadores	190	Mikulicz Separadores	184	Nussbaum Pinzas-clamps intestinales	447
Mathieu-Kocher Porta- agujas CT-ORO	239	Miller Juegos para laringoscopia	275		
Matson Legras-Periototomos	422	Miller Laringoscopios	275	O	
Mayfield Pinzas- gubias	391	Miller-Baby Juegos para laringoscopia p/bebés y niños	275	O'Connor Separadores, (ganchitos cutáneos, erinas)	155
Mayo Cucharillas para coger cálculos biliares	470	Milligan Separadores	195	O'Sullivan-O'Connor Espéculos vaginales	359
Mayo Imperdibles porta-instrumentos p/esterilización	476	Millin Dilatadores para el cuello vesical con luz fría	468	de retención automática	
Mayo Tijeras CT-ORO	76	Millin Dilatadores para el cuello vesical	467,468	O'Sullivan-O'Connor Separadores abdominales	211
Mayo Tijeras para preparaciones	24	Millin Pinzas capsulares	464	Ochsner Pinzas para ágrafes	250
Mayo Tijeras Supercut	66	Millin Pinzas capsulares atraumáticas	464	Ochsner Trócares	282
Mayo-Adams Separadores abdominales	203	Millin Pinzas para coger los lóbulos anteriores	464	Ochsner Pinzas- clamps atrauma, para aorta	297
Mayo-Blake Pinzas para cálculos biliares	463	Millin Pinzas para próstata	464	Oehler Pinzas de disección CT-ORO	99
Mayo-Harrington Tijeras para preparaciones	25	Millin Pinzas porta- ligaduras supra- pubiana	464	Olivecrona Pinzas-gubias	390
Mayo-Harrington Tijeras CT-ORO	86	Millin Separadores vesicales	467,468	Olivecrona Tijeras para nervio trigémino	46
Mayo-Hegar (Heaney) Porta- agujas CT-ORO	235	Mini-Adson Pinzas de disección	95	Ollier Separadores	162
Mayo-Hegar Porta- agujas	223,224	Mini-Adson Pinzas de disección con dientes	106	Olsen-Hegar Porta- agujas	226
Mayo-Hegar Porta- agujas CT-ORO	234	Mini-Friedmann Pinzas- gubias	388	Olsen-Hegar Porta- agujas CT-ORO	238
Mayo-Lexer Tijeras CT-ORO	78,81	Mini-Gemini Pinzas p/ preparaciones y ligaduras	130	Ombredanne Martillos	432
Mayo-Noble Tijeras para ginecología	28	Mini-Hohmann Elevadores para huesos	377	Otis Uretrotomos	473
Mayo-Robson Pinzas- clamps intestinales	444	Mini-Lambotte Cinceles y gubias para huesos	413	Overholt-Geissendoerfer Pinzas p/preparaciones	129
Mayo-Robson- Atraumatic Pinzas-clamps intestinales	450	Mini-Langenbeck Separadores	157	y ligaduras	
Mayo-Russ. Pinzas de disección con dientes	108	Mini-Lexer Cinceles y gubias para huesos	412		
Mayo-Stille Tijeras CT-ORO	78				



Overholt-Mixter Pinzas para preparac. y ligaduras	128	Pinzas para biopsia	345,346	Pinzas- clamps para aneurisma de aorta	307,308,313
Overholt-S Pinzas para preparaciones y ligaduras	127	Pinzas para biopsia rectal, (sacabocado)	454,455	Pinzas- clamps para aneurisma de la arteria iliaca	313
P					
Palanganas	478	Pinzas para bronquios y conducto biliar	133,134,137	Pinzas- clamps para aorta	297,313,323,309,310
Parametrium Tijeras CT-ORO	86	Pinzas para cálculos biliares	463	Pinzas- clamps para arteria renal	306
Parametrium Tijeras para histerectomía	85	Pinzas para cálculos renales	462	Pinzas- clamps para aurícula	311
Parker Separadores	189	Pinzas para catéteres	274	Pinzas- clamps para carótida	300
Parker-Langenbeck Separadores	190	Pinzas para cerrar los clamps	448	Pinzas- clamps para coartación	304,314,320
Parker-Mott Separadores	189	Pinzas para cerrar y sostener los clamps	448	Pinzas- clamps para iliaca	320
Partsch Cinceles para huesos	407,408	Pinzas para coger	398	Pinzas- clamps para la profunda	299
Partsch Martillos	429	Pinzas para coger el cuello del útero	341-343	Pinzas- clamps para ligaduras	309,318,321
Payr Pinzas- clamps estomacales	446	Pinzas para coger los lóbulos anteriores	464	Pinzas- clamps para oclusión tangencial	310,322
Payr Sondas conductoras	249	Pinzas para cuerpos extraños	148,465	Pinzas- clamps para pediátricos	320,323-326
Payr-Baby Pinzas- clamps intestinales	446	Pinzas para desechos	498	Pinzas- clamps para peritoneo	143
Péan (Rochester) Pinzas hemostáticas	125,126	Pinzas para el útero	344	Pinzas- clamps para preparaciones y ligaduras	305
Péan Pinzas hemostáticas	122	Pinzas para espinas	110,111	Pinzas- clamps para profunda	299
Péan-Nippon Pinzas hemostáticas	123	Pinzas para esponjas	148-151	Pinzas- clamps para recién nacidos	323-326
Pederson Espéculos vaginales	352	Pinzas para esterilización	476	Pinzas- clamps para usos varios	315,321
Peers-Bertram Pinzas de campo	145	Pinzas para histerectomía y vaginales	140,142	Pinzas- clamps para vasos periféricos	299,306
Pelvímetros	369	Pinzas para histerectomía Atraumatic	141	Pinzas- clamps vaginales	140-142
Penner Pinzas para extraer uñas	441	Pinzas para huesos	381-387	Pinzas- compás para medir vasos	301
Pennington Pinzas para tejidos y órganos	257	Pinzas para interlazar tendones	374	Pinzas- gubias	388-393
Percy Retractores para amputación	381	Pinzas para menisco y cartílago	382,383	Pistola- lavatoria de chorro de agua con varias toberas	494
Perforadores	418-422,424-426,440	Pinzas para la vesícula amniótica	342	Placas para extender la piel	13
Perforadores de uñas	440	Pinzas para nefrostomía	463	Plato para medicinas	487
Perforadores iniciales para pinzas de		Pinzas para órganos	254-259	Plester Separadores	194
tracción craneal	418-422	Pinzas para patela	384	Pollosen Separadores	179
Perforadores manuales	424-426	Pinzas para pedúnculos renales	135,136	Poole Tubos de aspiración	285
Periostotomos	418-422	Pinzas para pedúnculos renales Atraumatic	135	Poppen Tubos de aspiración	283
Perthes Escariadores	423	Pinzas para pericráneo	117,367	Porta- agujas	218-240
Pestalozza Curetas para aborto	368	Pinzas para pólipos	148-151	Porta- agujas CT-ORO	231-240
Phaneuf Pinzas para histerectomía	140	Pinzas para pólipos uterinos	344	Porta- agujas, Micro	218-221
Philips Destornilladores	433	Pinzas para pólipos y vendajes	148-151	Porta- algodones	264
Pierce Trócares	283	Pinzas para poner clips	302,303	Porta- clamps	448
Piezas de conexión para tubos, Ginecología	350	Pinzas para preparaciones y ligaduras	127-132,138,139,305	Porta- instrumentos	476
Pinard Estetoscopios	267	Pinzas para próstata	464	Porta- ligaduras	249
Pinzas aplicadoras para clamps Bulldog	302,303	Pinzas para sujetar y romper hoja de afeitar	6	Potts Atraumatic Pinzas-clamps para anastomosis	305
Pinzas Atraumatic de titanio	293	Pinzas para suturas	250	Potts Atraumatic Pinzas- clamps para coartación	304
Pinzas auriculares	112	Pinzas para taponamientos nasales	112	Potts (De Bakey) Pinzas-clamps para coartación	304
Pinzas Bulldog	114,115,293,295,296	Pinzas para tampones	148-151	Potts Micro- tijeras	53
Pinzas Bulldog Atraumatic	115,295,296,302,303	Pinzas para tejidos	254-259	Potts-Smith Pinzas de disección	96
Pinzas Bulldog Atraumatic titanio	293	Pinzas para tejidos y órganos	254-259	Potts-Smith Pinzas de disección con dientes	105
Pinzas capsulares	464	Pinzas para tejidos y órganos Atraumatic	256,258	Potts-Smith Pinzas de disección CT-ORO	99
Pinzas capsulares Atraumatic	464	Pinzas para tejidos y órganos CT-ORO	256	Potts-Smith Tijeras para la cirugía cardiovascular	44,45
Pinzas capsulares para prostatectomía retropúbica	464	Pinzas para tendones	374	Potts-Smith Tijeras Supercut	69
Pinzas corta- uñas	492,493	Pinzas para torcer hilos CT-ORO	397	Pozzi Pinzas para tejidos y órganos	259
Pinzas cortantes para huesos	394-396	Pinzas para tubos	144,146	Pratt Espéculos rectales	456
Pinzas cuticulares	493	Pinzas para tumores	91	Pratt Pinzas hemorroidales	455
Pinzas de campo	144-146	Pinzas para vendajes	148-151	Presbyterian Pinzas de campo	146
Pinzas de disección	93-96	Pinzas para vendajes con tapa integrada	484	Price-Thomas Pinzas- clamps bronquiales	294
Pinzas de disección Atraumatic	292	Pinzas porta- huesos	381-387	Proctoscopios	457
Pinzas de disección con dientes	101-108	Pinzas porta- ligaduras supra- pubiana	464	Providence-Hospital pinzas hemostáticas	119
Pinzas de disección CT-ORO	97-100	Pinzas relojero	107	Punzones	417
Pinzas de disección, modelos finos	109	Pinzas tangenciales	310,322	Putti Raspas	417
Pinzas de relojero	107	Pinzas, Micro	90,92		
Pinzas depilatorias	110,111	Pinzas, Modelos finos	109	R	
Pinzas hemorroidales	455	Pinzas- clamps	140,142,143,297-326	Rabiner Martillos de percusión	266
Pinzas hemostáticas	116-129,131-134,138,139	Pinzas- clamps bronquiales	311,312,294	Radolf Pinzas para extraer uñas	441
Pinzas hemostáticas Atraumatic	297,316	Pinzas- clamps c		Ragnell (Killner) Tijeras CT-ORO	88
Pinzas intestinales	444-446,448-452	ardiovasculares Atraumatic	297-301,304-326	Ragnell-Davis Separadores	158
Pinzas intestinales Atraumatic	449-452	Pinzas- clamps estomacales	446,447,449-451	Ralk Perforadores de mano	426
Pinzas para aborto	367	Pinzas- clamps intestinales	444-446,448-452	Rampley Pinzas para vendajes	151
Pinzas para agrafes	250	Pinzas- clamps intestinales y		Randall Curetas para biopsia	347
Pinzas para anastomosis rectal Atraumatic	452,453	estomacales Atraumatic	449-452	Randall Pinzas para cálculos renales	462
		Pinzas- clamps modelos muy delicados	325,326	Raspas para huesos	417
		Pinzas- clamps para anastomosis	305,318,322,448	Raspatorios	417
		Pinzas- clamps para anastomosis de aorta	312		



Recamier Curetas uterinas.....	349	Schimmelbusch Cajas para esterilización.....	479	Sierras para abrir anillos.....	441
Recipientes.....	487,488,490	Schink Dermatomos.....	13	Sierras para amputación y resección.....	427
Recipientes para algodón, tampones.....	487	Schmid Cánulas vasculares para irrigación.....	338	Simon Cucharillas cortantes.....	404
Recipientes para desperdicios.....	490	Schmieden Instrumentos para suturas.....	243	Simon Cucharillas y curetas uterinas.....	348
Rectoscopios.....	459	Schmieden Sondas conductoras.....	248	Simon Ganchos para fistulas.....	340
Redon Agujas de guía.....	287	Schmieden-Dick Instrumentos para suturas.....	243	Simon Separadores.....	173
Reill Pinzas para huesos.....	383	Schmieden-Payr Sondas conductoras.....	248	Simpson Forceps obstétricos.....	366
Resano Atrauma Pinzas para anastomosis del recto.....	453	Schmieden-Taylor Tijeras para dura- madre.....	46	Simpson-Braun Forceps obstétricos.....	366
Retractores.....	381	Schmidt Pinzas hemostáticas.....	121	Simpson-Luikart Forceps obstétricos.....	366
Retractores de hígado.....	184	Schmidt Pinzas para coger las amígdalas.....	121	Sims Curetas uterinas.....	349
Retractores de pelvis.....	185	Schoemaker-Loth Tijeras para ligaduras.....	60	Sims Espéculos rectales.....	456
Retractores para amputación.....	381	Schroeder Cucharillas y curetas uterinas.....	348	Sims Espéculos vaginales.....	353
Retractores para venas e hilares.....	159	Schroeder Pinzas para tejidos y órganos.....	259	Sims Histerómetros.....	350
Reverdin Agujas.....	241,242	Schroeder Pinzas para coger el cuello del útero.....	342	Sims CT-ORO Tijeras para útero.....	86
Reverdin Espátulas abdominales.....	216	Schubert Pinzas saca-bocados para biopsia.....	345,346	Sims Tijeras para ginecología.....	29,85
Reynolds Tijeras finas para cirugía.....	43	Schumacher Tijeras umbilicales.....	49	Sims Tijeras Supercut.....	67
Reynolds Tijeras Supercut.....	68	Schultze Instrumental para histero-salpingografía.....	363	Sims-Maier Pinzas para pólipos y vendajes.....	149
Ricard Separadores abdominales.....	205	Schwedisch Pattern Cucharillas cortantes.....	403	Singley-Tuttle Pinzas de disección.....	108
Richardson Separadores.....	168	Scoville Separadores para laminectomía.....	215	Skene Pinzas para coger el cuello del útero.....	342
Richardson-Eastman Separadores.....	168	Scudder Pinzas-clamps intestinales.....	446	Smillie Bisturíes para meniscos.....	372
Richter-Heath Pinzas para ágrafes.....	250	Scudder Pinzas-clamps-Atraumatic intestinales.....	451	Smillie Separadores espinales.....	380
Richter Tijeras para incisión.....	23	Sedillot Legras-Periostotomos.....	419	Smith-Petersen Cinceles y gubias para huesos.....	414,415
Robb Espátulas y dilatadores para la íntima.....	335	Segond Cuchillos para fibroma.....	340	Somer Pinzas para el útero.....	344
Roberts Pinzas hemostáticas.....	128	Segond-Landau Pinzas-clamps para histerectomía.....	142	Snitman Separadores.....	192
Rochard Separadores abdominales.....	214	Sellheim Separadores para la salida de cabeza.....	368	Sondas.....	262
Rochester-Carmalt Pinzas hemostáticas.....	121	Sellers Aproximadores para costillas.....	334	Sondas abotonadas.....	262
Roeder Pinzas de campo.....	144	Semb Legras-Periostotomos.....	422	Sondas acanaladas.....	262
Rogers Pinzas- clamps para histerectomía Atraumatic.....	141	Semb Pinzas cortantes para huesos.....	396	Sondas conductoras.....	247-249
Rogge Pinzas para esterilización.....	476	Semb Pinzas para huesos.....	385	Sondas metálicas.....	472
Ross Separadores.....	178	Semb Pinzas-clamps bronquiales.....	294	Sondas para cálculos biliares.....	471
Roux Separadores.....	188	Semb Pinzas-gubias.....	392	Sondas para endarterectomía.....	264
Roux (Baby) Separadores.....	189	Semken Pinzas de disección.....	95	Sondas para varices.....	263
Roux (Mini) Separadores.....	189	Semken Pinzas de disección con dientes.....	104	Spencer tijeras para ligaduras.....	60
Rumel Pinzas para preparaciones y ligaduras.....	131	Semken Pinzas de disección CT-ORO.....	97	Spencer-Wells Pinzas hemostáticas.....	116
Rumel-Belmont Torniquetes.....	338	Semm Espéculos vaginales.....	352	Spezial Pinzas de campo.....	146
Ruskin Pinzas- gubias.....	391	Senn-Green Separadores.....	158	Spezial Pinzas de campo con estribo de protección.....	146
Ruskin-Liston Pinzas cortantes para huesos.....	395	Senn-Mueller Separadores.....	158	Spratt cucharillas cortantes.....	402
Russ.Modell Pinzas de disección con dientes.....	107	Separadores (en titanio).....	154	St.Marks Retractores de pelvis.....	185
Ryder Porta- agujas CT-ORO.....	235	Separadores.....	154-216	Stacke Estiletes.....	262
Ryder-Vascular Porta- agujas CT-ORO.....	236	Separadores abdominales.....	203-214	Standard Mangos de bisturíes.....	7,9
		Separadores abdominales, rayos X.....	213	Standard Pinzas de disección.....	93,94
S		Separadores con hoja en forma de silla.....	156	Standard Pinzas de disección con dientes.....	101
Sachse Meatótomos.....	465	Separadores costales.....	330-333	Standard Pinzas-gubias.....	388
Saenger Pinzas para aborto.....	367	Separadores costales de aluminio.....	327-329	Standard Pinzas hemostáticas.....	116
Salenius Bisturíes para meniscos.....	372	Separadores espinales.....	380	Standard Tijeras CT-ORO.....	75
Salpingógrafo.....	363	Separadores obstétricos.....	368	Standard Tijeras para cirugía.....	16-21,65
Santulli Atrauma Clamps Bulldog.....	295	Separadores para dedos.....	201	Sandard Tijeras Supercut.....	66
Sanvenero Tijeras finas para cirugía.....	42	Separadores para el cuello vesical.....	467	Standard Trócares.....	282
Sarot Pinzas hemostáticas.....	128	Separadores para hemilaminectomía.....	200	Staude-Moore Pinzas p/coger el cuello del útero.....	341
Sarot Porta- agujas CT-ORO.....	234	Separadores para la próstata.....	464,466	Steinmann Instrumentos para coger tendones.....	373
Satinsky (De Bakey) Pinzas- clamps para oclusión tangencial.....	310	Separadores para la salida de cabeza.....	368	Stellbrink Pinzas-gubias.....	388
Satinsky Tijeras para la cirugía cardiovascular.....	44	Separadores para laminectomía.....	215	Stevens Tijeras Supercut.....	69
Satterlee Sierras para amputación y resección.....	427	Separadores para menisco.....	380	Stevens Tijeras finas para cirugía.....	52
Sauerbruch Estuches para esterilizar agujas.....	481	Separadores para pelvis.....	185	Stevens Tijeras Supercut.....	69
Sauerbruch Pinzas para desechos.....	498	Separadores para próstata.....	466	Stieglitz Pinzas para espinas.....	111
Sauerbruch Pinzas- gubias.....	393	Separadores para rodilla.....	380	Stille Cizallas para vendajes.....	63
Sauerbruch Separadores.....	175,178	Separadores para tendones.....	438-439	Stille Cinceles y gubias para huesos.....	409,41
Sauerbruch Costótomos (tijeras de esternón).....	291	Separadores para tórax.....	333	Stille Perforadores de manos.....	424
Scalp-Contour Separadores.....	192	Separadores rectales.....	457	Stille Pinzas-clamps para pedúnculos renales.....	136
Schaedel Pinzas de campo.....	144	Separadores vesicales.....	467,468	Stille Pinzas de disección.....	94
Schede Cucharillas cortantes.....	402	Seyffert Espéculos vaginales.....	352	Stille Pinzas de disección con dientes.....	103
Scheibe Pinzas Atraumatic para tejidos y órganos.....	258	Shaaf Pinzas depilatorias.....	110	Stille Pinzas-gubias.....	392
Scherbak Espéculos vaginales.....	357	Shea Tijeras finas para cirugía.....	43	Stille-Barraya Pinzas de disección con dientes.....	103
Scherbak Pesos para espéculos vaginales.....	357	Siebold Tijeras para ginecología.....	30	Stille-Liston Pinzas cortantes para huesos.....	395
		Siebold Tijeras Supercut.....	67	Stille-Luer Pinzas-gubias.....	393
		Sierras.....	427,441	Stille-Ruskin Pinzas-gubias.....	392



tockmann Compresores uterales.....	465	Tijeras para uñas.....	492	Vollmar Cánulas vasculares para irrigación.....	338
Stone Pinzas de disección con dientes.....	103	Tijeras para vendajes.....	61-63	Vollmar Sondas para endarterectomía.....	264
Stone Pinzas para cerrar y sostener los clamps.....	448	Tijeras CT-ORO para vendajes.....	64		
Stone-Watt Clamps para intestino (anastomosis).....	448	Tijeras umbilicales.....	49	W	
Strandell-Stille Separadores.....	160	Tiramomas para fibroma.....	340	Wachenfeldt Pinzas para ágrafes.....	250
Stratte Porta-agujas.....	226	Titan Clamps Bulldog Atraumatic.....	293	Wagner Tijeras finas para cirugía.....	50
Stratte Porta-agujas con fillos TC.....	237	Titan Elevadores.....	376	Wagner Tijeras Supercut.....	71
Strauss Compresores uterales.....	465	Titan Disectores para tejidos blandos.....	376	Walb Cuchillos para órganos.....	4
Strauss Rectoscopios.....	459	Titan Ganchos para huesos.....	154	Walb Cuchillos, post mortem.....	4
Strully Tijeras para neurocirugía.....	46	Titan Separadores.....	154	Waldmann Tijeras para episiotomía.....	48
Subramanian Pinzas-clamps para aorta.....	513	Toberas para pistola-lavatoria.....	495	Waldmann Tijeras Supercut.....	70
Subramanian-Miniature Pinzas-clamps para aorta.....	513	Toennis Pinzas para preparaciones y ligaduras.....	131	Wallich Cucharillas para abortos.....	368
para pediátricos y recién nacidos.....		Toennis Porta-agujas.....	227	Walter-Carmalt Pinzas para espinas.....	110
Suoco Mod. Cucharillas cortantes.....	403	Toennis CT-ORO Porta-agujas.....	240	Walton Pinzas para pólipos y vendajes.....	148
Sujetador de mano.....	440	Toennis Tijeras para neurocirugía.....	46	Walton Sierras para abrir anillos.....	441
Supercut Tijeras.....	65-72	Toennis-Adson CT-ORO Tijeras.....	84	Wangensteen Pinzas de disección.....	96
		Toennis-Adson Tijeras para preparaciones.....	46	Wangensteen Pinzas de disección CT-ORO.....	100
		Tohoku Pinzas de campo.....	145	Wangensteen Porta-agujas.....	225
		Tornado Tijeras para vendajes.....	62	Wangenstein Porta-agujas CT-ORO.....	236
		Torniquetes.....	338	Wartenberg Instrumentos p/examinar la sensibilidad.....	267
T		Townley Calibradores.....	269	Wassmund Separadores.....	162
Tambores para esterilización.....	479	Trélat Espéculos vaginales.....	352	Watson-Cheyne Elevadores.....	377
Tarros.....	484	Trocares.....	282-283	Waugh Pinzas de disección.....	96
Taylor Mod.USA Martillos de percusión.....	266	Troeltsch (Wilde) Pinzas auriculares.....	112	Waugh Pinzas de disección con dientes.....	105
Taylor Pinzas de disección.....	95	Troeltsch Pinzas para taponamientos nasales.....	112	Weber Instrumentos p/examinar la sensibilidad.....	267
Taylor Pinzas de disección con dientes.....	104	Trotter Pinzas-gubias.....	390	Weber Pinzas-clamps para aorta.....	310
Taylor Separadores espinales.....	380	Troutman-Chris Pinzas p/sujetar y romper		Webster Porta-agujas.....	222
Teale Pinzas para coger el cuello del útero.....	342	hojas de afeitar.....	6	Webster Porta-agujas CT-ORO.....	233
Tensores cierra-hilos.....	435	Tubbs Dilatadores para estenosis mitral.....	336	Weissbarth Espéculos vaginales.....	357
Tensores de taladros filiformes.....	436	Tübingen Mod. Separadores.....	173	Weitlaner Separadores.....	193
Thoms-Allis Pinzas para tejidos y órganos.....	255	Tubos de aspiración.....	283-286	Weitlaner-Baby Separadores.....	195
Thoms-Gaylor Pinzas saca-bocados para biopsia.....	345	Tubos de aspiración micro para cono Luer.....	284	Weitlaner-Loktite Separadores.....	193
Thomson-Walker Separadores vesicales.....	467	Tuerce-hilos.....	249	Weitlaner-Wullstein Separadores.....	194
Tornado Tijeras para vendajes.....	63	Tuffier Pinzas para tejidos y órganos.....	257	Werheim Pinzas-clamps p/histerectomía	
Thorek Tijeras para preparaciones.....	44	Tuffier Separadores.....	172	y vaginales.....	140,142
Tijeras.....	16-88	Tuffier Separadores costales.....	332	Werheim Tijeras para ginecología.....	28
Tijeras con corte supercut.....	66-73	Turnbull Pinzas corta-uñas.....	493	Werheim-Cullen Pinzas-clamps vaginales.....	140
Tijeras CT-ORO.....	75-878			Westcott Micro-Tijeras.....	53
Tijeras CT-ORO para cortar alambre.....	88	U		Wickström Pinzas hemostáticas.....	133
Tijeras CT-ORO para útero.....	29	Ulrich Pinzas para huesos.....	386	Wien Mod., Tuerce-hilos.....	249
Tijeras CT-ORO para vendajes.....	64	Ulrich Pinzas para polipos y vendajes.....	148	Williams Pinzas para tejidos y órganos.....	255
Tijeras cuticulares.....	50-52	Universal Tijeras para cortar alambre.....	88	Williger Cucharillas cortantes.....	403,406
Tijeras de disección.....	43	Universal Tijeras para ligaduras.....	61	Williger Elevadores.....	376
Tijeras de esternón.....	291	Universal Trocares.....	282	Williger Legras-Periostotomos.....	421
Tijeras finas para cirugía.....	42,43,50-52	Uretotomos.....	473	Williger Martillos.....	428
Tijeras finas para preparación.....	43			Winter Pinzas para aborto.....	367
Tijeras High-quality.....	65	V		Wullstein Tubos de aspiración.....	284
Tijeras, Micro.....	54-58	V. Petz Aparatos para suturar estómago e intestinos.....	458		
Tijeras microscópicas de disección.....	55	Valleix Histerómetros.....	350	Y	
Tijeras nasales.....	47	Valvas laterales intercambiables para.....	206,207	Yankauer Tubos de aspiración.....	284
Tijeras para amígdalas.....	47	separadores abdominales y de costillas.....	329,331,333	Yasargil Micro- Pinzas.....	90
Tijeras para cirugía.....	16-22	Valvas para separadores costales.....	329,331,333	Yasargil Tubos de aspiración.....	284
Tijeras para cirugía cardiovascular.....	44-45	Van Buren Bujías dilatadoras.....	472	Yeoman Pinzas (sacabocados) para biopsia rectal.....	454
Tijeras para cirugía neurocirugía.....	46	Van Buren Pinzas para huesos.....	381	Young Instrumentos para suturas profundas.....	242
Tijeras para dura-madre.....	46	Van Doren Pinzas saca-bocados para biopsia.....	345	Young Separadores para la próstata.....	466
Tijeras para enterotomía.....	59	Vasos graduados.....	487		
Tijeras para enucleación.....	52	Veidenheimer Atraumatic Pinzas para		Z	
Tijeras para episiotomía.....	48	anastomosis del recto.....	453	Zaufal-Jansen Pinzas-gubias.....	391
Tijeras para estrabismo.....	52	Verbrugge Pinzas para huesos.....	387	Zenker Pinzas para preparaciones y ligaduras.....	132
Tijeras para ginecología.....	28-30	Vernier Calibradores.....	270	Zenker Separadores.....	166
Tijeras para histerectomía.....	86	Vickers Low-Profile Separadores.....	201	Zweifel Porta-agujas CT-ORO.....	240
Tijeras para huesos.....	290-291	Vickers Martillos.....	432		
Tijeras para incisión.....	23	Vickers Separadores para dedos.....	201		
Tijeras para la cirugía cardiovascular.....	44,45	Virchow Cuchillos para cartílagos.....	3		
Tijeras para ligaduras.....	60	Virchow Cuchillos para cerebro.....	4		
Tijeras para nervio trigémino.....	46	Volkman Cucharillas cortantes.....	401,402,405,406		
Tijeras para nervios.....	37	Volkman Separadores.....	160,161		
Tijeras para preparaciones.....	24-27,31-39				
Tijeras para preparaciones, modelos delgados.....	40-41				
Tijeras para suturas.....	77				
Tijeras para tenotomía.....	52				





AA		AA 109.09	8	AA 195.19	28	AA 324.16	40	AA 505.14	47
AA 002.01	2	AA 109.11	21	AA 195.22	28	AA 325.16	40	AA 507.15	47
AA 002.02	2	AA 109.13	21	AA 200.20	29	AA 326.14	40	AA 509.16	47
AA 002.03	2	AA 109.14	21	AA 200.23	29	AA 327.14	40	AA 511.18	47
AA 002.04	2	AA 109.15	21	AA 203.20	29	AA 328.14	40	AA 531.18	48
AA 002.05	2	AA 109.16	21	AA 203.23	29	AA 329.14	40	AA 535.14	48
AA 004.01	2	AA 120.14	22	AA 205.24	30	AA 330.18	41	AA 537.22	48
AA 004.02	2	AA 122.14	22	AA 208.17	30	AA 330.20	41	AA 545.10	49
AA 004.03	2	AA 124.14	22	AA 209.17	30	AA 330.23	41	AA 547.16	49
AA 004.04	2	AA 125.14	22	AA 226.16	31	AA 331.18	41	AA 551.13	49
AA 004.05	2	AA 127.14	22	AA 226.18	31	AA 331.20	41	AA 551.16	49
AA 004.06	2	AA 129.14	22	AA 227.16	31	AA 331.23	41	AA 553.13	49
AA 004.07	2	AA 130.03	9	AA 227.18	31	AA 332.18	41	AA 553.16	49
AA 004.08	2	AA 130.04	9	AA 248.11	31	AA 332.20	41	AA 566.13	50
AA 004.09	2	AA 130.05	9	AA 249.11	31	AA 332.23	41	AA 567.13	50
AA 023.10	3	AA 133.31	9	AA 250.14	32	AA 333.18	41	AA 570.12	50
AA 033.08	3	AA 133.35	9	AA 252.14	32	AA 333.20	41	AA 571.12	50
AA 036.11	4	AA 134.14	23	AA 254.14	32	AA 333.23	41	AA 582.12	50
AA 036.14	4	AA 134.24	10	AA 255.14	32	AA 335.18	41	AA 584.12	50
AA 036.17	4	AA 135.14	23	AA 257.14	32	AA 335.20	41	AA 587.12	50
AA 038.16	4	AA 135.24	10	AA 259.14	32	AA 335.23	41	AA 589.12	50
AA 038.20	4	AA 136.14	23	AA 264.15	32	AA 337.18	41	AA 594.11	50
AA 038.24	4	AA 137.07	10	AA 265.15	32	AA 337.20	41	AA 594.11	50
AA 050.19	5	AA 137.71	10	AA 280.18	33	AA 337.23	41	AA 595.11	50
AA 057.01	5	AA 140.03	10	AA 280.20	33	AA 340.14	42	AA 618.08	50
AA 057.02	5	AA 140.14	23	AA 280.23	33	AA 341.14	42	AA 619.08	50
AA 090.09	6	AA 141.14	23	AA 280.25	33	AA 344.11	42	AA 620.09	51
AA 094.13	6	AA 155.10	11	AA 280.28	33	AA 345.11	42	AA 621.10	51
AA 096.00	6	AA 155.11	11	AA 280.30	33	AA 350.14	42	AA 621.09	51
AA 100.04	7	AA 155.12	11	AA 282.18	33	AA 351.14	42	AA 621.10	51
AA 100.10	16	AA 155.13	11	AA 282.20	33	AA 353.11	43	AA 622.10	51
AA 100.11	16	AA 155.14	11	AA 282.23	33	AA 359.12	43	AA 624.09	51
AA 100.13	16	AA 155.15	11	AA 282.25	33	AA 359.15	43	AA 625.09	51
AA 100.14	16	AA 155.17	11	AA 282.28	33	AA 360.14	43	AA 630.11	51
AA 100.15	16	AA 155.18	12	AA 282.30	33	AA 361.14	43	AA 631.11	51
AA 100.16	16	AA 155.19	12	AA 284.18	34	AA 362.14	43	AA 633.11	51
AA 100.18	16	AA 155.20	12	AA 284.20	34	AA 363.14	43	AA 635.11	51
AA 100.20	16	AA 155.21	12	AA 284.23	34	AA 364.15	43	AA 639.10	51
AA 102.11	17	AA 155.22	12	AA 284.25	34	AA 365.15	43	AA 640.12	51
AA 102.13	17	AA 155.23	12	AA 284.28	34	AA 367.12	43	AA 641.12	51
AA 102.14	17	AA 155.24	12	AA 284.30	34	AA 371.30	44	AA 652.10	52
AA 102.15	17	AA 155.25	12	AA 285.18	35	AA 373.19	44	AA 653.10	52
AA 102.16	17	AA 155.34	12	AA 285.20	35	AA 373.25	44	AA 654.10	52
AA 102.18	17	AA 155.36	12	AA 285.23	35	AA 375.24	44	AA 655.10	52
AA 102.20	17	AA 156.12	11	AA 285.25	35	AA 380.25	45	AA 656.10	52
AA 104.11	18	AA 156.15	11	AA 285.28	35	AA 380.45	45	AA 657.10	52
AA 104.13	18	AA 170.14	24	AA 285.30	35	AA 380.60	45	AA 680.11	52
AA 104.14	18	AA 170.15	24	AA 287.18	35	AA 380.90	45	AA 681.11	52
AA 104.15	18	AA 170.17	24	AA 287.20	35	AA 381.00	45	AA 682.11	52
AA 104.16	18	AA 170.23	24	AA 287.23	35	AA 381.01	45	AA 683.11	52
AA 104.18	18	AA 171.15	24	AA 287.25	35	AA 391.25	45	AA 690.11	52
AA 104.20	18	AA 171.15	24	AA 287.28	35	AA 391.40	45	AA 691.11	52
AA 104.34	7	AA 171.17	24	AA 287.30	35	AA 391.60	45	AA 705.11	52
AA 104.41	7	AA 171.23	24	AA 289.18	36	AA 395.60	45	AA 714.11	52
AA 104.45	7	AA 174.22	25	AA 289.20	36	AA 397.60	45	AA 715.11	52
AA 105.11	19	AA 175.22	25	AA 289.23	36	AA 393.00	45	AA 714.13	52
AA 105.13	19	AA 175.30	25	AA 289.25	36	AA 404.19	44	AA 715.13	52
AA 105.14	19	AA 180.15	26	AA 289.28	36	AA 405.19	44	AA 716.10	53
AA 105.15	19	AA 180.17	26	AA 289.30	36	AA 445.22	46	AA 717.10	53
AA 105.16	19	AA 181.15	26	AA 298.14	37	AA 451.17	46	AA 718.10	53
AA 105.18	19	AA 181.17	26	AA 299.14	37	AA 455.17	46	AA 719.10	53
AA 105.20	19	AA 184.16	27	AA 300.15	37	AA 457.15	46	AA 720.10	53
AA 107.11	20	AA 184.19	27	AA 301.15	37	AA 459.17	46	AA 721.10	53
AA 107.13	20	AA 184.21	27	AA 306.12	38	AA 466.18	46	AA 732.23	54
AA 107.14	20	AA 185.16	27	AA 306.19	38	AA 467.18	46	AA 733.23	54
AA 107.15	20	AA 185.19	27	AA 307.19	38	AA 475.23	46	AA 734.23	54
AA 107.16	20	AA 185.21	27	AA 310.16	39	AA 495.17	47	AA 735.23	54
AA 107.18	20	AA 190.17	28	AA 311.16	39	AA 497.17	47	AA 736.19	54
AA 107.20	20	AA 191.17	28	AA 320.10	39	AA 499.19	47	AA 737.19	54
AA 108.08	8	AA 195.14	28	AA 321.10	39	AA 505.13	47	AA 739.19	54



AA 740.11	54	AA 877.19	62	AA 957.23	82	AB 103.11	101	AB 192.20	96
AA 741.11	54	AA 880.00	13	AA 960.18	83	AB 103.13	101	AB 192.25	96
AA 748.19	54	AA 880.01	13	AA 960.20	83	AB 103.14	101	AB 196.16	96
AA 749.19	54	AA 880.02	13	AA 960.23	83	AB 103.16	101	AB 220.23	96
AA 750.19	55	AA 883.24	62	AA 960.25	83	AB 103.18	101	AB 228.17	97
AA 751.19	55	AA 884.24	62	AA 960.28	83	AB 103.20	101	AB 230.17	97
AA 752.19	55	AA 885.24	63	AA 961.18	83	AB 103.25	101	AB 232.17	97
AA 753.19	55	AA 895.23	63	AA 961.20	83	AB 103.30	101	AB 234.17	97
AA 755.11	55	AA 887.23	63	AA 961.23	83	AB 105.10	94	AB 236.15	97
AA 756.12	55	AA 887.26	63	AA 961.25	83	AB 105.11	94	AB 238.15	97
AA 757.14	55	AA 887.37	63	AA 961.28	83	AB 105.13	94	AB 240.16	97
AA 757.16	55	AA 891.18	64	AA 965.14	84	AB 105.14	94	AB 240.18	97
AA 759.16	55	AA 897.24	64	AA 965.17	84	AB 105.15	94	AB 242.16	97
AA 760.09	55	AA 902.14	75	AA 965.20	84	AB 105.16	94	AB 242.18	97
AA 761.09	55	AA 903.14	75	AA 965.23	84	AB 105.18	94	AB 244.12	98
AA 770.25	56	AA 904.14	75	AA 967.18	85	AB 105.20	94	AB 246.12	98
AA 770.45	56	AA 905.14	75	AA 967.20	85	AB 105.25	94	AB 246.15	98
AA 770.60	56	AA 906.14	75	AA 967.23	85	AB 105.30	94	AB 250.12	98
AA 770.90	56	AA 907.14	75	AA 969.18	85	AB 120.10	93	AB 250.15	98
AA 771.00	56	AA 910.14	76	AA 969.20	85	AB 120.11	93	AB 252.12	98
AA 771.25	56	AA 910.17	76	AA 969.23	85	AB 120.13	93	AB 252.15	98
AA 771.45	56	AA 910.23	76	AA 975.28	86	AB 120.14	93	AB 254.17	98
AA 771.60	56	AA 911.14	76	AA 976.23	86	AB 120.16	93	AB 255.18	98
AA 771.90	56	AA 911.17	76	AA 977.23	86	AB 120.18	93	AB 256.18	98
AA 772.00	56	AA 911.23	76	AA 979.22	86	AB 120.20	93	AB 258.15	99
AA 773.00	57	AA 913.14	77	AA 979.23	86	AB 120.25	93	AB 258.18	99
AA 773.01	57	AA 913.17	77	AA 980.13	87	AB 120.30	93	AB 258.20	99
AA 773.02	57	AA 913.23	77	AA 981.13	87	AB 123.11	101	AB 258.23	99
AA 774.01	57	AA 930.15	78	AA 982.11	87	AB 123.13	101	AB 258.25	99
AA 774.02	57	AA 930.17	78	AA 983.11	87	AB 123.14	101	AB 259.19	99
AA 774.06	57	AA 931.15	78	AA 985.25	87	AB 123.16	101	AB 260.14	99
AA 775.01	57	AA 931.17	78	AA 985.45	87	AB 123.18	101	AB 260.16	99
AA 775.03	57	AA 935.16	78	AA 985.60	87	AB 123.20	101	AB 260.18	99
AA 776.01	58	AA 936.11	78	AA 987.25	87	AB 123.25	101	AB 260.20	99
AA 776.02	58	AA 937.11	78	AA 987.45	87	AB 126.13	94	AB 260.25	99
AA 778.01	58	AA 938.14	78	AA 987.60	87	AB 126.14	94	AB 260.30	99
AA 778.02	58	AA 939.14	78	AA 989.11	88	AB 130.15	94	AB 266.15	100
AA 782.21	59	AA 942.18	79	AA 991.12	88	AB 130.18	94	AB 266.23	100
AA 784.21	59	AA 942.20	79	AA 992.16	88	AB 130.20	94	AB 266.25	100
AA 805.20	61	AA 942.23	79	AA 993.16	88	AB 140.09	94	AB 270.15	100
AA 806.14	61	AA 942.25	79	AA 994.17	88	AB 140.10	94	AB 270.19	100
AA 806.16	61	AA 942.28	79	AA 995.12	88	AB 140.11	94	AB 270.24	100
AA 806.18	61	AA 942.30	79	AA 997.16	88	AB 140.13	94	AB 272.15	100
AA 807.14	61	AA 943.18	79	AA 999.16	88	AB 140.14	94	AB 272.19	100
AA 807.16	61	AA 943.20	79			AB 141.09	94	AB 272.24	100
AA 807.18	61	AA 943.23	79	AB		AB 141.10	94	AB 303.14	102
AA 808.14	61	AA 943.25	79	AB 001.01	90	AB 141.11	94	AB 303.16	102
AA 808.16	61	AA 943.28	79	AB 001.03	90	AB 141.13	94	AB 304.13	102
AA 808.18	61	AA 943.30	79	AB 001.05	90	AB 141.14	94	AB 304.16	102
AA 809.14	61	AA 945.20	80	AB 003.03	90	AB 166.12	95	AB 321.14	102
AA 809.16	61	AA 945.23	80	AB 003.05	90	AB 168.12	95	AB 321.16	102
AA 809.18	61	AA 945.28	80	AB 005.03	90	AB 168.15	95	AB 321.20	102
AA 819.13	60	AA 949.20	80	AB 005.05	90	AB 170.15	95	AB 326.13	102
AA 821.11	60	AA 949.23	80	AB 006.01	91	AB 172.12	95	AB 326.14	102
AA 824.09	60	AA 949.25	80	AB 006.02	91	AB 172.15	95	AB 331.15	103
AA 824.13	60	AA 949.28	80	AB 016.16	91	AB 176.18	95	AB 332.15	103
AA 827.11	60	AA 950.16	81	AB 019.01	92	AB 178.17	95	AB 362.18	103
AA 830.14	60	AA 950.21	81	AB 019.02	92	AB 180.17	95	AB 362.20	103
AA 830.17	60	AA 951.16	81	AB 019.03	92	AB 183.17	95	AB 362.25	103
AA 834.14	60	AA 951.21	81	AB 020.01	92	AB 184.06	96	AB 364.15	103
AA 835.14	61	AA 952.16	81	AB 020.02	92	AB 184.08	96	AB 365.15	103
AA 835.16	61	AA 954.14	82	AB 100.11	93	AB 184.10	96	AB 366.15	103
AA 835.18	61	AA 955.14	82	AB 100.13	93	AB 186.18	96	AB 366.20	103
AA 835.20	61	AA 956.14	82	AB 100.14	93	AB 187.18	96	AB 367.15	103
AA 838.13	60	AA 956.18	82	AB 100.16	93	AB 188.17	96	AB 367.20	103
AA 840.12	60	AA 956.20	82	AB 100.18	93	AB 189.17	96	AB 367.25	103
AA 850.18	61	AA 956.23	82	AB 100.20	93	AB 190.15	96	AB 368.12	104
AA 855.23	62	AA 957.14	82	AB 100.25	93	AB 190.18	96	AB 368.15	104
AA 860.14	62	AA 957.18	82	AB 100.30	93	AB 190.20	96	AB 370.15	104
AA 877.16	62	AA 957.20	82	AB 103.10	101	AB 192.18	96	AB 372.12	104



AB 372.15	104	AB 601.09	109	AC 305.14	117	AC 375.14	122	AC 417.03	127
AB 374.17	104	AB 601.10	109	AC 306.10	117	AC 375.16	122	AC 417.04	127
AB 380.17	104	AB 601.11	109	AC 307.10	117	AC 384.13	122	AC 417.05	127
AB 383.17	104	AB 601.12	109	AC 309.12	117	AC 384.14	122	AC 419.18	127
AB 384.06	104	AB 604.08	109	AC 310.12	117	AC 384.16	122	AC 421.14	127
AB 384.08	104	AB 604.09	109	AC 310.14	117	AC 385.13	122	AC 421.18	127
AB 384.10	104	AB 604.10	109	AC 311.12	117	AC 385.14	122	AC 422.20	127
AB 386.17	105	AB 604.11	109	AC 311.14	117	AC 385.16	122	AC 423.20	127
AB 387.17	105	AB 604.12	109	AC 312.12	117	AC 380.14	123	AC 425.20	127
AB 388.17	105	AB 605.08	109	AC 312.14	117	AC 380.16	123	AC 426.20	127
AB 390.15	105	AB 605.09	109	AC 313.12	117	AC 380.18	123	AC 427.20	127
AB 390.18	105	AB 605.10	109	AC 313.14	117	AC 381.14	123	AC 427.21	128
AB 390.20	105	AB 605.11	109	AC 316.18	118	AC 381.16	123	AC 428.22	128
AB 392.18	105	AB 605.12	109	AC 316.21	118	AC 381.18	123	AC 429.22	128
AB 392.21	105	AB 671.11	112	AC 317.18	118	AC 382.14	123	AC 430.19	128
AB 392.25	105	AB 675.12	112	AC 317.21	118	AC 382.16	123	AC 431.19	128
AB 396.20	105	AB 681.13	112	AC 318.18	118	AC 382.18	123	AC 432.24	128
AB 400.12	106	AB 685.15	112	AC 318.21	118	AC 383.14	123	AC 433.24	128
AB 402.12	106	AB 687.18	112	AC 319.18	118	AC 383.16	123	AC 439.18	128
AB 403.12	106	AB 691.14	112	AC 319.21	118	AC 383.18	123	AC 439.24	128
AB 404.12	106	AB 695.16	112	AC 320.10	118	AC 390.20	124	AC 443.01	129
AB 406.12	106	AB 695.20	112	AC 320.12	118	AC 390.22	124	AC 443.02	129
AB 408.11	106	AB 697.20	112	AC 321.10	118	AC 390.24	124	AC 443.03	129
AB 410.01	107	AB 720.13	111	AC 321.12	118	AC 390.26	124	AC 443.04	129
AB 410.02	107	AB 721.13	111	AC 322.10	118	AC 391.20	124	AC 443.05	129
AB 410.03	107			AC 323.10	118	AC 391.22	124	AC 443.06	129
AB 410.04	107	AC		AC 323.12	118	AC 391.24	124	AC 443.07	129
AB 420.15	107	AC 110.06	114	AC 324.14	119	AC 391.26	124	AC 447.01	129
AB 420.20	107	AC 111.06	114	AC 325.14	119	AC 392.20	124	AC 447.02	129
AB 420.25	107	AC 114.03	114	AC 326.15	119	AC 392.22	124	AC 447.03	129
AB 426.14	107	AC 114.05	114	AC 327.15	119	AC 392.24	124	AC 447.04	129
AB 426.16	107	AC 115.03	114	AC 328.15	119	AC 392.26	124	AC 447.05	129
AB 426.20	107	AC 115.05	114	AC 329.15	119	AC 393.20	124	AC 447.06	129
AB 431.18	108	AC 118.04	114	AC 330.14	119	AC 393.22	124	AC 447.07	129
AB 432.18	108	AC 118.05	114	AC 331.14	119	AC 393.24	124	AC 451.13	130
AB 448.15	108	AC 118.06	114	AC 334.16	119	AC 393.26	124	AC 451.16	130
AB 448.18	108	AC 118.07	114	AC 335.16	119	AC 410.14	125	AC 451.18	130
AB 449.15	108	AC 118.09	114	AC 339.14	119	AC 410.16	125	AC 451.20	130
AB 451.18	108	AC 119.04	114	AC 340.14	120	AC 410.18	125	AC 451.23	130
AB 452.18	108	AC 119.05	114	AC 341.14	120	AC 410.20	125	AC 451.25	130
AB 456.23	108	AC 119.06	114	AC 342.14	120	AC 410.22	125	AC 451.28	130
AB 460.23	108	AC 119.07	114	AC 343.14	120	AC 410.24	125	AC 453.18	130
AB 466.23	108	AC 119.09	114	AC 344.14	120	AC 410.26	125	AC 453.22	130
AB 502.10	109	AC 120.08	115	AC 344.16	120	AC 410.30	125	AC 453.25	130
AB 503.10	109	AC 120.10	115	AC 345.14	120	AC 411.14	126	AC 453.28	130
AB 505.10	109	AC 120.12	115	AC 345.16	120	AC 411.16	126	AC 461.01	131
AB 512.10	109	AC 121.08	115	AC 346.16	120	AC 411.18	126	AC 461.02	131
AB 513.10	109	AC 121.10	115	AC 347.16	120	AC 411.20	126	AC 461.03	131
AB 515.10	109	AC 121.12	115	AC 348.15	120	AC 411.22	126	AC 461.04	131
AB 522.12	110	AC 122.10	115	AC 350.15	120	AC 411.24	126	AC 461.05	131
AB 530.07	110	AC 122.14	115	AC 351.12	120	AC 411.26	126	AC 462.21	131
AB 530.09	110	AC 122.20	115	AC 355.14	120	AC 411.30	126	AC 462.26	131
AB 530.11	110	AC 123.10	115	AC 357.14	120	AC 414.14	125	AC 463.21	131
AB 540.10	110	AC 123.14	115	AC 363.18	121	AC 414.16	125	AC 463.26	131
AB 541.10	110	AC 123.20	115	AC 363.19	121	AC 414.18	125	AC 464.21	131
AB 550.10	110	AC 150.10	116	AC 364.18	121	AC 414.20	125	AC 464.26	131
AB 551.10	110	AC 176.14	116	AC 365.18	121	AC 414.22	125	AC 465.21	131
AB 557.10	110	AC 176.16	116	AC 366.18	121	AC 414.24	125	AC 465.26	131
AB 559.10	110	AC 248.13	116	AC 367.18	121	AC 414.26	125	AC 469.01	132
AB 561.09	110	AC 248.14	116	AC 369.18	121	AC 414.30	125	AC 469.02	132
AB 564.08	110	AC 248.15	116	AC 369.20	121	AC 415.14	126	AC 471.14	132
AB 566.09	111	AC 248.18	116	AC 369.24	121	AC 415.16	126	AC 473.15	132
AB 574.09	111	AC 248.20	116	AC 370.16	121	AC 415.18	126	AC 473.19	132
AB 576.09	111	AC 249.13	116	AC 370.20	121	AC 415.20	126	AC 479.19	133
AB 580.09	111	AC 249.14	116	AC 371.16	121	AC 415.22	126	AC 483.22	133
AB 595.10	111	AC 249.15	116	AC 371.20	121	AC 415.24	126	AC 485.23	133
AB 600.09	109	AC 249.18	116	AC 374.13	122	AC 415.26	126	AC 487.21	133
AB 600.10	109	AC 249.20	116	AC 374.14	122	AC 415.30	126	AC 487.24	133
AB 600.11	109	AC 290.14	117	AC 374.16	122	AC 417.01	127	AC 491.22	134
AB 600.12	109	AC 303.14	117	AC 375.13	122	AC 417.02	127	AC 493.25	134



AC 495.28	134	AC 909.11	144	AD 091.18	156	AD 221.03	161	AD 391.03	168
AC 497.22	134	AC 909.13	144	AD 093.12	156	AD 221.04	161	AD 395.24	168
AC 501.18	134	AC 913.11	144	AD 093.14	156	AD 221.06	161	AD 395.26	168
AC 511.19	134	AC 915.08	144	AD 093.16	156	AD 240.01	161	AD 401.01	169
AC 511.23	134	AC 915.11	144	AD 093.18	156	AD 240.02	161	AD 401.02	169
AC 521.24	134	AC 915.13	144	AD 095.10	157	AD 240.03	161	AD 401.03	169
AC 529.23	135	AC 915.15	144	AD 095.17	157	AD 240.04	161	AD 405.01	170
AC 529.24	135	AC 917.13	144	AD 095.20	157	AD 240.06	161	AD 405.02	170
AC 531.20	135	AC 917.15	144	AD 095.22	157	AD 240.08	161	AD 405.03	170
AC 531.22	135	AC 919.10	145	AD 099.16	157	AD 241.01	161	AD 405.04	170
AC 531.24	135	AC 919.13	145	AD 100.01	157	AD 241.02	161	AD 405.05	170
AC 533.23	135	AC 921.16	145	AD 100.02	157	AD 241.03	161	AD 405.06	170
AC 537.22	136	AC 922.18	145	AD 100.03	157	AD 241.04	161	AD 441.01	171
AC 549.23	136	AC 923.10	145	AD 100.04	157	AD 241.06	161	AD 441.02	171
AC 561.22	137	AC 923.13	145	AD 101.01	157	AD 241.08	161	AD 441.03	171
AC 563.23	137	AC 925.14	145	AD 101.02	157	AD 251.03	162	AD 452.00	171
AC 571.21	137	AC 935.15	145	AD 101.03	157	AD 253.04	162	AD 452.01	171
AC 573.23	137	AC 935.20	145	AD 101.04	157	AD 261.02	162	AD 452.02	171
AC 577.19	138	AC 940.14	146	AD 151.01	157	AD 266.08	162	AD 452.03	171
AC 577.22	138	AC 942.16	146	AD 151.02	157	AD 267.08	162	AD 452.04	171
AC 577.24	138	AC 943.18	146	AD 151.03	157	AD 281.04	163	AD 452.05	171
AC 579.19	138	AC 944.15	146	AD 151.04	157	AD 283.05	163	AD 461.25	172
AC 579.22	138	AC 944.18	146	AD 151.05	157	AD 287.06	163	AD 463.23	172
AC 579.24	138	AC 944.20	146	AD 151.06	157	AD 289.07	163	AD 469.22	172
AC 581.19	138	AC 946.15	146	AD 161.01	158	AD 291.01	164	AD 471.01	172
AC 581.22	138	AC 946.18	146	AD 161.02	158	AD 291.02	164	AD 471.02	172
AC 581.24	138	AC 946.20	146	AD 164.14	158	AD 291.03	164	AD 471.03	172
AC 583.28	139			AD 170.20	158	AD 291.04	164	AD 501.25	173
AC 585.28	139	AD		AD 171.08	158	AD 291.05	164	AD 503.28	173
AC 595.19	139	AD 001.18	154	AD 171.10	158	AD 293.01	164	AD 505.28	173
AC 597.19	139	AD 006.01	154	AD 171.12	158	AD 293.02	164	AD 507.28	173
AC 600.21	140	AD 011.01	154	AD 171.14	158	AD 293.03	164	AD 537.01	174
AC 601.21	140	AD 021.02	154	AD 171.16	158	AD 293.04	164	AD 537.02	174
AC 613.19	140	AD 021.03	154	AD 171.18	158	AD 293.05	164	AD 537.03	174
AC 613.21	140	AD 030.12	154	AD 172.08	159	AD 295.21	164	AD 545.01	174
AC 613.23	140	AD 030.14	154	AD 172.10	159	AD 297.21	164	AD 545.02	174
AC 615.19	140	AD 030.16	154	AD 172.12	159	AD 315.18	165	AD 551.25	175
AC 615.21	140	AD 066.01	155	AD 172.14	159	AD 315.20	165	AD 557.74	175
AC 615.23	140	AD 066.02	155	AD 172.16	159	AD 315.25	165	AD 558.08	176
AC 625.21	140	AD 068.01	155	AD 172.18	159	AD 315.30	165	AD 558.10	176
AC 633.24	140	AD 068.02	155	AD 174.08	159	AD 315.40	165	AD 558.12	176
AC 635.10	141	AD 068.03	155	AD 174.11	159	AD 317.01	165	AD 558.13	176
AC 635.20	141	AD 068.04	155	AD 174.15	159	AD 317.02	165	AD 558.14	176
AC 635.30	141	AD 070.16	155	AD 174.17	159	AD 317.03	165	AD 558.16	176
AC 635.40	141	AD 072.01	155	AD 174.20	159	AD 317.04	165	AD 558.18	176
AC 637.10	141	AD 072.02	155	AD 174.23	159	AD 317.05	165	AD 559.08	177
AC 637.20	141	AD 074.01	155	AD 176.01	160	AD 317.06	165	AD 559.10	177
AC 637.30	141	AD 074.02	155	AD 176.02	160	AD 317.07	165	AD 559.12	177
AC 637.40	141	AD 074.03	155	AD 191.01	160	AD 317.08	165	AD 559.14	177
AC 671.23	142	AD 074.04	155	AD 191.02	160	AD 317.09	165	AD 559.16	177
AC 673.24	142	AD 075.01	155	AD 203.15	160	AD 321.01	166	AD 559.18	177
AC 676.24	142	AD 075.02	155	AD 207.18	160	AD 321.02	166	AD 561.01	178
AC 677.24	142	AD 075.03	155	AD 209.18	160	AD 321.03	166	AD 561.02	178
AC 679.25	142	AD 075.04	155	AD 210.01	160	AD 321.04	166	AD 561.03	178
AC 697.25	142	AD 078.01	156	AD 210.02	160	AD 321.05	166	AD 562.01	178
AC 717.22	142	AD 078.02	156	AD 210.03	160	AD 325.01	167	AD 562.02	178
AC 719.23	142	AD 078.03	156	AD 210.04	160	AD 325.02	167	AD 563.01	178
AC 721.14	143	AD 078.04	156	AD 210.06	160	AD 351.01	167	AD 563.02	178
AC 725.18	143	AD 079.01	156	AD 211.01	160	AD 351.02	167	AD 563.03	178
AC 727.20	143	AD 079.02	156	AD 211.02	160	AD 360.01	167	AD 563.04	178
AC 727.20	143	AD 079.03	156	AD 211.03	160	AD 360.02	167	AD 563.05	178
AC 745.20	143	AD 079.04	156	AD 211.04	160	AD 360.03	167	AD 563.06	178
AC 749.21	143	AD 086.04	156	AD 211.06	160	AD 361.01	167	AD 577.27	179
AC 751.20	143	AD 087.04	156	AD 220.01	161	AD 361.02	167	AD 579.27	179
AC 753.20	143	AD 088.12	156	AD 220.02	161	AD 361.03	167	AD 581.01	180
AC 875.09	144	AD 091.08	156	AD 220.03	161	AD 381.00	168	AD 581.02	180
AC 877.09	144	AD 091.10	156	AD 220.04	161	AD 381.01	168	AD 583.01	180
AC 881.05	144	AD 091.12	156	AD 220.06	161	AD 381.02	168	AD 591.01	181
AC 881.09	144	AD 091.14	156	AD 221.01	161	AD 391.01	168	AD 591.02	181
AC 883.09	144	AD 091.16	156	AD 221.02	161	AD 391.02	168	AD 591.03	181



AD 591.04	181	AD 724.10	192	AD 817.17	203	AD 906.07	215	AE 328.12	222
AD 591.05	181	AD 725.14	192	AD 820.00	203	AD 906.11	215	AE 330.13	222
AD 591.06	181	AD 727.14	192	AD 822.22	203	AD 906.12	215	AE 332.12	222
AD 591.07	183	AD 732.20	192	AD 823.00	204	AD 906.13	215	AE 334.13	222
AD 591.08	183	AD 734.20	192	AD 824.00	204	AD 906.41	215	AE 336.13	222
AD 591.09	183	AD 734.24	192	AD 826.00	204	AD 906.42	215	AE 338.13	222
AD 592.04	183	AD 735.20	192	AD 827.00	205	AD 906.43	215	AE 340.14	222
AD 592.07	183	AD 735.24	192	AD 827.01	205	AD 906.44	215	AE 344.13	222
AD 592.08	183	AD 736.26	193	AD 827.02	205	AD 906.46	215	AE 344.18	222
AD 592.10	183	AD 737.26	193	AD 827.03	205	AD 906.47	215	AE 348.15	223
AD 593.01	183	AD 738.26	193	AD 828.00	205	AD 906.50	215	AE 350.15	223
AD 593.02	183	AD 739.26	193	AD 828.01	205	AD 953.28	216	AE 350.18	223
AD 593.03	183	AD 748.10	193	AD 830.00	205	AD 963.20	216	AE 360.18	223
AD 603.01	184	AD 749.10	193	AD 830.02	205	AD 963.25	216	AE 364.18	223
AD 603.02	184	AD 750.13	193	AD 830.04	205	AD 963.30	216	AE 384.17	223
AD 603.03	184	AD 750.16	193	AD 839.18	206	AD 963.35	216	AE 390.14	223
AD 607.26	184	AD 751.13	193	AD 839.27	206	AD 963.40	216	AE 390.16	223
AD 610.01	184	AD 751.16	193	AD 839.38	206,212	AD 963.45	216	AE 390.18	223
AD 610.02	184	AD 752.13	194	AD 839.40	206	AD 963.50	216	AE 390.20	223
AD 611.01	184	AD 753.13	194	AD 839.45	206,212	AD 971.00	216	AE 390.24	223
AD 611.02	184	AD 754.15	194	AD 839.50	206	AD 971.01	216	AE 390.26	223
AD 615.01	185	AD 755.13	194	AD 839.52	207	AD 971.02	216	AE 390.30	223
AD 615.02	185	AD 756.13	194	AD 839.60	207	AD 975.06	216	AE 392.15	224
AD 615.03	185	AD 757.11	194	AD 839.70	207	AD 975.09	216	AE 392.18	224
AD 617.28	186	AD 759.11	194	AD 839.80	207	AD 975.13	216	AE 392.20	224
AD 621.28	186	AD 765.13	195	AD 839.90	205,207	AD 975.16	216	AE 394.20	224
AD 623.20	186	AD 767.13	195	AD 839.92	205,207	AD 975.19	216	AE 396.16	224
AD 623.30	186	AD 768.00	195	AD 839.94	205,207	AD 975.25	216	AE 396.18	224
AD 623.40	186	AD 768.19	195	AD 840.00	208			AE 396.20	224
AD 625.45	187	AD 768.25	195	AD 842.00	208	AE		AE 403.21	224
AD 625.60	187	AD 768.32	195	AD 844.00	208	AE 048.18	218	AE 404.23	224
AD 626.30	187	AD 769.00	195	AD 846.00	208	AE 049.18	218	AE 408.27	224
AD 626.40	187	AD 770.13	196	AD 850.00	209	AE 050.18	218	AE 415.27	225
AD 626.50	187	AD 770.16	196	AD 852.00	209	AE 051.18	218	AE 420.27	225
AD 626.60	187	AD 770.20	196	AD 854.00	209	AE 264.14	218	AE 437.27	225
AD 626.70	187	AD 770.26	196	AD 856.00	210	AE 274.14	218	AE 451.23	226
AD 651.01	188	AD 771.13	196	AD 858.00	210	AE 286.10	218	AE 466.14	226
AD 651.02	188	AD 771.16	196	AD 858.01	210	AE 287.10	218	AE 469.16	226
AD 655.00	188	AD 771.20	196	AD 859.01	210	AE 288.10	218	AE 500.15	226
AD 655.01	188	AD 771.26	196	AD 859.02	210	AE 289.10	218	AE 516.14	226
AD 655.02	188	AD 774.40	197	AD 859.05	211	AE 290.14	218	AE 516.17	226
AD 655.03	188	AD 774.45	197	AD 859.06	211	AE 291.14	218	AE 516.20	226
AD 663.00	188	AD 774.50	197	AD 860.00	211	AE 300.11	219	AE 526.14	227
AD 665.00	188	AD 774.55	197	AD 866.00	211	AE 300.13	219	AE 526.17	227
AD 667.00	189	AD 774.60	197	AD 868.00	211	AE 300.14	219	AE 530.12	227
AD 667.06	189	AD 775.40	197	AD 882.00	212	AE 302.09	219	AE 574.18	227
AD 668.16	158	AD 775.45	197	AD 882.30	212	AE 302.13	220	AE 576.20	227
AD 669.13	189	AD 775.50	197	AD 883.00	212	AE 303.09	219	AE 600.18	231
AD 669.16	158	AD 775.55	197	AD 883.01	212	AE 303.13	220	AE 602.18	231
AD 673.01	189	AD 775.60	197	AD 883.02	212	AE 304.09	219	AE 604.13	231
AD 673.02	189	AD 776.31	198	AD 884.24	213	AE 304.13	220	AE 604.15	231
AD 675.00	189	AD 777.32	198	AD 889.40	213	AE 305.09	219	AE 618.16	231
AD 683.00	190	AD 778.00	199	AD 889.50	212,213	AE 305.13	220	AE 618.18	231
AD 687.00	190	AD 778.01	199	AD 889.60	212	AE 306.14	220	AE 618.20	231
AD 695.00	190	AD 778.02	199	AD 889.80	212	AE 307.14	220	AE 618.23	231
AD 700.05	191	AD 778.03	199	AD 889.98	212	AE 308.14	220	AE 618.26	231
AD 701.05	191	AD 778.32	199	AD 889.99	212	AE 309.14	220	AE 620.14	231
AD 702.07	191	AD 790.01	200	AD 898.00	213	AE 310.14	220	AE 620.18	231
AD 703.07	191	AD 790.02	200	AD 898.05	213	AE 311.14	220	AE 620.21	231
AD 704.07	191	AD 792.00	201	AD 898.07	213	AE 312.14	220	AE 621.14	231
AD 705.07	191	AD 792.01	201	AD 898.12	213	AE 313.14	220	AE 621.18	231
AD 708.04	191	AD 792.02	201	AD 900.00	214	AE 314.16	221	AE 621.21	231
AD 714.07	191	AD 793.00	201	AD 900.01	214	AE 315.16	221	AE 622.14	232
AD 714.10	191	AD 794.00	201	AD 900.09	214	AE 316.13	221	AE 622.16	232
AD 715.07	191	AD 798.01	201	AD 900.15	214	AE 317.12	221	AE 623.16	232
AD 715.10	191	AD 801.18	202	AD 902.00	214	AE 319.16	221	AE 624.13	232
AD 717.10	191	AD 802.13	202	AD 906.00	215	AE 320.23	221	AE 626.13	232
AD 720.10	191	AD 802.18	202	AD 906.01	215	AE 321.23	221	AE 628.13	232
AD 721.10	191	AD 804.18	202	AD 906.02	215	AE 323.19	221	AE 630.13	233
AD 723.10	191	AD 810.15	202	AD 906.06	215	AE 326.12	222	AE 631.13	233



AE 632.12	233	AE 668.04	238	AE 863.30	247	AF 212.23	257	AQ 185.21	266
AE 634.13	233	AE 668.05	238	AE 864.30	247	AF 256.13	257	AQ 186.16	262
AE 634.14	233	AE 672.14	238	AE 865.25	247	AF 258.13	257	AQ 187.16	262
AE 635.13	233	AE 672.17	238	AE 866.28	247	AF 268.14	257	AQ 189.16	262
AE 636.13	233	AE 672.18	238	AE 867.25	247	AF 280.15	257	AQ 190.20	266
AE 637.12	233	AE 673.15	238	AE 868.18	248	AF 280.20	257	AQ 191.16	262
AE 637.13	233	AE 673.16	238	AE 868.27	248	AF 286.20	257	AQ 194.20	266
AE 638.15	234	AE 674.14	239	AE 869.27	248	AF 287.20	257	AQ 205.17	267
AE 638.18	234	AE 674.17	239	AE 870.01	248	AF 536.16	258	AQ 210.19	267
AE 638.20	234	AE 674.20	239	AE 870.19	248	AF 536.20	258	AQ 215.09	267
AE 638.22	234	AE 676.14	239	AE 870.24	248	AF 536.25	258	AQ 242.18	267
AE 639.18	234	AE 676.17	239	AE 871.19	248	AF 536.30	258	AQ 248.15	267
AE 639.20	234	AE 676.20	239	AE 872.19	248	AF 540.18	258	AQ 250.00	263
AE 639.23	234	AE 678.17	239	AE 875.03	249	AF 540.20	258	AQ 250.02	263
AE 640.18	234	AE 678.20	239	AE 875.05	249	AF 540.23	258	AQ 250.03	263
AE 640.20	234	AE 678.23	239	AE 875.07	249	AF 566.25	258	AQ 250.06	263
AE 640.26	234	AE 679.17	239	AE 877.22	249	AF 566.26	258	AQ 250.09	263
AE 642.16	234	AE 679.19	239	AE 878.22	249	AF 618.26	259	AQ 250.12	263
AE 642.18	234	AE 684.18	240	AE 882.23	249	AF 622.25	259	AQ 250.15	263
AE 642.20	234	AE 686.20	240	AE 886.23	249	AF 702.24	259	AQ 250.80	263
AE 642.24	234	AE 692.18	240	AE 894.14	250	AF 704.24	259	AQ 250.90	263
AE 642.26	234	AE 692.20	240	AE 901.10	250	AF 706.24	259	AQ 251.02	264
AE 642.30	234	AE 692.23	240	AE 904.12	250			AQ 251.03	264
AE 643.20	235	AE 696.20	240	AE 910.18	250	AQ		AQ 251.04	264
AE 643.24	235	AE 696.23	240	AE 916.12	250	AQ 100.11	262	AQ 251.06	264
AE 643.26	235	AE 701.15	241	AE 918.12	250	AQ 100.13	262	AQ 251.07	264
AE 646.18	235	AE 702.15	241	AE 922.12	250	AQ 100.14	262	AQ 251.08	264
AE 646.20	235	AE 703.15	241	AE 928.12	250	AQ 100.16	262	AQ 251.10	264
AE 646.23	235	AE 704.15	241	AE 929.12	250	AQ 100.18	262	AQ 251.12	264
AE 646.26	235	AE 721.19	241	AE 934.13	250	AQ 100.20	262	AQ 251.14	264
AE 646.31	235	AE 722.19	241	AE 935.14	250	AQ 100.25	262	AQ 251.30	264
AE 646.37	235	AE 723.19	241	AE 940.01	251	AQ 102.11	262	AQ 253.04	264
AE 648.27	235	AE 724.19	241	AE 940.02	251	AQ 102.13	262	AQ 253.05	264
AE 650.13	235	AE 741.23	242	AE 940.04	251	AQ 102.14	262	AQ 253.06	264
AE 650.15	235	AE 742.23	242	AE 940.05	251	AQ 102.16	262	AQ 253.07	264
AE 650.18	235	AE 743.23	242	AE 940.06	251	AQ 102.18	262	AQ 253.08	264
AE 650.20	235	AE 744.23	242	AE 940.07	251	AQ 102.20	262	AQ 253.09	264
AE 650.23	235	AE 775.01	242	AE 940.08	251	AQ 102.25	262	AQ 253.10	264
AE 650.26	235	AE 775.02	242	AE 940.09	251	AQ 104.11	262	AQ 260.00	268
AE 652.15	236	AE 775.03	242	AE 952.00	251	AQ 104.13	262	AQ 262.00	268
AE 652.17	236	AE 775.21	242			AQ 104.14	262	AQ 265.00	268
AE 652.20	236	AE 775.25	242	AF		AQ 104.16	262	AQ 281.00	268
AE 653.27	236	AE 813.32	243	AF 010.20	254	AQ 104.18	262	AQ 408.01	269
AE 654.13	236	AE 815.21	243	AF 012.20	254	AQ 104.20	262	AQ 409.01	269
AE 654.15	236	AE 825.20	243	AF 026.14	254	AQ 108.11	262	AQ 410.01	269
AE 654.18	236	AE 832.19	243	AF 130.12	254	AQ 108.13	262	AQ 410.02	269
AE 654.20	236	AE 835.13	243	AF 132.15	254	AQ 108.14	262	AQ 410.12	264
AE 654.23	236	AE 837.13	243	AF 134.15	254	AQ 108.16	262	AQ 410.14	264
AE 654.26	236	AE 839.24	244	AF 134.19	254	AQ 108.18	262	AQ 410.16	264
AE 656.27	236	AE 840.24	244	AF 134.25	254	AQ 108.20	262	AQ 412.01	269
AE 658.14	237	AE 841.20	244	AF 138.15	254	AQ 108.25	262	AQ 414.01	269
AE 658.18	237	AE 842.20	244	AF 142.15	254	AQ 130.10	262	AQ 415.21	270
AE 658.20	237	AE 843.20	244	AF 148.15	254	AQ 150.14	262	AQ 416.01	270
AE 658.23	237	AE 844.20	244	AF 148.19	254	AQ 150.16	262	AQ 416.02	270
AE 659.20	237	AE 845.21	245	AF 150.20	255	AQ 150.23	266	AQ 418.15	270
AE 659.24	237	AE 846.21	245	AF 154.20	255	AQ 155.18	266	AQ 418.20	270
AE 659.26	237	AE 847.21	245	AF 170.20	255	AQ 156.18	266	AQ 418.30	270
AE 659.28	237	AE 848.21	245	AF 186.16	255	AQ 160.11	262	AQ 418.50	270
AE 662.20	237	AE 849.27	245	AF 190.16	256	AQ 160.13	262	AQ 419.50	270
AE 662.24	237	AE 850.27	245	AF 190.20	256	AQ 160.14	262	AQ 420.12	264
AE 665.22	237	AE 851.27	245	AF 192.16	256	AQ 160.16	262	AQ 420.14	264
AE 665.23	237	AE 852.27	245	AF 192.18	256	AQ 160.18	262	AQ 420.16	264
AE 666.00	238	AE 853.28	246	AF 192.20	256	AQ 160.20	262	AQ 422.15	270
AE 666.02	238	AE 854.28	246	AF 192.24	256	AQ 170.13	262	AQ 425.15	270
AE 666.03	238	AE 855.20	246	AF 196.16	256	AQ 170.14	262	AQ 427.15	270
AE 666.04	238	AE 856.20	246	AF 196.20	256	AQ 170.16	262	AQ 960.00	271
AE 666.05	238	AE 857.20	246	AF 206.20	256	AQ 170.18	262	AQ 966.00	271
AE 668.00	238	AE 858.20	246	AF 210.18	257	AQ 175.14	262	AQ 970.00	271
AE 668.02	238	AE 861.30	247	AF 210.20	257	AQ 184.20	266	AQ 976.00	271
AE 668.03	238	AE 862.30	247	AF 212.20	257	AQ 185.16	262	AQ 980.00	271



CC 426.03	311	CC 472.15	321	CD 165.03	329	CV 492.90	337	GF 177.38	366
CC 426.04	311	CC 472.16	321	CD 166.01	329	CV 494.05	337	GF 195.41	366
CC 427.23	311	CC 472.17	321	CD 166.02	329	CV 494.10	337	GF 300.21	367
CC 427.25	311	CC 473.17	320	CD 166.03	329	CV 494.15	337	GF 328.27	367
CC 429.25	312	CC 474.17	320	CD 167.00	330	CV 494.20	337	GF 329.27	367
CC 430.21	312	CC 476.17	320	CD 168.00	330	CV 494.25	337	GF 344.01	367
CC 430.22	312	CC 477.16	321	CD 169.00	330	CV 494.30	337	GF 344.02	367
CC 431.17	312	CC 477.17	321	CD 170.00	331	CV 494.35	337	GF 344.03	367
CC 432.18	313	CC 478.16	322	CD 170.01	331	CV 494.40	337	GF 345.01	367
CC 432.20	313	CC 478.17	322	CD 170.02	331	CV 494.45	337	GF 345.02	367
CC 432.23	313	CC 478.18	322	CD 170.03	331	CV 494.50	337	GF 345.03	367
CC 432.25	313	CC 479.17	322	CD 170.04	331	CV 494.70	337	GF 614.17	341
CC 433.23	313	CC 527.01	322	CD 171.00	331	CV 494.90	337	GF 616.18	341
CC 433.24	313	CC 527.02	322	CD 171.01	331	CV 495.10	337	GF 628.25	341
CC 433.25	313	CC 559.15	323	CD 171.02	331	CV 495.15	337	GF 645.28	341
CC 434.21	314	CC 561.16	323	CD 171.03	331	CV 495.20	337	GF 659.26	341
CC 434.23	314	CC 563.16	323	CD 171.04	331	CV 495.25	337	GF 663.24	342
CC 434.27	314	CC 570.01	324	CD 171.05	331	CV 495.30	337	GF 682.24	342
CC 434.31	314	CC 570.02	324	CD 171.06	331	CV 495.35	337	GF 683.24	342
CC 435.21	314	CC 570.03	324	CD 174.00	332	CV 495.40	337	GF 697.23	342
CC 435.23	314	CC 570.04	324	CD 175.00	332	CV 495.45	337	GF 699.26	342
CC 435.27	314	CC 570.05	324	CD 177.00	333	CV 495.50	337	GF 728.21	343
CC 435.31	314	CC 570.06	324	CD 178.01	333	CV 496.10	337	GF 734.26	343
CC 436.18	315	CC 570.07	324	CD 178.02	333	CV 496.15	337	GF 738.16	343
CC 436.19	315	CC 570.08	324	CD 178.03	333	CV 496.20	337	GF 740.21	343
CC 436.23	315	CC 570.09	324	CD 191.00	333	CV 496.25	337	GF 741.32	344
CC 436.27	315	CC 571.01	324	CD 191.01	333	CV 496.30	337	GF 744.27	344
CC 437.20	315	CC 571.02	324	CD 191.65	333	CV 496.35	337	GF 756.20	344
CC 437.21	315	CC 571.03	324	CD 191.75	333	CV 496.40	337	GF 773.27	344
CC 437.25	315	CC 571.04	324	CD 218.19	334	CV 496.45	337	GF 779.23	344
CC 437.29	315	CC 571.05	324	CD 220.14	334	CV 496.50	337	GF 793.25	344
CC 438.12	316	CC 571.06	324	CD 224.16	334	CV 550.15	338	GF 841.23	345
CC 438.14	316	CC 571.07	324	CD 226.16	334	CV 550.20	338	GF 843.21	345
CC 438.16	316	CC 571.08	324	CD 231.30	334	CV 550.25	338	GF 846.21	345
CC 438.18	316	CC 571.09	324	CD 231.32	334	CV 550.30	338	GF 846.28	345
CC 438.20	316	CC 573.01	324	CD 233.26	334	CV 556.33	338	GF 851.22	345
CC 439.12	316	CC 573.02	324	CD 535.18	335	CV 558.33	338	GF 851.24	345
CC 439.14	316	CC 573.03	324	CD 535.21	335			GF 853.26	345
CC 439.16	316	CC 573.04	324	CD 537.14	335	CY		GF 855.24	345
CC 439.18	316	CC 573.05	324	CD 537.24	335	CY 691.15	338	GF 855.25	345
CC 439.20	316	CC 573.06	324	CD 539.01	335	CY 691.20	338	GF 857.28	346
CC 440.17	317	CC 573.07	324	CD 539.02	335	CY 691.25	338	GF 859.32	346
CC 441.16	317	CC 573.08	324	CD 539.03	335	CY 691.30	338	GF 861.01	346
CC 443.15	317	CC 573.09	324	CD 539.04	335	CY 691.40	338	GF 861.02	346
CC 445.15	317	CC 588.16	325			CY 695.03	338	GF 863.20	346
CC 447.17	317	CC 589.16	325	CM		CY 695.04	338	GF 865.00	346
CC 449.17	317	CC 590.16	325	CM 151.24	291	CY 695.05	338	GF 865.01	346
CC 451.17	317	CC 591.15	325			CY 695.06	338		
CC 453.16	318	CC 592.16	325	CV		CY 696.06	338	GK	
CC 455.17	318	CC 593.01	326	CV 482.00	336			GK 309.28	368
CC 456.16	318	CC 593.02	326	CV 484.00	336	GA		GK 382.01	368
CC 456.17	318	CC 593.03	326	CV 490.05	337	GA 762.27	340	GK 382.02	368
CC 456.18	318	CC 595.01	326	CV 490.10	337	GA 801.23	340	GK 382.03	368
CC 457.17	318	CC 595.02	326	CV 490.15	337			GK 386.30	368
CC 458.10	319	CC 595.03	326	CV 490.20	337	GC		GK 392.02	368
CC 458.11	319	CC 595.04	326	CV 490.25	337	GC 402.25	366	GK 821.24	347
CC 458.12	319			CV 490.30	337	GC 461.08	366	GK 825.23	347
CC 459.12	319	CD		CV 490.40	337	GC 465.09	366	GK 827.30	347
CC 459.13	319	CD 160.01	327	CV 490.50	337			GK 829.27	347
CC 466.01	320	CD 160.02	327	CV 492.05	337	GD		GK 900.01	348
CC 466.02	320	CD 160.03	327	CV 492.10	337	GD 806.22	340	GK 900.02	348
CC 466.03	320	CD 160.04	327	CV 492.15	337	GD 808.22	340	GK 900.03	348
CC 466.04	320	CD 161.01	328	CV 492.20	337			GK 900.04	348
CC 466.05	320	CD 161.02	328	CV 492.25	337	GF		GK 900.05	348
CC 467.21	320	CD 163.01	328	CV 492.30	337	GF 141.36	366	GK 900.06	348
CC 468.17	320	CD 163.02	328	CV 492.35	337	GF 141.40	366	GK 906.01	348
CC 469.20	321	CD 163.03	328	CV 492.40	337	GF 145.30	366	GK 906.02	348
CC 469.26	321	CD 164.00	329	CV 492.45	337	GF 149.36	366	GK 906.03	348
CC 470.17	321	CD 165.01	329	CV 492.50	337	GF 155.36	366	GK 906.04	348
CC 471.16	321	CD 165.02	329	CV 492.70	337	GF 177.32	366	GK 906.05	348



GK 906.06	348	GK 989.10	350	GU 191.02	354	GU 302.02	357	GV 401.02	360
GK 908.01	348	GK 989.12	350	GU 195.01	354	GU 302.03	357	GV 401.03	360
GK 908.02	348	GK 989.14	350	GU 195.02	354	GU 302.04	357	GV 401.04	360
GK 908.03	348	GK 989.50	350	GU 196.01	354	GU 302.05	357	GV 401.05	360
GK 908.04	348			GU 196.02	354	GU 302.10	357	GV 401.06	360
GK 908.05	348	GO		GU 196.03	354	GU 302.12	357	GV 401.07	360
GK 916.01	348	GO 757.17	340	GU 197.01	354	GU 302.14	357	GV 401.08	360
GK 916.02	348	GO 759.14	340	GU 197.02	354	GU 310.22	357	GV 401.09	360
GK 916.03	348			GU 197.03	354	GU 314.24	357	GV 401.10	360
GK 920.05	349	GQ		GU 199.01	354	GU 323.20	358	GV 401.11	360
GK 920.06	349	GQ 583.32	350	GU 199.02	354	GU 323.25	358	GV 401.12	360
GK 920.07	349	GQ 584.32	350	GU 199.03	354	GU 323.30	358	GV 401.13	360
GK 920.08	349	GQ 585.32	350	GU 202.01	355	GU 323.35	358	GV 401.14	360
GK 920.09	349	GQ 586.32	350	GU 202.02	355	GU 323.40	358	GV 401.15	360
GK 920.11	349	GQ 591.28	350	GU 202.03	355	GU 324.20	358	GV 401.16	360
GK 920.12	349	GQ 593.25	350	GU 203.01	355	GU 324.25	358	GV 401.17	360
GK 920.14	349	GQ 595.26	350	GU 203.02	355	GU 324.30	358	GV 401.18	360
GK 920.15	349			GU 203.03	355	GU 324.35	358	GV 401.19	360
GK 920.16	349	GU		GU 205.01	355	GU 324.40	358	GV 430.02	361
GK 920.19	349	GU 110.01	351	GU 205.02	355	GU 325.20	358	GV 430.04	361
GK 920.20	349	GU 110.02	351	GU 205.03	355	GU 325.25	358	GV 430.06	361
GK 920.21	349	GU 110.03	351	GU 232.01	355	GU 325.30	358	GV 430.08	361
GK 920.23	349	GU 112.01	351	GU 232.02	355	GU 325.35	358	GV 430.10	361
GK 921.05	349	GU 114.01	351	GU 233.01	355	GU 325.40	358	GV 430.12	361
GK 921.06	349	GU 114.02	351	GU 233.02	355	GU 326.01	358	GV 430.14	361
GK 921.07	349	GU 114.03	351	GU 235.01	355	GU 326.02	358	GV 430.16	361
GK 921.08	349	GU 116.01	351	GU 235.02	355	GU 342.01	359	GV 430.18	361
GK 921.09	349	GU 116.02	351	GU 236.01	355	GU 342.02	359	GV 430.20	361
GK 921.11	349	GU 116.03	351	GU 237.01	355	GU 342.03	359	GV 430.22	361
GK 921.12	349	GU 120.01	351	GU 242.01	356	GU 351.00	359	GV 430.24	361
GK 921.14	349	GU 120.02	351	GU 242.02	356	GU 381.24	359	GV 430.26	361
GK 921.15	349	GU 120.03	351	GU 243.01	356	GU 383.24	359	GV 430.82	361
GK 921.16	349	GU 122.01	351	GU 243.02	356			GV 430.84	361
GK 921.19	349	GU 122.02	351	GU 245.01	356	GV		GV 430.94	361
GK 921.20	349	GU 122.03	351	GU 245.02	356	GV 103.34	369	GV 460.10	362
GK 921.21	349	GU 126.01	352	GU 249.01	356	GV 107.35	369	GV 460.12	362
GK 921.23	349	GU 126.02	352	GU 249.02	356	GV 115.33	369	GV 460.14	362
GK 926.05	349	GU 126.03	352	GU 249.03	356	GV 400.01	360	GV 460.16	362
GK 926.06	349	GU 128.01	352	GU 249.04	356	GV 400.02	360	GV 460.18	362
GK 926.07	349	GU 128.02	352	GU 249.05	356	GV 400.03	360	GV 460.20	362
GK 926.08	349	GU 128.03	352	GU 249.06	356	GV 400.04	360	GV 460.82	362
GK 926.09	349	GU 130.01	352	GU 250.01	356	GV 400.05	360	GV 995.00	363
GK 926.11	349	GU 130.02	352	GU 250.02	356	GV 400.06	360	GV 995.01	363
GK 926.12	349	GU 130.03	352	GU 250.03	356	GV 400.07	360		
GK 926.14	349	GU 132.01	352	GU 250.04	356	GV 400.08	360	HA	
GK 926.15	349	GU 132.02	352	GU 250.05	356	GV 400.09	360	HA 180.15	65
GK 926.16	349	GU 132.03	352	GU 250.06	356	GV 400.10	360	HA 181.15	65
GK 926.19	349	GU 134.01	352	GU 251.01	356	GV 400.11	360	HA 180.17	65
GK 926.20	349	GU 134.02	352	GU 251.02	356	GV 400.12	360	HA 181.17	65
GK 926.21	349	GU 160.01	353	GU 251.03	356	GV 400.13	360	HA 102S14	66
GK 926.23	349	GU 160.02	353	GU 251.04	356	GV 400.14	360	HA 107S14	66
GK 927.05	349	GU 160.03	353	GU 251.05	356	GV 400.15	360	HA 170S14	66
GK 927.06	349	GU 164.01	353	GU 251.06	356	GV 400.16	360	HA 170S17	66
GK 927.07	349	GU 164.02	353	GU 260.01	356	GV 400.17	360	HA 170S23	66
GK 927.08	349	GU 164.03	353	GU 260.02	356	GV 400.18	360	HA 171S14	66
GK 927.09	349	GU 166.01	353	GU 260.03	356	GV 400.19	360	HA 171S17	66
GK 927.11	349	GU 166.02	353	GU 260.04	356	GV 400.20	360	HA 171S23	66
GK 927.12	349	GU 166.03	353	GU 261.01	356	GV 400.21	360	HA 180S15	66
GK 927.14	349	GU 182.01	353	GU 261.02	356	GV 400.22	360	HA 180S17	66
GK 927.15	349	GU 182.02	353	GU 261.03	356	GV 400.23	360	HA 181S15	66
GK 927.16	349	GU 182.03	353	GU 261.04	356	GV 400.24	360	HA 181S17	66
GK 927.19	349	GU 183.01	353	GU 262.01	356	GV 400.25	360	HA 200S20	67
GK 927.20	349	GU 183.02	353	GU 262.02	356	GV 400.26	360	HA 203S20	67
GK 927.21	349	GU 183.03	353	GU 262.03	356	GV 400.27	360	HA 203S23	67
GK 927.23	349	GU 185.01	353	GU 262.04	356	GV 400.28	360	HA 215S24	67
GK 964.27	350	GU 185.02	353	GU 280.01	357	GV 400.29	360	HA 248S11	67
GK 989.03	350	GU 185.03	353	GU 280.02	357	GV 400.30	360	HA 249S11	67
GK 989.04	350	GU 190.01	354	GU 280.03	357	GV 400.84	360	HA 250S14	67
GK 989.06	350	GU 190.02	354	GU 302.00	357	GV 400.94	360	HA 251S14	67
GK 989.08	350	GU 191.01	354	GU 302.01	357	GV 401.01	360	HA 280S14	68



HA 280S18	68	KC 676.19	373	KH 700.20	381	KH 815.16	389	KI 500.15	397
HA 280S20	68	KC 676.24	373	KH 701.20	381	KH 819.19	389	KI 500.20	397
HA 280S23	68	KC 678.00	373	KH 705.23	381	KH 826.18	389	KI 502.16	397
HA 281S14	68	KC 678.01	373	KH 710.20	382	KH 827.18	389	KI 502.17	397
HA 281S18	68	KC 679.11	373	KH 711.20	382	KH 829.18	389	KI 505.17	398
HA 281S20	68	KC 680.13	374	KH 713.20	382	KH 832.19	389	KI 506.18	397
HA 281S23	68	KC 681.20	374	KH 714.14	382	KH 833.19	389	KI 506.20	397
HA 310S16	68	KC 682.15	374	KH 715.19	382	KH 835.15	390	KI 507.18	398
HA 311S16	68	KC 683.15	374	KH 716.19	382	KH 837.15	390	KI 508.22	398
HA 331S18	68			KH 717.12	382	KH 839.15	390	KI 510.15	398
HA 331S23	68	KD		KH 718.17	383	KH 846.17	390	KI 510.18	399
HA 364S15	68	KD 484.17	375	KH 719.16	383	KH 847.17	390	KI 511.01	399
HA 365S13	68	KD 485.17	375	KH 719.24	383	KH 853.15	390	KI 511.02	399
HA 365S15	68	KD 486.17	375	KH 720.14	383	KH 864.15	390	KI 511.03	399
HA 391S25	69	KD 487.17	375	KH 721.14	383	KH 865.15	390	KI 512.18	399
HA 391S40	69	KD 495.20	375	KH 721.17	383	KH 867.20	390	KI 514.18	399
HA 391S60	69	KD 497.20	375	KH 721.20	383	KH 871.20	390	KI 516.18	399
HA 440S11	69	KD 499.01	375	KH 722.21	384	KH 876.15	391	KI 518.16	399
HA 441S11	69	KD 499.02	375	KH 723.18	384	KH 877.15	391	KI 519.01	399
HA 505S13	70	KD 499.03	375	KH 724.21	384	KH 879.18	391	KI 519.02	399
HA 507S13	70	KD 499.04	375	KH 726.18	384	KH 881.18	391	KI 519.03	399
HA 508S13	70	KD 506.17	376	KH 727.20	384	KH 883.17	391	KI 520.16	400
HA 509S16	70	KD 508.17	376	KH 728.17	385	KH 885.20	391	KI 522.16	400
HA 511S18	70	KD 510.17	376	KH 728.21	385	KH 887.18	391	KI 523.16	400
HA 531S18	70	KD 513.16	376	KH 730.17	385	KH 893.23	391	KI 523.22	400
HA 535S14	70	KD 514.17	376	KH 730.21	385	KH 895.22	392	KI 524.15	400
HA 535S22	70	KD 518.16	376	KH 731.19	385	KH 897.23	392	KI 526.18	400
HA 570S12	71	KD 519.06	376	KH 732.23	385	KH 899.02	392		
HA 571S12	71	KD 519.12	376	KH 732.26	385	KH 899.03	392	KK	
HA 592S11	71	KD 519.19	376	KH 734.26	385	KH 899.04	392	KK 280.01	401
HA 593S11	71	KD 519.25	376	KH 740.22	385	KH 901.23	392	KK 280.02	401
HA 630S11	71	KD 523.16	376	KH 740.27	385	KH 905.24	392	KK 280.03	401
HA 631S11	71	KD 525.21	377	KH 740.30	385	KH 907.24	392	KK 280.04	401
HA 640S12	71	KD 527.19	377	KH 742.22	385	KH 909.24	393	KK 280.05	401
HA 641S12	71	KD 529.13	377	KH 742.27	385	KH 910.22	393	KK 280.06	401
HA 660S23	72	KD 529.18	377	KH 742.30	385	KH 911.22	393	KK 280.10	401
HA 661S23	72	KD 537.05	377	KH 745.19	385	KH 912.23	393	KK 280.20	401
HA 663S18	72	KD 537.07	377	KH 745.23	385	KH 912.27	393	KK 280.30	401
HA 665S17	72	KD 539.06	377	KH 745.26	385	KH 913.23	393	KK 280.40	401
HA 670S18	72	KD 539.08	377	KH 746.23	386	KH 913.27	393	KK 282.01	401
HA 671S18	72	KD 539.15	377	KH 746.25	386	KH 916.30	393	KK 282.02	401
HA 672S19	72	KD 539.16	377	KH 746.28	386	KH 918.30	393	KK 282.03	401
HA 673S19	72	KD 541.08	378	KH 747.23	386	KH 928.20	394	KK 282.04	401
HA 675S15	73	KD 541.18	378	KH 747.25	386	KH 930.19	394	KK 282.10	401
HA 675S19	73	KD 541.43	378	KH 747.28	386	KH 934.14	394	KK 300.10	402
HA 676S11	73	KD 541.70	378	KH 749.15	386	KH 934.17	394	KK 300.20	402
HA 676S14	73	KD 543.43	379	KH 749.19	386	KH 934.19	394	KK 300.30	402
HA 677S16	73	KD 545.22	379	KH 749.24	386	KH 934.22	394	KK 301.01	402
HA 678S19	73	KD 545.33	379	KH 749.26	386	KH 935.14	394	KK 301.02	402
HA 679S19	73	KD 547.24	379	KH 749.28	386	KH 935.17	394	KK 301.03	402
HA 835S14	73	KD 549.22	379	KH 750.33	386	KH 935.19	394	KK 301.04	402
HA 835S18	73	KD 559.24	380	KH 750.45	386	KH 935.22	394	KK 304.10	402
HA 835S20	73	KD 561.24	380	KH 752.33	386	KH 939.17	394	KK 304.20	402
		KD 563.26	380	KH 752.45	386	KH 941.15	394	KK 304.30	402
		KD 565.26	380	KH 755.01	387	KH 944.15	395	KK 304.40	402
KA		KD 567.17	380	KH 755.02	387	KH 946.15	395	KK 305.01	402
KA 611.19	372	KD 569.01	380	KH 755.03	387	KH 950.18	395	KK 305.02	402
KA 613.19	372	KD 569.02	380	KH 757.17	387	KH 951.18	395	KK 305.03	402
KA 630.17	372	KD 569.03	380	KH 771.01	388	KH 952.27	395	KK 305.04	402
KA 631.17	372	KD 569.04	380	KH 771.02	388	KH 954.27	395	KK 305.05	402
KA 633.17	372	KD 569.05	380	KH 773.01	388	KH 955.23	395	KK 305.06	402
KA 641.18	372	KD 571.16	380	KH 773.02	388	KH 955.27	395	KK 308.10	402
KA 643.22	372	KD 573.16	380	KH 775.19	388	KH 957.27	396	KK 308.20	402
KA 645.22	372	KD 762.30	381	KH 777.01	388	KH 959.24	396	KK 308.30	402
KA 650.22	372			KH 777.02	388			KK 309.01	402
KA 651.22	372			KH 799.12	388	KI		KK 309.02	402
KC		KH 387.12	381	KH 801.14	388	KI 500.01	397	KK 309.03	402
KC 139.15	423	KH 387.18	381	KH 803.14	388	KI 500.02	397	KK 309.04	402
KC 674.16	373	KH 387.20	381	KH 805.14	389	KI 500.11	397	KK 309.05	402
KC 676.15	373	KH 387.22	381	KH 807.17	389	KI 500.12	397	KK 309.06	402



KK 312.10	402	KK 345.04	405	KM 110.05	408	KM 132.08	412	KM 157.14	415
KK 312.20	402	KK 345.05	405	KM 110.06	408	KM 132.10	412	KM 157.19	415
KK 312.30	402	KK 345.06	405	KM 118.04	408	KM 132.12	412	KM 157.25	415
KK 313.01	402	KK 347.01	405	KM 118.06	408	KM 133.04	412	KM 157.32	415
KK 313.02	402	KK 347.02	405	KM 118.08	408	KM 133.06	412	KM 162.03	415
KK 313.03	402	KK 347.03	405	KM 118.10	408	KM 133.08	412	KM 162.05	415
KK 313.04	402	KK 347.04	405	KM 118.12	408	KM 133.10	412	KM 162.06	415
KK 313.05	402	KK 347.05	405	KM 118.14	408	KM 133.12	412	KM 162.08	415
KK 313.06	402	KK 347.06	405	KM 119.04	408	KM 134.07	413	KM 162.09	415
KK 320.10	403	KK 348.01	405	KM 119.06	408	KM 134.10	413	KM 170.06	415
KK 320.20	403	KK 348.02	405	KM 119.08	408	KM 134.15	413	KM 170.13	415
KK 321.01	403	KK 348.10	405	KM 119.10	408	KM 134.20	413	KM 170.19	415
KK 321.02	403	KK 348.20	405	KM 119.12	408	KM 134.25	413	KM 170.25	415
KK 322.10	403	KK 350.01	405	KM 119.14	408	KM 134.30	413	KM 170.32	415
KK 322.20	403	KK 350.02	405	KM 122.06	409	KM 135.07	413	KM 172.06	416
KK 323.01	403	KK 350.03	405	KM 122.08	409	KM 135.10	413	KM 172.13	416
KK 323.02	403	KK 352.13	405	KM 122.10	409	KM 135.15	413	KM 172.19	416
KK 324.02	403	KK 352.14	405	KM 122.12	409	KM 135.20	413	KM 172.25	416
KK 324.03	403	KK 352.17	405	KM 122.15	409	KM 135.25	413	KM 172.32	416
KK 324.04	403	KK 354.13	406	KM 122.20	409	KM 135.30	413	KM 173.06	416
KK 324.05	403	KK 354.16	406	KM 122.25	409	KM 136.02	413	KM 173.13	416
KK 324.06	403	KK 354.20	406	KM 123.06	409	KM 136.03	413	KM 173.19	416
KK 324.07	403	KK 356.21	406	KM 123.08	409	KM 136.04	413	KM 173.25	416
KK 324.08	403	KK 358.00	406	KM 123.10	409	KM 136.06	413	KM 173.32	416
KK 324.10	403	KK 358.01	406	KM 123.12	409	KM 136.08	413	KM 176.06	416
KK 325.02	403	KK 358.12	406	KM 123.15	409	KM 136.10	413	KM 176.13	416
KK 325.03	403	KK 362.00	406	KM 123.20	409	KM 136.12	413	KM 176.19	416
KK 325.04	403	KK 362.01	406	KM 123.25	409	KM 136.15	413	KM 176.25	416
KK 325.05	403	KK 362.12	406	KM 124.06	409	KM 136.52	413	KM 176.32	416
KK 325.06	403			KM 124.08	409	KM 136.53	413	KM 177.06	416
KK 325.07	403	KM		KM 124.10	409	KM 136.54	413	KM 177.13	416
KK 325.08	403	KM 100.04	407	KM 124.12	409	KM 136.56	413	KM 177.19	416
KK 325.10	403	KM 100.06	407	KM 124.15	409	KM 136.58	413	KM 177.25	416
KK 328.01	403	KM 100.08	407	KM 124.20	409	KM 136.60	413	KM 177.32	416
KK 328.10	403	KM 100.10	407	KM 124.25	409	KM 136.62	413		
KK 328.20	403	KM 100.12	407	KM 126.06	410	KM 136.65	413	KN	
KK 328.30	403	KM 100.14	407	KM 126.08	410	KM 138.15	414	KN 181.30	417
KK 328.40	403	KM 100.16	407	KM 126.10	410	KM 138.20	414	KN 183.27	417
KK 328.50	403	KM 101.04	407	KM 126.12	410	KM 138.25	414	KN 198.02	417
KK 334.10	404	KM 101.06	407	KM 126.15	410	KM 138.30	414	KN 198.03	417
KK 334.20	404	KM 101.08	407	KM 126.20	410	KM 138.38	414	KN 198.04	417
KK 334.30	404	KM 101.10	407	KM 126.25	410	KM 138.44	414	KN 198.05	417
KK 335.01	404	KM 101.12	407	KM 127.06	410	KM 138.50	414	KN 198.06	417
KK 335.02	404	KM 101.14	407	KM 127.08	410	KM 139.15	414	KN 198.08	417
KK 335.03	404	KM 101.16	407	KM 127.10	410	KM 139.20	414	KN 198.09	417
KK 335.04	404	KM 102.04	407	KM 127.12	410	KM 139.25	414	KN 198.10	417
KK 335.05	404	KM 102.06	407	KM 127.15	410	KM 139.30	414	KN 400.01	418
KK 335.06	404	KM 102.08	407	KM 127.20	410	KM 139.38	414	KN 400.02	418
KK 336.25	404	KM 102.10	407	KM 127.25	410	KM 139.44	414	KN 400.03	418
KK 337.25	404	KM 102.12	407	KM 129.50	411	KM 139.50	414	KN 400.04	418
KK 339.25	404	KM 102.14	407	KM 129.60	411	KM 154.06	414	KN 400.10	418
KK 340.01	404	KM 102.16	407	KM 129.70	411	KM 154.09	414	KN 400.11	418
KK 340.02	404	KM 105.02	407	KM 130.00	411	KM 154.13	414	KN 400.12	418
KK 340.03	404	KM 105.03	407	KM 130.05	411	KM 154.16	414	KN 400.20	418
KK 340.04	404	KM 105.04	407	KM 130.10	411	KM 154.19	414	KN 400.21	418
KK 340.05	404	KM 105.05	407	KM 130.16	411	KM 154.25	414	KN 400.25	418
KK 340.06	404	KM 105.06	407	KM 130.25	411	KM 154.32	414	KN 400.26	418
KK 342.10	404	KM 106.02	407	KM 130.55	411	KM 155.06	414	KN 400.30	418
KK 342.20	404	KM 106.03	407	KM 130.60	411	KM 155.09	414	KN 401.18	419
KK 342.30	404	KM 106.04	407	KM 130.66	411	KM 155.13	414	KN 402.19	419
KK 342.40	404	KM 106.05	407	KM 130.85	411	KM 155.16	414	KN 411.05	419
KK 344.01	405	KM 106.06	407	KM 130.99	411	KM 155.19	414	KN 411.06	419
KK 344.02	405	KM 109.02	408	KM 131.05	412	KM 155.25	414	KN 411.07	419
KK 344.03	405	KM 109.03	408	KM 131.10	412	KM 155.32	414	KN 418.15	419
KK 344.04	405	KM 109.04	408	KM 131.15	412	KM 156.09	415	KN 419.15	419
KK 344.05	405	KM 109.05	408	KM 131.55	412	KM 156.14	415	KN 420.16	419
KK 344.06	405	KM 109.06	408	KM 131.60	412	KM 156.19	415	KN 421.16	419
KK 345.01	405	KM 110.02	408	KM 131.65	412	KM 156.25	415	KN 427.21	419
KK 345.02	405	KM 110.03	408	KM 132.04	412	KM 156.32	415	KN 428.18	420
KK 345.03	405	KM 110.04	408	KM 132.06	412	KM 157.09	415	KN 430.20	420



KN 431.20	420	KV 112.27	427	KV 656.00	438	PC 551.23	449	PV 530.20	458
KN 432.18	420	KV 114.31	427	KV 656.01	438	PC 554.25	450	PV 600.00	459
KN 432.20	420	KV 200.01	428	KV 660.31	439	PC 555.25	450	PV 600.01	459
KN 433.18	420	KV 200.02	428	KV 662.29	439	PC 560.22	450	PV 600.02	459
KN 434.13	421	KV 200.03	428	KV 664.18	439	PC 560.25	450	PV 602.02	459
KN 435.18	420	KV 204.01	428	KV 664.23	439	PC 560.28	450	PV 602.02	459
KN 436.16	421	KV 204.02	428	KV 960.01	440	PC 561.22	451	PV 602.03	459
KN 438.19	420	KV 204.03	428	KV 960.02	440	PC 561.25	451	PV 604.20	459
KN 439.06	421	KV 208.20	428	KV 964.10	440	PC 561.28	451	PV 604.25	459
KN 439.08	421	KV 214.01	428	KV 967.10	440	PC 570.33	451	PV 604.30	459
KN 441.17	421	KV 214.02	428	KV 968.00	440	PC 571.33	451		
KN 443.17	421	KV 216.01	428	KV 968.01	440	PC 580.24	452	SR	
KN 445.17	421	KV 218.22	429	KV 968.02	440	PC 581.26	452	SR 085.27	476
KN 447.17	421	KV 220.17	429	KV 968.03	440	PC 581.28	452	SR 091.20	476
KN 448.24	421	KV 221.00	429	KV 970.17	441	PC 583.23	453	SR 091.30	476
KN 449.24	421	KV 224.18	429	KV 972.16	441	PC 585.24	453	SR 093.23	476
KN 450.01	422	KV 234.19	429	KV 973.01	441	PC 587.30	453	SR 100.01	477
KN 450.02	422	KV 236.01	429	KV 974.01	441	PC 721.28	454	SR 150.10	477
KN 450.03	422	KV 236.02	429	KV 974.16	441	PC 721.35	454	SR 150.20	477
KN 450.04	422	KV 238.26	430	KV 975.17	441	PC 721.42	454	SR 162.20	481
KN 450.05	422	KV 240.29	430	KV 976.01	441	PC 722.28	454	SR 164.20	481
KN 450.06	422	KV 242.24	430	KV 978.13	441	PC 722.35	454	SR 170.16	478
KN 450.07	422	KV 244.24	431			PC 722.42	454	SR 170.17	478
KN 461.05	422	KV 246.24	431	PC		PC 723.28	454	SR 170.22	478
KN 461.10	422	KV 254.22	431	PC 274.21	444	PC 723.35	454	SR 170.23	478
KN 461.15	422	KV 255.00	431	PC 274.23	444	PC 723.42	454	SR 170.24	478
KN 461.20	422	KV 256.18	432	PC 275.21	444	PC 724.28	454	SR 170.27	478
KN 461.25	422	KV 258.10	432	PC 275.23	444	PC 724.35	454	SR 170.29	478
KN 467.20	422	KV 258.35	432	PC 276.18	444	PC 724.42	454	SR 170.31	478
KN 469.22	422	KV 258.50	432	PC 277.18	444	PC 725.00	454	SR 170.34	478
		KV 258.70	432	PC 286.21	444	PC 725.42	454	SR 170.38	478
		KV 260.01	432	PC 286.23	444	PC 727.42	454	SR 176.33	478
KO		KV 260.02	432	PC 287.21	444	PC 729.42	454	SR 178.33	478
KO 130.14	423	KV 261.24	432	PC 287.23	444	PC 731.42	454	SR 200.08	479
KO 132.18	423	KV 262.19	432	PC 288.25	444	PC 733.42	454	SR 200.12	479
KO 134.21	423	KV 368.25	433	PC 289.25	444			SR 200.14	479
KO 136.14	423	KV 368.35	433	PC 304.22	445	PF		SR 200.16	479
KO 144.00	424	KV 372.17	433	PC 304.25	445	PF 282.15	455	SR 200.17	479
KO 145.01	424	KV 374.25	433	PC 304.28	445	PF 741.38	455	SR 200.19	479
KO 145.02	424	KV 378.25	433	PC 305.22	445	PF 756.20	455	SR 200.20	479
KO 145.03	424	KV 380.25	433	PC 305.25	445	PF 758.21	455	SR 200.23	479
KO 145.04	424	KV 480.28	434	PC 305.28	445			SR 200.24	479
KO 145.05	424	KV 481.24	434	PC 352.25	446	PU		SR 200.29	479
KO 145.06	424	KV 482.22	434	PC 415.15	446	PU 605.21	456	SR 200.29	479
KO 145.07	424	KV 535.01	435	PC 419.21	446	PU 613.15	456	SR 200.33	479
KO 145.08	424	KV 535.02	435	PC 425.29	446	PU 615.15	456	SR 200.34	479
KO 145.09	424	KV 535.03	435	PC 433.35	446	PU 619.20	456	SR 200.38	479
KO 152.00	424	KV 542.21	435	PC 464.30	447	PU 625.19	456	SR 200.39	479
KO 152.01	424	KV 565.16	436	PC 465.30	447	PU 647.00	457	SR 224.11	480
KO 152.02	424	KV 565.21	436	PC 474.30	447	PU 651.15	457	SR 225.11	480
KO 152.03	424	KV 581.01	436	PC 475.30	447	PU 669.01	457	SR 226.11	480
KO 152.04	424	KV 581.05	436	PC 496.05	448	PU 669.02	457	SR 231.04	480
KO 152.05	424	KV 585.01	436	PC 496.07	448	PU 669.03	457	SR 231.06	480
KO 152.06	424	KV 585.02	436	PC 496.10	448	PU 675.01	457	SR 231.08	480
KO 152.07	424	KV 586.18	436	PC 497.20	448	PU 675.02	457	SR 231.11	480
KO 152.08	424	KV 587.19	436	PC 498.08	448	PU 675.03	457	SR 231.12	480
KO 152.09	424	KV 588.12	436	PC 498.23	448	PU 679.01	457	SR 231.12	480
KO 156.00	425	KV 589.18	437	PC 520.07	448	PU 679.02	457	SR 231.16	480
KO 156.08	425	KV 589.27	437	PC 520.10	448			SR 231.18	480
KO 158.00	425	KV 601.02	437	PC 522.00	448	PV		SR 235.11	480
KO 158.06	425	KV 603.03	437	PC 524.15	448	PV 530.00	458	SR 235.12	480
KO 606.00	426	KV 603.06	437	PC 550.13	449	PV 530.01	458	SR 235.14	480
KO 606.01	426	KV 652.01	438	PC 550.16	449	PV 530.10	458	SR 235.16	480
KO 611.01	426	KV 652.02	438	PC 550.18	449	PV 530.11	458	SR 235.18	480
KO 620.01	426	KV 652.03	438	PC 550.21	449	PV 530.12	458	SR 240.11	480
		KV 652.04	438	PC 550.23	449	PV 530.13	458	SR 254.01	480
KV		KV 652.05	438	PC 551.13	449	PV 530.14	458	SR 256.02	480
KV 101.35	427	KV 654.40	438	PC 551.16	449	PV 530.15	458	SR 256.05	480
KV 101.92	427	KV 654.45	438	PC 551.18	449	PV 530.16	458	SR 256.10	480
KV 101.95	427	KV 654.55	438	PC 551.21	449	PV 530.17	458	SR 256.20	480
KV 110.23	427								



SR 300.50	481	SR 412.27	486	SV 455.24	479	UK 362.02	470	UV 765.16	474
SR 300.65	481	SR 412.30	486	SV 455.25	479	UK 362.03	470	UV 765.21	474
SR 300.75	481	SR 412.33	486	SV 455.29	479	UK 746.20	465	UV 765.26	474
SR 302.50	481	SR 419.20	486	SV 455.30	479	UK 840.26	465	UV 765.32	474
SR 302.65	481	SR 430.06	487	SV 455.33	479			UV 792.39	474
SR 302.75	481	SR 430.07	487	SV 455.34	479	UQ		UV 793.35	474
SR 309.65	481	SR 431.06	487	SV 455.37	479	UQ 162.01	471	UV 817.12	465
SR 310.65	481	SR 431.10	487	SV 455.38	479	UQ 162.02	471		
SR 321.23	483	SR 432.08	487	SV 455.39	479	UQ 162.03	471	WA	
SR 321.30	483	SR 432.12	487			UQ 170.01	471	WA 301.10	492
SR 321.31	483	SR 435.15	487	UC		UQ 170.02	471	WA 304.10	492
SR 321.35	483	SR 452.10	479	UC 101.23	462	UQ 170.03	471	WA 305.10	492
SR 321.40	483	SR 452.15	479	UC 103.22	462	UQ 170.04	471	WA 320.13	492
SR 324.21	483	SR 452.20	479	UC 105.22	462	UQ 170.05	471	WA 320.15	492
SR 324.24	483	SR 452.21	479	UC 107.22	462	UQ 170.06	471	WA 378.10	492
SR 324.30	483	SR 452.24	479	UC 109.19	462	UQ 170.07	471	WA 379.10	492
SR 324.31	483	SR 452.25	479	UC 111.19	462	UQ 170.08	471		
SR 324.35	483	SR 452.29	479	UC 115.01	463	UQ 170.09	471	WI	
SR 324.40	483	SR 452.30	479	UC 115.02	463	UQ 170.10	471	WI 331.14	492
SR 324.42	483	SR 452.33	479	UC 204.20	463	UQ 170.11	471	WI 336.14	492
SR 335.01	482	SR 452.34	479	UC 205.20	463	UQ 170.12	471	WI 336.16	492
SR 335.02	482	SR 452.37	479	UC 214.20	463	UQ 170.13	471	WI 341.11	493
SR 335.03	482	SR 452.38	479	UC 215.20	463			WI 341.13	493
SR 335.05	482	SR 452.39	479	UC 217.22	463	UV		WI 341.15	493
SR 337.01	482	SR 602.25	487	UC 223.23	463	UV 599.00	472	WI 347.13	493
SR 337.02	482	SR 602.50	487	UC 225.23	463	UV 599.08	472	WI 353.12	493
SR 340.02	482	SR 610.20	487	UC 451.24	464	UV 599.10	472	WI 360.11	493
SR 340.23	483	SR 620.75	487	UC 453.24	464	UV 599.12	472	WI 360.13	493
SR 348.22	483	SR 662.75	487	UC 461.23	464	UV 599.14	472	WI 360.15	493
SR 358.25	484	SR 673.17	488	UC 463.23	464	UV 599.16	472	WI 365.11	493
SR 358.32	484	SR 673.25	488	UC 465.24	464	UV 599.18	472	WI 365.13	493
SR 360.30	484	SR 673.27	488	UC 875.08	465	UV 599.20	472	WI 373.10	493
SR 360.50	484	SR 702.23	488	UC 877.08	465	UV 599.22	472		
SR 360.51	484	SR 702.31	488	UC 881.11	465	UV 599.24	472	WV	
SR 360.52	484	SR 712.22	488			UV 599.26	472	WV 101.00	494
SR 360.75	484	SR 740.30	488	UD		UV 599.28	472	WV 101.01	495
SR 360.76	484	SR 741.30	488	UD 401.21	466	UV 599.30	472	WV 101.02	495
SR 360.77	484	SR 750.36	488	UD 403.22	466	UV 599.32	472	WV 101.03	495
SR 360.98	484	SR 800.10	476	UD 405.22	466	UV 599.34	472	WV 101.04	495
SR 360.99	484	SR 800.60	490	UD 407.22	466	UV 599.36	472	WV 101.05	495
SR 365.50	484	SR 805.14	476	UD 475.00	467	UV 721.06	472	WV 101.06	495
SR 365.75	484	SR 808.14	476	UD 503.00	467	UV 721.08	472	WV 101.07	495
SR 365.99	484	SR 808.24	489	UD 508.00	467	UV 721.10	472	WV 101.08	495
SR 399.35	485	SR 808.48	489	UD 510.00	467	UV 721.12	472	WV 101.09	495
SR 399.50	485	SR 808.75	489	UD 512.00	468	UV 721.14	472	WV 101.10	495
SR 399.60	485	SR 808.99	489	UD 513.00	468	UV 721.16	472	WV 101.11	495
SR 400.23	485	SR 809.24	489	UD 513.01	468	UV 721.18	472	WV 102.02	495
SR 400.26	485	SR 809.26	489	UD 527.27	468	UV 721.20	472	WV 104.70	496
SR 400.27	485	SR 809.27	489	UD 547.26	468	UV 721.22	472	WV 112.12	496
SR 400.30	485	SR 809.48	489			UV 721.24	472	WV 120.12	496
SR 400.32	485	SR 809.75	489	UF		UV 723.06	472	WV 146.04	496
SR 400.42	485	SR 809.99	489	UF 811.20	465	UV 723.08	472	WV 147.04	496
SR 402.23	485	SR 850.07	490	UF 811.28	465	UV 723.10	472	WV 148.12	496
SR 402.26	485	SR 850.10	490			UV 723.12	472	WV 149.12	496
SR 402.30	485	SR 860.01	490	UK		UV 723.14	472	WV 301.03	497
SR 402.32	485	SR 860.02	490	UK 331.01	469	UV 723.16	472	WV 303.03	497
SR 402.42	485	SR 868.01	490	UK 331.02	469	UV 723.18	472	WV 304.07	497
SR 411.16	486	SR 868.05	490	UK 331.03	469	UV 723.20	472	WV 306.08	497
SR 411.20	486			UK 331.04	469	UV 723.22	472	WV 306.13	497
SR 411.21	486	SV		UK 340.01	469	UV 723.24	472	WV 351.50	497
SR 411.23	486	SV 409.23	485	UK 340.02	469	UV 740.00	473	WV 386.10	493
SR 411.26	486	SV 409.26	485	UK 340.03	469	UV 745.00	473	WV 386.12	493
SR 411.27	486	SV 409.27	485	UK 340.04	469	UV 755.00	473	WV 389.16	493
SR 411.30	486	SV 409.30	485	UK 340.05	469	UV 756.00	473	WV 454.15	498
SR 411.33	486	SV 409.32	485	UK 340.06	469	UV 757.00	473	WV 455.15	498
SR 412.16	486	SV 409.42	485	UK 340.07	469	UV 760.00	474	WV 470.58	498
SR 412.20	486	SV 455.10	479	UK 340.08	469	UV 763.00	474	WV 474.55	498
SR 412.21	486	SV 455.15	479	UK 355.28	470	UV 765.08	474		
SR 412.23	486	SV 455.20	479	UK 358.27	470	UV 765.11	474		
SR 412.26	486	SV 455.21	479	UK 362.01	470	UV 765.13	474		





CEATEC Medizintechnik GmbH

Untere Hauptstrasse 6
D - 78573 Wurmlingen

Tel.: +49-7461-9348-0
Fax: +49-7461-9348-19

web: www.ceatec.de
e-mail: info@ceatec.de