

MEDICON eG · GERMANY · 47° 57' 31.4" N · 8° 46' 58.6" E



neuro SPINALIS

Instrumente für die spinale Neurochirurgie
Instruments for Spinal Neurosurgery
Instrumentos para la neurocirugía espinal
Instruments pour la neurochirurgie spinale
Strumenti per la neurochirurgia spinale

medicon[®]





neuro SPINALIS

Instrumente für die spinale Neurochirurgie
Instruments for Spinal Neurosurgery
Instrumentos para la neurocirugía espinal
Instruments pour la neurochirurgie spinale
Strumenti per la neurochirurgia spinale

Die Entwicklung, Herstellung und der Vertrieb chirurgischer Instrumente und Implantate haben bei uns eine jahrzehntelange Tradition. In unseren 11 Mitgliedsbetrieben werden über 35.000 verschiedene Artikel für die Humanmedizin gefertigt.

Wir haben es uns zur Aufgabe gemacht, Chirurgen und OP-Personal der Neurochirurgie mit innovativen Implantaten und Instrumenten zu versorgen, welche die Fortschritte der operativen Behandlung unterstützen.

Mit Verantwortung und Engagement bündeln wir unsere Aktivitäten in drei Kernkompetenzen.

Our company has decades of experience in developing, manufacturing and selling surgical instruments and implants. Our 11 member companies produce over 35,000 different items for human medicine.

We have made it our goal to supply surgeons and surgical personnel in Neurosurgery with innovative implants and instruments, which support the progress in surgical treatment.

With responsibility and commitment, we focus our activities on three core competences.



El desarrollo, la fabricación y la distribución de implantes e instrumentos quirúrgicos representa para nosotros décadas de tradición. En los talleres de nuestros 11 socios se fabrican más de 35.000 artículos diferentes para la medicina humana.

Nos hemos propuesto la tarea de abastecer a cirujanos y a personal de quirófano de la neurocirugía con innovadores implantes e instrumentos que respaldan el progreso del tratamiento quirúrgico.

Con responsabilidad y compromiso, centramos nuestra actividad en tres competencias básicas.

Le développement, la fabrication et la vente d'instruments chirurgicaux et d'implants ont une tradition longue depuis plusieurs décennies chez Medicon.

Nos 11 entreprises membres produisent plus de 35.000 articles différents dans le secteur de la médecine.

Nous nous sommes fixés pour objectif de fournir aux chirurgiens et au personnel opératoire actifs dans le secteur de la neurochirurgie des implants et instruments novateurs suivant les progrès du traitement opératoire.

Avec conscience et engagement, nous regroupons nos activités dans trois compétences majeures.

Lo sviluppo, la produzione e la distribuzione di strumenti chirurgici e impianti hanno da noi una tradizione pluridecennale.

Nelle nostre 11 aziende associate, vengono fabbricati oltre 35.000 diversi articoli per la medicina umana.

Il compito che ci siamo proposti è quello di fornire ai chirurghi e al personale di sala operatoria di neurochirurgia impianti e strumenti innovativi che supportano i progressi del trattamento chirurgico.

Con responsabilità e impegno riuniamo le nostre attività in tre competenze di base.



III CMF

Das Kompetenzfeld **CMF** kombiniert unsere modular aufgebauten Systeme für die Distraction und Osteosynthese in der kranio-maxillo-fazialen Chirurgie mit anwendungs-optimierten Lösungen und intuitiver Bedienbarkeit zu einem zukunfts-orientierten Konzept.

The competence field **CMF** combines our modular systems for distraction and osteosynthesis in Cranio-Maxillofacial surgery with application-optimised solutions and intuitive operation to produce a forward-looking concept.

II SURGICAL

Das Kompetenzfeld **SURGICAL** vernetzt unsere mehr als siebenjährige Erfahrung als Medizintechnik-Unternehmen mit weit über 35.000 Produkten, die nahezu alle Indikationen der einzelnen chirurgischen Fachbereiche abdecken.

The competence field **SURGICAL** links our more than seventy years of experience as a medical technology company with over 35,000 products covering nearly all indications of the individual surgical specialty fields.

III NEURO+SPINE

Das Kompetenzfeld **NEURO+SPINE** konzentriert sich auf unser Produkt-Portfolio von qualitativ hochwertigen Instrumenten und innovativen Implantaten für die Neurochirurgie mit dem Fokus der produktbezogenen Spezialisierung als Grundlage einer transparenten Vertriebsstrategie.

The competence field **NEURO+SPINE** focuses on our product portfolio of high-quality instruments and innovative implants for Neurosurgery with the main emphasis on product-related specialisation as a basis for a transparent sales strategy.

El área de especialización **CMF** combina nuestro sistema modular para la distensión y osteosíntesis en la cirugía cráneo-maxilofacial con soluciones orientadas a la aplicación y un manejo intuitivo para desarrollar un concepto enfocado hacia el futuro.

Le domaine de compétence **CMF** associe nos systèmes modulaires utilisés pour la distraction et ostéosynthèse en chirurgie crânio-maxillo-faciale à des solutions d'application optimisées et à une manipulation intuitive. Le résultat: Un concept d'avenir.

L'area di competenza **CMF** associa i nostri sistemi componibili per la distrazione e la osteosintesi nella chirurgia cranio-maxillo-facciale a soluzioni ottimizzate nell'applicazione e manipolazione intuitiva, per un concetto orientato al futuro.

El área de especialización **SURGICAL** fusiona nuestros más de 70 años de experiencia como empresa de tecnología médica con más de 35.000 productos que cubren casi todas las indicaciones de cada una de las disciplinas quirúrgicas.

Le domaine de compétence **SURGICAL** allie notre expérience de plus de 70 années dans le secteur des techniques médicales à plus de 35.000 produits, couvrant la quasi-totalité des indications de la chirurgie actuelle.

L'area di competenza **SURGICAL** collega la nostra ultrasettantennale esperienza aziendale nel campo della tecnica medica con oltre 35.000 prodotti che soddisfano quasi tutte le indicazioni delle singole aree di specializzazione chirurgiche.

El área de especialización **NEURO+SPINE** se centra en nuestra cartera de productos de instrumentos de alta calidad e implantes innovadores para la neurocirugía considerando la especialización relacionada con los productos como base de una estrategia de ventas transparente.

Le domaine de compétence **NEURO+SPINE** se concentre sur notre gamme d'instruments de grande qualité et d'implants novateurs pour la neurochirurgie, avec une spécialisation sur les produits comme base d'une stratégie de vente transparente.

L'area di competenza **NEURO+SPINE** si concentra sul nostro portfolio di strumenti di alta qualità e impianti innovativi per la neurochirurgia, e si propone come focus la specializzazione del prodotto come base di una trasparente strategia di distribuzione.

Der Ihnen vorliegende Katalog "Instrumente für die spinale Neurochirurgie" bleibt unser Eigentum, auch wenn eine Leih- oder Schutzgebühr bezahlt wurde. Er darf nur zum Einkauf und Vertrieb der darin beschriebenen MEDICON-Produkte durch den dazu autorisierten Fachhandel und für die Bedarfsbeschaffung durch den jeweiligen Anwender verwendet werden. Seine Verwendung gegen unsere Interessen berechtigt uns zur sofortigen Rückforderung und möglichen weitergehenden Maßnahmen. Ohne unsere ausdrückliche, schriftliche Genehmigung darf dieser Katalog weder im Gesamten noch auszugsweise nachgedruckt oder kopiert werden.

This present "Instruments for Spinal Neurosurgery" catalogue remains exclusively our property even if a lending fee or charge has been paid for it. It shall only be used by specialized dealers to buy and sell MEDICON products or by individual users to meet their own requirements. In case of misuse we are entitled to recall the catalogue immediately and to take further steps if necessary. It is not allowed to reprint or copy this catalogue in whole or in parts without our written permission.

El presente catálogo "Instrumentos para la neurocirugía espinal" sigue siendo nuestra propiedad aunque se ha pagado ciertos derechos de préstamo. Debe servir a los revendedores autorizados del ramo exclusivamente para la compra y la distribución de los productos MEDICON que describe, y a los especialistas y usuarios particulares para escoger los instrumentos necesarios para su abastecimiento. Su empleo abusivo en perjuicio de nuestros intereses, nos da derecho a exigir su devolución inmediata y a tomar todas las medidas ulteriores que juzguemos necesarias. Sin nuestro permiso expreso por escrito es prohibido reproducir o copiar este catálogo, tanto en su totalidad como en extractos.

Le présent catalogue "Instruments pour la neurochirurgie spinale" demeure notre propriété, même après acquittement d'une taxe autorisée ou taxe de prêt. Il ne peut être utilisé que pour l'achat ou la vente des produits MEDICON qui y sont décrits, par des spécialistes y étant autorisés et par l'utilisateur pour l'approvisionnement de ses besoins. Son utilisation contre nos intérêts nous autorise à une demande en restitution immédiate et à la prise éventuelle de mesures disciplinaires. Sans autorisation formelle écrite, ce catalogue ne peut être ni réimprimé, ni copié, que ce soit complètement ou partiellement.

Il presente catalogo "Strumenti per la neurochirurgia spinale" rimane di nostra proprietà anche se è stato pagato un diritto di noleggio o di proprietà riservata. Esso può essere adoperato soltanto per l'acquisto e la vendita dei prodotti MEDICON ivi descritti attraverso il commercio specializzato e autorizzato o per l'approvvigionamento tramite chi, di volta in volta, li impiega. L'uso del catalogo contro i nostri interessi ci autorizza al suo immediato ritiro e possibili ulteriori provvedimenti. Senza la nostra esplicita autorizzazione scritta questo catalogo non può essere ristampato o copiato nè integralmente nè parzialmente.

Modelländerungen vorbehalten
Patterns are subject to change
Salvo modificaciones
Tous droits réservés des changements de modèle
Ci riserviamo la facoltà di cambiamenti nei modelli

Für Druckfehler übernehmen wir keinerlei Haftung
We are not liable for misprints
Declinamos toda responsabilidad por los errores de impresión que pueda contener este documento
Nous déclinons toute responsabilité en cas d'erreurs d'impression
Non ci assumiamo nessuna responsabilità per eventuali errori di stampa

Gedruckt in Deutschland
Printed in Germany
Impreso en Alemania
Imprimé en Allemagne
Stampato in Germania
Trykket i Tyskland

© Copyright 10/2013, MEDICON eG, Tuttlingen, Germany

**Standardinstrumente
Basic Instruments
Instrumentos básicos
Instruments de base
Strumenti di base**

A

**Instrumente für die spinale Neurochirurgie
Instruments for Spinal Neurosurgery
Instrumentos para la neurocirugía espinal
Instruments pour la neurochirurgie spinale
Strumenti per la neurochirurgia spinale**

B

**Implantate für die Wirbelsäule
Implants for Spine
Implantes para la columna vertebral
Implants pour la colonne vertébrale
Impianti per colonna vertebrale**

C

**Siebvorschläge
Set Suggestions
Proposiciones de juegos
Propositions pour boîtes
Proposte di set**

D

**Alphabetischer und numerischer Index
Alphabetical and Numerical Index
Indice alfabético y numérico
Index alphabétique et numérique
Indice alfabetico e numerico**

E

A

Standardinstrumente Basic Instruments Instrumentos básicos Instruments de base Strumenti di base

A01	Skalpellsklingen und Skalpellgriffe Scalpel blades and scalpel handles Hojas de bisturí y mangos de bisturí Lames de bistouris et manches pour bistouris Lame per bisturi e manici per bisturi	3
A02	Scheren Scissors Tijeras Ciseaux Forbici	7
A03	Pinzetten Forceps Pinzas Pincas Pinze	31
A04	Bipolare Pinzetten Bipolar forceps Pinzas bipolares Pincas bipolaires Pinze bipolari	57
A05	Nadelhalter Needle holders Porta-agujas Porte-aiguilles Portaghi	65
A06	Saug- und Spülinstrumente Suction and irrigating instruments Instrumentos de aspiración y de lavado Instruments à aspiration et à irrigation Strumenti per aspirazione e lavaggio	79
A07	Titan-Clips und Anlegezangen Titanium clips and applying forceps Clips de titanio y pinzas para aplicar Clips en titane et pincas à poser Clip di titanio e pinze per applicare	85
A08	Wundhaken und Wundspreizer Retractors and self-retaining retractors Separadores y separadores autoestáticos Ecarteurs et écarteurs autostatiques Divaricatori e divaricatori autostatici	87
A09	Elevatoren und Raspatorien Elevators and raspatories Elevadores y legras Elévateurs et rugines Elevatori e periostotomi	99
A10	Hämmer, Stößel, Meißel und Löffel Mallets, pestles, chisels and curettes Martillos, pisón, cinceles y cucharillas Maillets, pilon, ciseaux burins et curettes Martelli, pestone, scalpelli e cucchiai	109
A11	Hohlmeißel- und Knochensplitterzangen Bone rongeurs forceps and bone cutting forceps Pinzas-gubias y pinzas cortantes para huesos Pincas-gouges et pincas coupantes à os Pinze-sgorbie e pinze ossivore	129

B

Instrumente für die spinale Neurochirurgie Instruments for Spinal Neurosurgery Instrumentos para la neurocirugía espinal Instruments pour la neurochirurgie spinale Strumenti per la neurochirurgia spinale

B01	Minimal-invasive Zugangstechniken Minimally invasive approaches Técnicas de acceso mínimamente invasivas Techniques d'accès mini-invasives Tecniche d'accesso mini-invasive	141
CERVICALINO PICCOLINO	Minimal-invasive Spreizersysteme für die Wirbelsäule Minimally invasive spinal spreading systems Sistemas de separadores mínimamente invasivos para la columna vertebral Systèmes d'écarteurs mini-invasives pour la colonne vertébrale Sistemi di divaricazione mini-invasivi per la colonna vertebrale	143
MICRODISC-XS	Miniaturisierte (XS) Mikrodiskektomie Miniaturized (XS) micro-discectomy Microdiscectomía miniaturizada (XS) Mikrodiscectomie miniature (XS) Mikro discectomia miniaturizzata (XS)	157
M.A.P.N	Mikroskopisch assistierte perkutane Nukleotomie Microscopically assisted percutaneous nucleotomy Nucleotomía percutánea microscópicamente asistida Nucléotomie percutanée assistée au microscope Nucleotomia percutanea assistita al microscopio	167
THORAMIC	Thorakoskopische Minimal-Invasive Chirurgie Thoracoscopic minimally invasive surgery Cirugía toracoscópica mínimamente invasiva Chirurgie thoracoscopique mini-invasive Chirurgia toracoscopica mini-invasiva	177
B02	Spreizersysteme für die Wirbelsäule Spinal spreading systems Sistemas de separadores para la columna vertebral Systèmes d'écarteurs pour la colonne vertébrale Sistemi di divaricazione per la colonna vertebrale	191
B03	Zervikales Wirbelkörper-Distraktionssystem Cervical vertebral body distraction system Sistema de distractor para el cuerpo vertebral cervical Système distracteur pour le corps vertébral cervical Sistema distrattore per il corpo vertebrale cervicale	233
B04	Stanzen und Rongeure Rongeurs Pinzas saca-bocadas y pinzas cortantes Pinces emporte-pièce et rongeurs Laminotomi e pinze per laminectomia	237
B05	Haken und Dissektoren Hooks and dissectors Seperadores y disectores Crochets et dissecteurs Uncini e dissettori	271
B06	Diamantmesser und Mikro-Instrumente Diamond knives and micro instruments Cuchillos de diamante y micro instrumentos Couteau de diamant et micro instruments Bisturi diamantati e micro strumenti	291
B07	Spongiosaentnahme aus dem Beckenkamm Cancellous bone extraction from the pelvic crest Extracción esponjosa de la cresta iliaca Extraction spongieuse de l'os iliaque Estrazione spongiosa dalla cresta iliaca	303
B08	Druckluftmotorensystem Pneumatic high speed system Sistema de motor neumático Système de moteur pneumatique Sistema motore pneumatico	307

C

Implantate für die Wirbelsäule Implants for Spine Implantes para la columna vertebral Implants pour la colonne vertébrale Impianti per colonna vertebrale

C01	Set zur C2/C1-Verschraubung und Dens-Fixierung Set for screw joint C2/C1 and dens fixation Juego para atornillar las vértebras C2/C1 y fijar la apófisis odontoides Set de vissage C2/C1 et de fixation du processus odontoïde Set per l'avvitamento C2/C1 e fissaggio del dente	322
C02	Wirbelkörperersatz für die zervikale Wirbelsäule Vertebral body replacement for cervical spine Sustitución de cuerpo vertebral para la columna vertebral cervical Le remplacement du corps vertébral pour la colonne vertébrale cervicale Sostituto del corpo vertebrale per la colonna vertebrale cervicale	324
C03	Implantate für die zervikale Wirbelsäule Implants for cervical spine Implantes para la columna vertebral cervical Implants pour la colonne vertébrale cervicale Impianti per la colonna vertebrale cervicale	326
C04	Implantate für die thorakale Wirbelsäule Implants for thoracic spine Implantes para la columna vertebral dorácica Implants pour la colonne vertébrale thoracique Impianti per la colonna vertebrale toracica	327
C05	Pedikelschraubensystem zur Stabilisierung der Wirbelsäule Pedicule screw system for stabilising the spine Sistema de tornillos pediculares para estabilizar la columna vertebral Système de vis pédiculaire destiné à stabiliser la colonne vertébrale Sistema di viti peduncolari per la stabilizzazione della colonna vertebrale	328

D

Siebvorschläge Set Suggestions Proposiciones de juegos Propositions pour boîtes Proposte di set

D01	Siebvorschlag für die spinale Mikrochirurgie Set suggestion for the spinal microsurgery Proposición de juego para la microcirugía espinal Proposition de boîte pour la microchirurgie spinale Proposta di set per la microchirurgia spinale	333
D02	Siebvorschlag für Operationen an der Halswirbelsäule Set suggestion for surgery of the cervical spine Proposición de juego para la cirugía de la columna vertebral cervical Proposition de boîte pour la chirurgie du colonne vertébrale cervicale Proposta di set per la chirurgia della colonna vertebrale cervicale	334
D03	Siebvorschlag für Operationen an der thorakalen und lumbalen Wirbelsäule Set Suggestion for surgery of the thoracic and lumbar spine Proposición de juego para la cirugía de la columna vertebral torácica y lumbar Proposition à boîte pour la chirurgie du colonne vertébrale thoracique et lombaire Proposta di set per la chirurgia della colonna vertebrale toracica e lombare	338

E

Alphabetischer und numerischer Index
Alphabetical and Numerical Index
Indice alfabético y numérico
Index alphabétique et numérique
Indice alfabetico e numerico

E01	Alphabetischer Index	DEUTSCH	345
E02	Alphabetical index	ENGLISH	351
E03	Indice alfabético	ESPAÑOL	357
E04	Index alphabétique	FRANÇAIS	363
E05	Indice alfabetico	ITALIANO	369
E06	Numerischer Index Numerical index Indice numérico Index numérique Indice numerico		376

Hinweise
Indications
Indicaciones
Indications
Indicazioni

Unsere Instrumenten-Abbildungen haben eine Größe von 50 %. Andere Darstellungsgrößen werden im Maßstab (zum Beispiel 1:1) angegeben. Die dazugehörigen Detailbilder sind in Originalgröße (100 %) abgebildet. Die angegebenen Bemaßungen unterliegen herstellungsbedingt einer Fertigungstoleranz.

In general the instrument illustrations are scaled to be 50 % of actual size. If other scales are used they are indicated (for example 1:1). The corresponding detailed tip illustrations are shown in actual size (100 %). The stated measurements may have a slight variation in permissible tolerances due to minor variations in manufacturing conditions.

Las ilustraciones de los instrumentos tienen un tamaño de 50 %. Otros tamaños de las ilustraciones serán indicados con la indicación en una escala (por ejemplo 1:1). Los imagenes detallados pertinentes son en su tamaño original (100 %). Las dimensiones indicadas son sujeto de tolerancias.

Nos illustrations d'instruments sont à 50 % de la taille réelle. D'autres dimensions de représentation sont données avec indication d'échelle (par exemple 1:1). Les images de détail sont projetées en taille réelle (100 %). Toutes les dimensions données ont une tolérance de fabrication.

Le illustrazioni dei nostri strumenti hanno una dimensione del 50 %. Altre dimensioni di raffigurazione sono segnate con una scala (per esempio 1:1). Le relative illustrazioni dettagliate sono illustrate in dimensioni originali (100 %). Le dimensioni indicate sono soggette a una tolleranza di fabbricazione.

Beispiel
 Example
 Ejemplo
 Exemple
 Esempio

Vorderansicht (Schere gerade)
 Front view (straight scissors)
 Vista frontal (tijera recta)
 Vue de face (ciseaux droits)
 Vista frontale (forbice retta)

Seitenansicht (Schere gebogen)
 Lateral view (curved scissors)
 Vista lateral (tijera curva)
 Vue laterale (ciseaux courbes)
 Vista laterale (forbice curva)

Darstellungsgröße
 Image sizes
 Tamaño de representación
 Dimension de représentation
 Dimensione di raffigurazione

1:1

Instrumentengröße
 Instrument size
 Tamaño del instrumento
 Taille des instruments
 Dimensione degli strumenti

Artikelnummer
 Item number
 Número de artículo
 Référence
 Codice

50 % = 7 cm

Mayo

14 cm - 5 1/2"	14 cm - 5 1/2"	
03.50.14	03.51.14	standard
203.50.14	203.51.14	supercut
213.50.14	213.51.14	blackline
03.50.64	03.51.64	"HM"
203.50.64	202.51.64	supercut plus
223.50.64	222.51.64	magiccut



Standardinstrumente
Basic Instruments
Instrumentos básicos
Instruments de base
Strumenti di base

A

neuro
SPINALIS

Standardinstrumente
Basic Instruments
Instrumentos básicos
Instruments de base
Strumenti di base

A01	Skalpellklingen und Skalpellgriffe Scalpel blades and scalpel handles Hojas de bisturi y mangos de bisturi Lames de bistouris et manches pour bistouris Lame per bisturi e manici per bisturi	3
A02	Scheren Scissors Tijeras Ciseaux Forbici	7
A03	Pinzetten Forceps Pinzas Pinces Pinze	31
A04	Bipolare Pinzetten Bipolar forceps Pinzas bipolares Pinces bipolaires Pinze bipolari	57
A05	Nadelhalter Needle holders Porta-agujas Porte-aiguilles Portaghi	65
A06	Saug- und Spülinstrumente Suction and irrigating instruments Instrumentos de aspiración y de lavado Instruments à aspiration et à irrigation Strumenti per aspirazione e lavaggio	79
A07	Titan-Clips und Anlegezangen Titanium clips and applying forceps Clips de titanio y pinzas para aplicar Clips en titane et pincers à poser Clip in titanio e pinze per applicare	85
A08	Wundhaken und Wundspreizer Retractors and self-retaining retractors Separadores y separadores autoestáticos Ecarteurs et écarteurs autostatiques Divaricatori e divaricatori autostatici	87
A09	Elevatoren und Raspatorien Elevators and raspatories Elevadores y legras Élévateurs et rugines Elevatori e periostotomi	99
A10	Hämmer, Stößel, Meißel und Löffel Mallets, pestles, chisels and curettes Martillos, pisón, cinceles y cucharillas Maillets, pilon, ciseaux burins et curettes Martelli, pestone, scalpelli e cucchiai	109
A11	Hohlmeißel- und Knochensplitterzangen Bone rongeurs and bone cutting forceps Pinzas-gubias y pinzas cortantes para huesos Pinces-gouges et pincers coupantes à os Pinze sgorbie e pinze ossivore	129

Skalpellsklingen und Skalpellsgriffe
Scalpel Blades and Scalpel Handles
Hojas de bisturí y mangos de bisturí
Lames de bistouris et manches pour bistouris
Lame per bisturi e manici per bisturi

A01



Verpackung für Skalpellsklingen
 Packing for scalpel blades
 Paquete para hojas de bisturí
 Emballage pour lames de bistouris
 Confezione per lame per bisturi



450.00.03

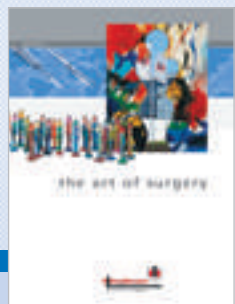

Unser komplettes Skalpells-Programm finden Sie in unserem Hauptkatalog.
 For our complete scalpel line, see our main catalogue.
 El programa completo de bisturís se encuentra en nuestro catálogo general.
 Vous trouverez notre gamme complète de bistouris dans notre catalogue général.
 Troverete il nostro programma completo di bisturi nel nostro catalogo generale.



Skalpellklingen und Skalpellgriffe
Scalpel Blades and Scalpel Handles
Hojas de bisturí y mangos de bisturí
Lames de bistouris et manches pour bistouris
Lame per bisturi e manici per bisturi

A01

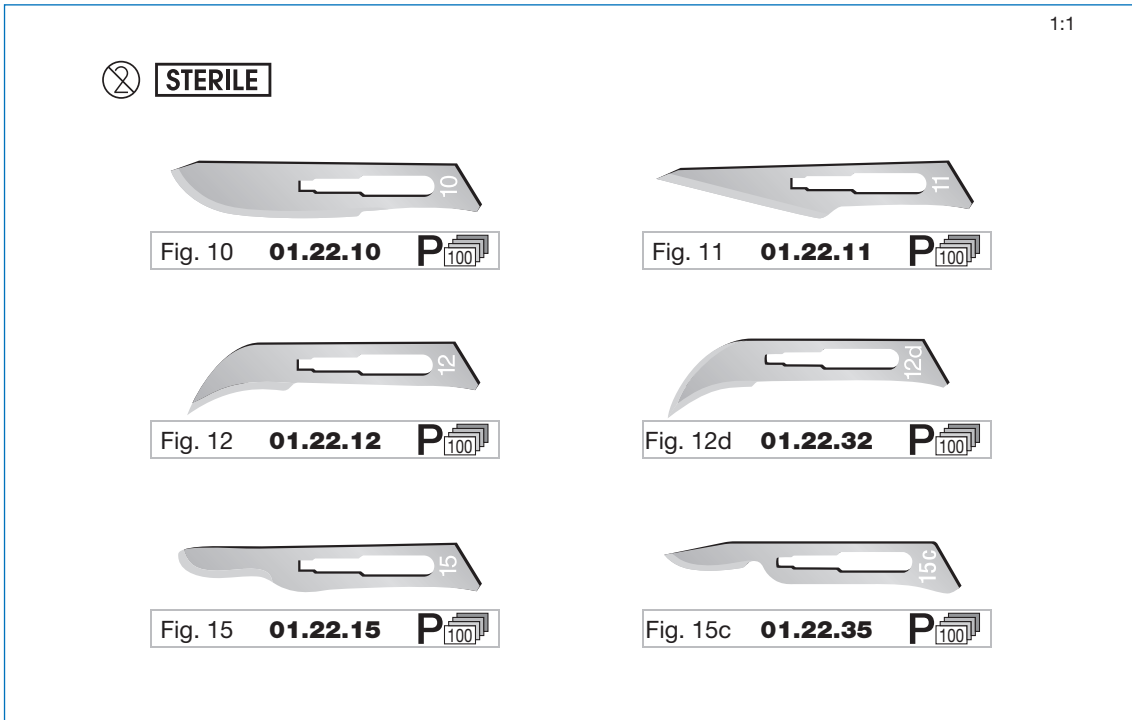

Einmalprodukt
 Single use product
 Prodotto para un solo uso
 Produit à usage unique
 Prodotto monouso

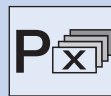

Verpackungseinheit "X" Stück
 Packing unit "X" pieces
 Paquete de "X" unidades
 Emballage de "X" pièces
 Confezione da "X" pezzi

Skalpellklingen und Skalpellgriffe
Scalpel Blades and Scalpel Handles
Hojas de bisturí y mangos de bisturí
Lames de bistouris et manches pour bistouris
Lame per bisturi e manici per bisturi

A01

1:1

STERILE





Fig. 20 **01.22.20** P 





Fig. 21 **01.22.21** P 







Fig. 25 **01.22.25** P 



13,5 cm – 5 $\frac{3}{8}$ " **01.28.04** no. 4



21 cm – 8 $\frac{1}{4}$ " **01.28.14** no. 4L



22,5 cm – 9" **01.28.45**

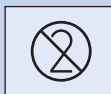

Einmalprodukt
 Single use product
 Prodotto para un solo uso
 Produit à usage unique
 Prodotto monouso

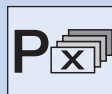

Verpackungseinheit "X" Stück
 Packing unit "X" pieces
 Paquete de "X" unidades
 Emballage de "X" pièces
 Confezione da "X" pezzi



Skalpellklingen und Skalpellgriffe
Scalpel Blades and Scalpel Handles
Hojas de bisturí y mangos de bisturí
Lames de bistouris et manches pour bistouris
Lame per bisturi e manici per bisturi

A01



1:1



Fig. 62 **01.30.62** P₁₂



Fig. 64 **01.30.64** P₁₂



Fig. 65 **01.30.65** P₁₂



Fig. 67 **01.30.67** P₁₂





Fig. 69 **01.30.69** P₁₂



STERILE

15,5 cm – 6 1/8" **01.30.36**

18 cm – 7 1/8" **01.30.37**

95 mm

21 cm – 8 1/4" **01.27.21** **Landolt**

140 mm

25 cm – 10" **01.27.25** **Landolt**



Einmalprodukt
 Single use product
 Producto para un solo uso
 Produit à usage unique
 Prodotto monouso

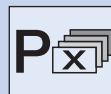

Verpackungseinheit "X" Stück
 Packing unit "X" pieces
 Paquete de "X" unidades
 Emballage de "X" pièces
 Confezione da "X" pezzi

Von "standard" bis "magic cut" – alle Scheren werden von fachkundigen Chirurgiemechanikern hergestellt. Sie werden für dauerhafte Leistung sorgfältig gehärtet und qualitätsgerecht geprüft.

Starting with "standard" up to "magic cut" – all scissors are manufactured by experienced professionals. They are thoroughly hardened to ensure a long-lasting performance and are quality-checked.

Desde tijeras "standard" hasta "magic cut" – todas las tijeras son fabricadas por expertos competentes. Las tijeras son templadas e investigadas respecto la calidad para un durable rendimiento.

De "standard" à "magic cut" – tous les ciseaux sont fabriqués par des mécaniciens de chirurgie compétents. Ils sont trempés soigneusement afin d'obtenir une performance durable et passent un contrôle de qualité.

Dalla "standard" alla "magic cut" – tutte le forbici sono prodotte da meccanici chirurgici specializzati. Per una lunga durata sono temprate accuratamente e devono passare il controllo di qualità.

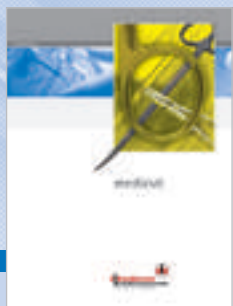
451.03.23

Unser komplettes Scheren-Programm finden Sie in unserem Sonderprospekt.
 For our complete line of scissors, see our special brochure.
 El programa completo de tijeras se encuentra en nuestro folleto especial.
 Vous trouverez notre gamme complète de ciseaux dans notre brochure spécial.
 Troverete il nostro programma completo di forbici nel nostro depliant speciale.

**A02**

Farbcodierung
Color Coding
Codificación de color
Codage de couleur
Codice colore

supercut

Goldene Schraube
 Golden screw
 Tornillo dorado
 Vis dorée
 Vite dorata

**black line**

Goldene Schraube und schwarze Ringgriffe
 Golden screw and black rings
 Tornillo dorado y anillos negros
 Vis dorée et anneaux noirs
 Vite dorata e anelli neri

**"HM"**

Goldene Ringgriffe
 Golden rings
 Anillos dorados
 Anneaux dorés
 Anelli dorati

**supercut plus**

Goldene Schraube und goldene Ringgriffe
 Golden screw and golden rings
 Tornillo dorado y anillos dorados
 Vis dorée et anneaux dorés
 Vite dorata e anelli dorati

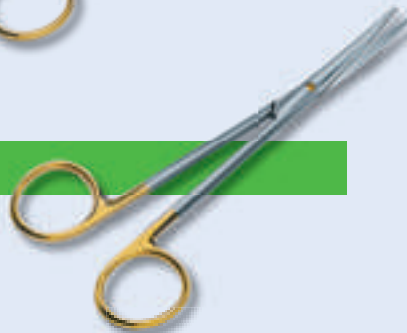
**magic cut**

Keramikbeschichtung und goldene Schraube
 Ceramic coating and golden screw
 Recubrimiento de cerámica y tornillo dorado
 Couche céramique et vis dorée
 Rivestimento di ceramica e vite dorata



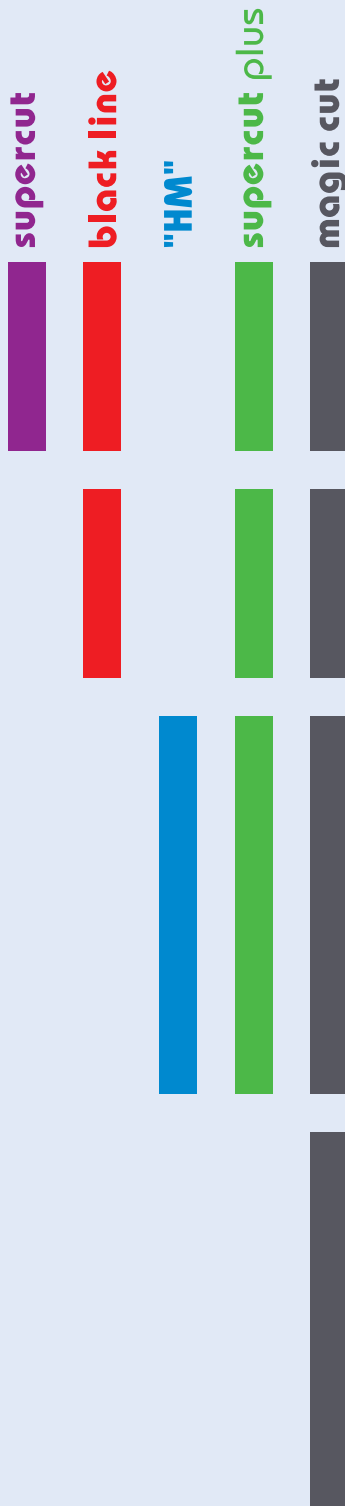

Messerschliff und Mikroverzahnung: Feiner, minimal traumatisierender Schnitt
Knife edges and micro serration: Fine, minimally traumatizing cut
Hoja de bisturí y dentadura micro: Corte fino, mínimo traumatizante
Aiguisement tranchant et dents micro: Coupe fine, peu traumatisante
Affilatura a scalpello e dentellatura micro: Taglio fine, minimamente traumatizzante

Zusätzlicher Anschlag einer Blattrückseite: Bessere Sicht · Präzise Präparation
Reduction of the transversal cut: Better visibility · Precise dissection
Reducción del corte transversal: Visión mejorada · Disección precisa
Coupe transversale réduite: Vue améliorée · Dissection précise
Riduzione del taglio trasversale: Vista migliorata · Dissezione precisa

Eingeschweißte Hartmetallschneiden: Nahtlose, homogene und korrosionsfreie Verbindung von Hartmetall und Scherenstahl
Welded tungsten carbide cutting edges: Seamless, homogenous and corrosion-free junction of tungsten carbide and scissors steel
Hojas soldadas de carburo de tungsteno: Unión sin costuras, homogénea y resistente a la corrosión del carburo de tungsteno con el acero
Lames soudées d'un alliage de carbure de tungstène: Jointure sans trace, homogène et résistante à la corrosion du carbure de tungstène avec l'acier des ciseaux
Lame saldate al carburo di tungsteno: Congiunzione senza saldature, omogenea e resistente alla corrosione del carburo di tungsteno e all'acciaio delle forbici

Keramikbeschichtung: Lange Standzeit · Hohe Oberflächenhärte · Blendfreie Oberfläche · Hervorragende Gleitfähigkeit
Ceramic coating: Long lasting cutting ability · High surface hardness · Non-dazzling surface · Excellent sliding capacity
Recubrimiento de cerámica: Máxima duración del corte · Alta dureza de la superficie · Superficie antideslumbrante · Deslizamiento destacado
Couche céramique: Longue durée de vie · Grande dureté de la surface · Surface non-éblouissante · Glissement excellent
Rivestimento di ceramica: Massima durata del taglio · Alta durezza della superficie · Superficie antiriflesso · Eccellente scorrimento

**A02**

Feine Schere und chirurgische Scheren
Delicate Scissors and Operating Scissors
Tijera fina y tijeras quirúrgicas
Ciseaux délicat et ciseaux chirurgicaux
Forbice delicata e forbici chirurgiche

Feine Schere
 Delicate scissors
 Tijera fina
 Ciseaux délicat
 Forbice delicata

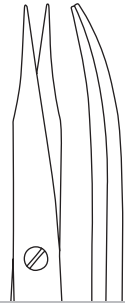

13 cm – 5 1/8"

02.50.45**standard**

Chirurgische Scheren
 Operating scissors
 Tijeras quirúrgicas
 Ciseaux chirurgicaux
 Forbici chirurgiche

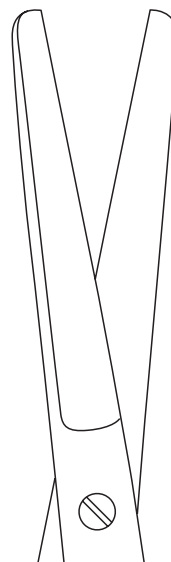
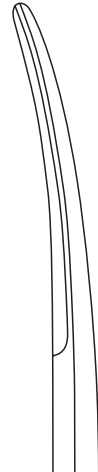
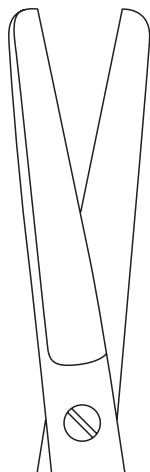

14,5 cm – 5 3/4"

14,5 cm – 5 3/4"

16,5 cm – 6 1/2"

16,5 cm – 6 1/2"

03.02.14**03.03.14****03.02.16****03.03.16****standard****203.02.14****203.03.14****203.02.16****203.03.16****supercut****213.02.14****213.03.14****black line****03.02.64****03.03.64****"HM"**



14,5 cm – 5¾"	14,5 cm – 5¾"	16,5 cm – 6½"	16,5 cm – 6½"	
03.06.14	03.07.14	03.06.16	03.07.16	standard
203.06.14	203.07.14	203.06.16		supercut
213.06.14	213.07.14			black line
03.06.64	03.07.64			"HM"



14,5 cm – 5¾"	14,5 cm – 5¾"	16,5 cm – 6½"	16,5 cm – 6½"	
03.04.14	03.05.14	03.04.16	03.05.16	standard
203.04.14	203.05.14			supercut
213.04.14	213.05.14			black line
03.04.64	03.05.64			"HM"



Chirurgische Scheren
Operating Scissors
Tijeras quirúrgicas
Ciseaux chirurgicaux
Forbici chirurgiche

A02



14,5 cm – 5¾"	14,5 cm – 5¾"	
03.04.84	03.05.84	standard



14,5 cm – 5¾"	14,5 cm – 5¾"	
03.06.84	03.07.84	standard



14,5 cm – 5¾"	14,5 cm – 5¾"	
03.02.84	03.03.84	standard



Mayo

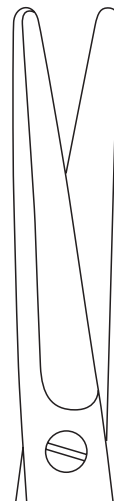
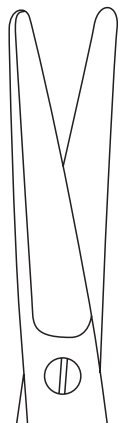

14,5 cm – 5¾"	14,5 cm – 5¾"	17 cm – 6¾"	17 cm – 6¾"	
03.50.14	03.51.14	03.50.17	03.51.17	standard
203.50.14	203.51.14	203.50.17	203.51.17	supercut
213.50.14	213.51.14	213.50.17	213.51.17	black line
03.50.64	03.51.64	03.50.67	03.51.67	"HM"
203.50.64	203.51.64	203.50.67	203.51.67	supercut plus

**A02**

Feine Präparierscheren
Delicate Dissecting Scissors
Tijeras finas para disección
Ciseaux délicats pour dissection
Forbici delicate per dissezione

21
8
20
19
18
7
17
16
6
15
14
5
13
12
11
4
10
9
3
8
7
6
2
5
4
3
1
2
1
cm | inch

**Greenberg PAR**

11,5 cm – 4½"	
204.13.62	supercut plus
224.13.62	magic cut

**Shea**

12 cm – 4¾"	
04.13.12	standard
204.13.12	supercut
214.13.12	black line

Feine Präparierscheren
Delicate Dissecting Scissors
Tijeras finas para disección
Ciseaux délicats pour dissection
Forbici delicate per dissezione

A02



"slim"

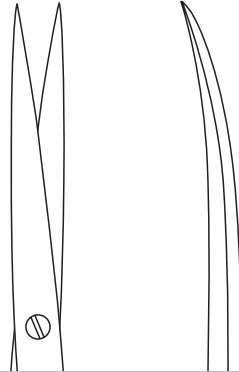

14 cm – 5½"	14 cm – 5½"	
04.24.14	04.25.14	standard
204.24.14	204.25.14	supercut
04.24.64	04.25.64	"HM"
204.24.64	204.25.64	supercut plus



Baby-Metzenbaum

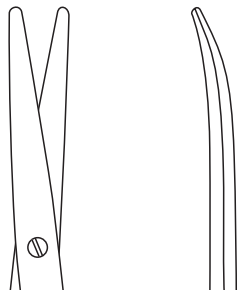

11,5 cm – 4½"	11,5 cm – 4½"	
04.32.11	04.33.11	standard
204.32.11	204.33.11	supercut
214.32.11	214.33.11	black line
04.32.61	04.33.61	"HM"
204.32.61	204.33.61	supercut plus

**A02**

Präparierscheren
Dissecting Scissors
Tijeras para disección
Ciseaux pour dissection
Forbici per dissezione

21
8
20
19
7
18
17
6
16
15
14
5
13
12
4
11
10
3
9
8
7
6
5
2
4
3
1
2
1
cm inch

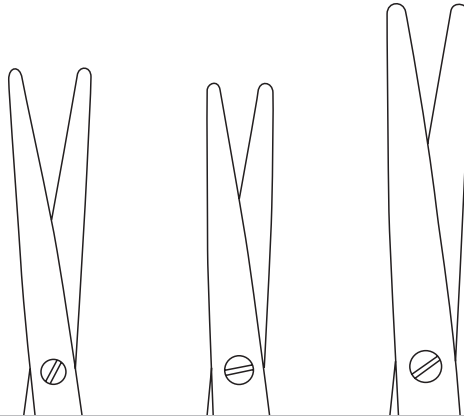
**Metzenbaum**

14 cm – 5½"	18 cm – 7⅛"	20 cm – 8"	
04.32.14	04.32.18	04.32.20	standard
204.32.14	204.32.18	204.32.20	supercut
214.32.14	214.32.18	214.32.20	black line
04.32.64	04.32.68	04.32.70	"HM"
204.32.64	204.32.68	204.32.70	supercut plus

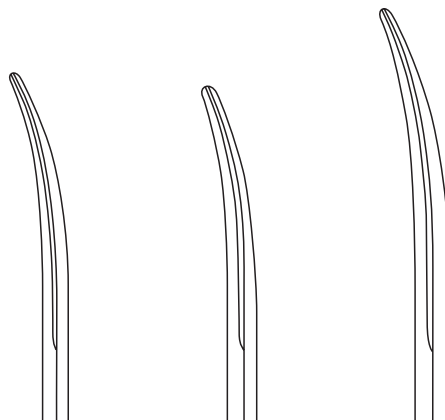
**Metzenbaum**

14 cm – 5½"	18 cm – 7⅛"	20 cm – 8"	
04.33.14	04.33.18	04.33.20	standard
204.33.14	204.33.18	204.33.20	supercut
214.33.14	214.33.18	214.33.20	black line
04.33.64	04.33.68	04.33.70	"HM"
204.33.64	204.33.68	204.33.70	supercut plus

**Präparierscheren
Dissecting Scissors
Tijeras para disección
Ciseaux pour dissection
Forbici per dissezione**

A02



Metzenbaum-slim

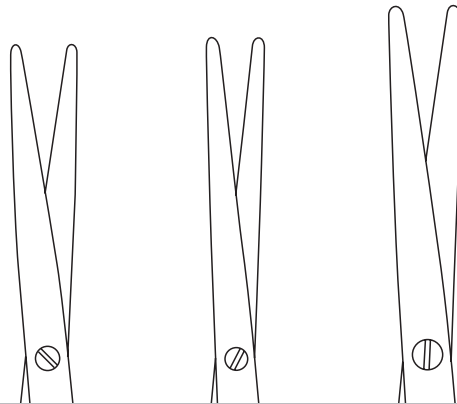

14 cm – 5½"	18 cm – 7⅛"	20 cm – 8"	
04.34.14	04.34.18	04.34.20	standard
204.34.14	204.34.18	204.34.20	supercut
214.34.14	214.34.18	214.34.20	black line
04.34.64	04.34.68	04.34.70	"HM"
204.34.64	204.34.68	204.34.70	supercut plus



Metzenbaum-slim

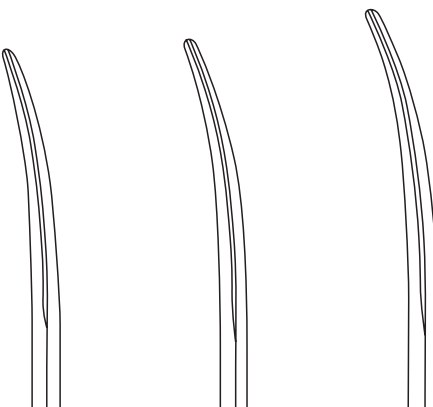

14 cm – 5½"	18 cm – 7⅛"	20 cm – 8"	
04.35.14	04.35.18	04.35.20	standard
204.35.14	204.35.18	204.35.20	supercut
214.35.14	214.35.18	214.35.20	black line
04.35.64	04.35.68	04.35.70	"HM"
204.35.64	204.35.68	204.35.70	supercut plus

**A02**

Präparierscheren
Dissecting Scissors
Tijeras para disección
Ciseaux pour dissection
Forbici per dissezione

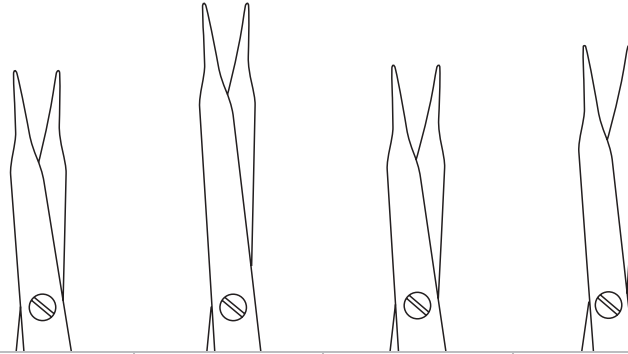
**Reynolds (Jameson)**

12 cm – 4¾"	14 cm – 5½"	16 cm – 6¼"	18 cm – 7⅛"	
04.66.12	04.66.14	04.66.16	04.66.18	standard

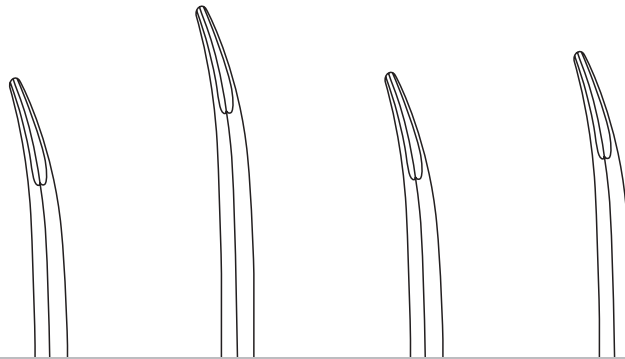
**Reynolds (Jameson)**

12 cm – 4¾"	14 cm – 5½"	16 cm – 6¼"	18 cm – 7⅛"	
04.67.12	04.67.14	04.67.16	04.67.18	standard
204.67.12		204.67.16	204.67.18	supercut
214.67.12		214.67.16	214.67.18	black line
		224.67.66	224.67.68	magic cut

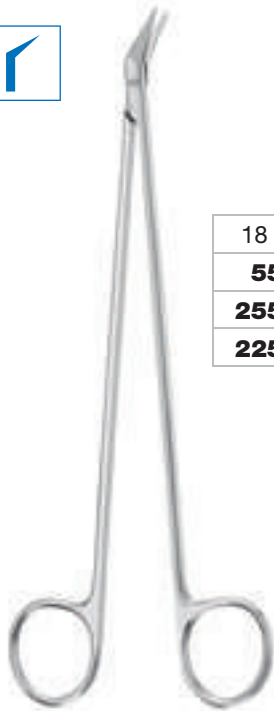

Hegemann-Diethrich



25°

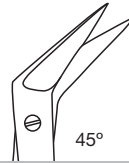

45°

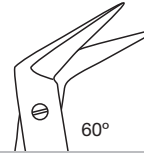

60°

18 cm – 7 1/8"	18 cm – 7 1/8"	18 cm – 7 1/8"	
55.15.32	55.15.34	55.15.36	standard
255.15.32	255.15.34	255.15.36	supercut
225.15.32	225.15.34	225.15.36	magic cut



Potts-Smith

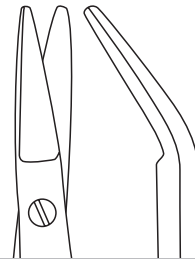
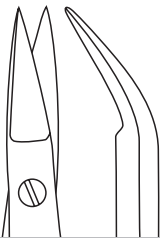

19 cm – 7 1/2"	19 cm – 7 1/2"	
55.15.50	55.15.51	standard



seitwärts gewinkelt
 angled to side
 acodadas lateralmente
 coudés latéralement
 angolata lateralmente



Gefäßscheren und Mikro-Scheren
Vascular Scissors and Micro Scissors
Tijeras vasculares y micro tijeras
Ciseaux vasculaires et micro ciseaux
Forbici vascolari e micro forbici

A02

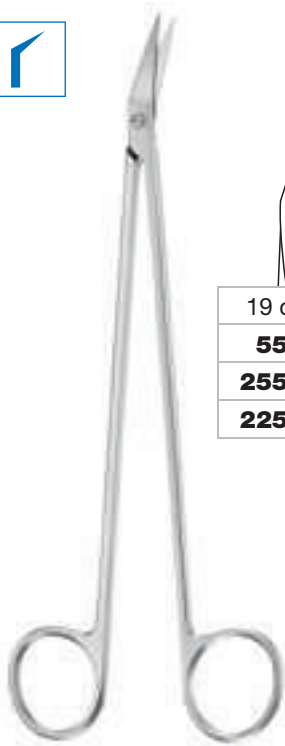

Potts-Smith



25°

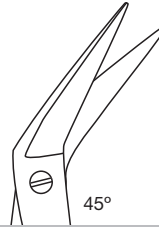

45°

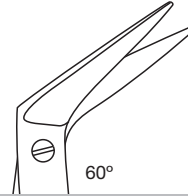

60°

19 cm - 7½"	19 cm - 7½"	19 cm - 7½"	
55.15.42	55.15.44	55.15.46	standard
255.15.42	255.15.44	255.15.46	supercut
225.15.42	225.15.44	225.15.46	magic cut

VANNAS



8 mm



15 cm - 6"

05.15.74**205.15.74**

15 cm - 6"

05.15.75

15 cm - 6"

05.15.76

15 cm - 6"

05.15.77

15 cm - 6"	15 cm - 6"	15 cm - 6"	15 cm - 6"	
05.15.74	05.15.75	05.15.76	05.15.77	standard
205.15.74				supercut



Rundgriff
 Round handle
 Mango redondo
 Manche rond
 Manico rotondo



seitwärts gewinkelt
 angled to side
 acodadas lateralmente
 coudés latéralement
 angolata lateralmente



Vannas-Schneiden
 Vannas-type cutting edges
 Hojas según Vannas
 Lames selon Vannas
 Lame secondo Vannas



micro 2000

15 cm – 6"	15 cm – 6"	18 cm – 7 1/8"	18 cm – 7 1/8"	
05.15.70	05.15.71	05.18.70	05.18.71	standard
		205.18.70	205.18.71	supercut



15 cm – 6"	15 cm – 6"	18 cm – 7 1/8"	18 cm – 7 1/8"	
05.15.72	05.15.73	05.18.72	05.18.73	standard



15 cm – 6"	15 cm – 6"	18 cm – 7 1/8"	18 cm – 7 1/8"	
05.15.81	05.15.83	05.18.81	05.18.83	standard



Instrumente mit blau eloxierten Leichtmetall-Griffen für höchste Präzision und Arbeitskomfort.

Instruments with blue anodized light metal handles for maximum precision and working convenience.

Instrumentos con mangos de metal ligero anodizados en azul para la precisión y el confort de trabajo máximo.

Instruments avec manches en métal léger anodisés en bleu pour un maximum de précision et de confort à l'utilisation.

Strumenti con manici di metallo leggero anodizzati blu per una precisione massima e conforto lavorativo.



Eine Schneide gezahnt
 One blade serrated
 Una hoja dentada
 Une lame dentelée
 Una lama dentellata



spitz
 sharp
 aguda
 pointu
 acuta



stumpf
 blunt
 roma
 mousse
 smussa



Mikro-Scheren
Micro Scissors
Micro tijeras
Micro ciseaux
Micro forbici

A02

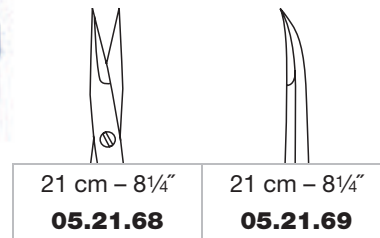
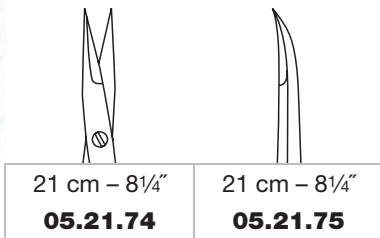
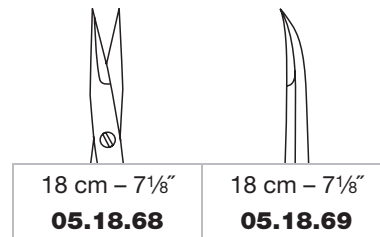
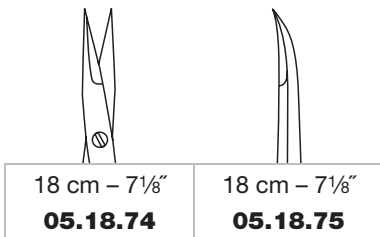
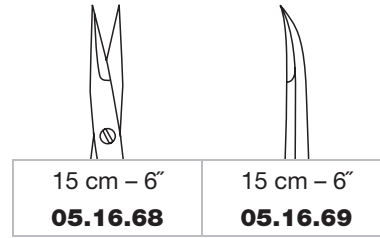
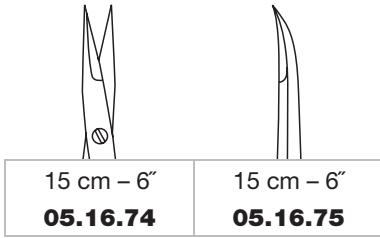

Tumorscheren
Tumor scissors
Tijeras para tumores
Ciseaux pour tumeur
Forbici per tumori

— a —

gerade straight recta droit retta	rechts gebogen curved right curva derecha courbé à droite curva a destra	links gebogen curved left curva izquierda courbé à gauche curva a sinistra
8 mm	8 mm	8 mm
a = 12,5 cm - 5"	a = 12,5 cm - 5"	a = 12,5 cm - 5"
58.46.40	58.46.42	58.46.43

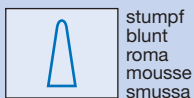
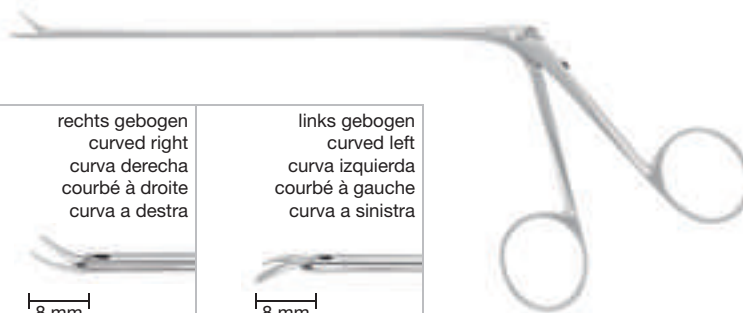

stumpf
blunt
roma
mousse
smussa



Rundgriff
Round handle
Mango redondo
Manche rond
Manico rotondo



Titan
Titanium
Titanio
Titane
Titanio

VANNAS



12 cm – 4¾"	12 cm – 4¾"	12 cm – 4¾"	12 cm – 4¾"	12 cm – 4¾"
05.18.84	05.18.85	05.18.86	05.18.87	05.18.89

VANNAS



16 cm – 6¼"	16 cm – 6¼"	16 cm – 6¼"	16 cm – 6¼"
05.18.92	05.18.93	05.18.94	05.18.95



13 cm – 5¼"
05.18.90

Biemer



spitz
sharp
aguda
pointu
acuta



Vannas-Schneiden
Vannas-type cutting edges
Hojas según Vannas
Lames selon Vannas
Lame secondo Vannas



Mikro-Scheren
Micro Scissors
Micro tijeras
Micro ciseaux
Micro forbici

A02



Millesi



16 cm – 6 1/4"
05.18.96



16 cm – 6 1/4"
05.18.97



Yasargil



18,5 cm – 7 1/4"
05.18.98



Jacobson



18,5 cm – 7 1/4"
05.18.99



Potts-Yasargil

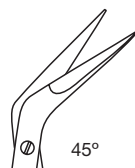

18,5 cm – 7 1/4"
05.19.01



seitwärts gewinkelt
angled to side
acodadas lateralmente
coudés latéralement
angolata lateralmente



Eine Schneide gezahnt
One blade serrated
Una hoja dentada
Une lame dentelée
Una lama dentellata



spitz
sharp
aguda
pointu
acuta

Mikro-Scheren
Micro Scissors
Micro tijeras
Micro ciseaux
Micro forbici

A02



23 cm - 9"
05.19.02



8 mm



18,5 cm - 7¼"
05.19.10



25°



45°

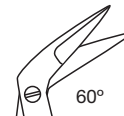

60°

18 cm - 7⅞"	18 cm - 7⅞"	18 cm - 7⅞"	
05.19.25	05.19.45	05.19.60	"HM"
225.19.25	225.19.45	225.19.60	magic cut



seitwärts gewinkelt
 angled to side
 acodadas lateralmente
 coudés latéralement
 angolata lateralmente



spitz
 sharp
 aguda
 pointu
 acuta



stumpf
 blunt
 roma
 mousse
 smussa

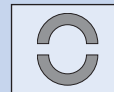

Rundgriff
 Round handle
 Mango redondo
 Manche rond
 Manico rotondo



Mikro-Scheren
Micro Scissors
Micro tijeras
Micro ciseaux
Micro forbici

A02



Yasargil



Instrumente mit blau eloxierten Leichtmetall-Griffen für höchste Präzision und Arbeitskomfort.

Instruments with blue anodized light metal handles for maximum precision and working convenience.

Instrumentos con mangos de metal ligero anodizados en azul para la precisión y el confort de trabajo máximo.

Instruments avec manches en métal léger anodisés en bleu pour un maximum de précision et de confort à l'utilisation.

Strumenti con manici di metallo leggero anodizzati blu per una precisione massima e conforto lavorativo.

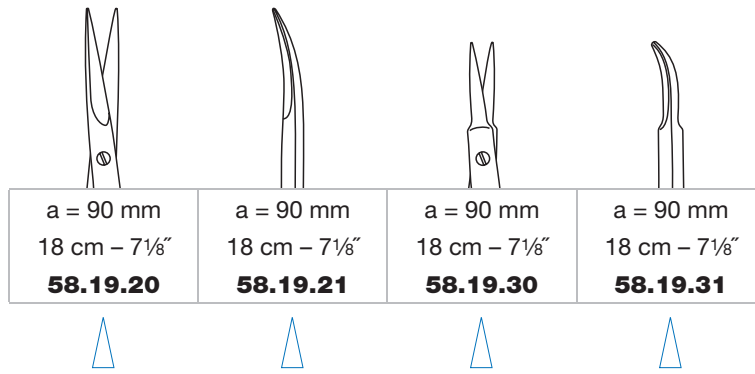

a = 90 mm 18 cm - 7 1/8"	a = 90 mm 18 cm - 7 1/8"	a = 90 mm 18 cm - 7 1/8"	a = 90 mm 18 cm - 7 1/8"
58.19.20	58.19.21	58.19.30	58.19.31



micro 2000

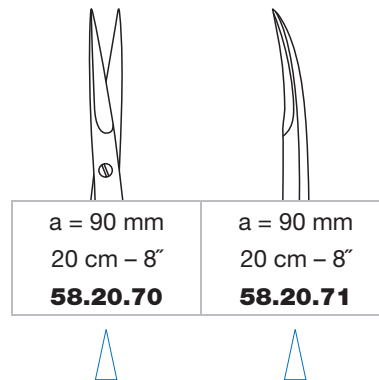



a = 90 mm 20 cm - 8"	a = 90 mm 20 cm - 8"
58.20.70	58.20.71



spitz
sharp
aguda
pointu
acuta





Yasargil



	
a = 55 mm 16 cm - 6 1/4"	a = 55 mm 16 cm - 6 1/4"
59.16.20	59.16.21



Yasargil

		
a = 85 mm 20 cm - 8"	a = 85 mm 20 cm - 8"	a = 85 mm 20 cm - 8"
59.20.20	59.20.21	59.20.23



	
a = 85 mm 20 cm - 8"	a = 85 mm 20 cm - 8"
59.20.30	59.20.31

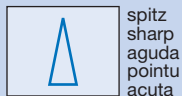

spitz
sharp
aguda
pointu
acuta



stumpf
blunt
roma
mousse
smussa



Mikro-Scheren
Micro Scissors
Micro tijeras
Micro ciseaux
Micro forbici

A02

VANNAS



Yasargil

a



a = 105 mm
23 cm - 9"
59.23.20



a = 105 mm
23 cm - 9"
59.23.21



a = 105 mm
23 cm - 9"
59.23.30



a = 105 mm
23 cm - 9"
59.23.31



Yasargil

a



a = 105 mm
23 cm - 9"
59.23.40



a = 105 mm
23 cm - 9"
59.23.41



spitz
sharp
aguda
pointu
acuta



stumpf
blunt
roma
mousse
smussa



Vannas-Schneiden
Vannas-type cutting edges
Hojas según Vannas
Lames selon Vannas
Lame secondo Vannas

Ligaturscheren
Ligature Scissors
Tijeras para ligaduras
Ciseaux à ligature
Forbici per legature

A02

Ligaturscheren
 Ligature scissors
 Tijeras para ligaduras
 Ciseaux à ligature
 Forbici per legature

mit Mikroverzahnung und Hartmetallschneiden
 with micro serration and tungsten carbide edges
 con micro dientes y hojas de carburo tungsteno
 avec denture micro et lames en carbure tungstène
 con dentellatura micro e lame in carburo di tungsteno

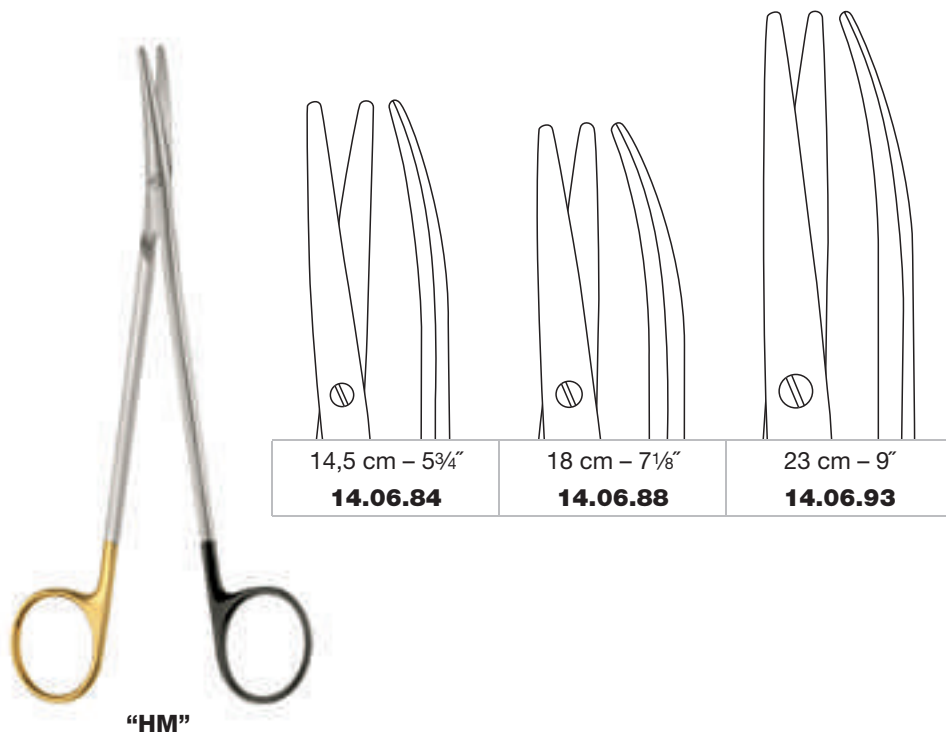



A02

Draht- und Mesh-Plattenscheren
Wire and Mesh Plate Cutting Scissors
Tijeras para cortar alambre y placas Mesh
Ciseaux coupe-fil et coupe-plaques Mesh
Forbici per fili d'acciaio e placche Mesh



Draht- und Mesh-Plattenscheren
 Wire and Mesh plate cutting scissors
 Tijeras para cortar alambre y placas Mesh
 Ciseaux coupe-fil et coupe-plaques Mesh
 Forbici per fili d'acciaio e placche Mesh



Universal

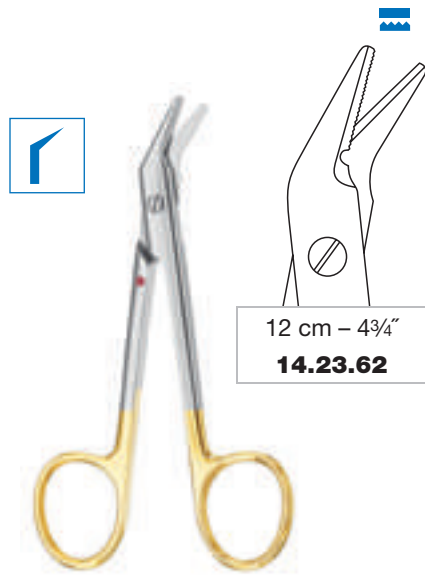

Universal "HM"

- max. Ø 0,3 mm Harte Drähte
Hard wires
Alambres duros
Fils durs
Fili duri
- max. Ø 0,8 mm Weiche Drähte
Soft wires
Alambres blandos
Fils mous
Fili dolci

"HM"
 Hartmetall
 Tungsten carbide
 Carburo de tungsteno
 Carbure de tungstène
 Carburo di tungsteno

 seitwärts gewinkelt
 angled to side
 acodadas lateralmente
 coudés latéralement
 angolata lateralmente

 Eine Schneide gezahnt
 One blade serrated
 Una hoja dentada
 Une lame dentelée
 Una lama dentellata

Pinzetten
Forceps
Pinzas
Pinces
Pinze

A03

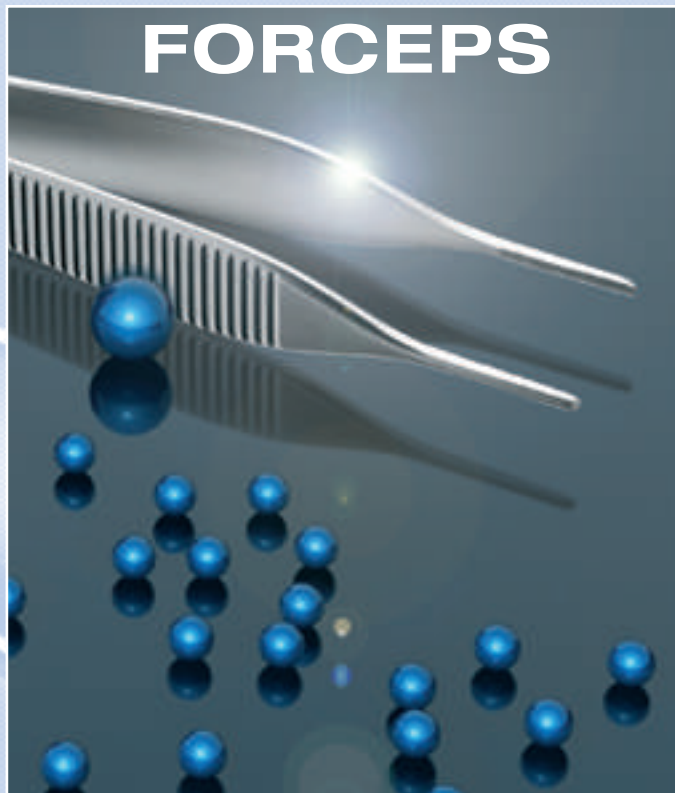



A03

Feine Pinzetten, anatomisch und chirurgisch
Delicate Forceps, dressing and tissue
Pinzas finas, anatómicas y quirúrgicas
Pinces délicates, anatomiques et chirurgicales
Pinze delicate, anatomiche e chirurgiche



Adson

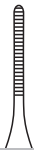

12 cm – 4¾"
06.20.12



Adson



12 cm – 4¾"
06.21.12



12 cm – 4¾"
06.21.13



Adson "HM"



12 cm – 4¾"
06.20.62



12 cm – 4¾"
06.21.62



Adson "HM"



15 cm – 6"
06.20.65



15 cm – 6"
06.21.65



Micro-Adson



12 cm – 4¾"
06.22.12



12 cm – 4¾"
06.23.12



Micro-Adson



15 cm – 6"
06.22.15



15 cm – 6"
06.23.15

"HM"

Hartmetall
 Tungsten carbide
 Carburo de tungsteno
 Carbure de tungstène
 Carburo di tungsteno





Vergrößerung
 Magnification
 Engrandecimiento
 Agrandissement
 Ingrandimento

Feine Pinzetten, anatomisch und chirurgisch
Delicate Forceps, dressing and tissue
Pinzas finas, anatómicas y quirúrgicas
Pinces délicates, anatomiques et chirurgicales
Pinze delicate, anatomiche e chirurgiche

A03





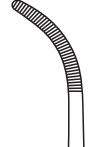

Semken

	
12,5 cm – 5" 06.30.12	12,5 cm – 5" 06.30.22
	
15 cm – 6" 06.30.15	15 cm – 6" 06.30.25





Semken

	
12,5 cm – 5" 06.31.12	12,5 cm – 5" 06.31.22
	
15 cm – 6" 06.31.15	15 cm – 6" 06.31.25







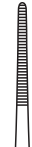

Semken

12,5 cm – 5" 06.31.32



"Select"

		
15 cm – 6" 06.34.55	18 cm – 7 1/8" 06.34.58	20 cm – 8" 06.34.60
		
15 cm – 6" 06.35.55	18 cm – 7 1/8" 06.35.58	20 cm – 8" 06.35.60



Anatomische und chirurgische Pinzetten
Dressing and Tissue Forceps
Pinzas anatómicas y quirúrgicas
Pincas anatomiques et chirurgicales
Pinze anatomiche e chirurgiche

A03



McIndoe



15 cm - 6"
06.40.15



Gillies



15 cm - 6"
06.40.85



Potts-Smith



18 cm - 7 1/8"
06.46.18



21 cm - 8 1/4"
06.46.20



25 cm - 10"
06.46.25



18 cm - 7 1/8"
06.48.18



21 cm - 8 1/4"
06.48.20



25 cm - 10"
06.48.25

Anatomische und chirurgische Pinzetten
 Dressing and Tissue Forceps
 Pinzas anatómicas y quirúrgicas
 Pincas anatomiques et chirurgicales
 Pinze anatomiche e chirurgiche

A03

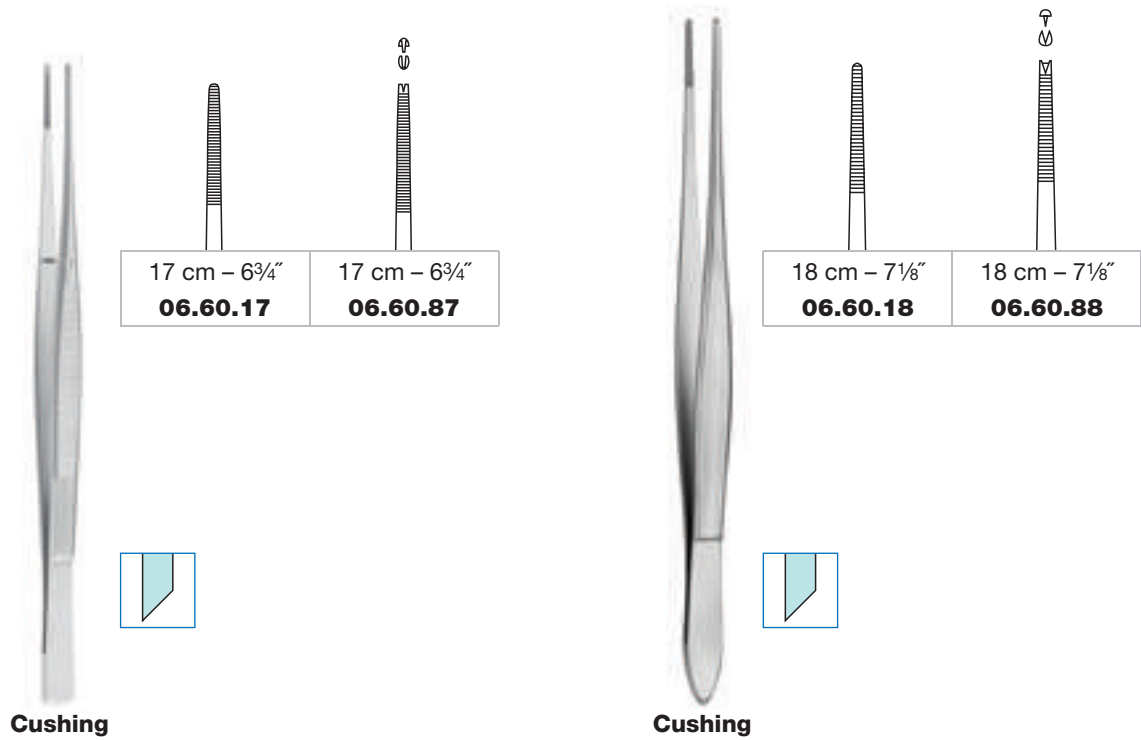

Cushing

Cushing

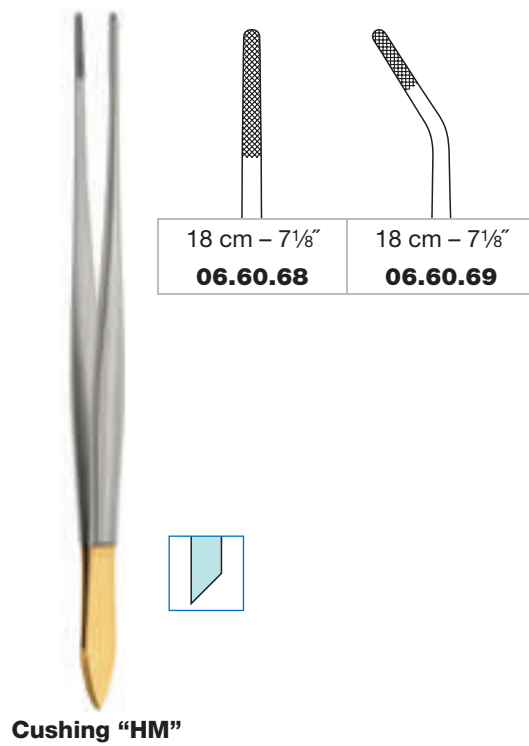

Cushing "HM"

"HM"
 Hartmetall
 Tungsten carbide
 Carburo de tungsteno
 Carbure de tungstène
 Carburo di tungsteno



mit Dissektorende
 with dissector end
 con extremo sirviendo de legra
 avec extrémité dissecteur
 con la parte finale a forma di dissettore



Atraumatische Gefäßpinzetten
Atraumatic Vascular Forceps
Pinzas vasculares atraumáticas
Pinces vasculaires atraumatiques
Pinze vascolari atraumatiche

A03



DeBakey "AT"



1,5 mm

1,5 mm

1,5 mm

1,5 mm

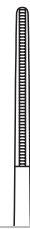
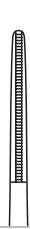
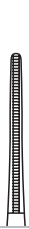

15 cm – 6"
06.50.15

20 cm – 8"
06.50.19

24 cm – 9½"
06.50.24

30 cm – 11¾"
06.50.30

2,0 mm

2,0 mm

2,0 mm

2,0 mm

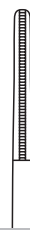
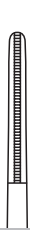
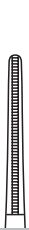

15 cm – 6"
06.52.15

20 cm – 8"
06.52.19

24 cm – 9½"
06.52.24

30 cm – 11¾"
06.52.30

2,8 mm

2,8 mm

2,8 mm

2,8 mm

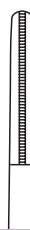

15 cm – 6"
06.54.15

20 cm – 8"
06.54.19

24 cm – 9½"
06.54.24

30 cm – 11¾"
06.54.30

3,5 mm

3,5 mm

3,5 mm

3,5 mm

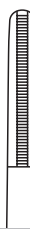
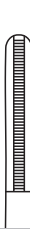
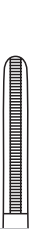

15 cm – 6"
06.55.15

20 cm – 8"
06.55.19

24 cm – 9½"
06.55.24

30 cm – 11¾"
06.55.30

DeBakey "AT"



"AT"
 Atraumatische Riefung
 Atraumatic serration
 Estrías atraumáticas
 Striure atraumatique
 Zigrinatura atraumatica

Atraumatische Gefäßpinzetten
Atraumatic Vascular Forceps
Pinzas vasculares atraumáticas
Pinces vasculaires atraumatiques
Pinze vascolari atraumatiche

A03

DeBakey "AT"

2,4 mm	2,4 mm	2,4 mm
15 cm – 6" 06.62.15	20 cm – 8" 06.62.19	24 cm – 9½" 06.62.24
2,8 mm	2,8 mm	2,8 mm
15 cm – 6" 06.64.15	20 cm – 8" 06.64.19	24 cm – 9½" 06.64.24

Atraumatische Gefäßpinzetten
 Atraumatic vascular forceps
 Pinzas vasculares atraumáticas
 Pinces vasculaires atraumatiques
 Pinze vascolari atraumatiche

extrem leicht
 extremely light
 especialmente ligera
 extrêmement légère
 estremamente leggera

DeBakey "AT"

1,2 mm	1,5 mm
15 cm – 6" 06.51.15	20 cm – 8" 06.51.20

"AT"

 Atraumatische Riefung
 Atraumatic serration
 Estrias atraumáticas
 Striure atraumatique
 Zigrinatura atraumatica



Atraumatische Pinzetten
Atraumatic Forceps
Pinzas atraumáticas
Pinces atraumatiques
Pinze atraumatiche

A03



DeBakey "AT"

1,0 mm

1,0 mm

1,0 mm



15 cm – 6"
06.70.15

20 cm – 8"
06.70.20

24 cm – 9½"
06.70.24

1,5 mm

1,5 mm

1,5 mm



15 cm – 6"
06.72.15

20 cm – 8"
06.72.20

24 cm – 9½"
06.72.24

2,0 mm

2,0 mm

2,0 mm



15 cm – 6"
06.74.15

20 cm – 8"
06.74.20

24 cm – 9½"
06.74.24

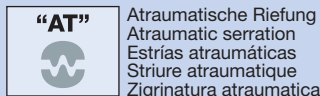

Atraumatische Pinzetten und Mikro-Pinzetten
Atraumatic Forceps and Micro Forceps
Pinzas atraumáticas y micro pinzas
Pinces atraumatiques et micro pinces
Pinze atraumatiche e micro pinze

A03



DeBakey "AT"

1,2 mm	1,2 mm	1,2 mm
15 cm – 6" 06.90.15	18 cm – 7 1/8" 06.90.18	21 cm – 8 1/4" 06.90.21
1,8 mm	1,8 mm	1,8 mm
15 cm – 6" 06.92.15	18 cm – 7 1/8" 06.92.18	21 cm – 8 1/4" 06.92.21

Juwelierpinzetten
 Jeweler's forceps
 Pinzas para joyero/relojero
 Pinces pour joaillier/horloger
 Pinze per gioielliere/orologiaio



11,5 cm – 4 1/2" 07.60.03	11,5 cm – 4 1/2" 07.60.04	11,5 cm – 4 1/2" 07.60.05	11,5 cm – 4 1/2" 07.60.07
no. 3	no. 4	no. 5	no. 7

"AT"

 Atraumatische Riefung
 Atraumatic serration
 Estrias atraumáticas
 Striure atraumatique
 Zigrinatura atraumatica

Ti
 Titan
 Titanium
 Titano
 Titane
 Titanio

spitz
 sharp
 aguda
 pointu
 acuta



Mikro-Pinzetten
Micro Forceps
Micro pinzas
Micro pinces
Micro pinze

A03

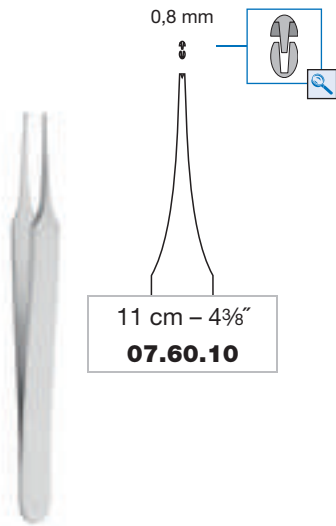

11 cm - 4 3/8"
07.60.10

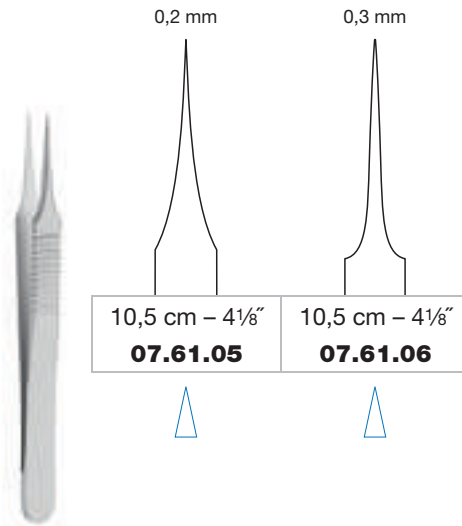

10,5 cm - 4 1/8" **07.61.05**
10,5 cm - 4 1/8" **07.61.06**

micro 2000

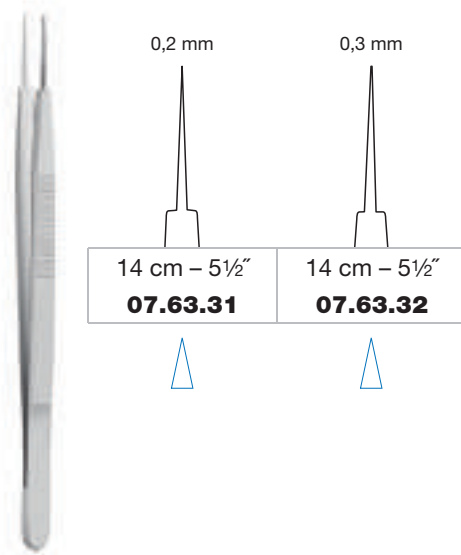

14 cm - 5 1/2" **07.63.31**
14 cm - 5 1/2" **07.63.32**

micro 2000

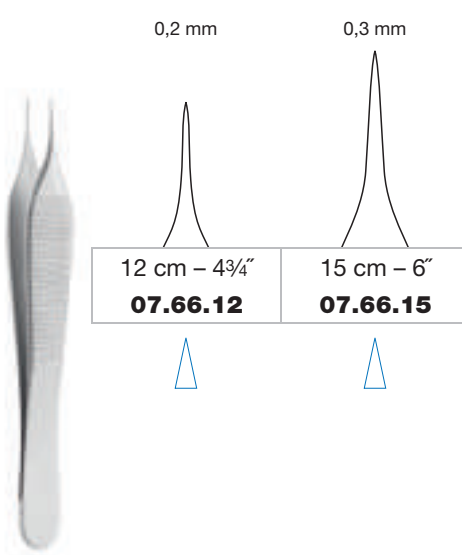

12 cm - 4 3/4" **07.66.12**
15 cm - 6" **07.66.15**

Jacobson-Adson



Vergrößerung
Magnification
Engrandecimiento
Agrandissement
Ingrandimento



spitz
sharp
aguda
pointu
acuta



stumpf
blunt
roma
mousse
smussa

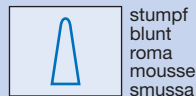
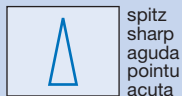
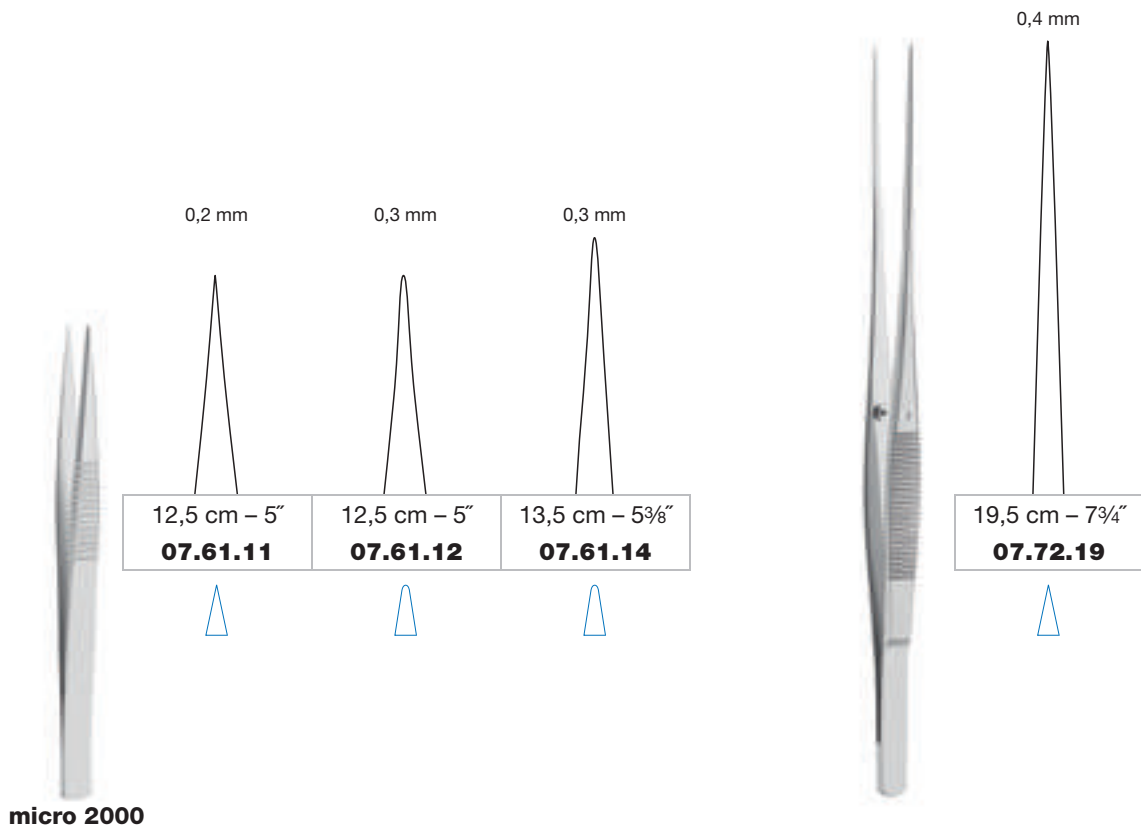
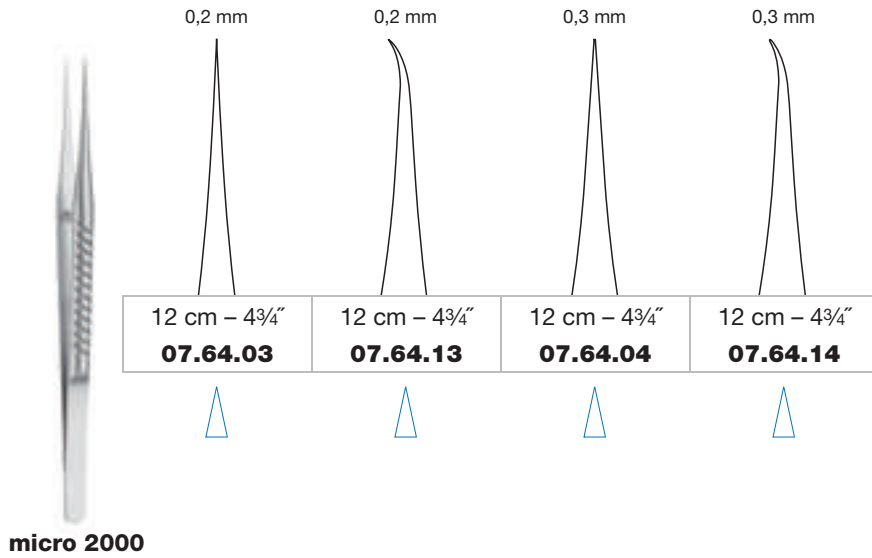







Mikro-Pinzetten
Micro Forceps
Micro pinzas
Micro pinces
Micro pinze

A03



micro 2000

0,2 mm	0,2 mm	0,3 mm	0,3 mm
15 cm - 6"	15 cm - 6"	15 cm - 6"	15 cm - 6"
07.64.63	07.64.73	07.64.64	07.64.74
			



Instrumente mit blau eloxierten Leichtmetall-Griffen für höchste Präzision und Arbeitskomfort.

Instruments with blue anodized light metal handles for maximum precision and working convenience.





Instrumentos con mangos de metal ligero anodizados en azul para la precisión y el confort de trabajo máximo.

Instruments avec manches en métal léger anodisés en bleu pour un maximum de précision et de confort à l'utilisation.

Strumenti con manici di metallo leggero anodizzati blu per una precisione massima e conforto lavorativo.



micro 2000

0,3 mm	0,3 mm	0,4 mm	0,4 mm
18 cm - 7 1/8"	18 cm - 7 1/8"	18 cm - 7 1/8"	18 cm - 7 1/8"
07.64.83	07.64.93	07.64.84	07.64.94
			



spitz
sharp
aguda
pointu
acuta



stumpf
blunt
roma
mousse
smussa

0,4 mm	0,4 mm	0,5 mm
11 cm – 4 $\frac{3}{8}$ "	15 cm – 6"	18 cm – 7 $\frac{1}{8}$ "
07.70.11	07.70.15	07.70.18

Jacobson

0,8 mm	1,2 mm	1,0 mm
16,5 cm – 6 $\frac{1}{2}$ "	16,5 cm – 6 $\frac{1}{2}$ "	19 cm – 7 $\frac{1}{2}$ "
07.75.30	07.75.31	07.75.32

spitz
 sharp
 aguda
 pointu
 acuta



Mikro-Pinzetten
Micro Forceps
Micro pinzas
Micro pinces
Micro pinze

A03



Ti

8 mm



0,4 mm

0,4 mm

0,4 mm

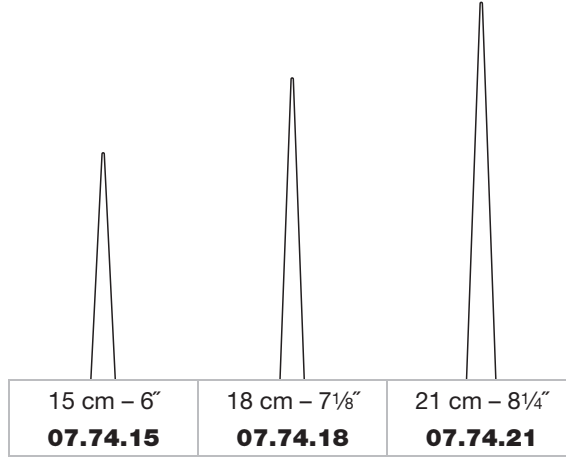

0,8 mm

0,8 mm

0,8 mm

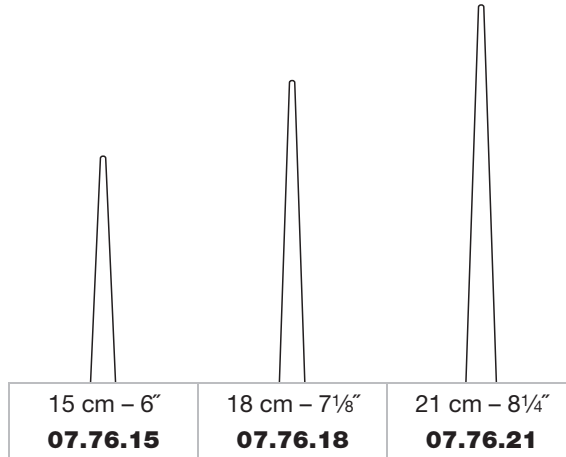

spitz
sharp
aguda
pointu
acuta



stumpf
blunt
roma
mousse
smussa



Titan
Titanium
Titanio
Titane
Titano



Rundgriff
Round handle
Mango redondo
Manche rond
Manico rotondo

Mikro-Pinzetten
Micro Forceps
Micro pinzas
Micro pincers
Micro pinze

A03



Dennis

mit Gewicht
 with weight
 con peso
 avec poids
 con peso

Ø 1,0 mm



18,5 cm – 7¼"
59.19.10

Ø 1,0 mm



18,5 cm – 7¼"
59.19.11

Ø 1,0 mm



21 cm – 8¼"
59.19.12

Ø 1,0 mm



21 cm – 8¼"
59.19.13



Ø 1,0 mm



18 cm – 7⅛"
59.19.14

Ø 1,0 mm



21 cm – 8¼"
59.19.15

Ø 1,0 mm



21 cm – 8¼"
59.19.16



0,4 mm



18 cm – 7⅛"
59.19.17

0,4 mm



21 cm – 8¼"
59.19.18

0,4 mm



21 cm – 8¼"
59.19.19



Rundgriff
 Round handle
 Mango redondo
 Manche rond
 Manico rotondo



Beschichtung mit Diamantstaub
 Coating with diamond dust
 Recubierto con polvo de diamante
 Revêtement avec de poussière de diamant
 Rivestito con polvere di diamante



Vergrößerung
 Magnification
 Engrandecimiento
 Agrandissement
 Ingrandimento



Mikro-Pinzetten
Micro Forceps
Micro pinzas
Micro pinces
Micro pinze

A03



Ø 1,0 mm

Ø 1,0 mm

Ø 1,0 mm



15 cm – 6"
59.45.15

18 cm – 7 1/8"
59.45.18

21 cm – 8 1/4"
59.45.21

Ø 2,0 mm

Ø 2,0 mm

Ø 2,0 mm



15 cm – 6"
59.46.15

18 cm – 7 1/8"
59.46.18

21 cm – 8 1/4"
59.46.21



Ø 1,0 mm

Ø 1,0 mm

Ø 1,0 mm



15 cm – 6"
59.47.15

18 cm – 7 1/8"
59.47.18

21 cm – 8 1/4"
59.47.21



Ø 2,0 mm

Ø 2,0 mm

Ø 2,0 mm



15 cm – 6"
59.48.15

18 cm – 7 1/8"
59.48.18

21 cm – 8 1/4"
59.48.21



Ti
Titan
Titanium
Titanio
Titane
Titanio

Ringe gerieft
Tips serrated
Anillos estriados
Anneaux striés
Anelli zigrinati

Beschichtung mit Diamantstaub
Coating with diamond dust
Recubierto con polvo de diamante
Revêtement avec de poussière de diamant
Rivestito con polvere di diamante



mit Gewicht
 with weight
 con peso
 avec poids
 con peso



Ø 1,0 mm

Ø 1,0 mm

Ø 1,0 mm

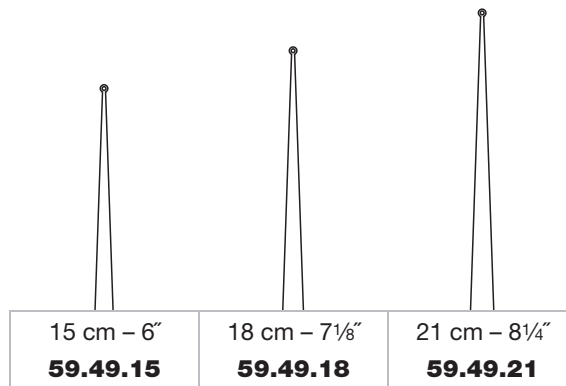

Bajonettpinzetten
 Bayonet forceps
 Pinzas en forma bayoneta
 Pinces en forme baïonnette
 Pinze a forma di baionetta

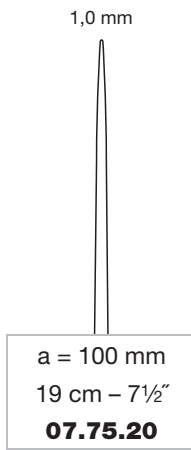

stumpf
 blunt
 roma
 mousse
 smussa

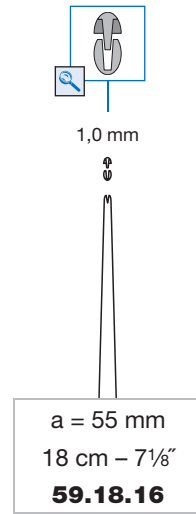

Yasargil



Vergrößerung
 Magnification
 Engrandecimiento
 Agrandissement
 Ingrandimento



Rundgriff
 Round handle
 Mango redondo
 Manche rond
 Manico rotondo



Mikro-Pinzetten
Micro Forceps
Micro pinzas
Micro pinces
Micro pinze

A03



Bajonettpinzetten
 Bayonet forceps
 Pinzas en forma bayoneta
 Pincas en forme baïonnette
 Pinze a forma di baionetta

extrem leicht
 extremely light
 especialmente ligera
 extrêmement légère
 estremamente leggera

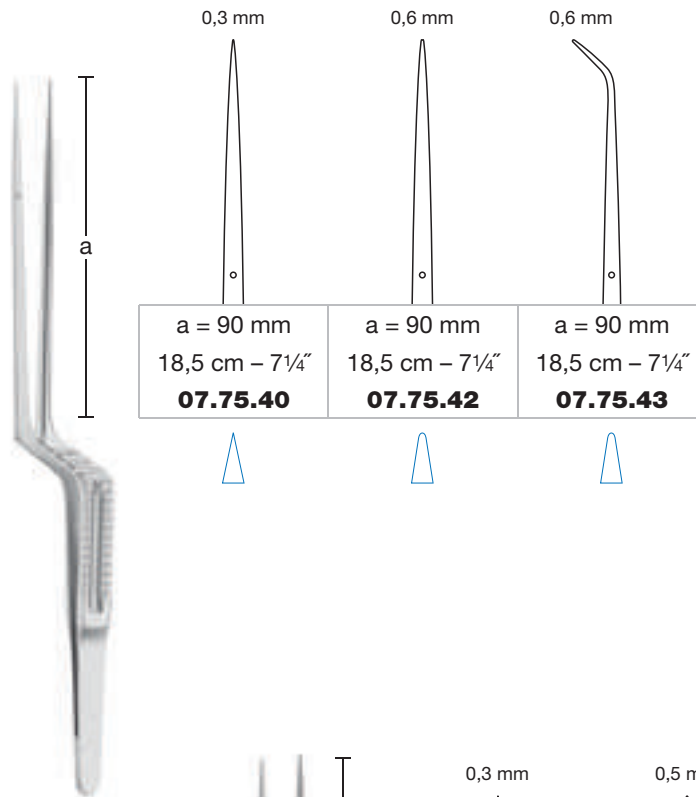

Instrumente mit blau eloxierten
 Leichtmetall-Griffen für höchste
 Präzision und Arbeitskomfort.

Instruments with blue anodized light
 metal handles for maximum precision
 and working convenience.

Instrumentos con mangos de metal
 ligero anodizados en azul para la
 precisión y el confort de trabajo
 máximo.

Instruments avec manches en métal
 léger anodisés en bleu pour un
 maximum de précision et de confort
 à l'utilisation.

Strumenti con manici di metallo
 leggero anodizzati blu per una
 precisione massima e conforto
 lavorativo.

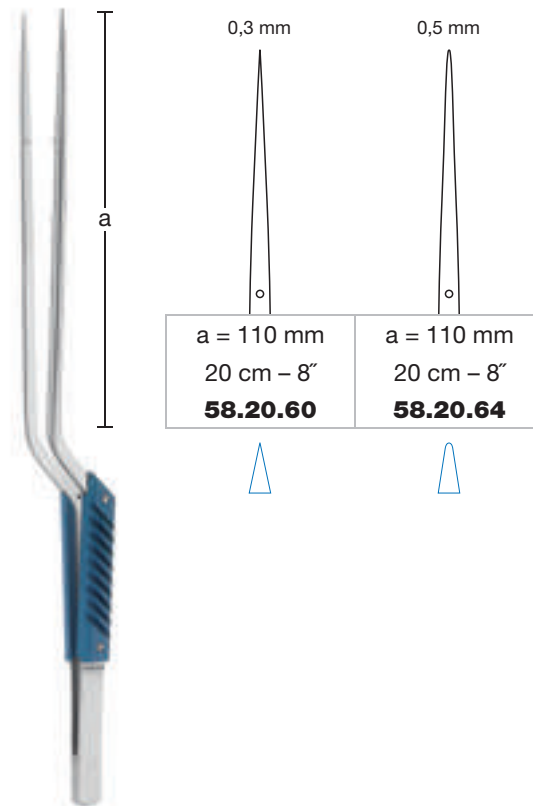

micro 2000



spitz
 sharp
 aguda
 pointu
 acuta



stumpf
 blunt
 roma
 mousse
 smussa

Bajonettpinzetten
 Bayonet forceps
 Pinzas en forma bayoneta
 Pincers en forme baïonnette
 Pinze a forma di baionetta



0,6 mm	0,6 mm	0,6 mm	0,6 mm
a = 55 mm 18 cm – 7 1/8" 59.18.10	a = 75 mm 20 cm – 8" 59.20.10	a = 95 mm 22 cm – 8 3/4" 59.20.16	a = 105 mm 24 cm – 9 1/2" 59.24.10
0,9 mm	0,9 mm	0,9 mm	0,9 mm
a = 55 mm 18 cm – 7 1/8" 59.18.14	a = 75 mm 20 cm – 8" 59.20.14	a = 95 mm 22 cm – 8 3/4" 59.20.18	a = 105 mm 24 cm – 9 1/2" 59.24.14

stump
 blunt
 roma
 mousse
 smussa



A03

Mikro-Pinzetten
Micro Forceps
Micro pinzas
Micro pincers
Micro pinze



Bajonettpinzetten
 Bayonet forceps
 Pinzas en forma bayoneta
 Pincers en forme baïonnette
 Pinze a forma di baionetta



Yasargil

0,6 mm

0,9 mm

a

a

a = 105 mm 23 cm - 9"	a = 105 mm 23 cm - 9"
59.23.10	59.23.14



Ø 3,0 mm



Yasargil

a = 100 mm 22 cm - 8¾"
59.44.50

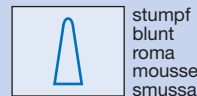
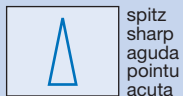

Bajonettpinzetten
Bayonet Forceps
Pinzas en forma bayoneta
Pinces en forme baïonnette
Pinze a forma di baionetta

A03

Bajonettpinzetten
 Bayonet forceps
 Pinzas en forma bayoneta
 Pinces en forme baïonnette
 Pinze a forma di baionetta



a = 80 mm 18,5 cm - 7 1/4"	a = 95 mm 19,5 cm - 7 3/4"	a = 80 mm 18,5 cm - 7 1/4"
07.26.18	07.26.19	07.27.18



Cushing (Taylor)



a = 95 mm 18,5 cm - 7 1/4"
07.26.68



Cushing (Taylor) "HM"



a = 85 mm 16 cm - 6 1/4"	a = 95 mm 19,5 cm - 7 3/4"
07.30.16	07.30.19
a = 85 mm 16 cm - 6 1/4"	a = 95 mm 19,5 cm - 7 3/4"
07.31.16	07.31.19

Gruenwald

"HM"
 Hartmetall
 Tungsten carbide
 Carburo de tungsteno
 Carbure de tungstène
 Carburo di tungsteno

mit Dissektorende
 with dissector end
 con extremo sirviendo de legra
 avec extrémité dissecteur
 con la parte finale a forma di dissettore



Fasspinzetten
Grasping Forceps
Pinzas para agarrar
Pinces pour saisir
Pinze da presa

A03



Hunt



Yasargil

Ø 3 mm	Ø 3 mm	Ø 3 mm
a = 100 mm 22 cm - 8¾"	a = 100 mm 22 cm - 8¾"	a = 100 mm 22 cm - 8¾"
59.44.03	59.44.13	59.44.73
Ø 5 mm	Ø 5 mm	Ø 5 mm
a = 100 mm 22 cm - 8¾"	a = 100 mm 22 cm - 8¾"	a = 100 mm 22 cm - 8¾"
59.44.05	59.44.15	59.44.75

Fasspinzetten und Tumorfasszangen
Grasping Forceps and Tumor Grasping Forceps
Pinzas para agarrar y pinzas para agarrar tumores
Pinces pour saisir et pinces à saisir pour tumeurs
Pinze da presa e pinze per afferrare tumori

A03



Yasargil

Ø 3 mm



a = 40 mm
 16,5 cm – 6½”
59.44.43

Ø 5 mm



a = 40 mm
 16,5 cm – 6½”
59.44.45

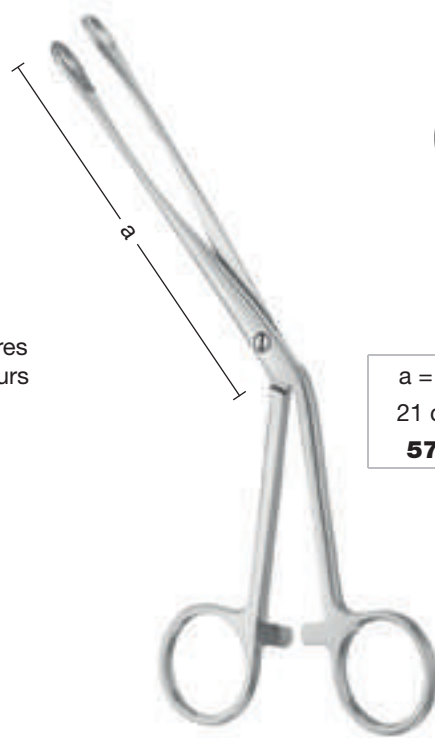

Toennis

Tumorfasszangen
 Tumor grasping forceps
 Pinzas para agarrar tumores
 Pinces à saisir pour tumeurs
 Pinze per afferrare tumori

7 mm



a = 100 mm
 21 cm – 8¼”
57.29.07

10 mm

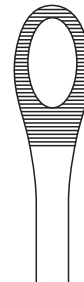

a = 105 mm
 21 cm – 8¼”
57.29.10

12 mm

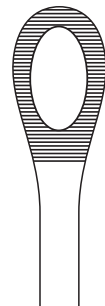

a = 110 mm
 21 cm – 8¼”
57.29.12



Nahtpinzetten
Suturing Forceps
Pinzas para sutura
Pinces à suture
Pinze per sutura

A03

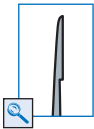

0,3 mm

10,5 cm – 4 1/8"
13.70.42

micro 2000

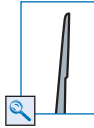

8 mm



0,3 mm



12 cm – 4 3/4"
13.71.50



0,3 mm



15 cm – 6"
13.71.60



0,3 mm



18 cm – 7 1/8"
13.71.70

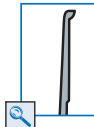

8 mm



0,3 mm



12 cm – 4 3/4"
13.71.52

0,3 mm



15 cm – 6"
13.71.62

0,3 mm



18 cm – 7 1/8"
13.71.72



Rundgriff
Round handle
Mango redondo
Manche rond
Manico rotondo



spitz
sharp
aguda
pointu
acuta



Vergrößerung
Magnification
Engrandecimiento
Agrandissement
Ingrandimento

Nahtpinzetten
Suturing Forceps
Pinzas para sutura
Pinces à suture
Pinze per sutura

A03

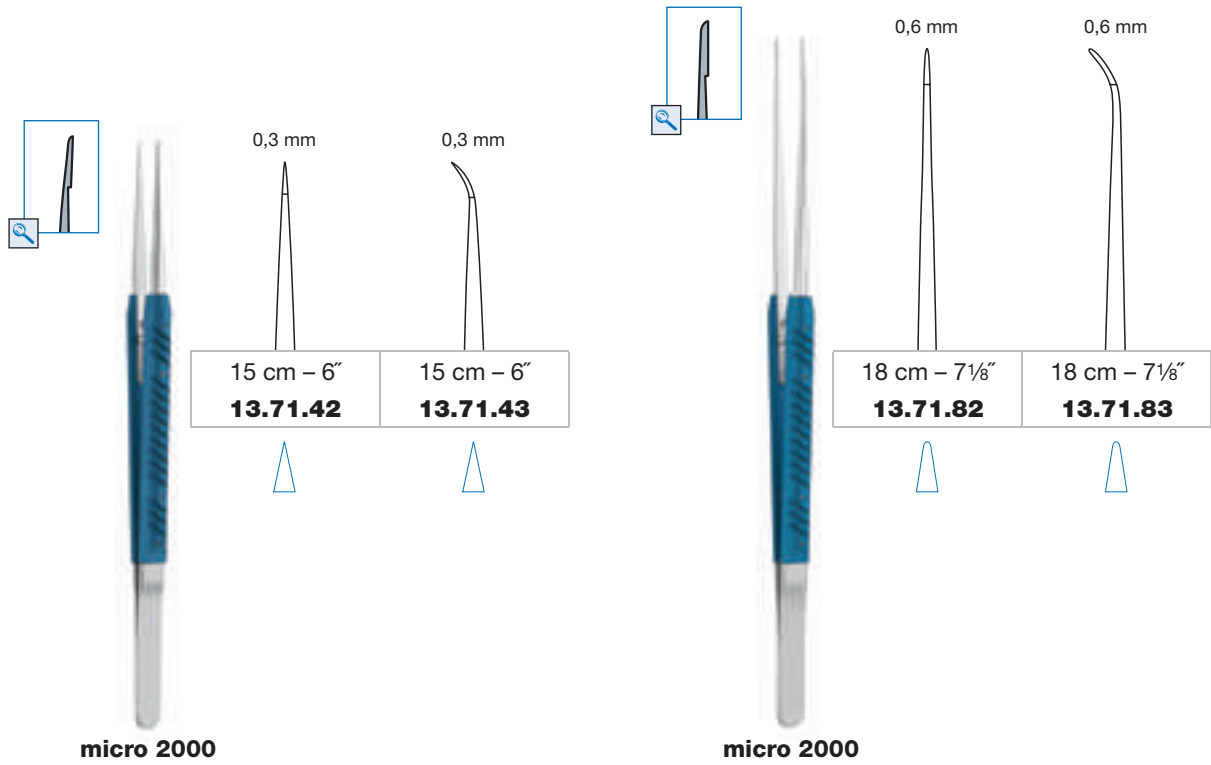

micro 2000

micro 2000



Instrumente mit blau eloxierten Leichtmetall-Griffen für höchste Präzision und Arbeitskomfort.

Instruments with blue anodized light metal handles for maximum precision and working convenience.

Instrumentos con mangos de metal ligero anodizados en azul para la precisión y el confort de trabajo máximo.

Instruments avec manches en métal léger anodisés en bleu pour un maximum de précision et de confort à l'utilisation.

Strumenti con manici di metallo leggero anodizzati blu per una precisione massima e conforto lavorativo.



spitz
sharp
aguda
pointu
acuta



stumpf
blunt
roma
mousse
smussa



Vergrößerung
Magnification
Engrandecimiento
Agrandissement
Ingrandimento



Nahtpinzetten
Suturing Forceps
Pinzas para sutura
Pinces à suture
Pinze per sutura

A03

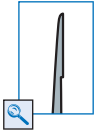

0,5 mm

0,8 mm

14 cm – 5½"

14 cm – 5½"

13.70.72

13.70.74



micro 2000

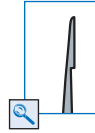

0,3 mm

0,3 mm

12 cm – 4¾"

12 cm – 4¾"

13.71.22

13.71.23



micro 2000

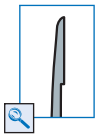

0,6 mm

23 cm – 9"

13.71.84



8 mm

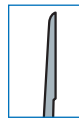

0,8 mm

18 cm – 7½"

13.71.86



Austin



Rundgriff
Round handle
Mango redondo
Manche rond
Manico rotondo



spitz
sharp
aguda
pointu
acuta



stumpf
blunt
roma
mousse
smussa



Vergrößerung
Magnification
Engrandecimiento
Agrandissement
Ingrandimento

Kein Anhaften von Biogewebe ◀
 Schnelle Wärme- und Stromableitung ◀
 Einfache Reinigung ◀

No adhesion of biological tissue ◀
 Quick discharge of heat and current ◀
 Easy to clean ◀

Ninguna adherencia del tejido ◀
 Derivación rápida del calor y corriente ◀
 Mantenimiento fácil ◀

Les tissus ne collent pas à la pince ◀
 Conductivité rapide et sûre de la chaleur et de l'électricité ◀
 Entretien facile ◀

Nessuna adesione di tessuti ◀
 Derivazione veloce di calore e corrente ◀
 Pulizia facile ◀

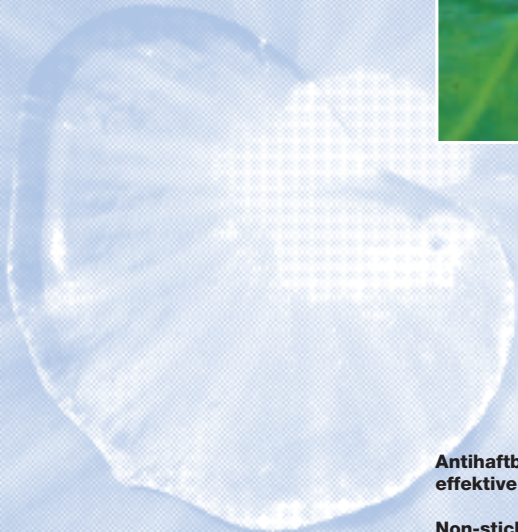

Antihftbeschichtung sorgt für eine effektive Koagulation

Non-stick coating assures an effective coagulation

El recubrimiento no adherente permite una coagulación eficaz

Grâce à ses pointes anti-adhésives, la pince bipolaire permet une meilleure coagulation

Il rivestimento antiaderente permette una coagulazione effettiva

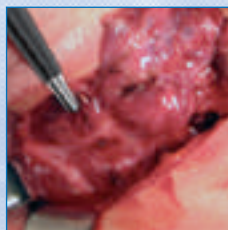



Bipolare Antihaft-Pinzetten
Bipolar Non-stick Forceps
Pinzas bipolares no adherentes
Pinces bipolaires anti-adhésives
Pinze bipolari antiaderenti

A04

MAGIC
non-stick



	0,6 mm	1,0 mm	
	15 cm - 6"	15 cm - 6"	
	88.07.02	88.07.03	
	0,6 mm	1,0 mm	
	18 cm - 7 1/8"	18 cm - 7 1/8"	
	88.07.07	88.07.08	
0,6 mm	1,0 mm		
20 cm - 8"	20 cm - 8"		
88.07.12	88.07.13		
1,3 mm			
20 cm - 8"			
88.07.14			
0,6 mm	1,0 mm		
18 cm - 7 1/8"	18 cm - 7 1/8"		
88.07.07	88.07.08		
2,0 mm			
20 cm - 8"			
88.07.15			

Juwelierpinzetten
Jeweler's forceps
Pinzas para joyero/relojero
Pinces pour joaillier/horloger
Pinze per gioielliere/orologiaio

	0,25 mm	0,6 mm	1,0 mm
	11 cm - 4 3/8"	11 cm - 4 3/8"	11 cm - 4 3/8"
	88.07.81	88.07.82	88.07.83

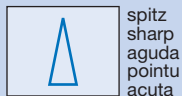

spitz
sharp
aguda
pointu
acuta



stumpf
blunt
roma
mousse
smussa

MAGIC
non-stick

Bipolare Antihaft-Pinzetten
Bipolar Non-stick Forceps
Pinzas bipolares no adherentes
Pinces bipolaires anti-adhésives
Pinze bipolari antiaderenti

A04

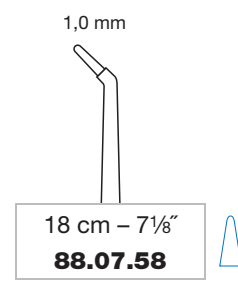
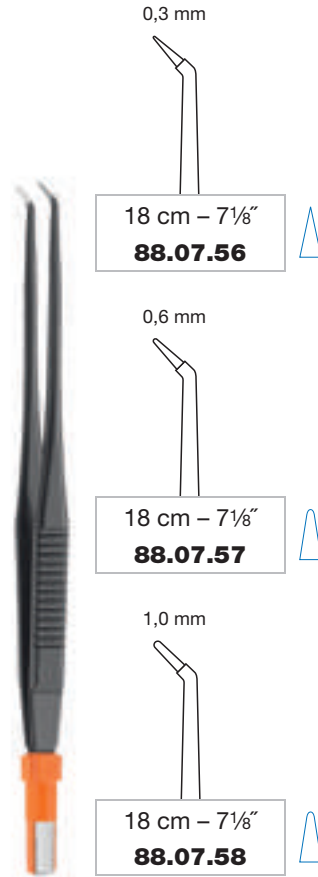
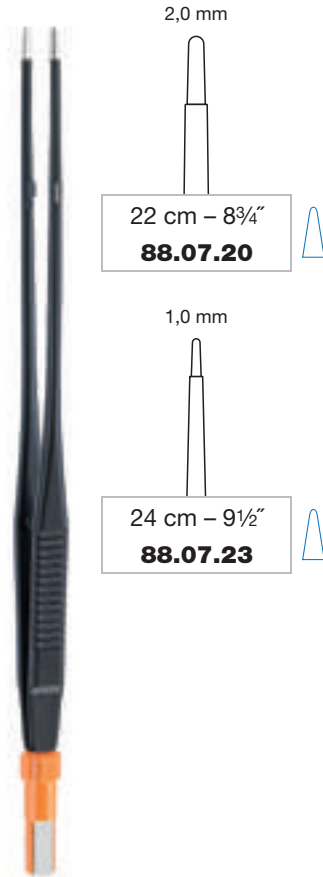

Juwelierpinzetten
Jeweler's forceps
Pinzas para joyero/relojero
Pinces pour joaillier/horloger
Pinze per gioielliere/orologiaio

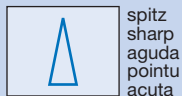
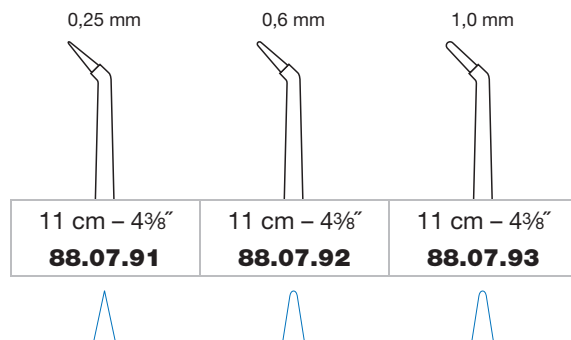

spitz
sharp
aguda
pointu
acuta



stumpf
blunt
roma
mousse
smussa

**A04**

Bipolare Antihaft-Pinzetten
Bipolar Non-stick Forceps
Pinzas bipolares no adherentes
Pinces bipolaires anti-adhésives
Pinze bipolari antiaderenti

MAGIC
non-stick

Bajonettpinzetten
 Bayonet forceps
 Pinzas en forma bayoneta
 Pinces en forme baïonnette
 Pinze a forma di baionetta



a

0,3 mm	0,6 mm	1,0 mm	1,3 mm	2,0 mm
a = 100 mm 20 cm – 8"	a = 100 mm 20 cm – 8"	a = 100 mm 20 cm – 8"	a = 100 mm 20 cm – 8"	a = 100 mm 20 cm – 8"
88.08.01	88.08.02	88.08.03	88.08.04	88.08.05
0,3 mm	0,6 mm	1,0 mm	1,3 mm	2,0 mm
a = 130 mm 22 cm – 8¾"	a = 130 mm 22 cm – 8¾"	a = 130 mm 22 cm – 8¾"	a = 130 mm 22 cm – 8¾"	a = 130 mm 22 cm – 8¾"
88.08.06	88.08.07	88.08.08	88.08.09	88.08.10
0,3 mm	0,6 mm	1,0 mm	1,3 mm	2,0 mm
a = 150 mm 24 cm – 9½"	a = 150 mm 24 cm – 9½"	a = 150 mm 24 cm – 9½"	a = 150 mm 24 cm – 9½"	a = 150 mm 24 cm – 9½"
88.08.11	88.08.12	88.08.13	88.08.14	88.08.15



spitz
sharp
aguda
pointu
acuta



stumpf
blunt
roma
mousse
smussa



MAGIC non-stick



Bipolare Antihaft-Pinzetten
Bipolar Non-stick Forceps
Pinzas bipolares no adherentes
Pinces bipolaires anti-adhésives
Pinze bipolari antiaderenti



A04



Bajonettpinzetten
 Bayonet forceps
 Pinzas en forma bayoneta
 Pinces en forme baïonnette
 Pinze a forma di baionetta



0,3 mm 	0,6 mm 	1,0 mm 
a = 80 mm 18 cm – 7 1/8"	a = 80 mm 18 cm – 7 1/8"	a = 80 mm 18 cm – 7 1/8"
88.08.91	88.08.92	88.08.93

0,3 mm 	0,6 mm 	1,0 mm 
a = 100 mm 20 cm – 8"	a = 100 mm 20 cm – 8"	a = 100 mm 20 cm – 8"
88.08.71	88.08.72	88.08.73

0,3 mm 	0,6 mm 
a = 120 mm 22 cm – 8 3/4"	a = 120 mm 22 cm – 8 3/4"
88.08.76	88.08.77

0,3 mm 	0,6 mm 
a = 140 mm 24 cm – 9 1/2"	a = 140 mm 24 cm – 9 1/2"
88.08.81	88.08.82

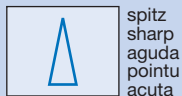

spitz
sharp
aguda
pointu
acuta



stumpf
blunt
roma
mousse
smussa



Bipolare Pinzetten
Bipolar Forceps
Pinzas bipolares
Pinces bipolaires
Pinze bipolari

A04



0,15 mm	0,6 mm	0,15 mm	0,6 mm
16,5 cm – 6½"	16,5 cm – 6½"	16,5 cm – 6½"	16,5 cm – 6½"
88.17.05	88.17.06	88.17.07	88.17.08
0,15 mm	0,6 mm	0,15 mm	0,6 mm
20 cm – 8"	20 cm – 8"	20 cm – 8"	20 cm – 8"
88.20.05	88.20.06	88.20.07	88.20.08

Bajonettpinzetten
 Bayonet forceps
 Pinzas en forma bayoneta
 Pinces en forme baïonnette
 Pinze a forma di baionetta



1,0 mm	1,0 mm
a = 90 mm	a = 90 mm
19 cm – 7½"	19 cm – 7½"
88.70.38	88.70.39



spitz
 sharp
 aguda
 pointu
 acuta



stumpf
 blunt
 roma
 mousse
 smussa

Bipolare Pinzetten
Bipolar Forceps
Pinzas bipolares
Pinces bipolaires
Pinze bipolari

A04



0,15 mm 	0,6 mm 	0,15 mm 	0,6 mm
11 cm – 4 ³ / ₈ " 88.12.05	11 cm – 4 ³ / ₈ " 88.12.06	11 cm – 4 ³ / ₈ " 88.12.07	11 cm – 4 ³ / ₈ " 88.12.08

Bajonettpinzetten
 Bayonet forceps
 Pinzas en forma bayoneta
 Pinces en forme baïonnette
 Pinze a forma di baionetta



0,3 mm 	0,7 mm 	1,2 mm
a = 95 mm 19 cm – 7 ¹ / ₂ " 88.70.05	a = 95 mm 19 cm – 7 ¹ / ₂ " 88.70.06	a = 95 mm 19 cm – 7 ¹ / ₂ " 88.70.16
0,3 mm 	0,7 mm 	1,2 mm
a = 125 mm 22,5 cm – 9"	a = 125 mm 22,5 cm – 9"	a = 125 mm 22,5 cm – 9"
88.23.03	88.23.07	88.23.12
0,3 mm 	0,7 mm 	1,2 mm
a = 145 mm 24 cm – 9 ¹ / ₂ "	a = 145 mm 24 cm – 9 ¹ / ₂ "	a = 145 mm 24 cm – 9 ¹ / ₂ "
88.24.03	88.24.07	88.24.12



spitz
 sharp
 aguda
 pointu
 acuta



stumpf
 blunt
 roma
 mousse
 smussa

**A04**

Bipolare Anschlusskabel und Halteklammer
Bipolar Connecting Cables and Bracket
Cables de conexión bipolar y dispositivo
Câbles connecteurs bipolaires et dispositif
Cavi di connessione bipolari e dispositivo di tenuta

Stecker für Instrumente (siehe Seite 58-63)
 Connector for instruments (see page 58-63)
 Enchufe para instrumentos (véase página 58-63)
 Fiche pour instruments (voir page 58-63)
 Attacco per strumenti (vedi pagina 58-63)

Stecker für Geräte von:
 Connector for generator of:
 Enchufe para equipos de:
 Fiche pour appareils de:
 Attacco per apparecchi:

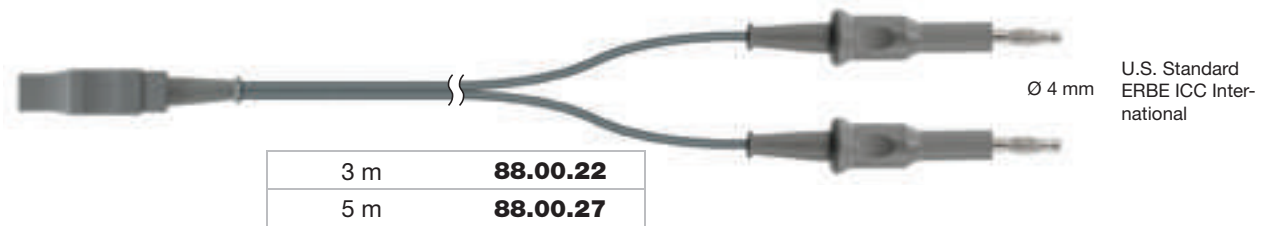
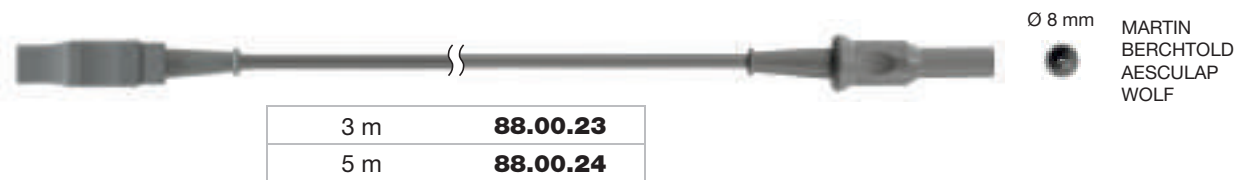
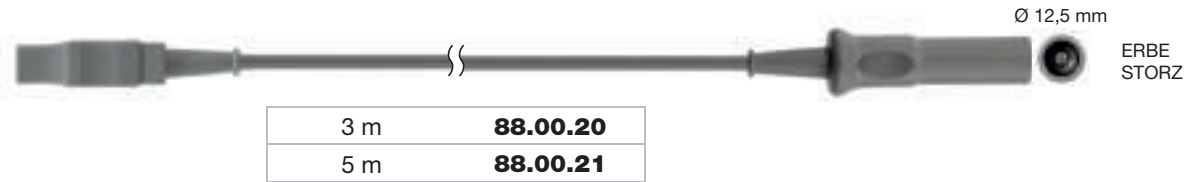

Halteklammer für ein Hochfrequenzkabel mit Knickschutz
Bracket for one high frequency cable with bend protection
Dispositivo para un cable de alta frecuencia con protección contra pliegues de cables
Dispositif pour un câble à haute fréquence avec protection contre plis de câble
Dispositivo di tenuta per un cavo ad alta frequenza con protezione antipiega

- ▶ Passend für Siebkörbe ab ½-Container
- ▶ Sicherheitsverschluss dient auch als Haltegriff
- ▶ Verwendbar für alle Hochfrequenzkabel

- ▶ Suitable for wire baskets starting from ½ container
- ▶ Safety lock serves as handle
- ▶ Suitable for all high frequency cables

- ▶ Aptos para bandejas a partir de ½ contenedor
- ▶ Cierre de seguridad sirve también de mango
- ▶ Utilizable para todos cables de alta frecuencia

- ▶ Approprié pour paniers à partir de ½ container
- ▶ Fermoir de sécurité utilisable comme manche
- ▶ Approprié pour tous types de câbles à haute fréquence

- ▶ Adatto per cestelli da ½ contenitore
- ▶ Chiusura di sicurezza utilizzabile come manico
- ▶ Adatto a tutti i cavi ad alta frequenza



22,5 cm - 9" **88.00.40**



Nadelhalter
Needle Holders
Porta-agujas
Porte-aiguilles
Portaghi

A05



A05

“HM”

Nadelhalter mit Hartmetalleinlagen
 Needle holders with tungsten carbide inserts
 Porta-agujas con bocas revestidas con plaquitas de carburo de tungsteno
 Porte-aiguilles avec mors en carbure de tungstène
 Portaghi con placchette di carburo di tungsteno

N 0,5 mm

normal
 regular
 normal
 normale
 normale

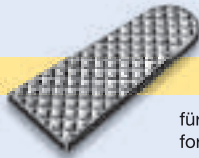

für Nadeln und Nahtmaterial bis Stärke 4-0
 for needles and sutures up to size 4-0
 para agujas y material de sutura hasta el espesor de 4-0
 pour aiguilles et matériel à suture jusqu'à une épaisseur de 4-0
 per aghi e materiale per sutura fino ad uno spessore di 4-0

F 0,4 mm

fein
 fine
 fine
 fine
 fine

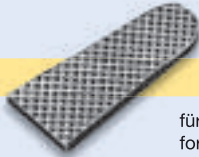

für feine Nadeln und Nahtmaterial in der Stärke 5-0 und 6-0
 for delicate needles and sutures sizes 5-0 and 6-0
 para agujas finas y material de sutura para espesores 5-0 y 6-0
 pour aiguilles fines et matériel à suture d'une épaisseur de 5-0 et 6-0
 per aghi fini e materiale per sutura fino ad uno spessore di 5-0 e 6-0

EF 0,3 mm

extra-fein
 extra-fine
 extra-fino
 extra-fine
 extra-fine

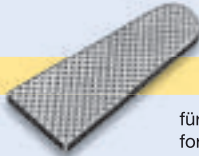

für Mikro-Nadeln und Nahtmaterial bis Stärke 10-0
 for micro-needles and sutures up to size 10-0
 para micro-agujas y material de sutura hasta el espesor de 10-0
 pour micro-aiguilles et matériel à suture jusqu'à une épaisseur de 10-0
 per aghi micro e materiale per sutura fino ad uno spessore di 10-0

glatt
 smooth
 liso
 lisse
 liscia

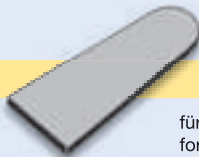

für feine Nadeln und Nahtmaterial in der Stärke 7-0 bis 10-0
 for delicate needles and sutures from sizes 7-0 to 10-0
 para agujas finas y material de sutura para espesores 7-0 y 10-0
 pour aiguilles fines et matériel à suture d'une épaisseur de 7-0 à 10-0
 per aghi fini e materiale per sutura fino ad uno spessore di 7-0 fino a 10-0



12,5 cm – 5"
10.08.62

Neivert "HM"

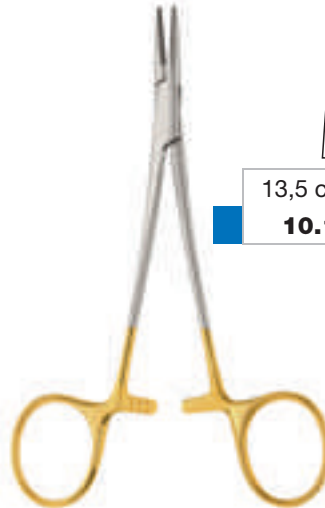

13,5 cm – 5 3/8"
10.10.63

Halsey "HM"



N 14 cm – 5 1/2"
10.14.64

Baumgartner "HM"



■ 7-0 to 10-0
 glatt
 smooth
 liso
 lisse
 liscia

N 4-0
 normal
 regular
 normal
 normale
 normale

"HM"
 Hartmetall
 Tungsten carbide
 Carburo de tungsteno
 Carbure de tungstène
 Carburo di tungsteno



Nadelhalter
Needle Holders
Porta-agujas
Porte-aiguilles
Portaghi

A05



Mayo-Hegar "HM"

N

16 cm – 6¼"
10.18.65

18 cm – 7⅛"
10.18.68

20 cm – 8"
10.18.70

23 cm – 9"
10.18.73

N

24 cm – 9½"
10.18.74

26 cm – 10¼"
10.18.76

30 cm – 11¾"
10.18.80

Ti

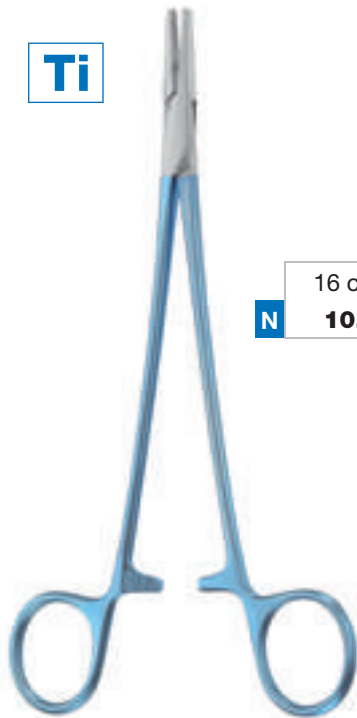

Mayo-Hegar "HM"

N

16 cm – 6¼"
10.18.85

18 cm – 7⅛"
10.18.88

20 cm – 8"
10.18.90

23 cm – 9"
10.18.93

"HM"

Hartmetall
Tungsten carbide
Carburo de tungsteno
Carbure de tungstène
Carburo di tungsteno

Ti

Titan
Titanium
Titanio
Titane
Titano



15 cm – 6"
10.20.14

Baby-Crile-Wood



15 cm – 6" **10.20.15** 18 cm – 7 1/8" **10.20.18**

20 cm – 8" **10.20.20** 23 cm – 9" **10.20.23**

Crile-Wood



Crile-Wood "HM"
(DeBakey "HM")

F 15 cm – 6" **10.20.65** 18 cm – 7 1/8" **10.20.68** 20 cm – 8" **10.20.70** 23 cm – 9" **10.20.73**

F 25 cm – 10" **10.20.75** 26 cm – 10 1/4" **10.20.76** 30 cm – 11 3/4" **10.20.80**

"HM"
 Hartmetall
 Tungsten carbide
 Carburo de tungsteno
 Carbure de tungstène
 Carburo di tungsteno

F
 fein
 fine
 fino
 fine
 fine



Nadelhalter
Needle Holders
Porta-agujas
Porte-aiguilles
Portaghi

A05

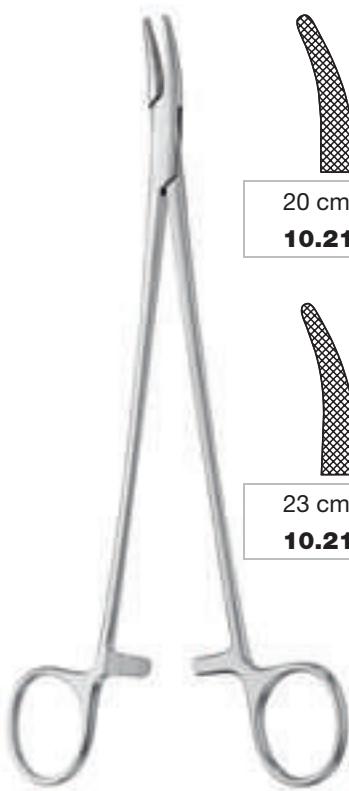

Julian

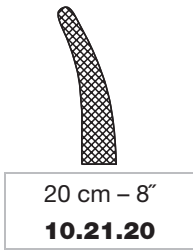

20 cm – 8"
10.21.20

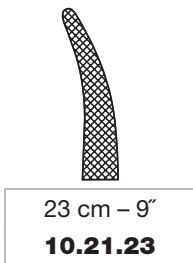

23 cm – 9"
10.21.23

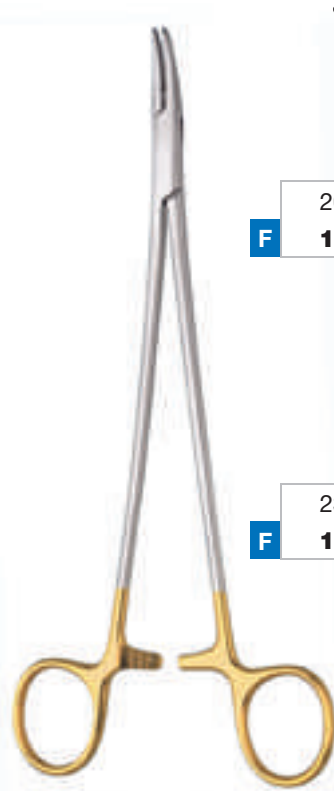

Julian "HM"

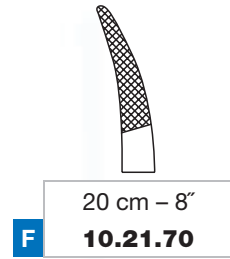

F 20 cm – 8"
10.21.70

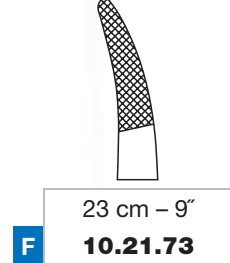

F 23 cm – 9"
10.21.73



Baby-Crile-Wood "HM"

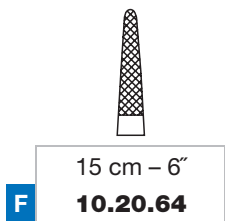

F 15 cm – 6"
10.20.64



Mini-Ryder "HM"

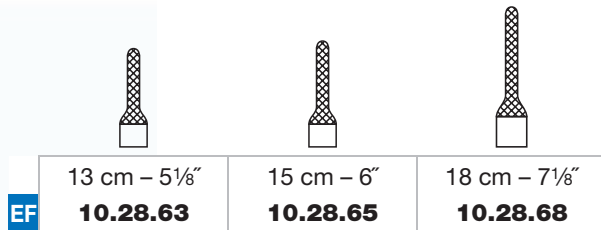

EF 13 cm – 5 1/8"
10.28.63

15 cm – 6"
10.28.65

18 cm – 7 1/8"
10.28.68

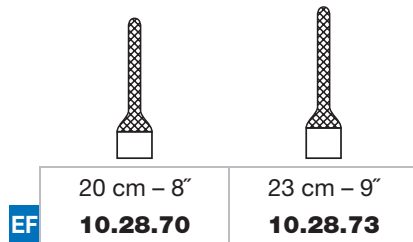

EF 20 cm – 8"
10.28.70

23 cm – 9"
10.28.73

F
5-0 to 6-0
fein
fine
fino
fine
fine

EF
10-0
extra-fein
extra-fine
extra-fino
extra-fine
extra-fine

"HM"
Hartmetall
Tungsten carbide
Carburo de tungsteno
Carbure de tungstène
Carburo di tungsteno

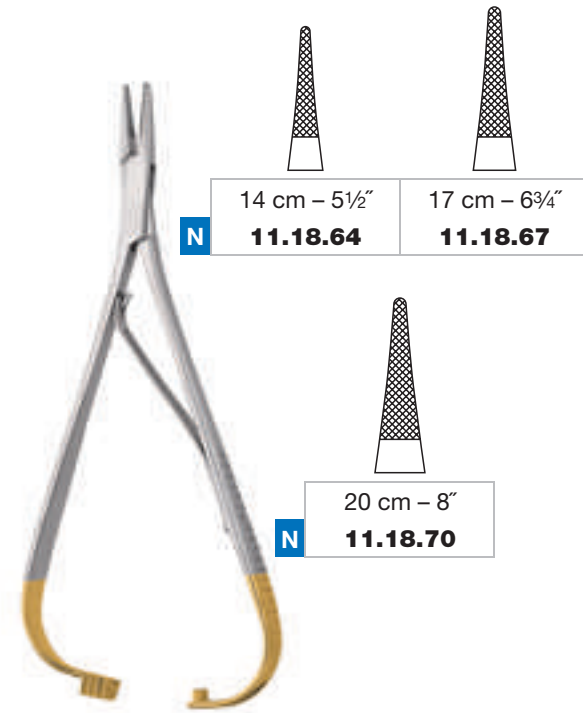

N

14 cm – 5½"

11.18.64

17 cm – 6¾"

11.18.67

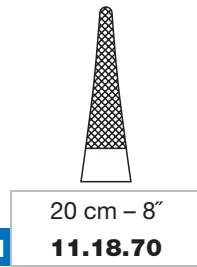

N

20 cm – 8"

11.18.70

Mathieu-Kocher "HM"

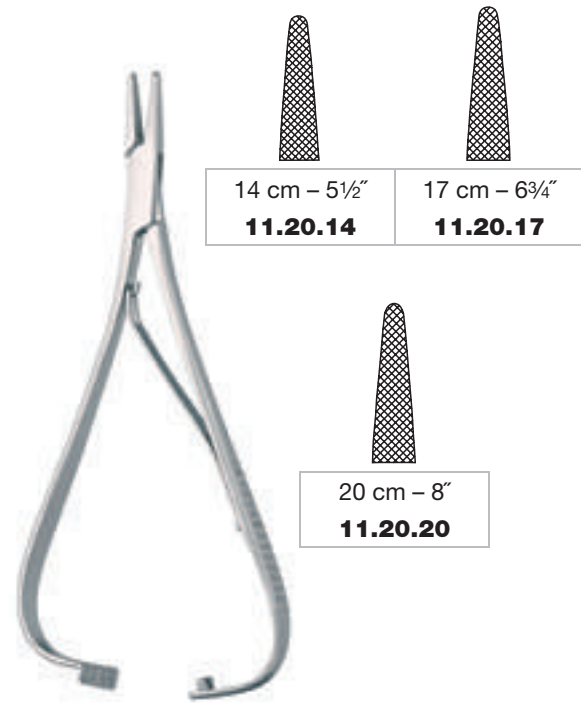

14 cm – 5½"

11.20.14

17 cm – 6¾"

11.20.17

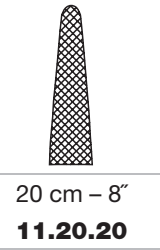

20 cm – 8"

11.20.20

Mathieu

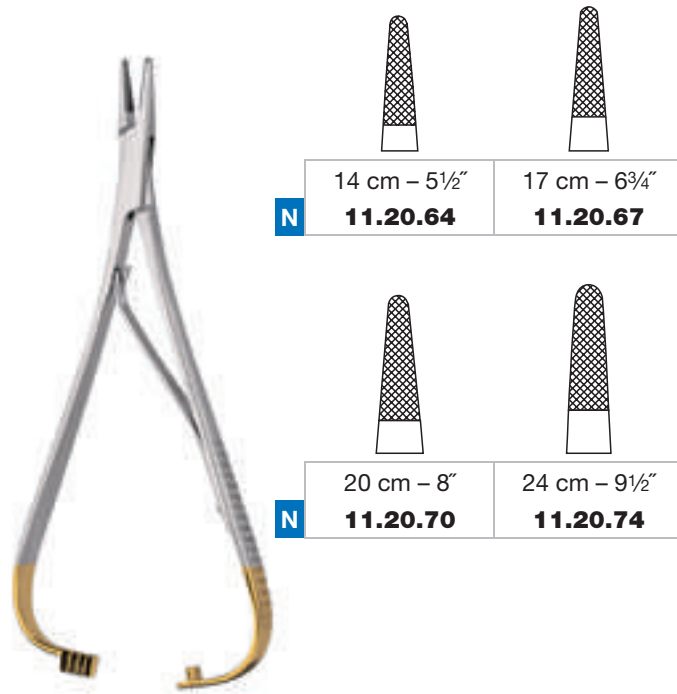

N

14 cm – 5½"

11.20.64

17 cm – 6¾"

11.20.67

N

20 cm – 8"

11.20.70

24 cm – 9½"

11.20.74

Mathieu "HM"

"HM"

Hartmetall
 Tungsten carbide
 Carburo de tungsteno
 Carbure de tungstène
 Carburo di tungsteno

N

4-0

normal
 regular
 normal
 normale
 normale

**A05**

Nadelhalter und Mikro-Nadelhalter
Needle Holders and Micro Needle Holders
Porta-agujas y micro porta-agujas
Porte-aiguilles et micro porte-aiguilles
Portaghi e micro portaghi



N	16 cm – 6¼"	18 cm – 7½"
	11.34.66	11.34.68

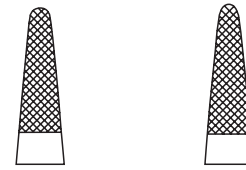

N	16 cm – 6¼"	18 cm – 7½"
	11.36.66	11.36.68

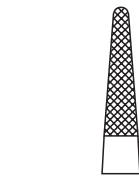

N	20 cm – 8"
	11.34.70



N	20 cm – 8"
	11.36.70

Toennis "HM"**Langenbeck "HM"**

Mikro-Nadelhalter
 Micro needle holders
 Micro porta-agujas
 Micro porte-aiguilles
 Micro portaghi



	13 cm – 8½"
	11.62.63

**Castroviejo "HM"**

	14 cm – 5½"	17 cm – 6¾"
	11.62.14	11.62.17



	14 cm – 5½"	17 cm – 6¾"
	11.62.15	11.62.18

Castroviejo

	glatt smooth liso liscia
7-0 to 10-0	

N	normal regular normal normale normale
4-0	

"HM"	Hartmetall Tungsten carbide Carburo de tungsteno Carbure de tungstène Carburo di tungsteno
-------------	--

	mit Sperre with catch con cremallera avec crémaillère con cremagliera
--	---



Castroviejo-micro



14,5 cm – 5¾"
11.70.22



14,5 cm – 5¾"
11.70.23



14,5 cm – 5¾"
11.70.24



14,5 cm – 5¾"
11.70.25



11,5 cm – 4½"
11.74.13



14 cm – 5½"
11.74.23



11,5 cm – 4½"
11.74.15



14 cm – 5½"
11.74.25



Barraquer



14 cm – 5½"
11.62.64



17 cm – 6¾"
11.62.67



14 cm – 5½"
11.62.84



17 cm – 6¾"
11.62.87



Castroviejo "HM"

"HM"

Hartmetall
 Tungsten carbide
 Carburo de tungsteno
 Carbure de tungstène
 Carburo di tungsteno

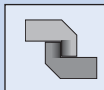

mit Sperre
 with catch
 con cremallera
 avec crémaillère
 con cremagliera

EF

10-0

extra-fein
 extra-fine
 extra-fino
 extra-fine
 extra-fine

7-0 to 10-0

glatt
 smooth
 liso
 lisse
 liscia



A05

Mikro-Nadelhalter
Micro Needle Holders
Micro porta-agujas
Micro porte-aiguilles
Micro portaghi



Jacobson



18,5 cm – 7¼"
11.82.18



21 cm – 8¼"
11.82.21



Jacobson "HM"



18,5 cm – 7¼"
11.80.68



21 cm – 8¼"
11.80.71



18,5 cm – 7¼"
11.82.68



21 cm – 8¼"
11.82.71



Yasargil



16 cm – 6¼"
12.15.50



16 cm – 6¼"
12.15.51



Jacobson "HM"



18 cm – 7⅛"
11.84.68



18 cm – 7⅛"
11.85.68





18 cm – 7⅛"
11.86.68



18 cm – 7⅛"
11.87.68



 glatt
smooth
liso
liscia

 fein
fine
fino
fine

"HM" Hartmetall
Tungsten carbide
Carburo de tungsteno
Carbure de tungstène
Carburo di tungsteno

 mit Sperre
with catch
con cremallera
avec crémaillère
con cremagliera

Mikro-Nadelhalter
Micro Needle Holders
Micro porta-agujas
Micro porte-aiguilles
Micro portaghi

A05

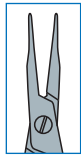

0,4 mm



0,4 mm



0,5 mm



0,5 mm



13 cm – 5 1/8"	12.12.54	12.12.55		12.12.59
15 cm – 6"	12.15.76	12.15.77		
18 cm – 7 1/8"	12.18.76	12.18.77	12.18.80	12.18.81
21 cm – 8 1/4"	12.21.76	12.21.77	12.21.80	12.21.81

15 cm – 6"	12.15.56	12.15.57			
18 cm – 7 1/8"	12.18.56	12.18.57	12.18.60	12.18.61	
21 cm – 8 1/4"	12.21.56	12.21.57	12.21.60	12.21.61	

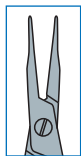

0,4 mm



0,4 mm



0,5 mm



0,5 mm



13 cm – 5 1/8"	12.12.56	12.12.57		12.12.61
15 cm – 6"	12.15.78	12.15.79		
18 cm – 7 1/8"	12.18.78	12.18.79	12.18.82	12.18.83
21 cm – 8 1/4"	12.21.78	12.21.79	12.21.82	12.21.83

15 cm – 6"	12.15.66	12.15.67			
18 cm – 7 1/8"	12.18.66	12.18.67	12.18.68	12.18.69	
21 cm – 8 1/4"	12.21.66	12.21.67	12.21.70	12.21.71	

mit Sperre
with catch
con cremallera
avec crémaillère
con cremagliera

Beschichtung mit Diamantstaub
Coating with diamond dust
Recubierto con polvo de diamante
Revêtement avec de poussière de diamant
Rivestito con polvere di diamante

Rundgriff
Round handle
Mango redondo
Manche rond
Manico rotondo

**A05**

Mikro-Nadelhalter
Micro Needle Holders
Micro porta-agujas
Micro porte-aiguilles
Micro portaghi

**micro 2000**

15 cm – 6"
12.15.70



15 cm – 6"
12.15.71



18 cm – 7 1/8"
12.18.70



18 cm – 7 1/8"
12.18.71

**micro 2000**

15 cm – 6"
12.15.72



15 cm – 6"
12.15.73



18 cm – 7 1/8"
12.18.72



18 cm – 7 1/8"
12.18.73



18 cm – 7 1/8"
12.18.74



18 cm – 7 1/8"
12.18.75



Instrumente mit blau eloxierten
 Leichtmetall-Griffen für höchste
 Präzision und Arbeitskomfort.

Instruments with blue anodized light
 metal handles for maximum precision
 and working convenience.

Instrumentos con mangos de metal
 ligero anodizados en azul para la
 precisión y el confort de trabajo
 máximo.

Instruments avec manches en métal
 léger anodisés en bleu pour un
 maximum de précision et de confort
 à l'utilisation.

Strumenti con manici di metallo
 leggero anodizzati blu per una
 precisione massima e conforto
 lavorativo.

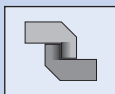

mit Sperre
 with catch
 con cremallera
 avec crémaillère
 con cremagliera



Beschichtung mit Diamantstaub
 Coating with diamond dust
 Recubierto con polvo de diamante
 Revêtement avec de poussière de diamant
 Rivestito con polvere di diamante

Mikro-Nadelhalter
Micro Needle Holders
Micro porta-agujas
Micro porte-aiguilles
Micro portaghi

A05

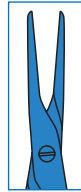

Ti

8 mm



15 cm – 6"
12.16.75



18 cm – 7 1/8"
12.18.85



21 cm – 8 1/4"
12.21.95



15 cm – 6"
12.16.77



18 cm – 7 1/8"
12.18.87



21 cm – 8 1/4"
12.21.97

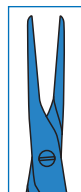

Ti

8 mm



15 cm – 6"
12.16.76



18 cm – 7 1/8"
12.18.86



21 cm – 8 1/4"
12.21.96



15 cm – 6"
12.16.78



18 cm – 7 1/8"
12.18.88



21 cm – 8 1/4"
12.21.98



Mikro-Nadelhalter
Micro Needle Holders
Micro porta-agujas
Micro porte-aiguilles
Micro portaghi

A05



micro 2000

12 cm - 4¾"	12 cm - 4¾"
12.12.40	12.12.41

12 cm - 4¾"	12 cm - 4¾"
12.12.42	12.12.43

12 cm - 4¾"
12.12.48



micro 2000

15 cm - 6"	15 cm - 6"
12.15.30	12.15.31

15 cm - 6"	15 cm - 6"
12.15.32	12.15.33



Yasargil

a = 70 mm 16 cm - 6¼"	a = 90 mm 18,5 cm - 7¼"
58.16.45	58.19.45

a = 70 mm 16 cm - 6¼"	a = 90 mm 18,5 cm - 7¼"
58.16.48	58.19.40



Yasargil

a = 85 mm 20 cm - 8"	a = 100 mm 23 cm - 9"
59.20.40	59.23.42

a = 85 mm 20 cm - 8"	a = 100 mm 23 cm - 9"
59.20.45	59.23.45

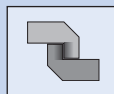

mit Sperre
with catch
con cremallera
avec crémaillère
con cremagliera

Saug- und Spülinstrumente
Suction and Irrigating Instruments
Instrumentos de aspiración y de lavado
Instruments à aspiration et à irrigation
Strumenti per aspirazione e lavaggio

A06

Konisches Saugrohr verhindert ein Verstopfen der Kanüle
 Bajonettverschluss für schnellen Kanülenwechsel
 Einfache Zerlegbarkeit für optimale Reinigung

Conical suction tube prevents clogging of the cannula
 Bayonet joint for quick cannula changes
 Easy dismantling for best possible cleaning

La cánula cónica de succión evita la obstrucción de la misma
 Cierre de bayoneta para el cambio rápido de las cánulas
 Fácil desmontaje para una limpieza óptima

Un tuyau conique prévient le colmatage de la canule
 Fermeture de type baïonnette pour un remplacement rapide de la canule
 Démontage facile pour un nettoyage optimal

Cannule d'aspirazione coniche per evitare che si otturino
 Attacco a baionetta per una rapida sostituzione della cannula
 Facile da smontare per una pulizia ottimale



Progressive und ergonomische Regulierung der Saugkraft
Progressive and ergonomic adjustment of the suction power
Regulación progresiva y ergonómica de la potencia de aspiración
Réglage progressif et ergonomique de la puissance d'aspiration
Regolazione progressiva ed ergonomica dell'intensità d'aspirazione

entwickelt in Zusammenarbeit mit:
 developed in cooperation with:
 desarrollado en colaboración con:
 développée en collaboration avec:
 sviluppato in collaborazione con:

Prof. Marco Cenzato
 Head of Department Neuro Surgery
 Hospital Niguarda Ca' Granda - Milan

**A06**

Saug- und Spülinstrumente
Suction and Irrigating Instruments
Instrumentos de aspiración y de lavado
Instrumenti à aspiration et à irrigation
Strumenti per aspirazione e lavaggio

P ♦ E ♦ N

Handgriff mit drehbarem Schlauchansatz
 Handle with rotatable tube connection
 Mango con empalme giratorio para tubo
 Manche avec embout de tuyau pivotant
 Manico con attacco girevole per tubo

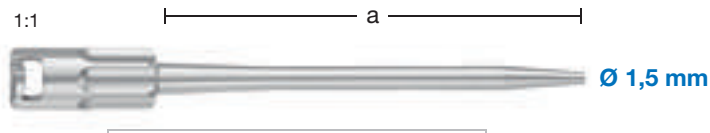
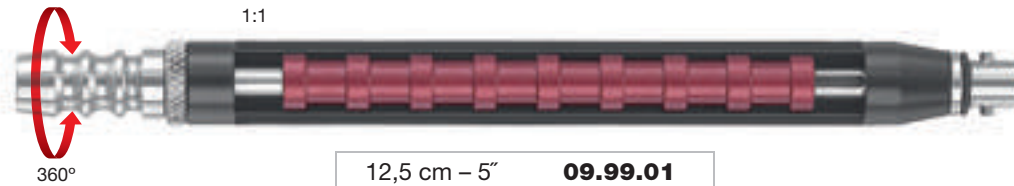

a = 55 mm	09.99.07
a = 90 mm	09.99.08
a = 110 mm	09.99.09

Saugkanülen (biegbar)
 Suction cannulas (malleable)
 Cánulas de aspiración (maleables)
 Canules à aspiration (malléables)
 Cannule per aspirazione (malleabili)

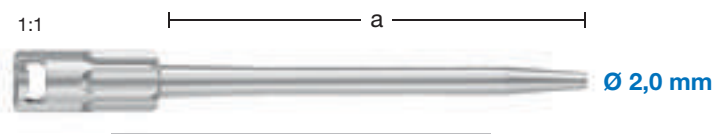

a = 55 mm	09.99.11
a = 90 mm	09.99.12
a = 110 mm	09.99.13

Ersatz-O-Ring
 Replacement O-ring
 Anillo tórico de repuesto
 Joint torique de rechange
 Guarnizione circolare di ricambio



P₁₀ **909.81.01**



Verpackungseinheit "X" Stück
 Packing unit "X" pieces
 Paquete de "X" unidades
 Emballage de "X" pièces
 Confezione da "X" pezzi



Saugkanülenrohre sind konisch
 Conical shape of the suction cannules
 Forma cónica de la cánulas
 Canules de forme conique
 Cannule di forma conica



biegbar
 malleable
 maleables
 malléables
 malleabili



Saug- und Spülinstrumente
Suction and Irrigating Instruments
Instrumentos de aspiración y de lavado
Instrumenti à aspiration et à irrigation
Strumenti per aspirazione e lavaggio

A06

Punktionskanülen
 Puncture cannulas
 Cánulas para punción
 Canules à ponction
 Cannule per puntura



Quincke

a = 80 mm	09.72.07	Ø 0,7 mm
a = 90 mm	09.72.08	Ø 0,7 mm
a = 80 mm	09.72.10	Ø 1,0 mm
a = 90 mm	09.72.11	Ø 1,0 mm
a = 90 mm	09.72.12	Ø 1,2 mm
a = 100 mm	09.72.13	Ø 1,2 mm
a = 150 mm	09.72.14	Ø 1,2 mm



Tuohy

a = 80 mm	09.73.12	Ø 1,30 mm
a = 80 mm	09.73.14	Ø 1,50 mm
a = 80 mm	09.73.16	Ø 1,65 mm



Bier

a = 80 mm	09.73.92	Ø 1,2 mm
a = 90 mm	09.73.93	Ø 1,2 mm



Klima-Rosegger

a = 35 mm	09.70.18	Ø 1,8 mm
-----------	-----------------	----------

graduirt in cm
 graduated in cms
 graduado en cm
 graduée en cm
 graduato in cm



Frazier

a = 100 mm	57.39.02	Ø 2,0 mm
------------	-----------------	----------

**A06**

Saug- und Spülinstrumente
Suction and Irrigating Instruments
Instrumentos de aspiración y de lavado
Instrumenti à aspiration et à irrigation
Strumenti per aspirazione e lavaggio

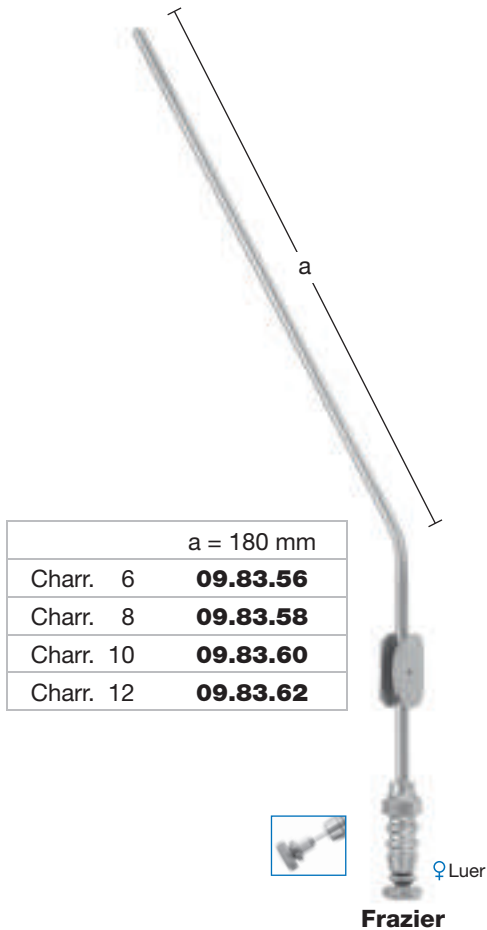
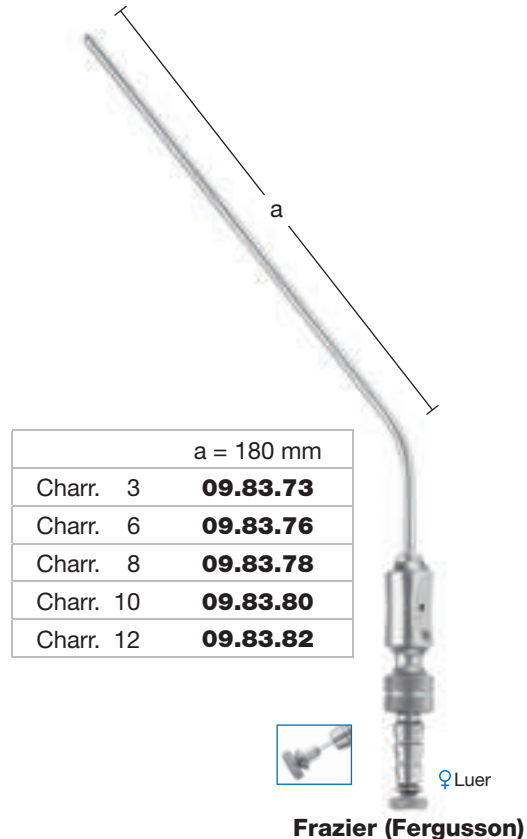
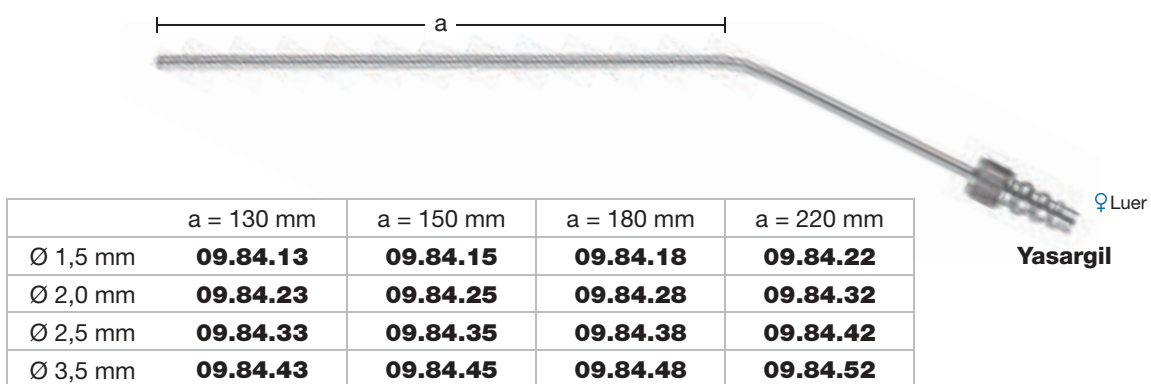
**Frazier****Frazier (Fergusson)****Yasargil**

mit Mandrin
 with guide
 con mandril
 avec mandrin
 con mandrino

Saug- und Spülinstrumente
Suction and Irrigating Instruments
Instrumentos de aspiración y de lavado
Instrumenti à aspiration et à irrigation
Strumenti per aspirazione e lavaggio

A06

Bajonett-Saugkanüle
 Bayonet suction cannula
 Cánula de aspiración en forma bayoneta
 Canule à aspiration en forme baïonnette
 Cannula per aspirazione a forma di baionetta



Charr.	9	09.83.99	22,5 cm – 9"
--------	---	-----------------	--------------

„Tropfen“-Saugkanülen (biegbar)
 “Drop-shape design” suction cannulas (malleable)
 Cánulas de aspiración con dispositivo en forma de “gota” (maleables)
 Canules à aspiration avec dispositif en forme de “goutte” (malléables)
 Cannule per aspirazione con dispositivo a forma di “goccia” (malleabili)



Saugkraft ist durch die Saugunterbrechung regulierbar
 Interruption of suction power by taking off the thumb
 Interrupción de la fuerza de succión al destapar la apertura
 Réglage de la succion en retirant le doigt du dispositif
 Controllo della capacità di aspirazione tramite il dispositivo



	a = 120 mm	a = 150 mm
Ø 1,0 mm	58.24.15	58.24.21
Ø 1,5 mm	58.24.16	58.24.22
Ø 2,0 mm	58.24.17	58.24.23
Ø 2,5 mm	58.24.18	58.24.24
Ø 3,0 mm	58.24.19	58.24.25
Ø 4,0 mm	58.24.20	58.24.26
Ø 5,0 mm	58.24.30	58.24.31



Saugkanülenrohre sind konisch
 Conical shape of the suction cannules
 Forma cónica de la cánula
 Canules de forme conique
 Cannule di forma conica



mit Mandrin
 with guide
 con mandril
 avec mandrin
 con mandrino



biegbar
 malleable
 maleables
 malléables
 malleabili

medicon-cat NEURO

Für unsere Partner organisieren wir Fortbildungsveranstaltungen und bieten Seminare an. Auch weiterbildende Literatur und CD's stellen wir gerne zur Verfügung.

We organise training courses and offer seminars for our business partners. We also assist our clients with sales tools like literature and CDs.

Ofrecemos seminarios y organizamos cursillos de perfeccionamiento para nuestros clientes. También ponemos a su disposición literatura y CDs.

Pour nos partenaires, nous organisons des séminaires de formation continue. Nous proposons également des livres et des CDRoms de perfectionnement, car, comme nous le savons, le service relie les hommes.

Organizziamo corsi di perfezionamento professionale per i nostri partner ed offriamo seminari. Mettiamo a disposizione volentieri anche letteratura di perfezionamento professionale e CD.



451.07.00

Titan-Clips
Titanium Clips
Clips de titanio
Clips en titane
Clip in titanio

A07

Titan-Clips
 Titanium clips
 Clips de titanio
 Clips en titane
 Clip in titanio

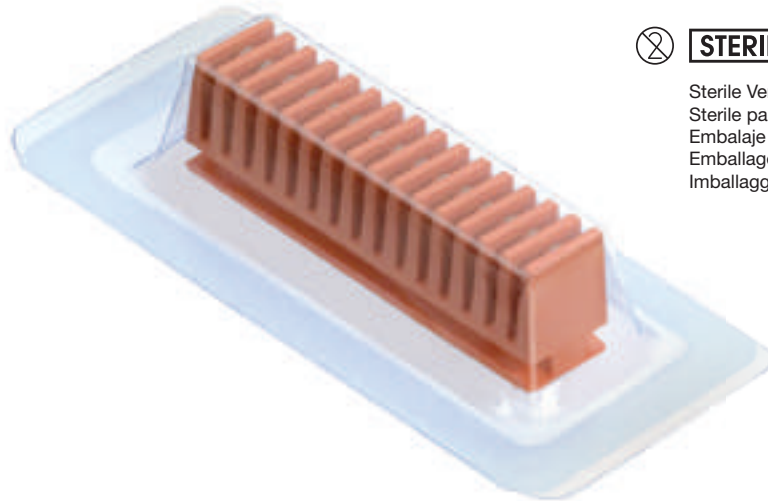

STERILE

Sterile Verpackung
 Sterile packaging
 Embalaje estéril
 Emballage stérile
 Imballaggio sterile

1:1				
	klein small pequeño petit piccolo	mittel medium mediano moyen medio	mittelgroß medium large medio grande moyen grand medio grande	groß large grande grand grande
	12 × 25 56.50.01	10 × 25 56.50.02	16 × 10 56.50.03	10 × 15 56.50.04
1:1				
	klein small pequeño petit piccolo	mittel medium mediano moyen medio	groß large grande grand grande	
	24 × 10 56.50.11	20 × 10 56.50.12	12 × 10 56.50.14	



Verpackungseinheit "X" Stück
 Packing unit "X" pieces
 Paquete de "X" unidades
 Emballage de "X" pièces
 Confezione da "X" pezzi

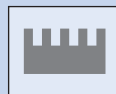

Magazine × Clips
 Storage tray × clips
 Cartucho × clips
 Cartouche × clips
 Cartuccia × clip



Einmalprodukt
 Single use product
 Producto para un solo uso
 Produit à usage unique
 Prodotto monouso

**A07**

Anlegezangen für Titan-Clips
Applying Forceps for Titanium Clips
Pinzas para aplicar para clips de titanio
Pinces à poser pour clips en titane
Pinze per applicare per clip in titanio



Clipmagazine und Anlegezangen mit gleicher Farbcodierung
Clip storage trays and applying forceps with matching color code
Dispositivo de clips y pinzas aplicadoras con la misma codificación de color
Magasins de clips et pinces à appliquer avec le même code couleur
Cartucce per clip e pinze per applicare con codice colore uguale

Anlegezangen
 Applying forceps
 Pinzas para aplicar
 Pinces à appliquer
 Pinze per applicare

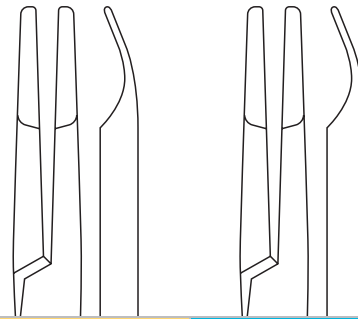

15 cm - 6"	15 cm - 6"
56.50.15	56.50.25
19,5 cm - 7¾"	19,5 cm - 7¾"
56.50.19	56.50.29

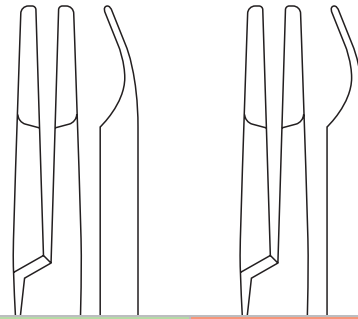

20,5 cm - 8⅛"	20,5 cm - 8⅛"
56.50.30	56.50.40



Wundhaken und Wundspreizer
Retractors and Self-retaining Retractors
Separadores y separadores autoestáticos
Ecarteurs et ecarteurs autostatiques
Divaricatori e divaricatori autostatici

A08

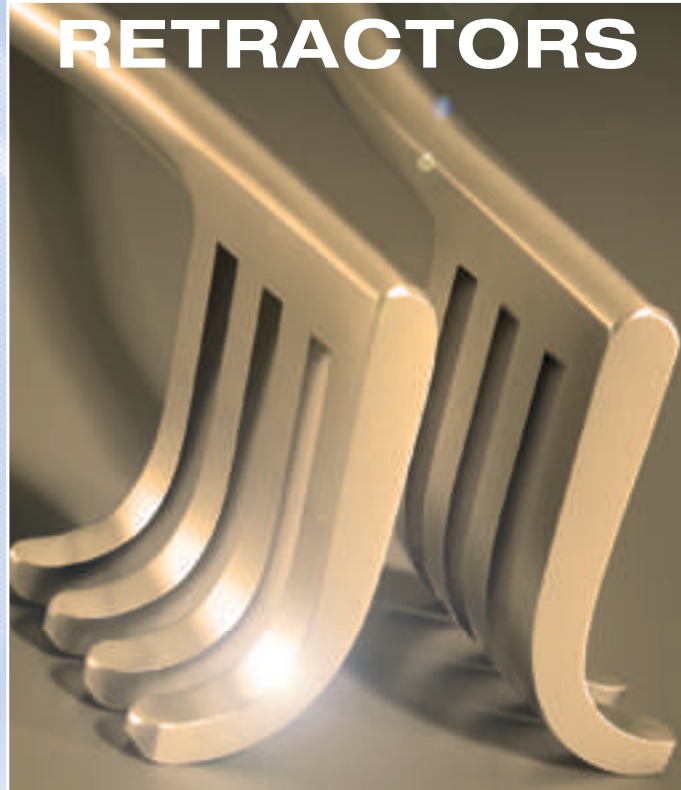

**A08**

Wundhaken
Retractors
Separadores
Ecarteurs
Divaricatori

Wundhaken für vordere Spondylosen-Operationen
 Retractors for anterior spondylosis operations
 Separadores para intervenciones anteriores de espondilosis
 Ecarteurs pour opérations de spondyloses antérieures
 Divaricatori per interventi di spondilosi anteriori

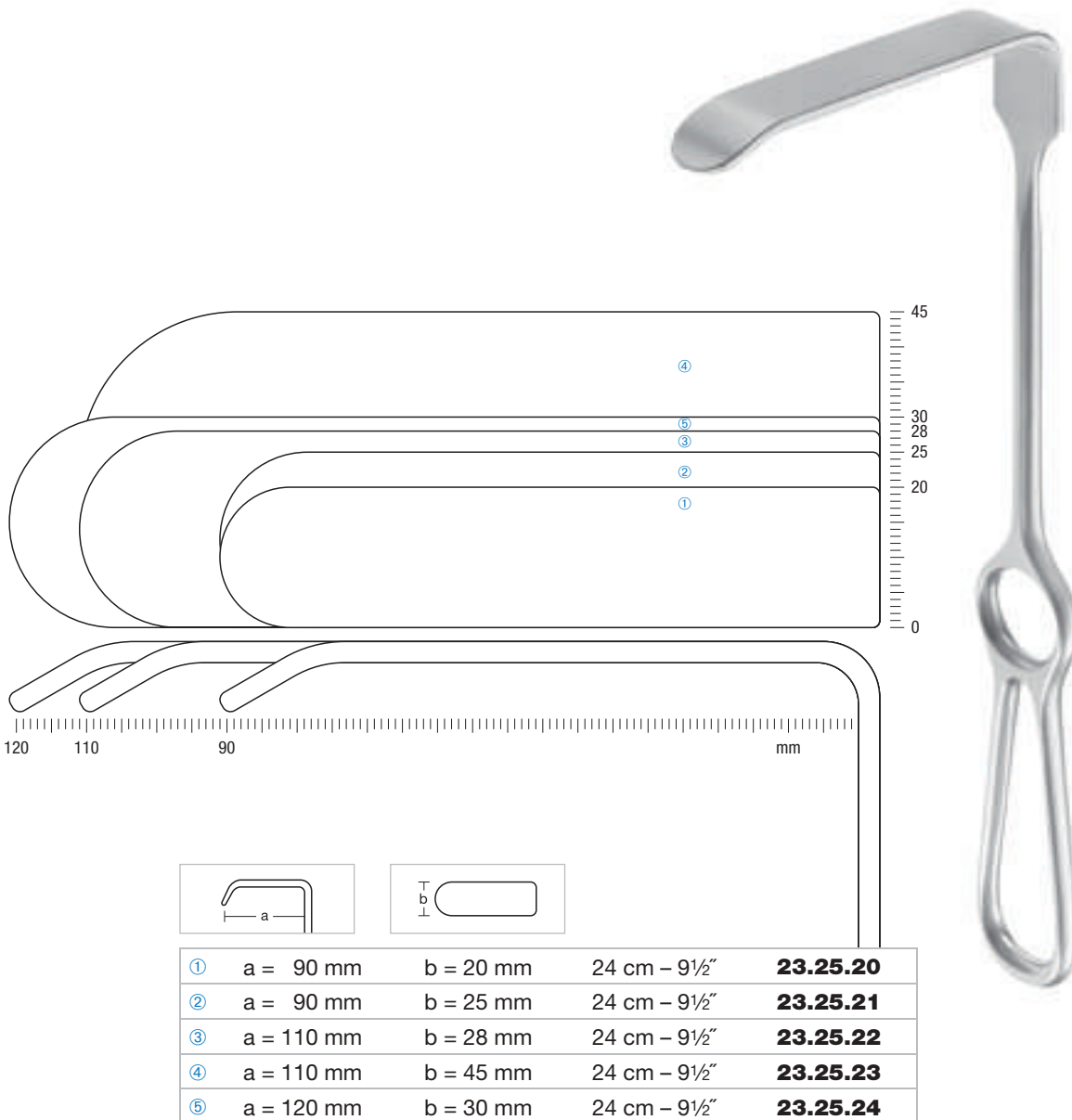

Wundhaken für vordere Spondylosen-Operationen, gezahnt
Retractors for anterior spondylosis operations, serrated
Separadores para intervenciones anteriores de spondilosis, dentado
Ecarteurs pour opérations de spondyloses antérieures, dentelé
Divaricatori per interventi di spondilosi anteriori, dentellato

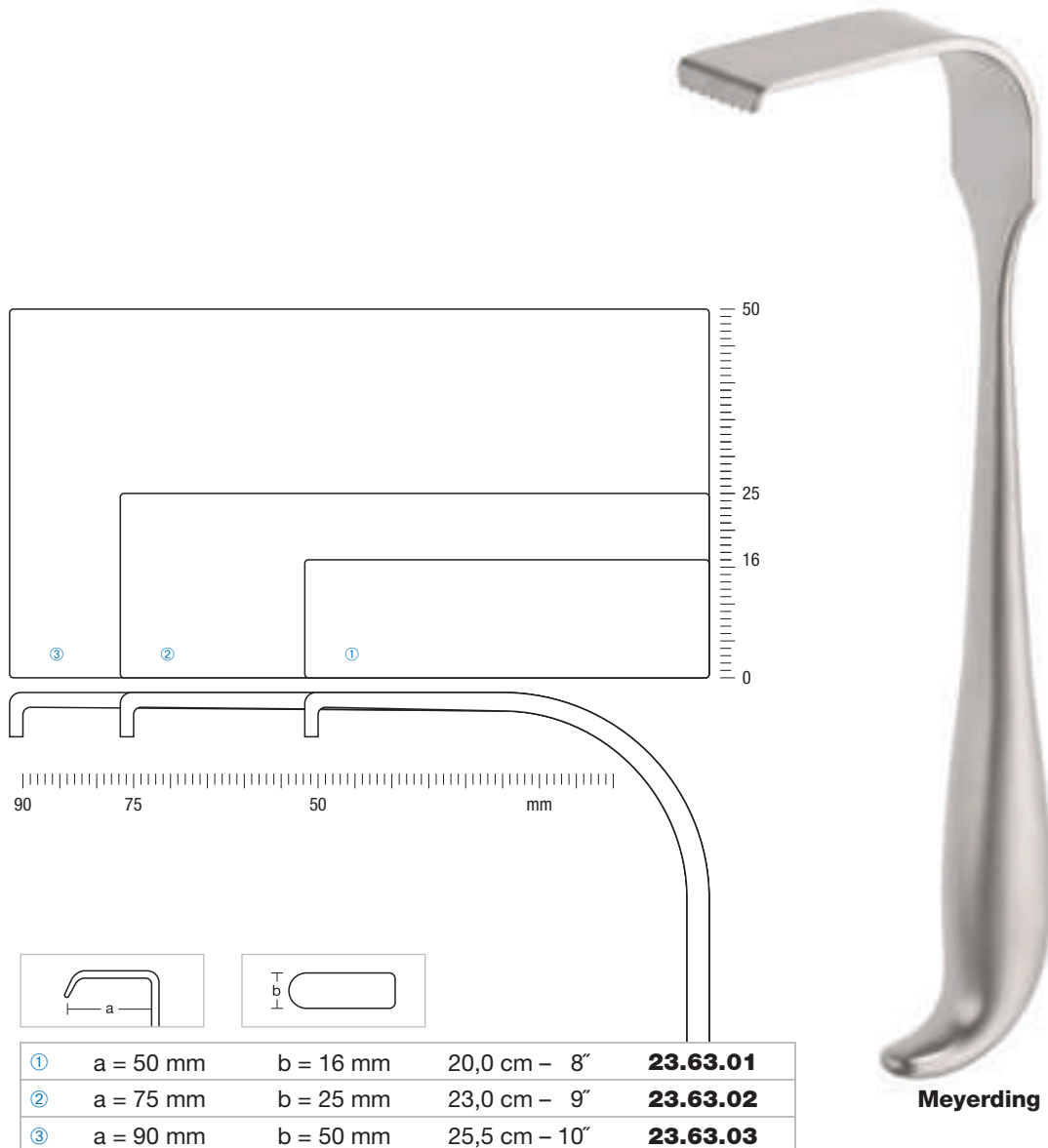



**Wundhaken
Retractors
Separadores
Ecarteurs
Divaricatori**

A08

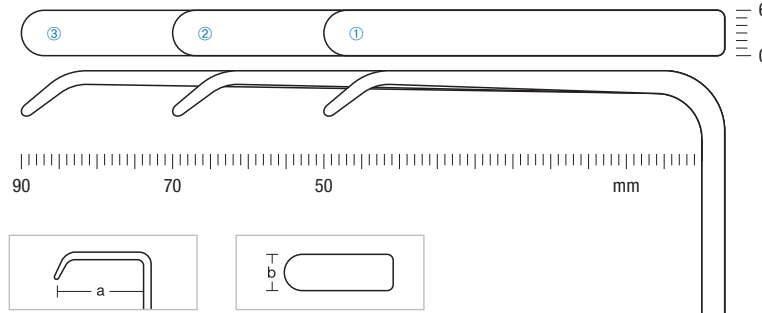

①	a = 50 mm	b = 6 mm	22 cm - 8 ³ / ₄ "	23.25.32
②	a = 70 mm	b = 6 mm	22 cm - 8 ³ / ₄ "	23.25.34
③	a = 90 mm	b = 6 mm	22 cm - 8 ³ / ₄ "	23.25.35



**Spinalhaken
Spinal retractors
Separadores espinales
Ecarteurs spinals
Divaricatori spinali**

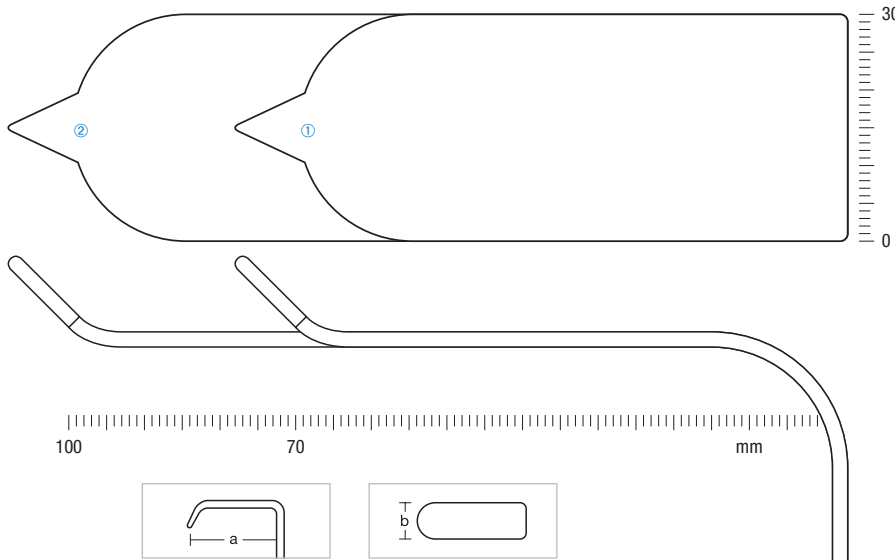

①	a = 70 mm	b = 30 mm	18 cm - 7 ¹ / ₈ "	57.54.07
②	a = 100 mm	b = 30 mm	18 cm - 7 ¹ / ₈ "	57.54.10

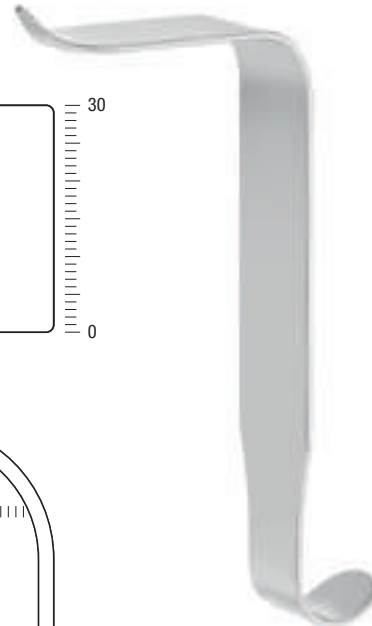

Taylor

Weichteilhaken mit gewölbtem Blatt
Soft tissue retractors with curved blade
Separadores para partes blandas con hoja abovedada
Ecarteurs pour parties molles avec lame courbée
Divaricatori per tessuti molli con valva convessa

①	a = 18 mm	b = 5 mm	22,5 cm – 9"	68.01.41
②	a = 25 mm	b = 7 mm	22,5 cm – 9"	68.01.42
③	a = 35 mm	b = 10 mm	22,5 cm – 9"	68.01.43
④	a = 42 mm	b = 10 mm	22,5 cm – 9"	68.01.44
⑤	a = 55 mm	b = 12 mm	22,5 cm – 9"	68.01.45
⑥	a = 70 mm	b = 14 mm	22,5 cm – 9"	68.01.46
⑦	a = 80 mm	b = 16 mm	22,5 cm – 9"	68.01.47

Obwegeser



Blatt, gewölbt
Blade, curved
Hoja, abovedada
Lame, courbée
Valva, convessa



Wundspreizer
Self-retaining Retractors
Separadores autoestáticos
Ecarteurs autostatiques
Divaricatori autostatici

A08



Weitlaner

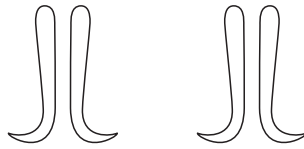

a = 18 mm 13 cm - 5 1/8"	a = 18 mm 16,5 cm - 6 1/2"
24.22.13	24.22.16

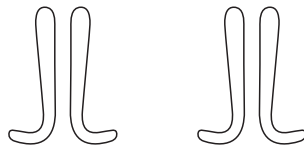

a = 18 mm 13 cm - 5 1/8"	a = 18 mm 16,5 cm - 6 1/2"
24.22.14	24.22.17

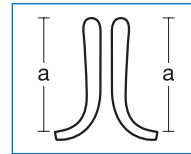

Weitlaner

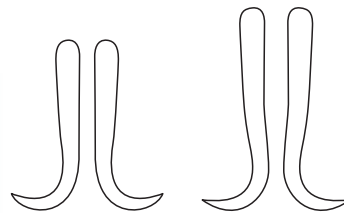

a = 20 mm 20 cm - 8"	a = 25 mm 24 cm - 9 1/2"
24.22.20	24.22.24

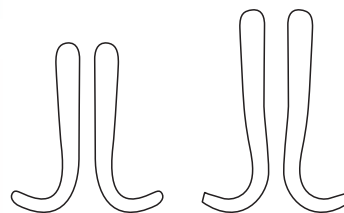

a = 20 mm 20 cm - 8"	a = 25 mm 24 cm - 9 1/2"
24.22.21	24.22.25

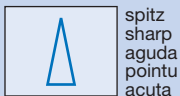
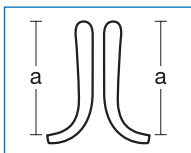

spitz
sharp
aguda
pointu
acuta



stumpf
blunt
roma
mousse
smussa

Wundspreizer
Self-retaining Retractors
Separadores autoestáticos
Ecarteurs autostatiques
Divaricatori autostatici

A08



Weitlaner

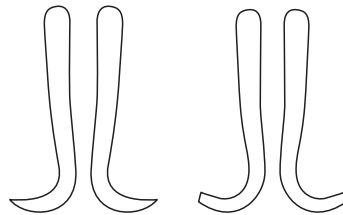

a = 25 mm
 25,5 cm - 10"

24.22.26



a = 25 mm
 25,5 cm - 10"

24.22.27

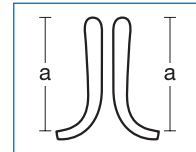

Miskimon

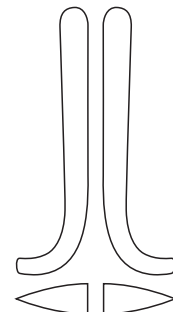

a = 33 mm
 22 cm - 8³/₄"

24.28.10

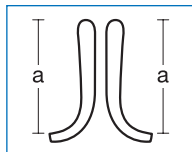

spitz
 sharp
 aguda
 pointu
 acuta



stumpf
 blunt
 roma
 mousse
 smussa



Wundspreizer
Self-retaining Retractors
Separadores autoestáticos
Ecarteurs autostatiques
Divaricatori autostatici

A08

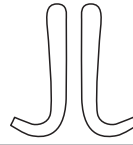
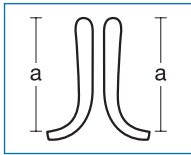

a = 16 mm
14 cm - 5½"

24.26.70



Contour

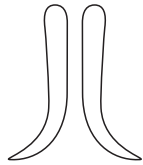

a = 20 mm
20 cm - 8"

24.28.01



Adson

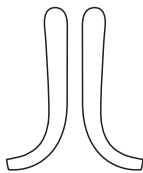

a = 20 mm
20 cm - 8"

24.28.03



Adson-Anderson

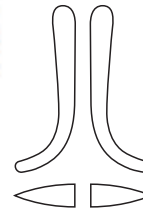

a = 20 mm
19 cm - 7½"

24.28.02



spitz
sharp
aguda
pointu
acuta



stumpf
blunt
roma
mousse
smussa

Wundspreizer
Self-retaining Retractors
Separadores autoestáticos
Ecarteurs autostatiques
Divaricatori autostatici

A08



Weitlaner-Beckmann

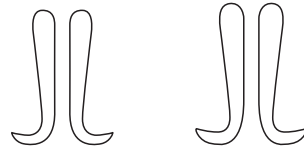

a = 16 mm 14,5 cm – 5 ³ / ₈ " 24.30.13	a = 17 mm 17 cm – 6 ³ / ₄ " 24.30.16
---	---

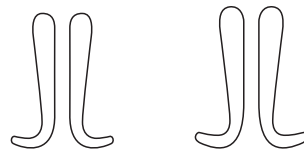

a = 16 mm 14,5 cm – 5 ³ / ₈ " 24.30.14	a = 17 mm 17 cm – 6 ³ / ₄ " 24.30.17
---	---

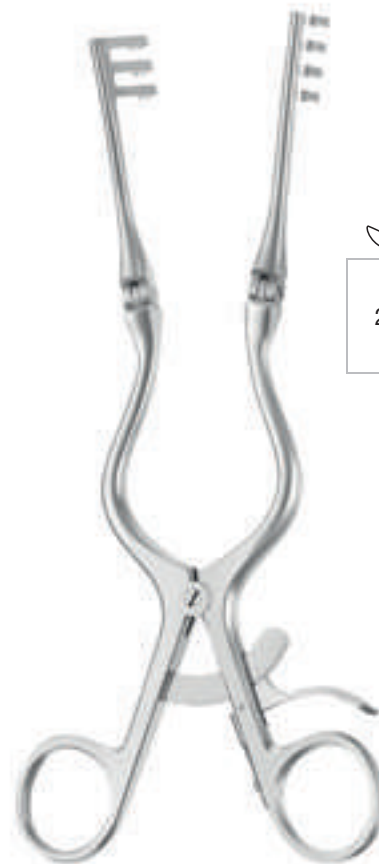
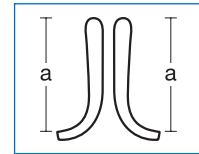

Weitlaner-Beckmann

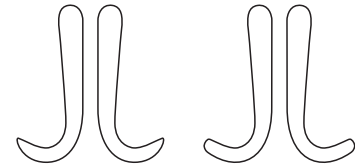

a = 19 mm 22 cm – 8 ³ / ₄ " 24.30.20	a = 19 mm 22 cm – 8 ³ / ₄ " 24.30.21
---	---

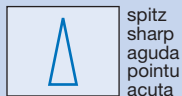
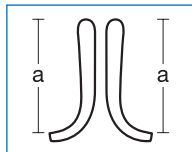

spitz
sharp
aguda
pointu
acuta



stumpf
blunt
roma
mousse
smussa



A08

Wundspreizer
Self-retaining Retractors
Separadores autoestáticos
Ecarteurs autostatiques
Divaricatori autostatici

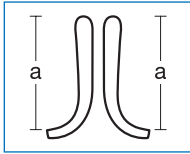

Beckmann

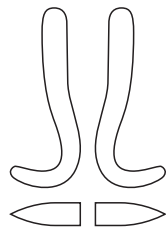

a = 21 mm
31 cm - 12 1/8"
24.32.04



Adson

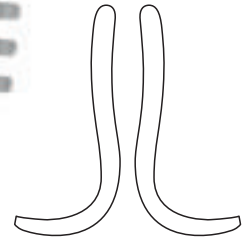

a = 28 mm
32,5 cm - 12 3/4"
24.32.06



spitz
sharp
aguda
pointu
acuta



stumpf
blunt
roma
mousse
smussa

Wundspreizer
Self-retaining Retractors
Separadores autoestáticos
Ecarteurs autostatiques
Divaricatori autostatici

A08

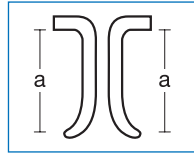

Beckmann-Adson

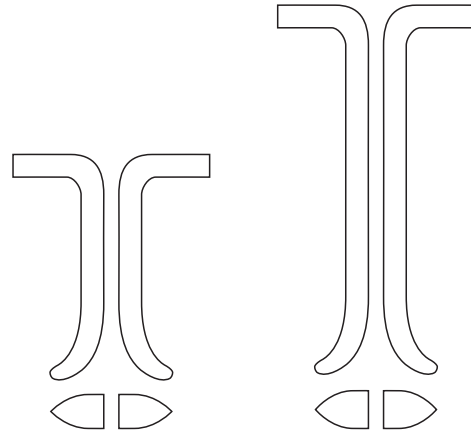

a = 25 mm 31 cm – 12 1/8"	a = 44 mm 31 cm – 12 1/8"
24.34.25	24.34.45

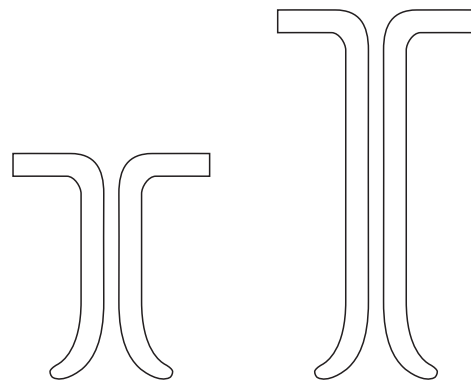

a = 25 mm 31 cm – 12 1/8"	a = 44 mm 31 cm – 12 1/8"
24.34.26	24.34.46



spitz
sharp
aguda
pointu
acuta



stumpf
blunt
roma
mousse
smussa



A08

Wundspreizer
Self-retaining Retractors
Separadores autoestáticos
Ecarteurs autostatiques
Divaricatori autostatici



Beckmann-Eaton

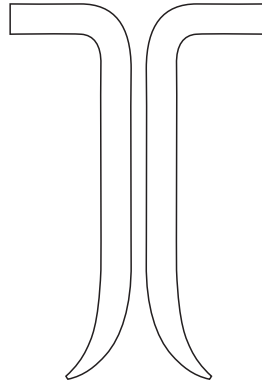

a = 45 mm
32 cm – 12½"
24.34.50

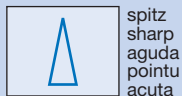
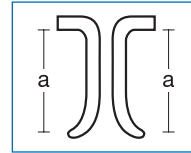

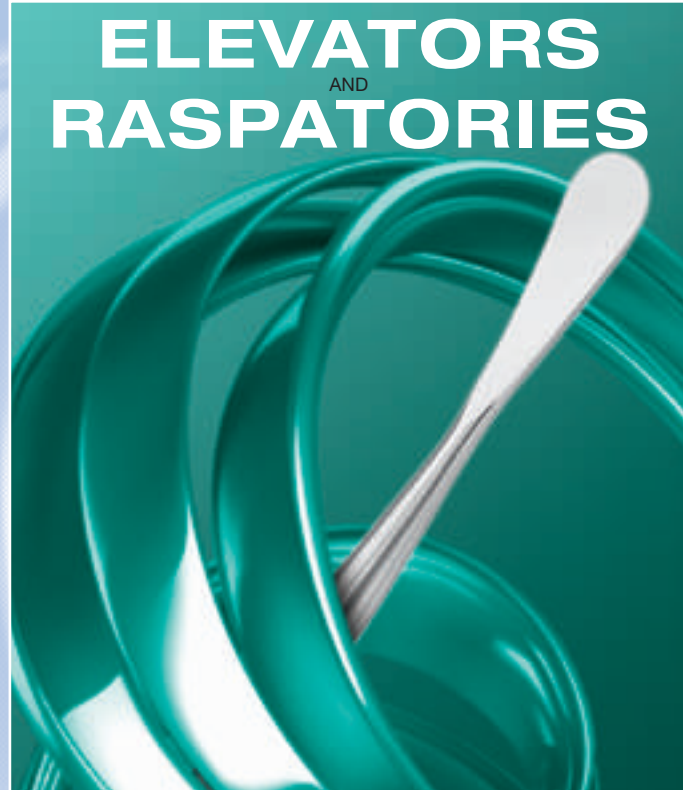

MICRO RASPATORIES

Mikro-Raspatorien (siehe Seite 295-297)
 Micro raspatories (see page 295-297)
 Micro legras (véase página 295-297)
 Micro rugines (voir page 295-297)
 Micro periostotomi (vedi pagina 295-297)



Elevatoren und Raspatorien
Elevators and Raspatories
Elevadores y legras
Elévateurs et rugines
Elevatori e periostotomi

A09

6 mm

17 cm – 6¾"

26.48.02



Adson



5 mm





6,5 mm

19 cm – 7½"

26.35.02

19 cm – 7½"

26.35.03

5 mm

6,5 mm

Freer



5 mm

19 cm – 7½"

26.35.01



Freer



3 mm

5 mm

7 mm

16 cm – 6¼"

26.42.03

16 cm – 6¼"

26.42.05

16 cm – 6¼"

26.42.07

Williger

Raspatorien
 Raspatories
 Legras
 Rugines
 Periostotomi



scharf
 sharp
 cortante
 tranchant
 tagliente



stumpf
 blunt
 roma
 mousse
 smussa

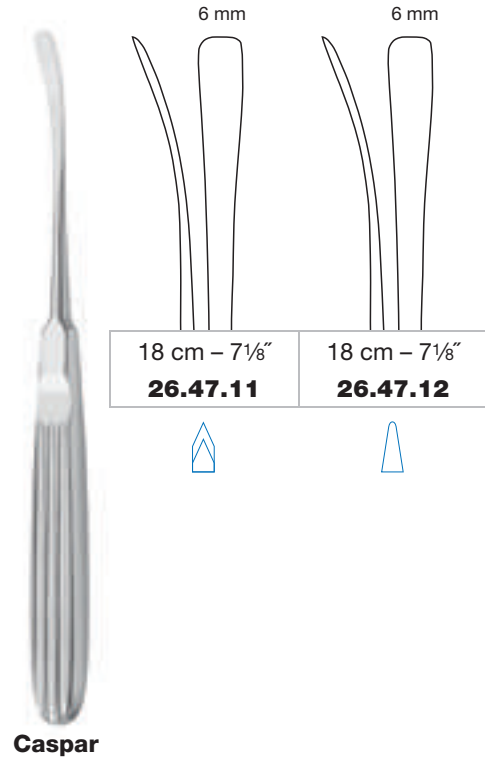
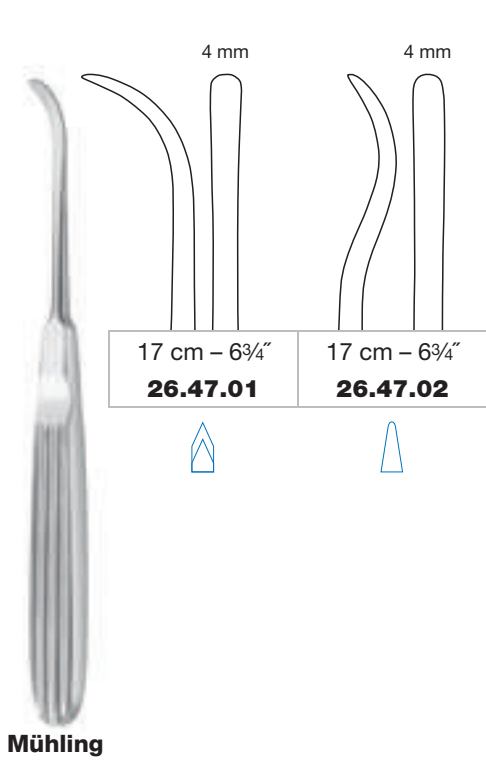

**MICRO
RASPATORIES**

Mikro-Raspatorien (siehe Seite 295-297)
 Micro raspatories (see page 295-297)
 Micro legras (véase página 295-297)
 Micro rugines (voir page 295-297)
 Micro periostotomi (vedi pagina 295-297)

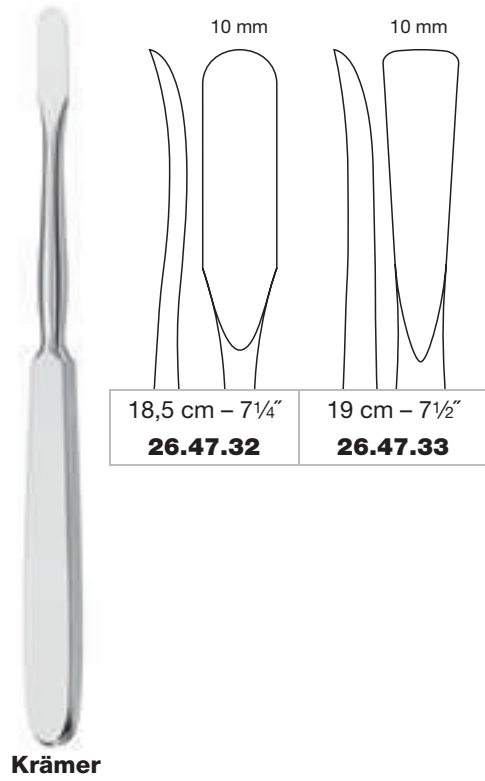



Raspatorien
Raspatories
Legras
Rugines
Periostotomi

A09



Sedillot



Sedillot

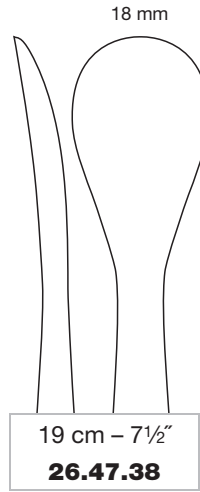

Adson

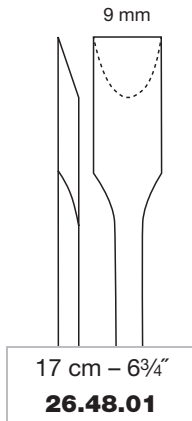

Adson

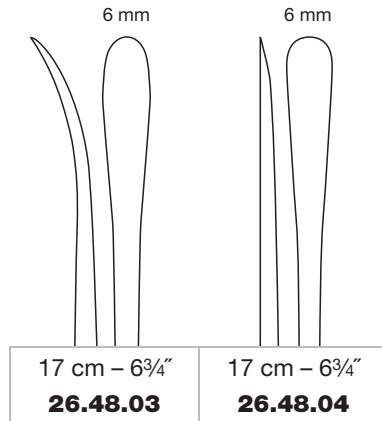



Cushing

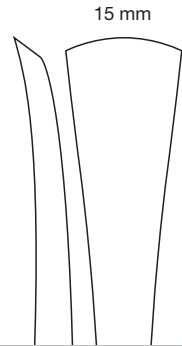

15 mm

18 cm - 7 1/8"
26.62.01

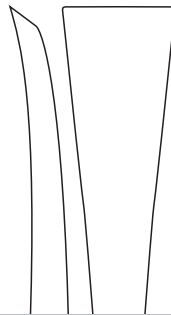

15 mm

18 cm - 7 1/8"
26.62.02

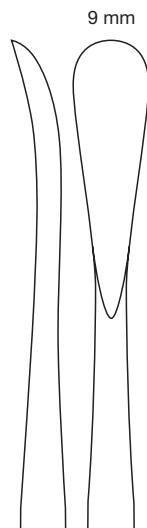

9 mm

28 cm - 11"
26.73.09



13 mm

28 cm - 11"
26.73.13

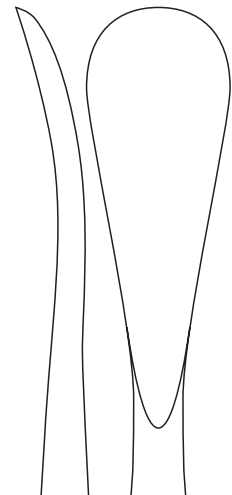

20 mm

28 cm - 11"
26.73.19



Raspatorien
Raspatories
Legras
Rugines
Periostotomi

A09



PROPYLUX

- ▶ Ein biokompatibler Kunststoff der neuesten Thermoplast-Generation
- ▶ Extrem formbeständig bei häufiger Autoklavierung
- ▶ A biocompatible plastic from the latest generation of thermoplastics
- ▶ Extremely high dimensional stability even when frequently autoclaved
- ▶ Un plástico biocompatible de la última generación de termoplásticos
- ▶ Extremadamente resistente a deformaciones en esterilizaciones en autoclave frecuentes
- ▶ Un plastique biocompatible de la toute dernière génération des thermoplastiques
- ▶ Extrêmement résistant aux déformations en cas de passages fréquents à l'autoclave
- ▶ Una plastica biocompatibile della più recente generazione di termoplastiche
- ▶ Estremamente resistente a deformazioni anche con trattamento frequente in autoclave



NOVOTEX

- ▶ Ein duroplastischer Kunststoff aus der Familie der Phenoplaste
- ▶ Sehr hart und bruchbeständig
- ▶ Thermosetting plastics of the range of phenol formaldehyde resins
- ▶ Very hard and break resistant
- ▶ Plástico termoendurecible de la familia de resina fenol-formaldehído
- ▶ Muy duro y resistente a la rotura
- ▶ Plastique thermodurcissable de la famille des résines phénol-formaldéhyde
- ▶ Très dur et résistant à la casse
- ▶ Materia plastica termoindurente della famiglia di resine fenoliche
- ▶ Molto duro e resistente alla rottura

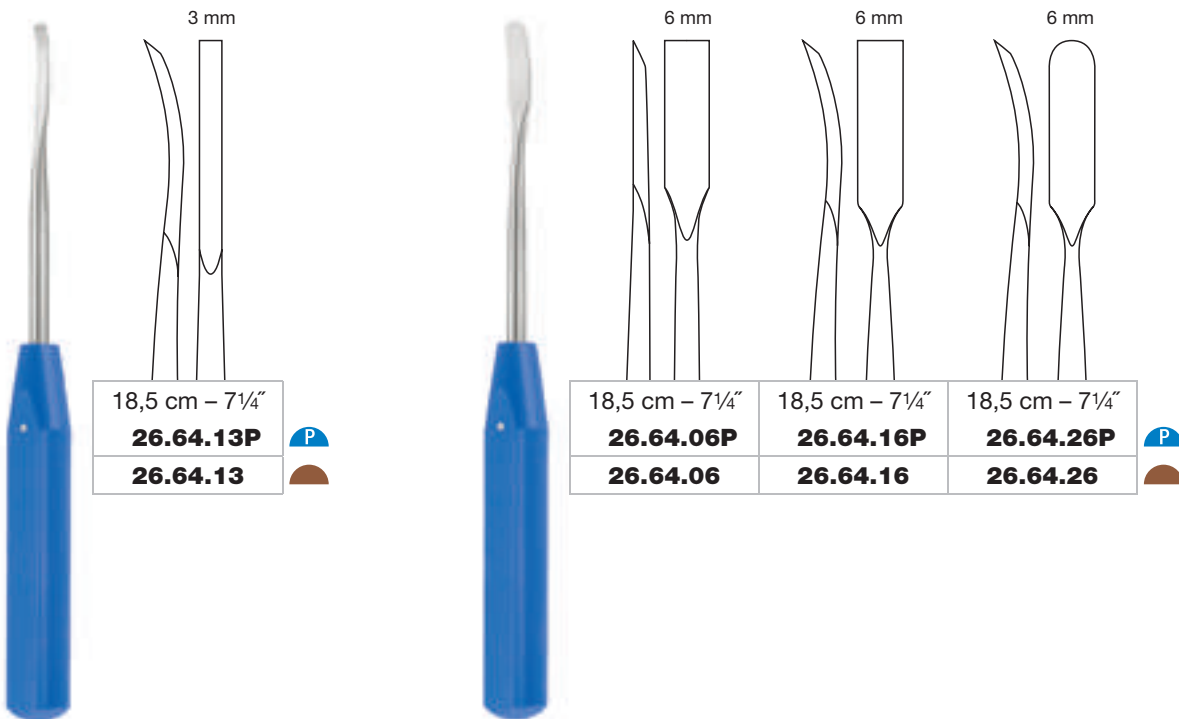

Kunststoffgriff (autoklavierbar bis 134 °C bei 3 bar)
 Plastic handle (autoclavable up to 134 °C at 3 bar)
 Mango de plástico (autoclavable hasta 134 °C bajo presión de 3 bar)
 Manche en plastique (autoclavable à 134 °C sous pression de 3 bars)
 Manico di plastica (autoclavabile fino a 134 °C sotto pressione di 3 bar)

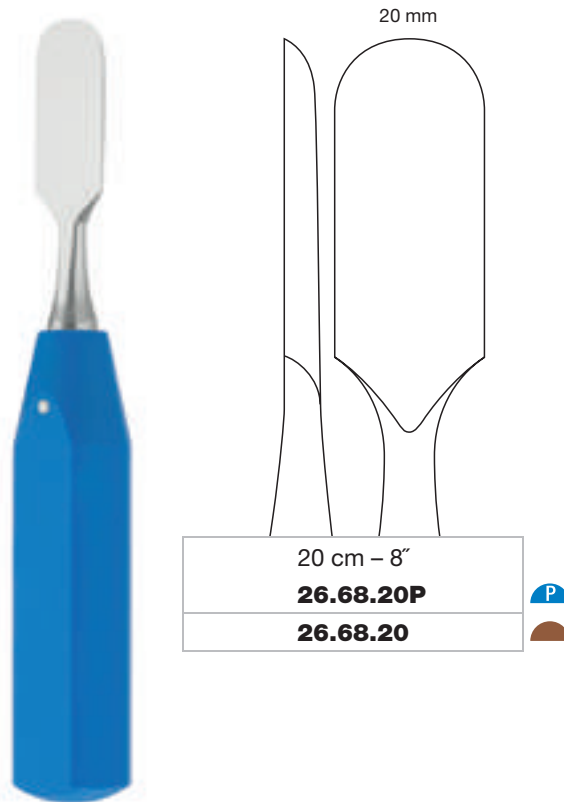
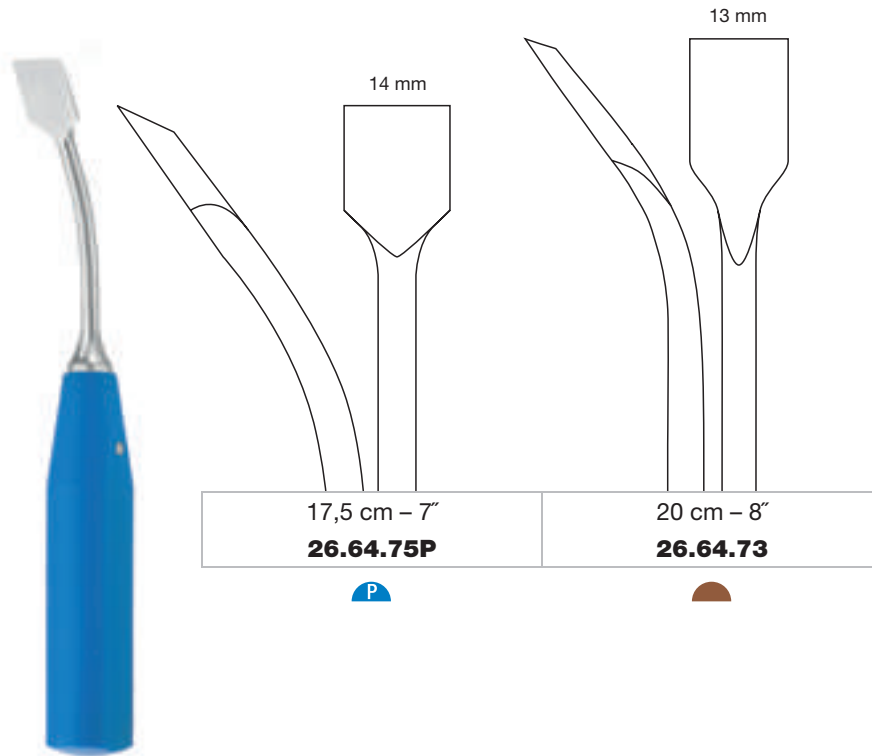

Kunststoffgriff (autoklavierbar bis 134 °C bei 3 bar)
 Plastic handle (autoclavable up to 134 °C at 3 bar)
 Mango de plástico (autoclavable hasta 134 °C bajo presión de 3 bar)
 Manche en plastique (autoclavable à 134 °C sous pression de 3 bars)
 Manico di plastica (autoclavabile fino a 134 °C sotto pressione di 3 bar)



Raspatorien
Raspatories
Legras
Rugines
Periostotomi

A09

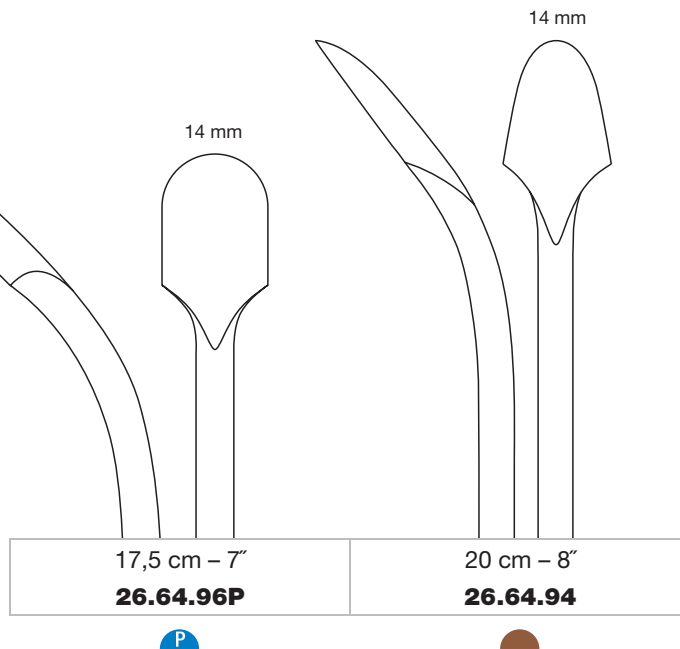
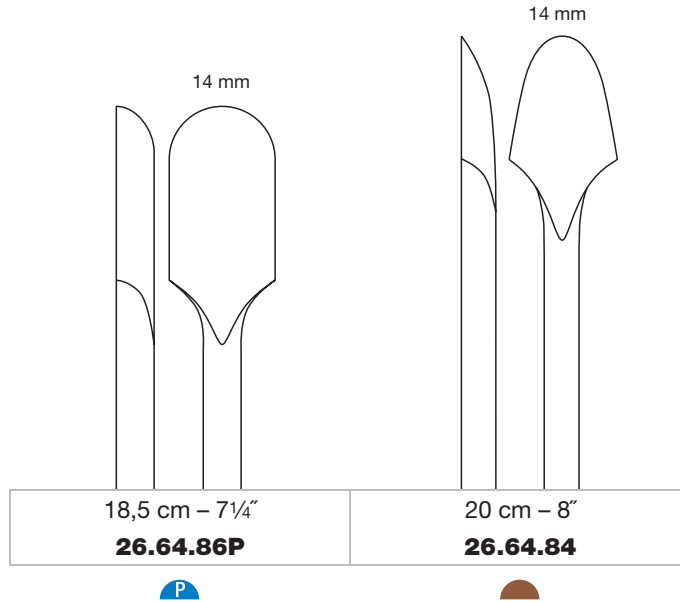

Kunststoffgriff (autoklavierbar bis 134 °C bei 3 bar)
 Plastic handle (autoclavable up to 134 °C at 3 bar)
 Mango de plástico (autoclavable hasta 134 °C bajo presión de 3 bar)
 Manche en plastique (autoclavable à 134 °C sous pression de 3 bars)
 Manico di plastica (autoclavabile fino a 134 °C sotto pressione di 3 bar)



Cobb

10 mm



25 cm – 10"

26.65.10P

26.65.10



13 mm



25 cm – 10"

26.65.13P

26.65.13



19 mm

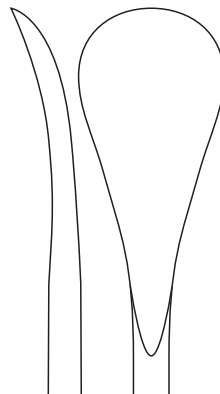

25 cm – 10"

26.65.19P

26.65.19



25 mm

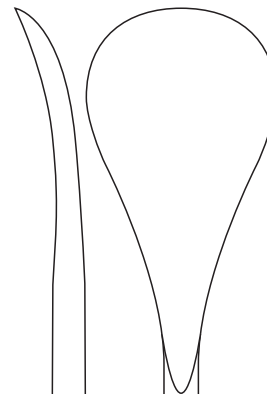

25 cm – 10"

26.65.25P

26.65.25





Raspatorien
Raspatories
Legras
Rugines
Periostotomi

A09

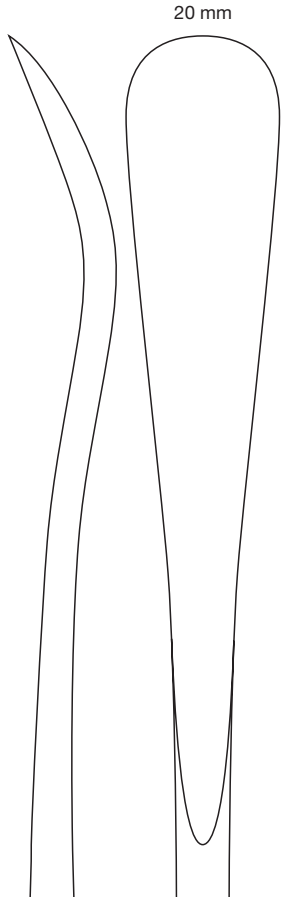

28 cm – 11"
26.67.27P
26.67.27



Wagner

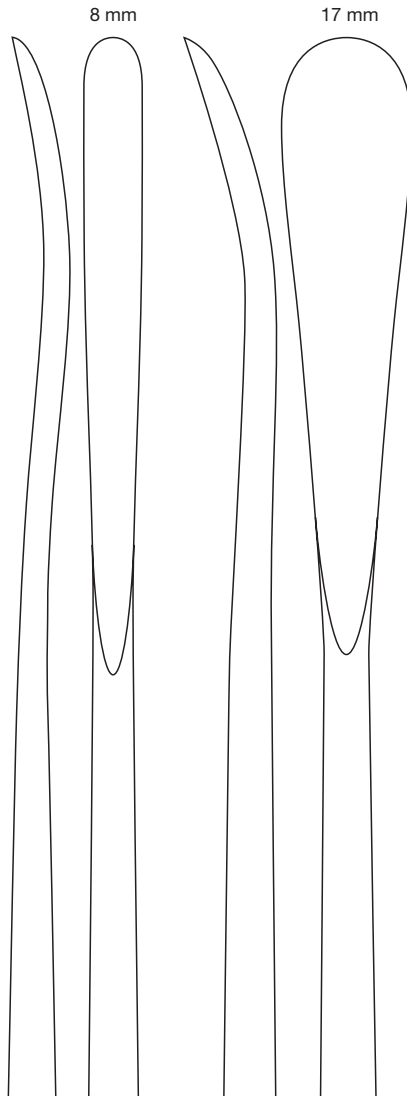

33 cm – 13"
26.67.33P
26.67.33

33 cm – 13"
26.67.34P
26.67.34



Kunststoffgriff (autoklavierbar bis 134 °C bei 3 bar)
Plastic handle (autoclavable up to 134 °C at 3 bar)
Mango de plástico (autoclavable hasta 134 °C bajo presión de 3 bar)
Manche en plastique (autoclavable à 134 °C sous pression de 3 bars)
Manico di plastica (autoclavabile fino a 134 °C sotto pressione di 3 bar)

**Hämmer, Stößel, Meißel und Löffel
Mallets, Pestles, Chisels and Curettes
Martillos, pisón, cinceles y cucharillas
Maillets, pilon, ciseaux burins et curettes
Martelli, pestone, scalpelli e cucchiari**

A10

Mallets/Chisels

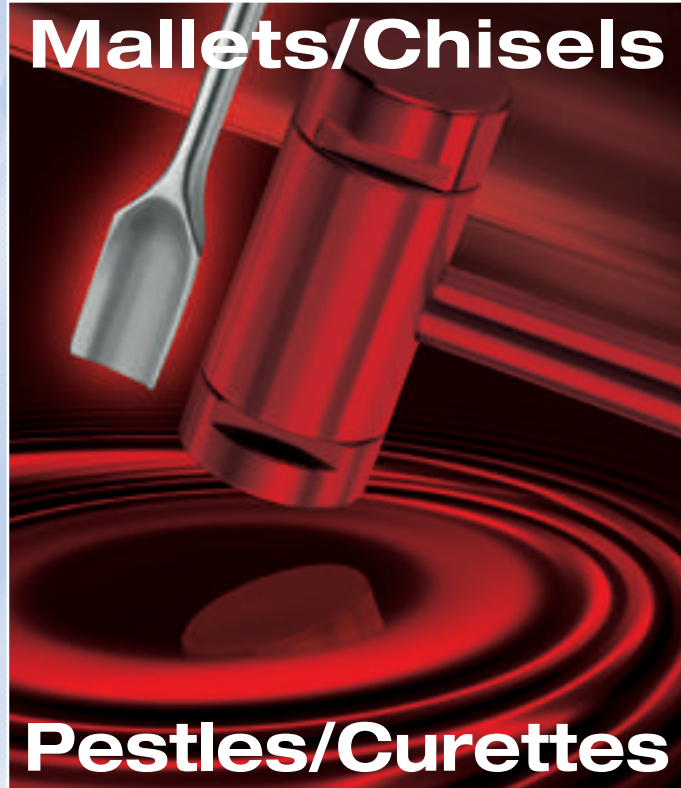

Pestles/Curettes

**A10**

Hämmer
Mallets
Martillos
Maillets
Martelli

mit Kunststoffbacken (abschraubbar)
 with plastic discs (unscrewable)
 con frentes de material plástico (destornillables)
 avec joues en matière plastique (dévissables)
 con guancie di plastica (svitabili)

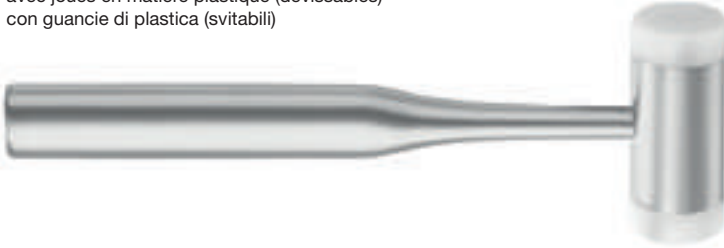

18,5 cm – 7¼"	27.06.20	200 g	Ø 25 mm
---------------	-----------------	-------	---------

27.06.21

Ersatzbacken, Paar
 Replacement discs, pair
 Frentes de repuesto, par
 Jous de rechange, paire
 Guancie di ricambio, paio



19 cm – 7½"	27.09.19	215 g	Ø 19 mm
-------------	-----------------	-------	---------

23 cm – 9"	27.09.25	350 g	Ø 25 mm
------------	-----------------	-------	---------

Besonders geeignet bei Opera-
 tionen an der Halswirbelsäule

Particularly useful in operations of
 the cervical vertebral column

Particolarmente apropiado para
 operaciones a las vertebra
 cervicales

Se prêtant avantageusement aux
 opérations des vertèbres cervicales

Particolarmente adatto per
 interventi alle vertebre cervicali

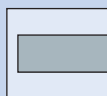

19 cm – 7½"	67.40.20	300 g	Ø 30 mm
-------------	-----------------	-------	---------

Cottle

Plan
 Plane
 Plano
 Piano
 Piano

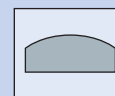

Konvex
 Convex
 Convexo
 Convexo
 Convesso

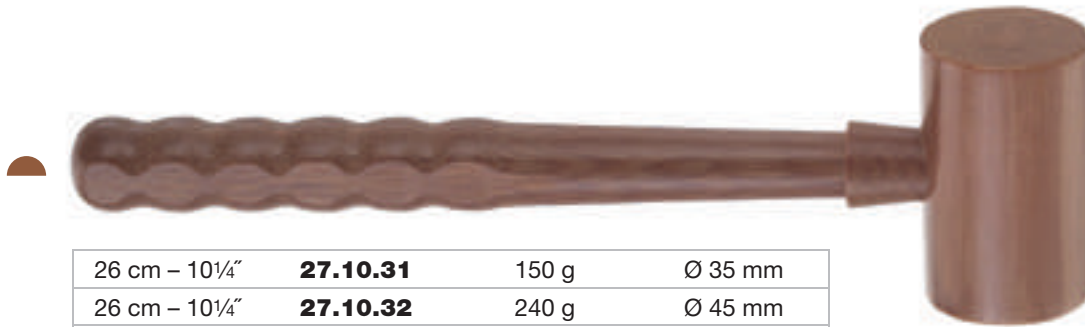

26 cm – 10¼"	27.10.31	150 g	Ø 35 mm
26 cm – 10¼"	27.10.32	240 g	Ø 45 mm
26 cm – 10¼"	27.10.33	330 g	Ø 50 mm



Bleigefüllt
Lead filled head
Relleno de plomo
Rempli de plomb
Pieno di piombo

Steinbach

24 cm – 9½"	27.10.35	400 g	Ø 60 mm
-------------	-----------------	-------	---------



27.10.51

Ersatzbacken, Paar
Replacement discs, pair
Frentes de repuesto, par
Joues de rechange, paire
Guancie di ricambio, paio

24 cm – 9½"	27.10.50	380 g	Ø 30 mm
-------------	-----------------	-------	---------



27.10.61

Ersatzbacken, Paar
Replacement discs, pair
Frentes de repuesto, par
Joues de rechange, paire
Guancie di ricambio, paio

24 cm – 9½"	27.10.60	360 g	Ø 37 mm
-------------	-----------------	-------	---------



Kunststoff (autoklavierbar bis 134 °C bei 3 bar)
Plastic (autoclavable up to 134 °C at 3 bar)
Plástico (autoclavable hasta 134 °C bajo presión de 3 bar)
Plastique (autoclavable à 134 °C sous pression de 3 bars)
Plastica (autoclavabile fino a 134 °C sotto pressione di 3 bar)



Hämmer
Mallets
Martillos
Maillets
Martelli

A10

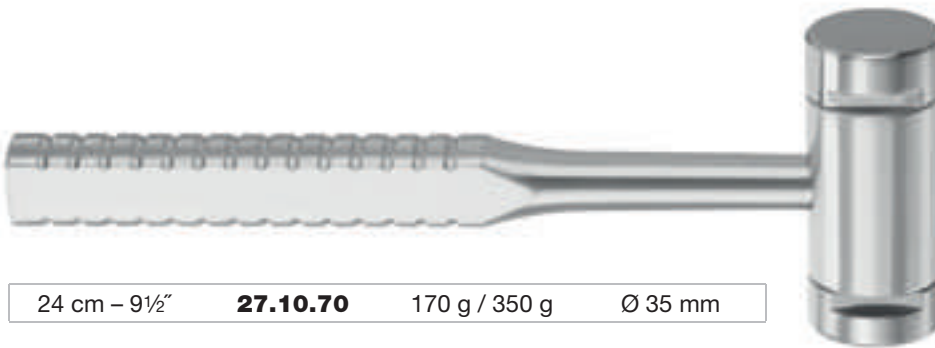

24 cm – 9½" **27.10.70** 170 g / 350 g Ø 35 mm

Satz bestehend aus: Set consisting of: Juego compuesto por: Jeu composé de: Set composto da:	27.10.71 Metallbacken, plan/konvex Metal discs, plane/convex Frentes de metal, plano/convexo Jous métalliques, plane/convexe Guancie d'acciaio, piano/convesso	2x	110 g + 130 g + 110 g
	27.10.72 Kunststoffbacken, plan/konvex Plastic discs, plane/convex Frentes de plástico, plano/convexo Jous en plastique, plane/convexe Guancie di plastica, piano/convesso	2x	20 g + 130 g + 20 g
	27.10.73 Gabelschlüssel Fork wrench Llave horquilla Clé Chiave a forcina	1x	

Metallbacken
 Metal discs
 Frentes de metal
 Jous métalliques
 Guancie d'acciaio

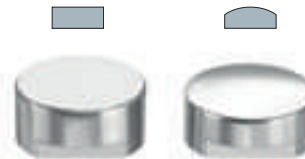

Ø 35 mm **27.10.71** 220 g

Kunststoffbacken
 Plastic discs
 Frentes de plástico
 Jous en plastique
 Guancie di plastica



Ø 35 mm **27.10.72** 40 g

Gabelschlüssel
 Fork wrench
 Llave horquilla
 Clé
 Chiave a forcina



27.10.73

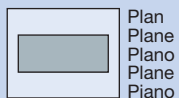

Plan
 Plane
 Plano
 Plane
 Piano

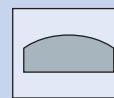

Konvex
 Convex
 Convexo
 Convexe
 Convesso





PROPYLUX

- ▶ Ein biokompatibler Kunststoff der neuesten Thermoplast-Generation
- ▶ Extrem formbeständig bei häufiger Autoklavierung
- ▶ A biocompatible plastic from the latest generation of thermoplastics
- ▶ Extremely high dimensional stability even when frequently autoclaved
- ▶ Un plástico biocompatible de la última generación de termoplásticos
- ▶ Extremadamente resistente a deformaciones en esterilizaciones en autoclave frecuentes
- ▶ Un plastique biocompatible de la toute dernière génération des thermoplastiques
- ▶ Extrêmement résistant aux déformations en cas de passages fréquents à l'autoclave
- ▶ Una plastica biocompatibile della più recente generazione di termoplastiche
- ▶ Estremamente resistente a deformazioni anche con trattamento frequente in autoclave



NOVOTEX

- ▶ Ein duroplastischer Kunststoff aus der Familie der Phenoplaste
- ▶ Sehr hart und bruchbeständig
- ▶ Thermosetting plastics of the range of phenol formaldehyde resins
- ▶ Very hard and break resistant
- ▶ Plástico termoendurecible de la familia de resina fenol-formaldehído
- ▶ Muy duro y resistente a la rotura
- ▶ Plastique thermodurcissable de la famille des résines phénol-formaldéhyde
- ▶ Très dur et résistant à la casse
- ▶ Materia plastica termoindurente della famiglia di resine fenoliche
- ▶ Molto duro e resistente alla rottura

<p>Caspar</p>	<p>Ø 3 mm</p>	<p>20 cm – 8"</p> <p>27.95.15P </p> <p>27.95.15 </p>	<p>Caspar</p>	<p>Ø 12 mm</p>	<p>20 cm – 8"</p> <p>27.95.20P </p> <p>27.95.20 </p>
	<p>Ø 5 mm</p>	<p>20 cm – 8"</p> <p>27.95.16P </p> <p>27.95.16 </p>		<p>Ø 14 mm</p>	<p>20 cm – 8"</p> <p>27.95.21P </p> <p>27.95.21 </p>
	<p>Ø 8 mm</p>	<p>20 cm – 8"</p> <p>27.95.17P </p> <p>27.95.17 </p>		<p>Ø 16 mm</p>	<p>20 cm – 8"</p> <p>27.95.22P </p> <p>27.95.22 </p>



Kunststoffgriff (autoklavierbar bis 134 °C bei 3 bar)
 Plastic handle (autoclavable up to 134 °C at 3 bar)
 Mango de plástico (autoclavable hasta 134 °C bajo presión de 3 bar)
 Manche en plastique (autoclavable à 134 °C sous pression de 3 bars)
 Manico di plastica (autoclavabile fino a 134 °C sotto pressione di 3 bar)



Flachmeißel
Chisels
Cinceles
Ciseaux burins
Scalpelli

A10



Mini-Lexer

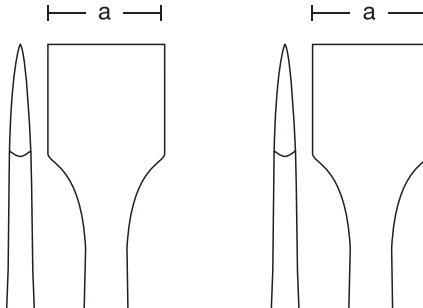

	18 cm – 7 ¹ / ₈ "	18 cm – 7 ¹ / ₈ "
a = 2 mm	28.61.02P	28.61.02
a = 4 mm	28.61.04P	28.61.04
a = 6 mm	28.61.06P	28.61.06
a = 8 mm	28.61.08P	28.61.08
a = 10 mm	28.61.10P	28.61.10
a = 12 mm	28.61.12P	28.61.12
a = 15 mm	28.61.15P	28.61.15
a = 20 mm	28.61.20P	28.61.20

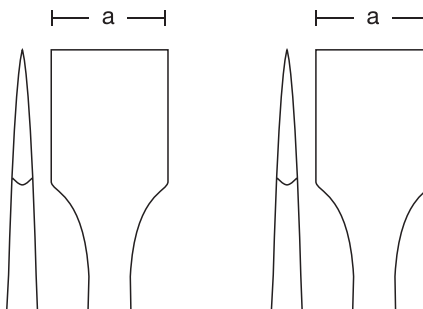

	22 cm – 8 ³ / ₄ "	22 cm – 8 ³ / ₄ "
a = 7 mm	28.64.07P	28.64.07
a = 10 mm	28.64.10P	28.64.10
a = 12 mm	28.64.12P	28.64.12
a = 15 mm	28.64.15P	28.64.15
a = 20 mm	28.64.20P	28.64.20
a = 25 mm	28.64.25P	28.64.25
a = 30 mm	28.64.30P	28.64.30



Lexer



Kunststoffgriff (autoklavierbar bis 134 °C bei 3 bar)
 Plastic handle (autoclavable up to 134 °C at 3 bar)
 Mango de plástico (autoclavable hasta 134 °C bajo presión de 3 bar)
 Manche en plastique (autoclavable à 134 °C sous pression de 3 bars)
 Manico di plastica (autoclavabile fino a 134 °C sotto pressione di 3 bar)



Dahmen

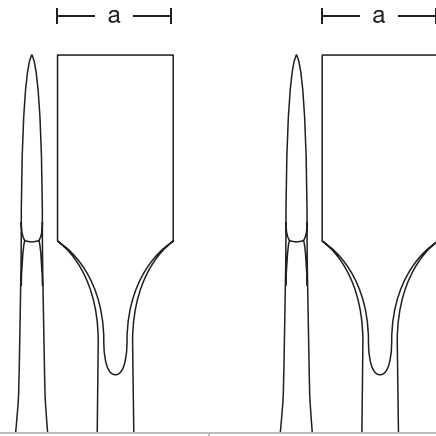

	30 cm – 11 ³ / ₄ "	30 cm – 11 ³ / ₄ "
a = 6 mm	28.66.06P	28.66.06
a = 8 mm	28.66.08P	28.66.08
a = 10 mm	28.66.10P	28.66.10
a = 12 mm	28.66.12P	28.66.12
a = 15 mm	28.66.15P	28.66.15
a = 20 mm	28.66.20P	28.66.20
a = 22 mm	28.66.22P	28.66.22
a = 25 mm	28.66.25P	28.66.25



Kunststoffgriff (autoklavierbar bis 134 °C bei 3 bar)
 Plastic handle (autoclavable up to 134 °C at 3 bar)
 Mango de plástico (autoclavable hasta 134 °C bajo presión de 3 bar)
 Manche en plastique (autoclavable à 134 °C sous pression de 3 bars)
 Manico di plastica (autoclavabile fino a 134 °C sotto pressione di 3 bar)



Hohlmeißel
Gouges
Gubias
Gouges
Sgorbie

A10



Mini-Lexer

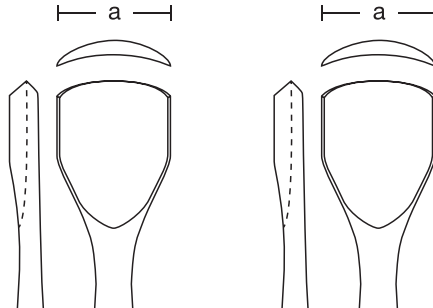

	18 cm - 7 $\frac{1}{8}$ "	18 cm - 7 $\frac{1}{8}$ "
a = 2 mm	28.62.02P	28.62.02
a = 4 mm	28.62.04P	28.62.04
a = 6 mm	28.62.06P	28.62.06
a = 8 mm	28.62.08P	28.62.08
a = 10 mm	28.62.10P	28.62.10
a = 12 mm	28.62.12P	28.62.12
a = 15 mm	28.62.15P	28.62.15
a = 20 mm	28.62.20P	28.62.20

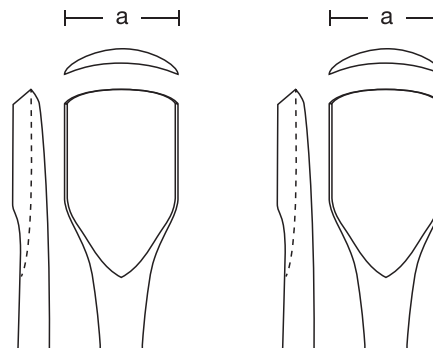

	22 cm - 8 $\frac{3}{4}$ "	22 cm - 8 $\frac{3}{4}$ "
a = 7 mm	28.65.07P	28.65.07
a = 10 mm	28.65.10P	28.65.10
a = 12 mm	28.65.12P	28.65.12
a = 15 mm	28.65.15P	28.65.15
a = 20 mm	28.65.20P	28.65.20
a = 25 mm	28.65.25P	28.65.25
a = 30 mm	28.65.30P	28.65.30



Lexer



Kunststoffgriff (autoklavierbar bis 134 °C bei 3 bar)
 Plastic handle (autoclavable up to 134 °C at 3 bar)
 Mango de plástico (autoclavable hasta 134 °C bajo presión de 3 bar)
 Manche en plastique (autoclavable à 134 °C sous pression de 3 bars)
 Manico di plastica (autoclavabile fino a 134 °C sotto pressione di 3 bar)



Lexer

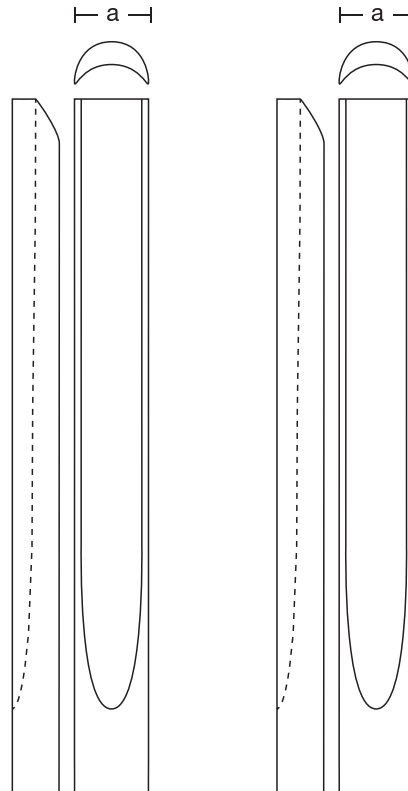

	25 cm - 10"	25 cm - 10"
a = 5 mm	28.65.55P	28.65.55
a = 10 mm	28.65.60P	28.65.60
a = 15 mm	28.65.65P	28.65.65





Hohlmeißel
Gouges
Gubias
Gouges
Sgorbie

A10



Lexer

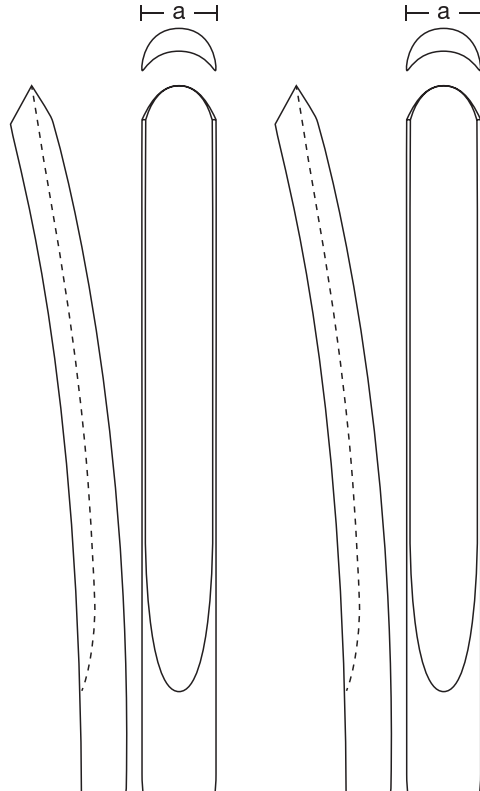

	25 cm - 10"	25 cm - 10"
a = 5 mm	28.65.75P	28.65.75
a = 10 mm	28.65.80P	28.65.80
a = 15 mm	28.65.85P	28.65.85



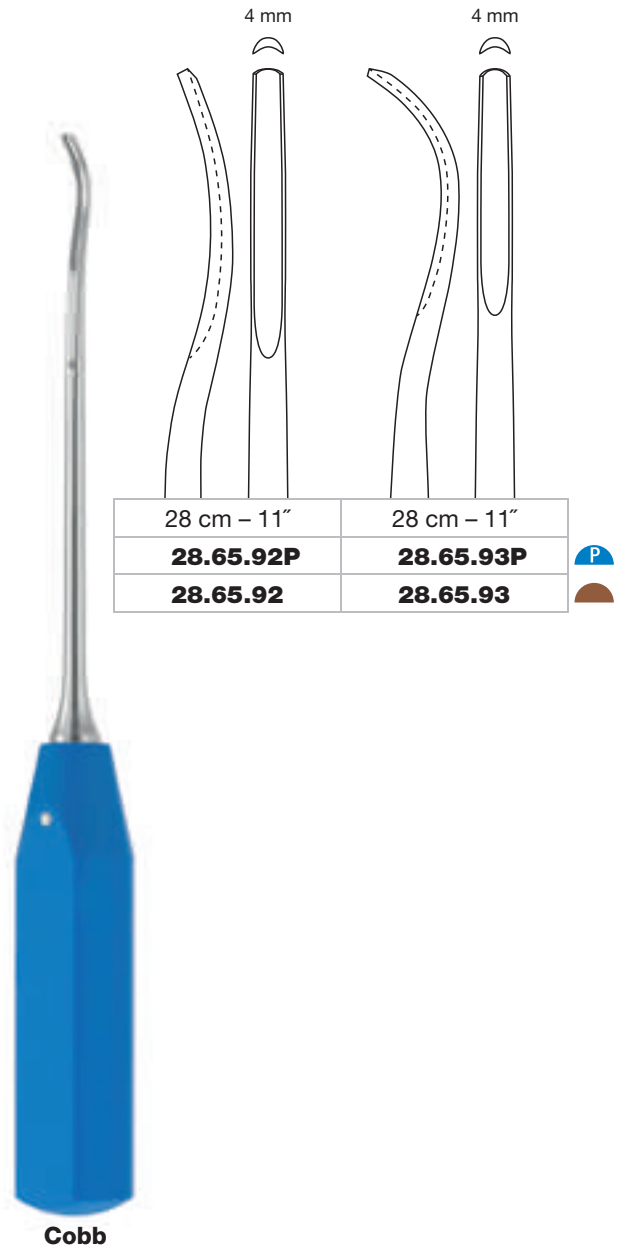
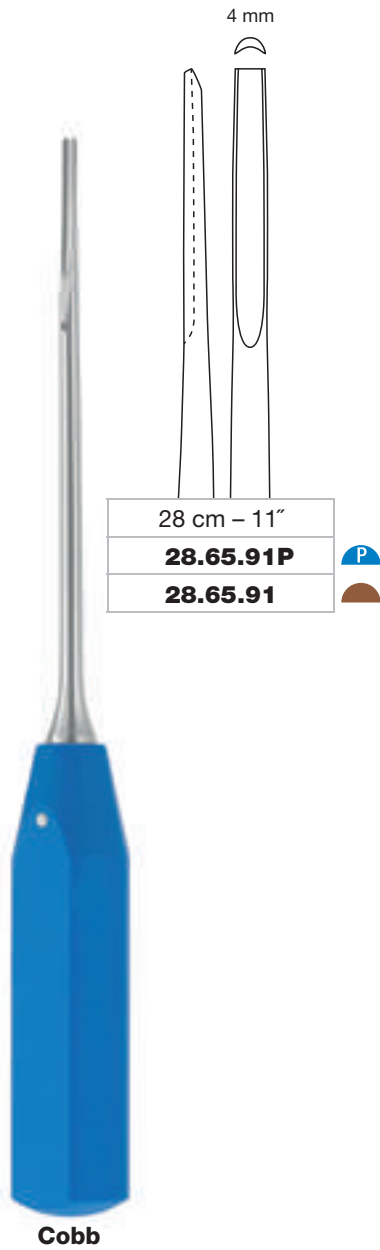



Hohlmeißel
Gouges
Gubias
Gouges
Sgorbie

A10



Dahmen

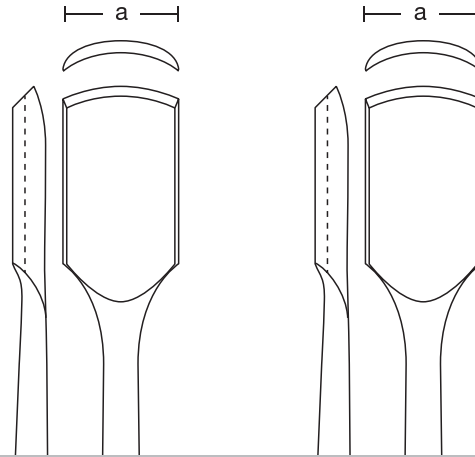

	30 cm – 11 $\frac{3}{4}$ "	30 cm – 11 $\frac{3}{4}$ "
a = 6 mm	28.67.06P	28.67.06
a = 8 mm	28.67.08P	28.67.08
a = 10 mm	28.67.10P	28.67.10
a = 12 mm	28.67.12P	28.67.12
a = 15 mm	28.67.15P	28.67.15
a = 20 mm	28.67.20P	28.67.20
a = 22 mm	28.67.22P	28.67.22
a = 25 mm	28.67.25P	28.67.25



Kunststoffgriff (autoklavierbar bis 134 °C bei 3 bar)
 Plastic handle (autoclavable up to 134 °C at 3 bar)
 Mango de plástico (autoclavable hasta 134 °C bajo presión de 3 bar)
 Manche en plastique (autoclavable à 134 °C sous pression de 3 bars)
 Manico di plastica (autoclavabile fino a 134 °C sotto pressione di 3 bar)



Dahmen

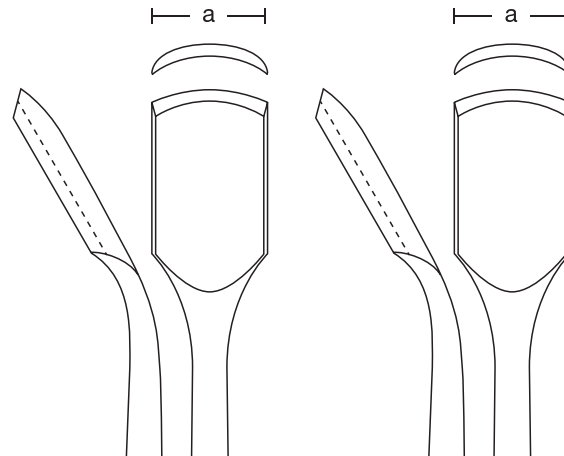

	30 cm – 11¾"	30 cm – 11¾"
a = 6 mm	28.67.36P	28.67.36
a = 8 mm	28.67.38P	28.67.38
a = 10 mm	28.67.40P	28.67.40
a = 12 mm	28.67.42P	28.67.42
a = 15 mm	28.67.45P	28.67.45
a = 20 mm	28.67.50P	28.67.50
a = 22 mm	28.67.52P	28.67.52
a = 25 mm	28.67.55P	28.67.55





Scharfe Löffel
Sharp Curettes
Cucharillas cortantes
Curettes tranchantes
Cucchiai taglienti

A10

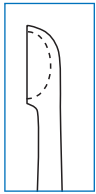

Bruns

# 0000	# 000	# 00	# 0	# 1
27 cm – 10 ³ / ₄ "	27 cm – 10 ³ / ₄ "	27 cm – 10 ³ / ₄ "	27 cm – 10 ³ / ₄ "	27 cm – 10 ³ / ₄ "
29.56.24P	29.56.33P	29.56.42P	29.56.50P	29.56.51P
29.56.24	29.56.33	29.56.42	29.56.50	29.56.51

# 2	# 3	# 4	# 5	# 6
27 cm – 10 ³ / ₄ "	27 cm – 10 ³ / ₄ "	27 cm – 10 ³ / ₄ "	27 cm – 10 ³ / ₄ "	27 cm – 10 ³ / ₄ "
29.56.52P	29.56.53P	29.56.54P	29.56.55P	29.56.56P
29.56.52	29.56.53	29.56.54	29.56.55	29.56.56



Kunststoffgriff (autoklavierbar bis 134 °C bei 3 bar)
 Plastic handle (autoclavable up to 134 °C at 3 bar)
 Mango de plástico (autoclavable hasta 134 °C bajo presión de 3 bar)
 Manche en plastique (autoclavable à 134 °C sous pression de 3 bars)
 Manico di plastica (autoclavabile fino a 134 °C sotto pressione di 3 bar)

Scharfe Löffel
Sharp Curettes
Cucharillas cortantes
Curettes tranchantes
Cucchiai taglienti

A10

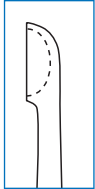

Bruns

# 0000	# 000	# 00	# 0	# 1
33 cm - 13"	33 cm - 13"	33 cm - 13"	33 cm - 13"	33 cm - 13"
29.57.24P	29.57.33P	29.57.42P	29.57.50P	29.57.51P
29.57.24	29.57.33	29.57.42	29.57.50	29.57.51

# 2	# 3	# 4	# 5	# 6
33 cm - 13"	33 cm - 13"	33 cm - 13"	33 cm - 13"	33 cm - 13"
29.57.52P	29.57.53P	29.57.54P	29.57.55P	29.57.56P
29.57.52	29.57.53	29.57.54	29.57.55	29.57.56



Kunststoffgriff (autoklavierbar bis 134 °C bei 3 bar)
 Plastic handle (autoclavable up to 134 °C at 3 bar)
 Mango de plástico (autoclavable hasta 134 °C bajo presión de 3 bar)
 Manche en plastique (autoclavable à 134 °C sous pression de 3 bars)
 Manico di plastica (autoclavabile fino a 134 °C sotto pressione di 3 bar)



Scharfe Löffel
Sharp Curettes
Cucharillas cortantes
Curettes tranchantes
Cucchiai taglienti

A10

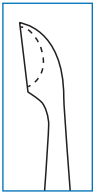

Bruns

# 0000	# 000	# 00	# 0	# 1
23 cm - 9"	23 cm - 9"	23 cm - 9"	23 cm - 9"	23 cm - 9"
29.55.24	29.55.33	29.55.42	29.55.50	29.55.51

# 2	# 3	# 4	# 5	# 6
23 cm - 9"	23 cm - 9"	23 cm - 9"	23 cm - 9"	23 cm - 9"
29.55.52	29.55.53	29.55.54	29.55.55	29.55.56

Scharfe Löffel
Sharp Curettes
Cucharillas cortantes
Curettes tranchantes
Cucchiai taglienti

A10

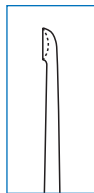

Lempert

000000



21 cm – 8¼"
29.67.06

00000



21 cm – 8¼"
29.67.15

0000



21 cm – 8¼"
29.67.24

000



21 cm – 8¼"
29.67.33

00



21 cm – 8¼"
29.67.42

0



21 cm – 8¼"
29.67.50

1



21 cm – 8¼"
29.67.51

2



21 cm – 8¼"
29.67.52



A10

Scharfe Löffel
Sharp Currettes
Cucharillas cortantes
Currettes tranchantes
Cucchiai taglienti

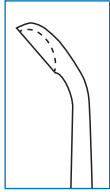

Daubenspeck

00



20 cm - 8"

29.68.42

0



20 cm - 8"

29.68.50

1



20 cm - 8"

29.68.51

2



20 cm - 8"

29.68.52



Halle

1



21 cm - 8 1/4"

29.69.51

2



21 cm - 8 1/4"

29.69.52

3



21 cm - 8 1/4"

29.69.53



biegbar
 malleable
 maleables
 malleables
 malleabili

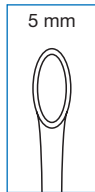

Scoville



25 cm – 10"

57.43.01



25 cm – 10"

57.43.02



25 cm – 10"

57.43.03

the art of surgery

Weitere MEDICON-Produkte finden Sie in unserem Hauptkatalog.

You will find further MEDICON products in our main catalogue.

Más productos de MEDICON se encuentra en nuestro catálogo general.

Vous trouverez d'autres produits MEDICON dans notre catalogue général.

Altri prodotti MEDICON si trovano nel nostro catalogo generale.

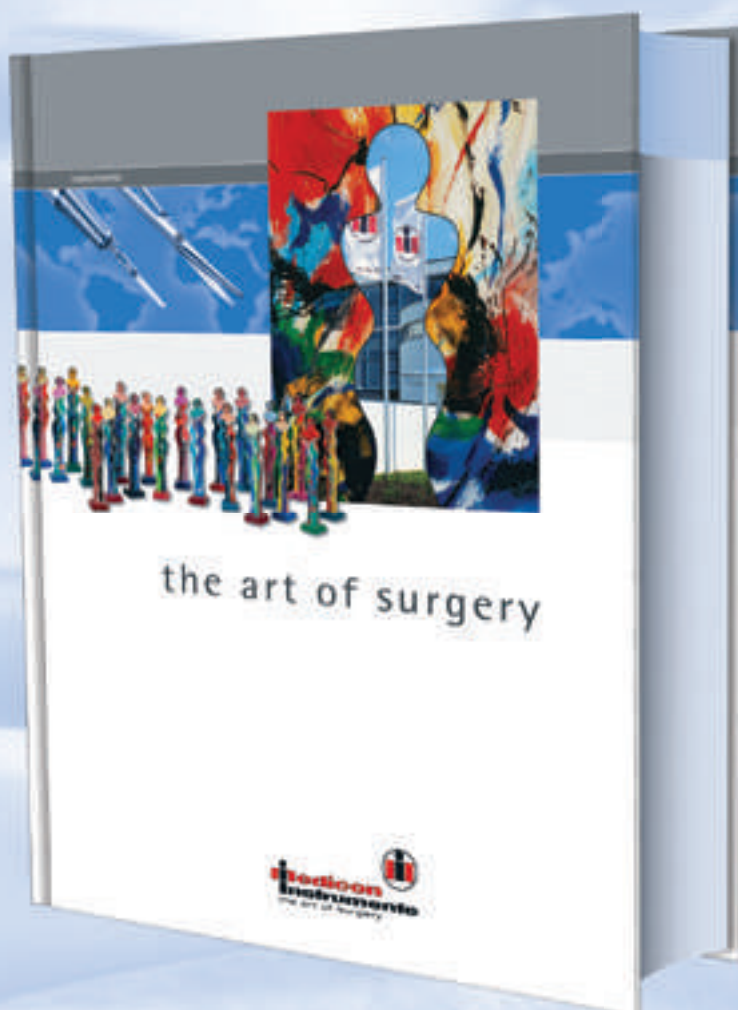

450.00.03

Hohlmeißelzangen
Bone Rongeurs
Pinzas gubias
Pinces-gouges
Pinze sgorbie

A11

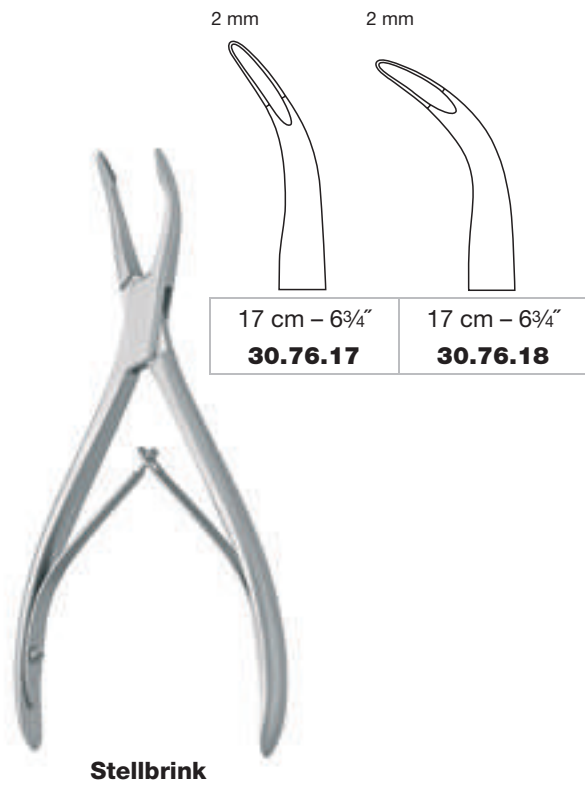
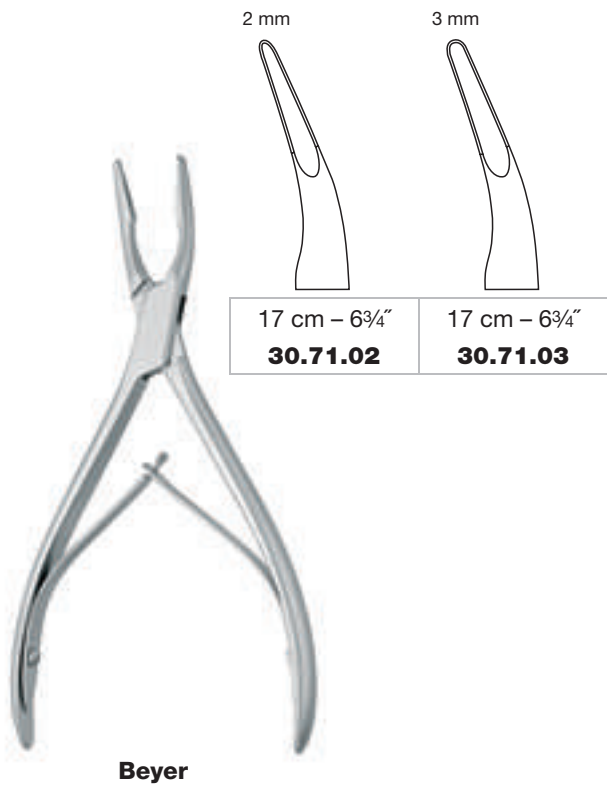
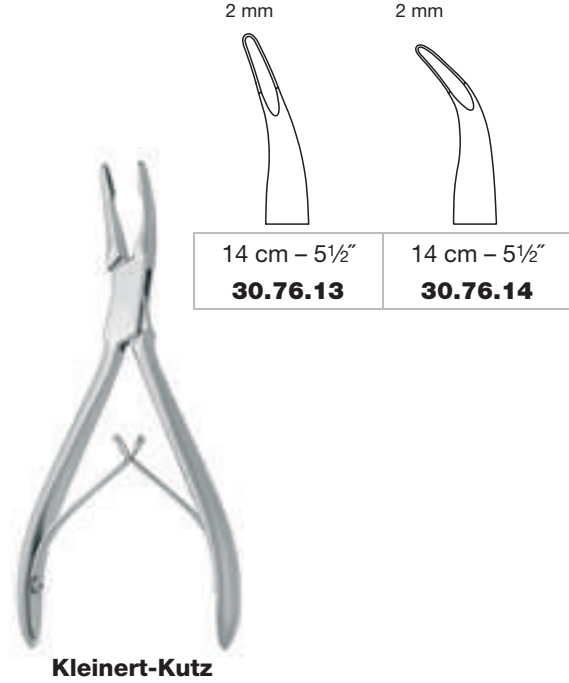
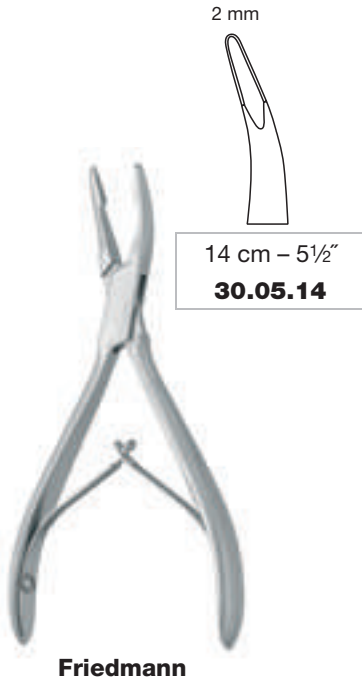



Hohlmeißelzangen
Bone Rongeurs
Pinzas gubias
Pinces-gouges
Pinze sgorbie

A11

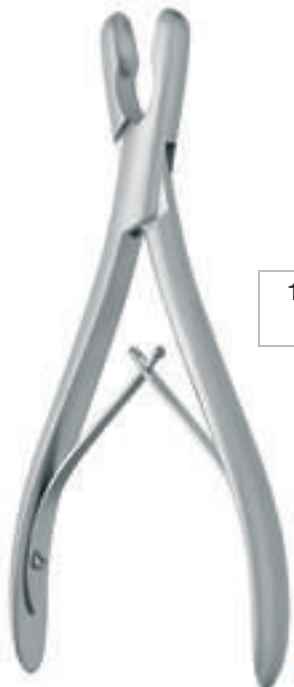

7 mm

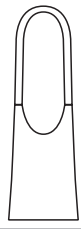

18 cm – 7 1/8"
30.52.17

10 mm

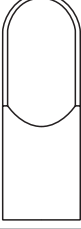

18 cm – 7 1/8"
30.52.18

Luer



9 mm



18 cm – 7 1/8"
30.53.18

Luer



4 mm



20 cm – 8"
30.54.70

Bacon



3 mm



19 cm – 7 1/2"
30.76.19

3 mm



19 cm – 7 1/2"
30.76.29





Lempert

Hohlmeißelzangen
Bone Rongeurs
Pinzas gubias
Pinces-gouges
Pinze sgorbie

A11





Ruskin-Mini

	2 mm	3 mm	2 mm	3 mm
				
	15 cm – 6"	15 cm – 6"	15 cm – 6"	15 cm – 6"
	31.04.02	31.04.03	31.05.02	31.05.03



Ruskin

	5 mm	5 mm
		
	18 cm – 7 1/8"	18 cm – 7 1/8"
	31.06.05	31.07.05



Hohlmeißelzangen
Bone Rongeurs
Pinzas gubias
Pinces-gouges
Pinze sgorbie

A11



Smith-Petersen

2 mm



24 cm - 9½"
31.09.03

3 mm



24 cm - 9½"
31.09.13

3 mm

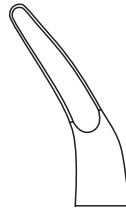

24 cm - 9½"
31.09.23



Ruskin

5 mm



24 cm - 9½"
31.06.25

5 mm



24 cm - 9½"
31.07.25

Hohlmeißelzangen
Bone Rongeurs
Pinzas gubias
Pinces-gouges
Pinze sgorbie

A11

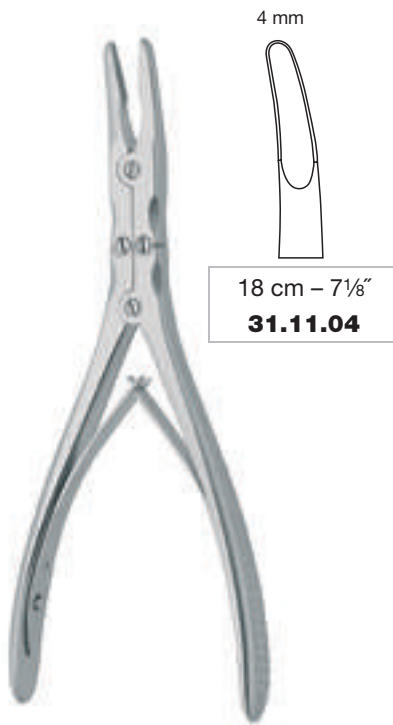

Bayer

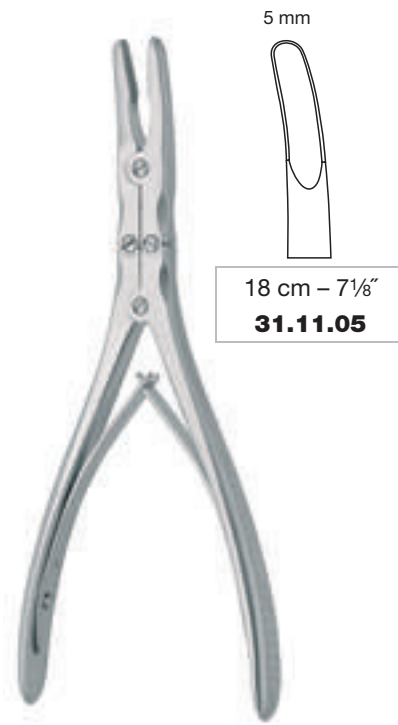

Zaufal-Jansen

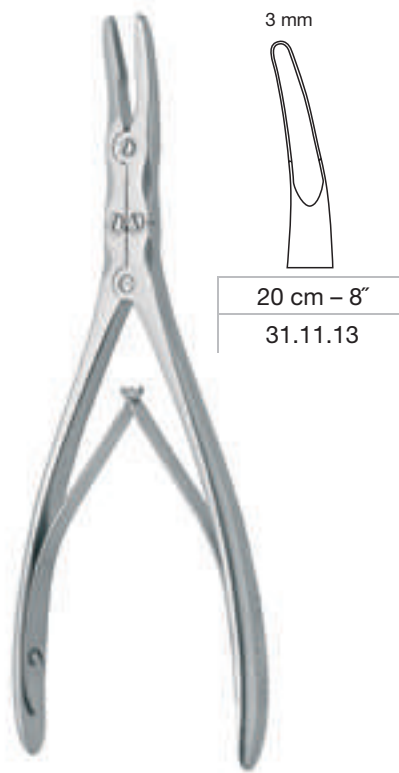

Marquardt



Hohlmeißelzangen
Bone Rongeurs
Pinzas gubias
Pinces-gouges
Pinze sgorbie

A11



Stille-Luer

10 mm



23 cm - 9"
31.30.23

17 mm

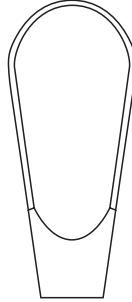

23 cm - 9"
31.30.24

10 mm



23 cm - 9"
31.31.23

17 mm

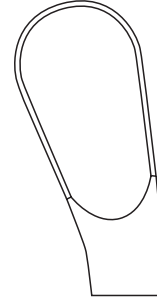

23 cm - 9"
31.31.24

20 mm



23 cm - 9"
31.31.53

20 mm

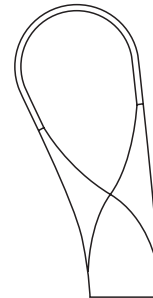

27 cm - 10 3/4"
31.31.57



Semb-Stille

Hohlmeißelzangen
Bone Rongeurs
Pinzas gubias
Pinces-gouges
Pinze sgorbie

A11



Leksell

3 mm



23 cm - 9"
31.53.03

5 mm

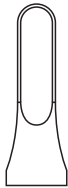

23 cm - 9"
31.53.05

8 mm

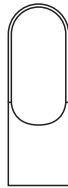

23 cm - 9"
31.53.08



Leksell

5 mm

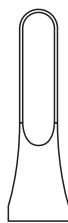

23 cm - 9"
31.51.05

8 mm



23 cm - 9"
31.51.08



Hohlmeißelzangen
Bone Rongeurs
Pinzas gubias
Pinces-gouges
Pinze sgorbie

A11



Stille

7 mm

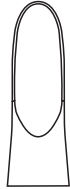

23 cm - 9"
31.31.83



Leksell

3 mm

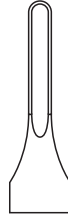

36 cm - 14 1/8"
31.54.03

5 mm

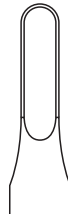

36 cm - 14 1/8"
31.54.05

8 mm



36 cm - 14 1/8"
31.54.08

Hohlmeißelzangen und Knochensplitterzange
Bone Rongeurs and Bone Cutting Forceps
Pinzas gubias y pinza cortante para huesos
Pinces-gouges et pince coupante à os
Pinze sgorbie e pinza ossivora

A11



Echlin

Knochensplitterzange
 Bone cutting forceps
 Pinza cortante para huesos
 Pince coupante à os
 Pinza ossivora

3 mm



23 cm – 9"
31.61.02

5 mm

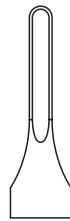

23 cm – 9"
31.61.03

8 mm

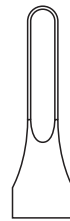

23 cm – 9"
31.61.04



Liston-Key

26 cm – 10¼"
33.75.27



Knochensplitterzangen
Bone Cutting Forceps
Pinzas cortantes para huesos
Pinces coupantes à os
Pinze ossivore

A11



15 cm – 6"
33.02.15

Littauer-Liston

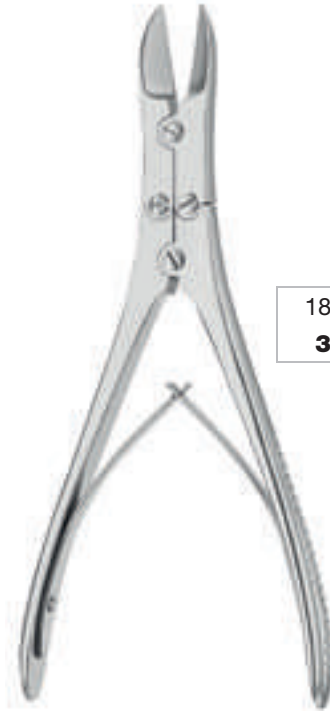

18 cm – 7 1/8"
33.56.18



18 cm – 7 1/8"
33.57.18

Ruskin-Liston



17 cm – 6 3/4"
33.59.17

McIndoe



18 cm – 7 1/8"
33.58.18



18 cm – 7 1/8"
33.59.18

McIndoe



**Instrumente für die spinale Neurochirurgie
Instruments for Spinal Neurosurgery
Instrumentos para neurocirugía espinal
Instruments pour la neurochirurgie spinale
Strumenti per la neurochirurgia spinale**

B

**neuro
SPINALIS**

Instrumente für die spinale Neurochirurgie
Instruments for Spinal Neurosurgery
Instrumentos para neurocirugía espinal
Instruments pour la neurochirurgie spinale
Strumenti per la neurochirurgia spinale

B01	Minimal-invasive Zugangstechniken Minimally invasive approaches Técnicas de acceso mínimamente invasivas Techniques d'accès mini-invasives Tecniche d'accesso mini-invasive	141
CERVICALINO PICCOLINO	Minimal-invasive Spreizersysteme für die Wirbelsäule Minimally invasive spinal spreading systems Sistemas de separadores mínimamente invasivos para la columna vertebral Systèmes d'écarteurs mini-invasives pour la colonne vertébrale Sistemi di divaricazione mini-invasivi per la colonna vertebrale	143
MICRODISC-XS	Miniaturisierte (XS) Mikrodiskektomie Miniaturized (XS) micro-discectomy Microdiscectomía miniaturizada (XS) Microdiscectomie miniaturisée (XS) Microdiscectomia miniaturizzata (XS)	157
M.A.P.N	Mikroskopisch assistierte perkutane Nucleotomie Microscopically assisted percutaneous nucleotomy Nucleotomía percutánea microscópicamente asistida Nucléotomie percutanée assistée au microscope Nucleotomia percutanea assistita al microscopio	167
THORAMIC	Thorakoskopische Minimal-Invasive Chirurgie Thoracoscopic minimally invasive surgery Cirugía toracoscópica mínimamente invasiva Chirurgie thoracoscopique mini-invasive Chirurgia toracoscopica mini-invasiva	177
B02	Spreizersysteme für die Wirbelsäule Spinal spreading systems Sistemas de separadores para la columna vertebral Systèmes d'écarteurs pour la colonne vertébrale Sistemi di divaricazione per la colonna vertebrale	191
B03	Zervikales Wirbelkörper-Distraktionssystem Cervical vertebral body distraction system Sistema de distractor para el cuerpo vertebral cervical Système distracteur pour les vertébrales cervicales Sistema distrattore per il corpo vertebrale cervicale	233
B04	Stanzen und Rongeure Rongeurs Pinzas saca-bocadas y pinzas cortantes Pincas emporte-pièce et rongeurs Laminotomi e pinze per laminectomia	237
B05	Haken und Dissektoren Hooks and dissectors Separadores y disectores Crochets et dissecteurs Uncini e dissectori	271
B06	Diamantmesser und Mikro-Instrumente Diamond knives and micro instruments Cuchillos de diamante y micro instrumentos Couteau de diamant et micro instruments Bisturi diamantati e micro strumenti	291
B07	Spongiosaentnahme aus dem Beckenkamm Cancellous bone extraction from the pelvic crest Extracción esponjosa de la cresta iliaca Extraction spongieuse de l'os iliaque Estrazione spongiosa dalla cresta iliaca	303
B08	Druckluftmotorensystem Pneumatic high speed system Sistema de motor neumático Système de moteur pneumatique Sistema motore pneumatico	307

Minimal-invasive Zugangstechniken
Minimally Invasive Approaches
Técnicas de acceso mínimamente invasivas
Techniques d'accès mini-invasives
Tecniche d'accesso mini-invasive

B01



Motiv: Bildwerk Rohr

MINIMIZED TO MAXIMIZE

451.04.32



Weitere Informationen finden Sie in unserem Sonderprospekt.
 For further information please see our special brochure.
 Informaciones adicionales se encuentran en nuestro folleto especial.
 Vous trouverez de plus amples informations dans notre prospectus spécial.
 Troverete più informazioni nel nostro depliant speciale.

**B01**

Minimal-invasive Zugangstechniken
Minimally Invasive Approaches
Técnicas de acceso mínimamente invasivas
Techniques d'accès mini-invasives
Tecniche d'accesso mini-invasive

CERVICALINO

Minimal-invasive Spreizersysteme für die Wirbelsäule
Minimally invasive spinal spreading systems
Sistemas de separadores mínimamente invasivos para la columna vertebral
Systèmes d'écarteurs mini-invasives pour la colonne vertébrale
Sistemi di divaricazione mini-invasivi per la colonna vertebrale

PICCOLINO

Minimal-invasive Spreizersysteme für die Wirbelsäule
Minimally invasive spinal spreading systems
Sistemas de separadores mínimamente invasivos para la columna vertebral
Systèmes d'écarteurs mini-invasives pour la colonne vertébrale
Sistemi di divaricazione mini-invasivi per la colonna vertebrale

MICRODISC-XS

Miniaturisierte (XS) Mikrodisektomie
Miniaturized (XS) micro-discectomy
Microdiscectomía miniaturizada (XS)
Microdiscectomie miniature (XS)
Microdiscectomia miniaturizzata (XS)

M·A·P·N

Mikroskopisch assistierte perkutane Nukleotomie
Microscopically assisted percutaneous nucleotomy
Nucleotomía percutánea microscópicamente asistida
Nucléotomie percutanée assistée au microscope
Nucleotomia percutanea assistita al microscopio

THORAMIC

Thorakoskopische Minimal-Invasive Chirurgie
Thoracoscopic minimally invasive surgery
Cirugía toracoscópica mínimamente invasiva
Chirurgie thoracoscopique mini-invasive
Chirurgia toracoscopica mini-invasiva

Minimal-invasive Zugangstechniken
Minimally Invasive Approaches
Técnicas de acceso mínimamente invasivas
Techniques d'accès mini-invasives
Tecniche d'accesso mini-invasive

B01

Das "CERVICALINO" Wirbelsäulen-Spreizersystem ist geeignet für anteriore zervikale Zugangstechniken.

The "CERVICALINO" spinal spreading system is suitable for anterior cervical approach techniques.

El sistema separador de la columna vertebral "CERVICALINO" es adecuado para técnicas de acceso cervical anterior.

Le système d'écarteurs pour la colonne vertébrale "CERVICALINO" convient pour les techniques d'accès cervicales antérieures.

Il sistema di divaricazione per la colonna vertebrale "CERVICALINO" è adatto per tecniche d'accesso anterior alla cervicale.

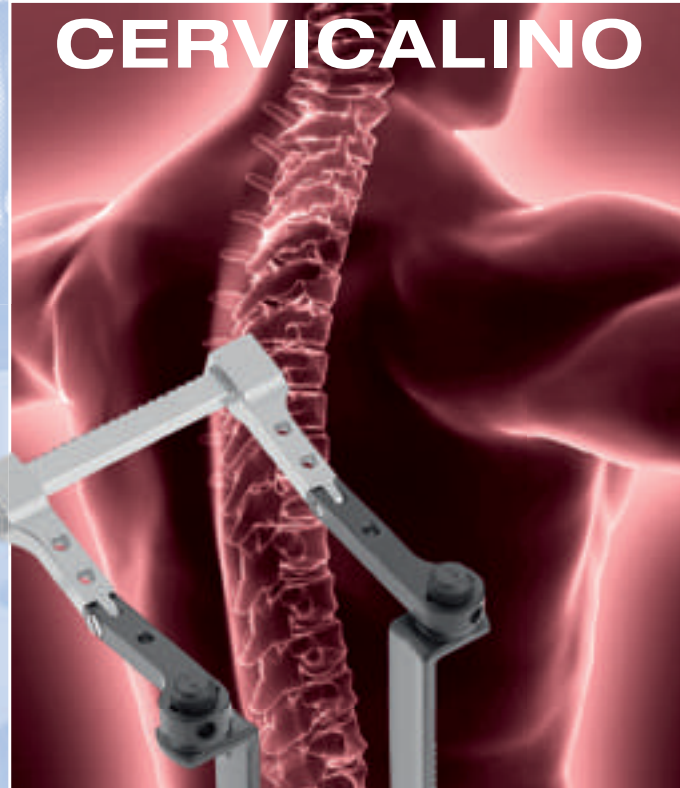

Minimal-invasive Spreizersysteme für die Wirbelsäule
Minimally invasive spinal spreading systems
Sistemas de separadores mínimamente invasivos para la columna vertebral
Systèmes d'écarteurs mini-invasives pour la colonne vertébrale
Sistemi di divaricazione mini-invasivi per la colonna vertebrale

entwickelt in Zusammenarbeit mit:
 developed in cooperation with:
 desarrollado en colaboración con:
 développée en collaboration avec:
 sviluppato in collaborazione con:

Prof. Dr. med. Luca Papavero
 Neurochirurg · Klinik für Spinale Chirurgie · Klinikum Eilbek
 Dehnhaide 120 · 22081 Hamburg



Minimal-invasive Spreizersysteme für die Wirbelsäule
Minimally Invasive Spinal Spreading Systems
Sistemas de separadores mínimamente invasivos para la columna vertebral
Systèmes d'écarteurs mini-invasives pour la colonne vertébrale
Sistemi di divaricazione mini-invasivi per la colonna vertebrale

B01

- ▶ Eleganter miniaturisierter Spreizer für minimal-invasive Zugänge an der Halswirbelsäule
- ▶ Miniaturisierte Ausführung verbessert Bewegungsfreiheit im OP-Bereich
- ▶ Elegant miniaturized retractor for minimally invasive approaches on the cervical spine
- ▶ Miniaturized model improves freedom of movement in the surgical area
- ▶ Elegante sistema de separador para accesos de mínimamente invasivos en la columna vertebral cervical
- ▶ El diseño miniaturizado mejora la libertad de movimiento en la zona de la operación
- ▶ Ecarteur élégant miniaturisé pour garantir un accès mini-invasives possible à la colonne vertébrale cervical
- ▶ Modèle miniaturisé améliorant la liberté de mouvement en salle d'opération
- ▶ Elegante divaricatore miniaturizzato per accessi mini-invasivi alla colonna vertebrale cervicale
- ▶ La versione miniaturizzata aumenta la libertà di movimento in sala operatoria

Minimal-invasive Spreizersysteme für die Wirbelsäule
Minimally Invasive Spinal Spreading Systems
Sistemas de separadores mínimamente invasivos para la columna vertebral
Systèmes d'écarteurs mini-invasives pour la colonne vertébrale
Sistemi di divaricazione mini-invasivi per la colonna vertebrale

B01

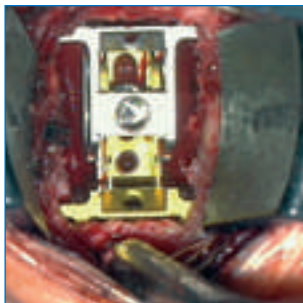

Der anteriore zervikale Zugang ist in der Wirbelsäulenchirurgie ein etabliertes Verfahren. Mehr noch als bei anderen Techniken ist akribische Sorgfalt ein Schlüsselfaktor für den Behandlungserfolg.

Dies zeigt sich an dem breiten potentiellen Komplikationsspektrum dieses Zuganges. Im Gegensatz dazu ist die Komplikations-Inzidenz bei Eingriffen an lumbalen Rezidiv-Bandscheibenvorfällen relativ homogen. [1]

The anterior cervical approach is a well accepted procedure in the midst of the spine surgery community. Perhaps more than in other procedures, in anterior cervical surgery, a painstaking attention to the detail is one of the key factors to the therapeutic success.

This is demonstrated by the broad range of incidence of complications in the different series, in contrast to the quite homogenous incidence of recurrent herniation in lumbar disc surgery. [1]

El acceso cervical anterior es un procedimiento consolidado en la cirugía de la columna vertebral. Más que en otras técnicas, el sumo cuidado es un factor clave para que el tratamiento tenga éxito.

Esto se refleja en las considerables complicaciones potenciales que presenta este acceso. En contraste, la incidencia de complicaciones en intervenciones en casos de recidiva de hernia discal es relativamente homogénea. [1]

L'accès cervical antérieur est une méthode établie dans la chirurgie spinale. Encore plus que pour les autres techniques, un soin méticuleux est un facteur clé pour le succès du traitement.

Cela se remarque au large spectre de complications potentielles de cet accès. Par contre, l'incidence des complications pour les interventions sur les hernies discales lombaires récidivantes est relativement homogène. [1]

L'accesso cervicale anteriore è, nella chirurgia della colonna vertebrale, una procedura definita. Ancor più che nelle altre tecniche, la precisione minuziosa rappresenta un fattore chiave per il successo del trattamento. Questo deriva dall'ampio spettro di potenziali complicanze di questo accesso. Al contrario, l'incidenza di complicanze in interventi sull'ernia discale lombare recidiva è relativamente omogenea. [1]

[1] Cheung KM, Mak K, Luk KD (2011) Anterior Approach to Cervical Spine. Spine (Oct 24)

**B01**

Minimal-invasive Spreizersysteme für die Wirbelsäule
Minimally Invasive Spinal Spreading Systems
Sistemas de separadores mínimamente invasivos para la columna vertebral
Systèmes d'écarteurs mini-invasives pour la colonne vertébrale
Sistemi di divaricazione mini-invasivi per la colonna vertebrale

Spreizersystem mit Gelenk
 Spreading system with joint
 Sistema separador con articulación
 Système d'écarteur avec articulation
 Sistema di divaricazione con articolazione

57.58.59

Spreizer (allein)
 Retractor (only)
 Separador (solo)
 Ecarteur (seul)
 Divaricatore (solo)

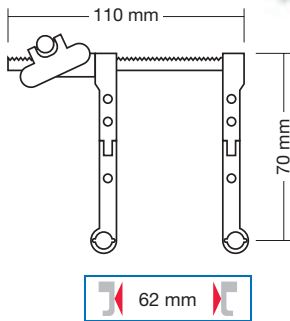
**"CERVICALINO" Set I****57.58.60**

Satz bestehend aus: Set consisting of: Juego compuesto por: Jeu composé de: Set composto da:	57.58.59 Retractor with joint	1x
	57.59.63 PEEK blade with 4 teeth (40 x 12 mm)	2x
	57.59.64 PEEK blade with 4 teeth (45 x 12 mm)	2x
	57.59.65 PEEK blade with 4 teeth (50 x 12 mm)	2x
	57.59.66 PEEK blade with 4 teeth (55 x 12 mm)	2x
	57.59.67 PEEK blade with 4 teeth (60 x 12 mm)	2x
	57.59.68 PEEK blade with 4 teeth (65 x 12 mm)	2x
	57.59.69 PEEK blade with 4 teeth (75 x 12 mm)	2x



150



Valven (siehe Seite 150)
 Blades (see page 150)
 Valvas (véase página 150)
 Valves (voir page 150)
 Valve (vedi pagina 150)



Maximale Spreizweite zwischen den Valven
 Maximum spreading width between the blades
 Abertura máxima entre las valvas
 Apertura maximale entre les valves
 Apertura massima tra le valve



siehe Seite
 see page
 véase página
 voir page
 vedi pagina

Minimal-invasive Spreizersysteme für die Wirbelsäule
Minimally Invasive Spinal Spreading Systems
Sistemas de separadores mínimamente invasivos para la columna vertebral
Systèmes d'écarteurs mini-invasives pour la colonne vertébrale
Sistemi di divaricazione mini-invasivi per la colonna vertebrale

B01

Spreizer mit Gelenk und Kupplung
 Retractors with joint and connector
 Separadores con articulación y acoplamiento
 Ecarteurs avec articulation et accouplement
 Divaricatori con articolazione e accoppiamento



57.58.55

Kupplung für Haltearme
 Connector for holding arms
 Acoplamiento para brazos de soportes
 Accouplement pour bras de support
 Accoppiamento per bracci di supporto



57.58.56



175-176



Haltearme (siehe Seite 175-176)
 Holding arms (see page 175-176)
 Brazos de soportes (véase página 175-176)
 Bras de support (voir page 175-176)
 Bracci di supporto (vedi pagina 175-176)

CERVICALINO



siehe Seite
 see page
 véase página
 voir page
 vedi pagina



Minimal-invasive Spreizersysteme für die Wirbelsäule
Minimally Invasive Spinal Spreading Systems
Sistemas de separadores mínimamente invasivos para la columna vertebral
Systèmes d'écarteurs mini-invasives pour la colonne vertébrale
Sistemi di divaricazione mini-invasivi per la colonna vertebrale

B01



- ▶ Röntgentransparente Valven und Valven-Aufnahmen aus PEEK
- ▶ Implantat und Instrumente werden bei der bidirektionalen Fluoroskopie optimal dargestellt
- ▶ X-ray transparent PEEK-blades and blade supports
- ▶ Implant and instruments are optimally displayed during bidirectional fluoroscopy
- ▶ Valvas y soporte de valvas de PEEK transparentes a los rayos X
- ▶ Los implantes e instrumentos se muestran mejor en la fluoroscopia bidireccional
- ▶ Valves et support de valves en PEEK, transparents aux rayons X
- ▶ Les implants et instruments sont parfaitement représentés en cas de fluoroscopie bidirectionnelle
- ▶ Valve e supporto valve in PEEK trasparenti ai raggi X
- ▶ L'impianto e gli strumenti sono raffigurati in modo ottimale durante la fluoroscopia bidirezionale

Spreizersystem mit Gelenk
 Spreading system with joint
 Sistema de separador con articulación
 Système d'écarteur avec articulation
 Sistema di divaricazione con articolazione

57.58.62

Spreizer (allein)
 Retractor (only)
 Separador (solo)
 Ecarteur (seul)
 Divaricatore (solo)

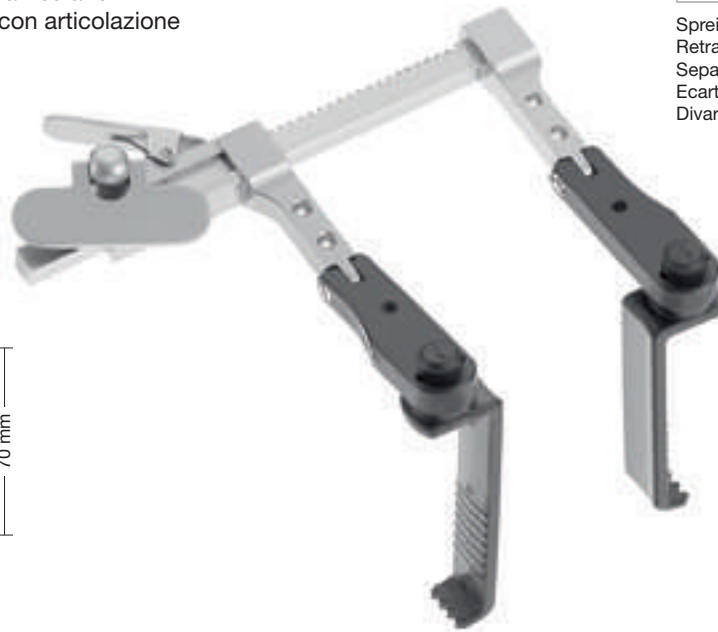
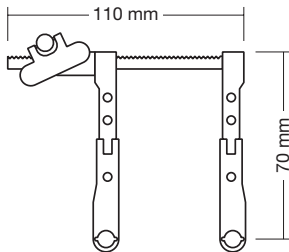
**"CERVICALINO" Set II****57.58.63**

Satz bestehend aus: Set consisting of: Juego compuesto por: Jeu composé de: Set composto da:	57.58.62 Retractor with joint and X-ray transparent blade supports	1x
	57.59.63 PEEK blade with 4 teeth (40 x 12 mm)	2x
	57.59.64 PEEK blade with 4 teeth (45 x 12 mm)	2x
	57.59.65 PEEK blade with 4 teeth (50 x 12 mm)	2x
	57.59.66 PEEK blade with 4 teeth (55 x 12 mm)	2x
	57.59.67 PEEK blade with 4 teeth (60 x 12 mm)	2x
	57.59.68 PEEK blade with 4 teeth (65 x 12 mm)	2x
57.59.69 PEEK blade with 4 teeth (75 x 12 mm)	2x	



Maximale Spreizweite zwischen den Valven
 Maximum spreading width between the blades
 Abertura máxima entre las valvas
 Aperture maximale entre les valves
 Apertura massima tra le valve

Minimal-invasive Spreizersysteme für die Wirbelsäule
Minimally Invasive Spinal Spreading Systems
Sistemas de separadores mínimamente invasivos para la columna vertebral
Systèmes d'écarteurs mini-invasives pour la colonne vertébrale
Sistemi di divaricazione mini-invasivi per la colonna vertebrale

B01

Spreizer mit Gelenk und Kupplung
 Retractors with joint and connector
 Separadores con articulación y acoplamiento
 Ecarteurs avec articulation et accouplement
 Divaricatori con articolazione e accoppiamento



57.58.57

Kupplung für Haltearme
 Connector for holding arms
 Acoplamiento para brazos de soportes
 Accouplement pour bras de support
 Accoppiamento per bracci di supporto



57.58.58



Haltearme (siehe Seite 175-176)
 Holding arms (see page 175-176)
 Brazos de soportes (véase página 175-176)
 Bras de support (voir page 175-176)
 Bracci di supporto (vedi pagina 175-176)



Valven (siehe Seite 150)
 Blades (see page 150)
 Valvas (véase página 150)
 Valves (voir page 150)
 Valve (vedi pagina 150)

CERVICALINO



siehe Seite
 see page
 véase página
 voir page
 vedi pagina

**B01**

Minimal-invasive Spreizersysteme für die Wirbelsäule
Minimally Invasive Spinal Spreading Systems
Sistemas de separadores mínimamente invasivos para la columna vertebral
Systèmes d'écarteurs mini-invasives pour la colonne vertébrale
Sistemi di divaricazione mini-invasivi per la colonna vertebrale

Valven aus PEEK mit Fixierungs-Pin
 PEEK blades with fixation pin
 Valvas de PEEK con perno de fijación
 Valves en PEEK avec pivot de fixation
 Valve in PEEK con perno di fissazione



Vollständige Röntgentransparenz
 Excellent X-ray transparency
 Completamente trasparente a los rayos X
 Complètement transparent pour les rayons X
 Completamente trasparente ai raggi X

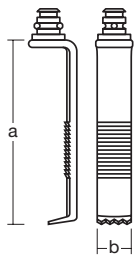

cervical / lumbar



a	b		
40 mm	12 mm	4	57.59.63
45 mm	12 mm	4	57.59.64
50 mm	12 mm	4	57.59.65
55 mm	12 mm	4	57.59.66
60 mm	12 mm	4	57.59.67
65 mm	12 mm	4	57.59.68
75 mm	12 mm	4	57.59.69

Vollständige Röntgentransparenz
 Excellent X-ray transparency
 Completamente trasparente a los rayos X
 Complètement transparent pour les rayons X
 Completamente trasparente ai raggi X

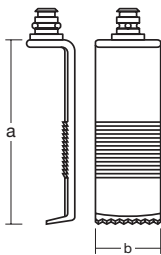

cervical / lumbar



a	b		
40 mm	23 mm	8	57.59.79
45 mm	23 mm	8	57.59.80
50 mm	23 mm	8	57.59.81
55 mm	23 mm	8	57.59.82
60 mm	23 mm	8	57.59.83
65 mm	23 mm	8	57.59.84
75 mm	23 mm	8	57.59.85



Das "PICCOLINO" Wirbelsäulen-Spreizersystem eignet sich sowohl für miniaturisierte subperiostale paravertebrale, als auch für transmuskuläre Zugangstechniken.

The "PICCOLINO" spinal spreading system is suitable for miniaturized subperiosteal paravertebral access techniques as well as for transmuscular approaches.

El sistema de separador para la columna vertebral "PICCOLINO" es adecuado tanto para técnicas de acceso miniaturizado, subperióstico y paravertebral, así como para el transmuscular.

Le système d'écarteur pour la colonne vertébrale "PICCOLINO" convient pour les techniques d'accès paravertébrales miniaturisées, tant par voie sous-périostée que par voie transmusculaire.

Il sistemi di divaricazione per la colonna vertebrale "PICCOLINO" è perfettamente adatto per tecniche miniaturizzate di accesso paravertebrale subperiostale e anche transmuscolare.



Minimal-invasive Spreizersysteme für die Wirbelsäule
Minimally invasive spinal spreading systems
Sistemas de separadores mínimamente invasivos para la columna vertebral
Systèmes d'écarteurs mini-invasives pour la colonne vertébrale
Sistemi di divaricazione mini-invasivi per la colonna vertebrale

entwickelt in Zusammenarbeit mit:
 developed in cooperation with:
 desarrollado en colaboración con:
 développée en collaboration avec:
 sviluppato in collaborazione con:

Prof. Dr. med. Luca Papavero
 Neurochirurg · Klinik für Spinale Chirurgie · Klinikum Eilbek
 Dehnhaide 120 · 22081 Hamburg



Minimal-invasive Spreizersysteme für die Wirbelsäule
Minimally Invasive Spinal Spreading Systems
Sistemas de separadores mínimamente invasivos para la columna vertebral
Systèmes d'écarteurs mini-invasives pour la colonne vertébrale
Sistemi di divaricazione mini-invasivi per la colonna vertebrale

B01



- ▶ Geringes Kragenprofil vermeidet Druckläsionen der Haut
- ▶ Reduzierte Wandstärke des Spekulum ermöglicht mehr Zugangsvolumen
- ▶ Low collar profile avoids pressure lesions on the skin
- ▶ Reduced wall thickness of the speculum allows more access volume
- ▶ Collar de bajo perfil para evitar lesiones lesiones cutáneas debidas a la presión
- ▶ La reducción del grosor del espéculo permite mayor volumen de acceso
- ▶ Un col au profil réduit évite les lésions cutanées dues à la pression
- ▶ L'épaisseur réduite des parois du spéculum permet un volume d'accès plus important
- ▶ Il profilo ridotto del collare evita lesioni della pelle dovute a pressione
- ▶ Lo spessore ridotto della parete dello specolo consente un maggiore volume d'accesso



Minimal-invasive Spreizersysteme für die Wirbelsäule
Minimally Invasive Spinal Spreading Systems
Sistemas de separadores mínimamente invasivos para la columna vertebral
Systèmes d'écarteurs mini-invasives pour la colonne vertébrale
Sistemi di divaricazione mini-invasivi per la colonna vertebrale

B01

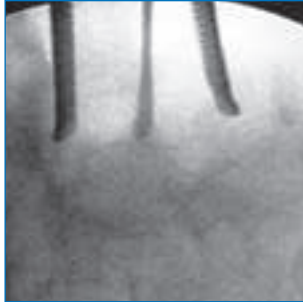

- ▶ Laterale und mediale Valven aus PEEK ermöglichen eine artefaktfreie Darstellung bei seitlicher Röntgendurchleuchtung
- ▶ Lateral and medial PEEK blades allow artefact-free vision during lateral X-ray screening
- ▶ Las valvas laterales y mediales fabricadas en PEEK consiguen una imagen libre de distorsiones en radiografías laterales
- ▶ Des valves latérales et médiales en PEEK permettent une représentation sans artefact en cas de radioscopie latérale
- ▶ Le valve laterali e mediali in PEEK consentono una visualizzazione senza artefatti durante una radioscopia laterale



- ▶ Die zunehmende Spreizung in der Tiefe gewährleistet trotz des miniaturisierten Zugangs eine ausreichende Darstellung des operativen Zielgebietes.
- ▶ The progressive spreading in depth ensures adequate vision of the surgical target area despite the miniaturised approach.
- ▶ La dilatación progresiva en la parte inferior garantiza, a pesar del acceso miniaturizado, una imagen suficiente de la zona objetivo operacional.
- ▶ L'écartement croissant en profondeur garantit une représentation suffisante de la zone opératoire malgré un accès miniaturisé.
- ▶ Il divaricamento crescente in profondità assicura una visualizzazione adeguata della zona da operare malgrado l'accesso miniaturizzato.

**B01**

Minimal-invasive Spreizersysteme für die Wirbelsäule
Minimally Invasive Spinal Spreading Systems
Sistemas de separadores mínimamente invasivos para la columna vertebral
Systèmes d'écarteurs mini-invasives pour la colonne vertébrale
Sistemi di divaricazione mini-invasivi per la colonna vertebrale

Gegensperrer mit Gelenk
 Counter retractor with joint
 Contra-separador con articulación
 Contre-écarteur avec articulation
 Contro-divaricatore con articolazione

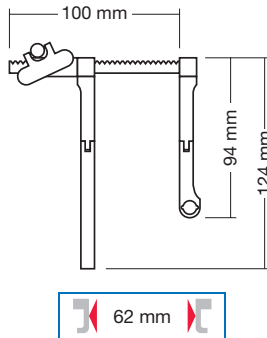
**57.57.52**

Gegensperrer mit Gelenk und Kupplung für Haltearme
 Counter retractor with joint and connector for holding arms
 Contra-separador con articulación y acoplamiento para brazos de soportes
 Contre-écarteur avec au joint et accouplement pour bras de support
 Contro-divaricatore con articolazione e accoppiamento per bracci di supporto

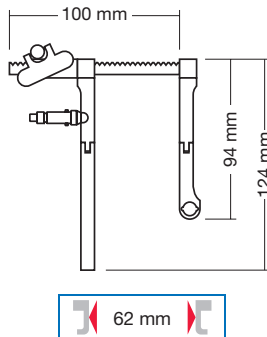
**57.57.62**

175-176



Haltearme (siehe Seite 175-176)
 Holding arms (see page 175-176)
 Brazos de soportes (véase página 175-176)
 Bras de support (voir page 175-176)
 Bracci di supporto (vedi pagina 175-176)



Maximale Spreizweite zwischen den Valven
 Maximum spreading width between the blades
 Abertura máxima entre las valvas
 Aperture maximale entre les valves
 Apertura massima tra le valve



siehe Seite
 see page
 véase página
 voir page
 vedi pagina



Minimal-invasive Spreizersysteme für die Wirbelsäule
Minimally Invasive Spinal Spreading Systems
Sistemas de separadores mínimamente invasivos para la columna vertebral
Systèmes d'écarteurs mini-invasives pour la colonne vertébrale
Sistemi di divaricazione mini-invasivi per la colonna vertebrale

B01

Spekula für Gegensperrer
 Specula for counter retractor
 Espéculos para contra-separador
 Spéculums pour contre-écarteur
 Specoli per contro-divaricatore

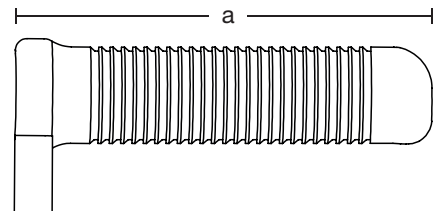
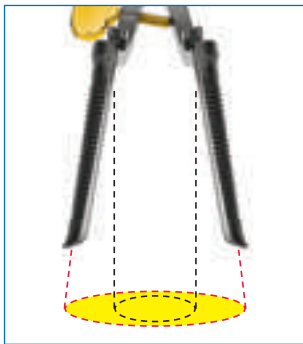

a	
40 mm	57.58.35
45 mm	57.58.36
50 mm	57.58.37
55 mm	57.58.38
60 mm	57.58.39
65 mm	57.58.40
75 mm	57.58.42
85 mm	57.58.44

Valven aus PEEK
 PEEK blades
 Valvas de PEEK
 Valves en PEEK
 Valve in PEEK

Röntgentransparent (für seitliche Durchleuchtung)
 Transparent to X-ray (for lateral fluoroscopy)
 Transparente a los rayos X (para fluoroscopia lateral)
 Transparent pour les rayons X (pour la fluoroscopie latérale)
 Trasparente ai raggi X (per fluoroscopia laterale)

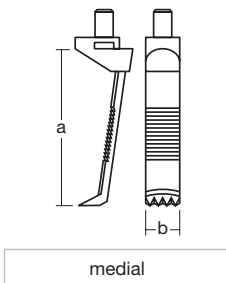

a	b	
40 mm	12 mm	57.60.63
45 mm	12 mm	57.60.64
50 mm	12 mm	57.60.65
55 mm	12 mm	57.60.66
60 mm	12 mm	57.60.67
65 mm	12 mm	57.60.68
75 mm	12 mm	57.60.69

PICCOLINO

**B01**

Minimal-invasive Spreizersysteme für die Wirbelsäule
Minimally Invasive Spinal Spreading Systems
Sistemas de separadores mínimamente invasivos para la columna vertebral
Systèmes d'écarteurs mini-invasives pour la colonne vertébrale
Sistemi di divaricazione mini-invasivi per la colonna vertebrale

Valven aus PEEK mit Fixierungs-Pin
 PEEK blades with fixation pin
 Valvas de PEEK con perno de fijación
 Valves en PEEK avec pivot de fixation
 Valve in PEEK con perno di fissazione



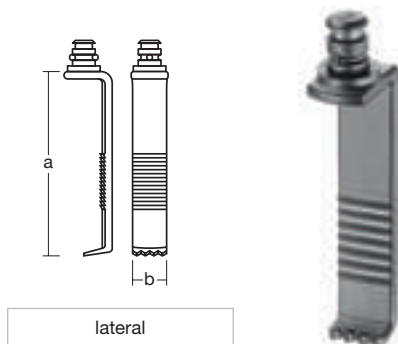

Vollständige Röntgentransparenz
 Excellent X-ray transparency
 Completamente trasparente a los rayos X
 Complètement transparent pour les rayons X
 Completamente trasparente ai raggi X

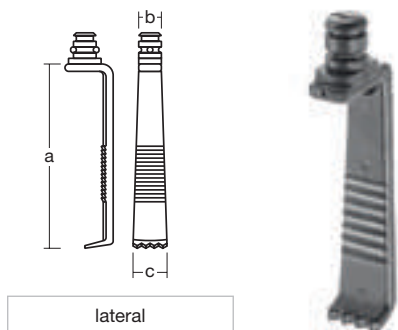

a	b		
40 mm	12 mm	4	57.59.63
45 mm	12 mm	4	57.59.64
50 mm	12 mm	4	57.59.65
55 mm	12 mm	4	57.59.66
60 mm	12 mm	4	57.59.67
65 mm	12 mm	4	57.59.68
75 mm	12 mm	4	57.59.69

Vollständige Röntgentransparenz
 Excellent X-ray transparency
 Completamente trasparente a los rayos X
 Complètement transparent pour les rayons X
 Completamente trasparente ai raggi X



a	b	c		
40 mm	8 mm	12 mm	4	57.60.83
45 mm	8 mm	12 mm	4	57.60.84
50 mm	8 mm	12 mm	4	57.60.85
55 mm	8 mm	12 mm	4	57.60.86
60 mm	8 mm	12 mm	4	57.60.87
65 mm	8 mm	12 mm	4	57.60.88
75 mm	8 mm	12 mm	4	57.60.89



Minimal-invasive Zugangstechniken
Minimally Invasive Approaches
Técnicas de acceso mínimamente invasivas
Techniques d'accès mini-invasives
Tecniche d'accesso mini-invasive

B01

Die MICRODISC-XS-Technik kombiniert den schonenden "endoskopischen" transmuskulären Zugang mit den bewährten "mikrochirurgischen" Vorteilen im Operationssitus.

The MICRODISC-XS technique combines the less traumatic "endoscopic" muscle-splitting approach with the proven "microsurgical" advantages in the surgical field.

La técnica MICRODISC-XS combina el abordaje "endoscópico" transmuscular poco traumático con las comprobadas ventajas "microquirúrgicas" en el sitio quirúrgico.

La technique MICRODISC-XS associe les avantages de la voie d'abord trans-musculaire "endoscopique", moins traumatique, à ceux de la technique "microchirurgicale" qui a fait ses preuves au niveau du site opératoire.

La tecnica MICRODISC-XS combina l'accesso "endoscopico" transmuscolare, poco traumatico, con i vantaggi collaudati della "microchirurgia" nel campo operatorio.

MICRODISC-XS

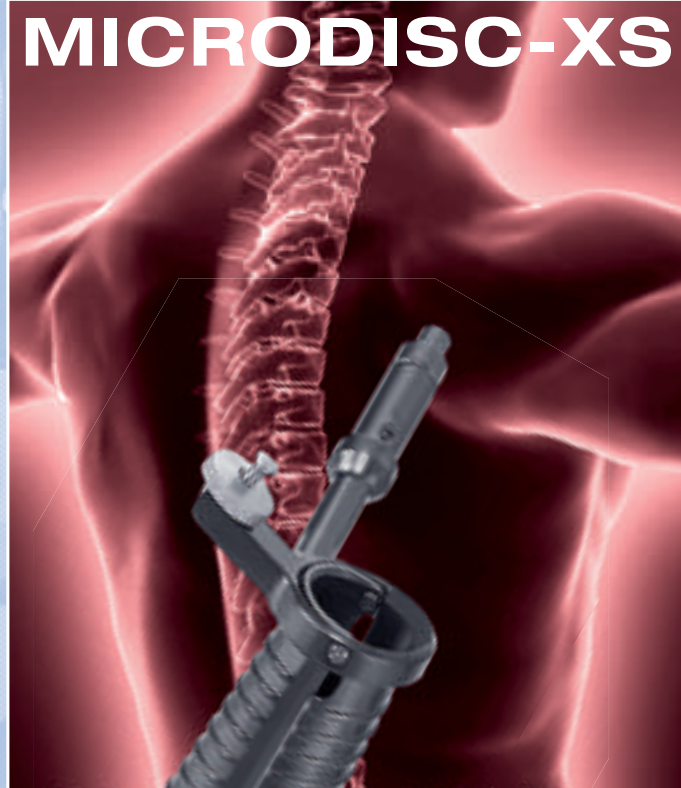

Miniaturisierte (XS) Mikrodiskektomie
Miniaturized (XS) micro-discectomy
Microdiscectomía miniaturizada (XS)
Microdiscectomie miniaturisé (XS)
Microdiscectomia miniaturizzata (XS)

entwickelt in Zusammenarbeit mit:
 developed in cooperation with:
 desarrollado en colaboración con:
 développée en collaboration avec:
 sviluppato in collaborazione con:

Prof. Dr. med. Luca Papavero
 Neurochirurg · Klinik für Spinale Chirurgie · Klinikum Eilbek
 Dehnhaide 120 · 22081 Hamburg

**B01**

Miniaturisierte (XS) Mikrodiskektomie
Miniaturized (XS) Micro-Discectomy
Microdiscectomía miniaturizada (XS)
Microdiscectomie miniaturisé (XS)
Microdiscectomia miniaturizzata (XS)

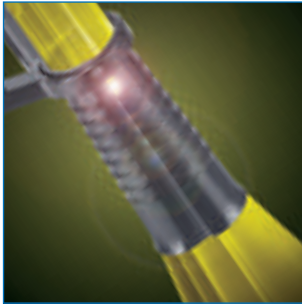

- ▶ Die zunehmende Spreizung in der Tiefe gewährleistet trotz des miniaturisierten Zugangs eine ausreichende Darstellung des operativen Zielgebietes.
- ▶ Die Spreizhülse ermöglicht die Einführung von drei Instrumenten einschließlich einer Fräse.
- ▶ The progressive spreading in depth ensures adequate vision of the surgical target area despite the miniaturised approach.
- ▶ The spreading sleeve allows insertion of three instruments including a burr.
- ▶ La dilatación progresiva en la parte inferior garantiza, a pesar del acceso miniaturizado, una imagen suficiente de la zona objetivo operacional.
- ▶ Las vainas desplegadas permiten la introducción de tres instrumentos en una fresa.
- ▶ L'écartement croissant en profondeur garantit une représentation suffisante de la zone opératoire malgré un accès miniaturisé.
- ▶ La spéculum écarteur permet d'introduire trois instruments, en ce compris une fraise.
- ▶ Il divaricamento crescente in profondità assicura una visualizzazione adeguata della zona da operare malgrado l'accesso miniaturizzato.
- ▶ Gli specoli divaricabili consentono l'introduzione di tre strumenti inclusa una fresa.



Miniaturisierte (XS) Mikrodiskektomie
Miniaturized (XS) Micro-Discectomy
Microdiscectomía miniaturizada (XS)
Microdiscectomie miniaturisé (XS)
Microdiscectomia miniaturizzata (XS)

B01

Sprezhülsen mit Kupplung
 Spreading sleeves with connector
 Vainas desplegadas con acoplamiento
 Spéculums écarteur avec accouplement
 Specoli divaricabili con accoppiamento

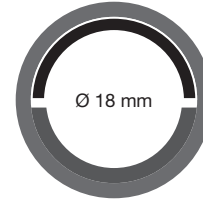
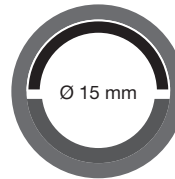

a = 45 mm	57.12.11	57.12.15
a = 55 mm	57.12.12	57.12.16
a = 65 mm	57.12.13	57.12.17
a = 80 mm	57.12.14	57.12.18

Kupplung für Griff (57.12.06) und Haltearme
 Connector for handle (57.12.06) and holding arms
 Acoplamiento para mango (57.12.06) y brazos de soportes
 Accouplement pour manche (57.12.06) et bras de support
 Accoppiamento per manico (57.12.06) e bracci di supporto

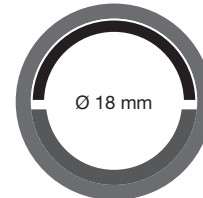
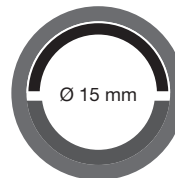

a = 45 mm	57.12.31	57.12.35
a = 55 mm	57.12.32	57.12.36
a = 65 mm	57.12.33	57.12.37
a = 80 mm	57.12.34	57.12.38

MICRODISC-XS



175-176



Haltearme (siehe Seite 175-176)
 Holding arms (see page 175-176)
 Brazos de soportes (véase página 175-176)
 Bras de support (voir page 175-176)
 Bracci di supporto (vedi pagina 175-176)



siehe Seite
 see page
 véase página
 voir page
 vedi pagina

**B01**

Miniaturisierte (XS) Mikrodiskektomie
Miniaturized (XS) Micro-Discectomy
Microdiscectomía miniaturizada (XS)
Microdiscectomie miniaturisé (XS)
Microdiscectomia miniaturizzata (XS)

Dilatations-Sets mit Graduierung
 Dilatation sets with graduation
 Juegos de dilatadores con graduación
 Jeux de dilatateurs avec graduation
 Set per dilatazione con graduazione



3

Ø 15 mm	19 cm – 7½"	57.12.70
Ø 18 mm	19 cm – 7½"	57.12.75



4

Ø 18 mm	19 cm – 7½"	57.12.76
---------	-------------	-----------------

Griff mit Schnellverschluss
 Handle with quick-lock
 Mango con cierre rápido
 Manche avec fermeture rapide
 Manico con chiusura rapida



für
 for
 para 57.12.11-18 / 57.12.31-38
 pour
 per

P

15 cm – 6"	57.12.06
------------	-----------------



Kunststoffgriff (autoklavierbar bis 134 °C bei 3 bar)
 Plastic handle (autoclavable up to 134 °C at 3 bar)
 Mango de plástico (autoclavable hasta 134 °C bajo presión de 3 bar)
 Manche en plastique (autoclavable à 134 °C sous pression de 3 bars)
 Manico di plastica (autoclavabile fino a 134 °C sotto pressione di 3 bar)



Teile
 Parts
 Piezas
 Parties
 Pezzi



Miniaturisierte (XS) Mikrodiskektomie
Miniaturized (XS) Micro-Discectomy
Microdiscectomía miniaturizada (XS)
Microdiscectomie miniaturisé (XS)
Microdiscectomia miniaturizzata (XS)

B01

Saugkanülen
 Suction cannulas
 Cánulas de aspiración
 Canules à aspiration
 Cannule d'aspirazione

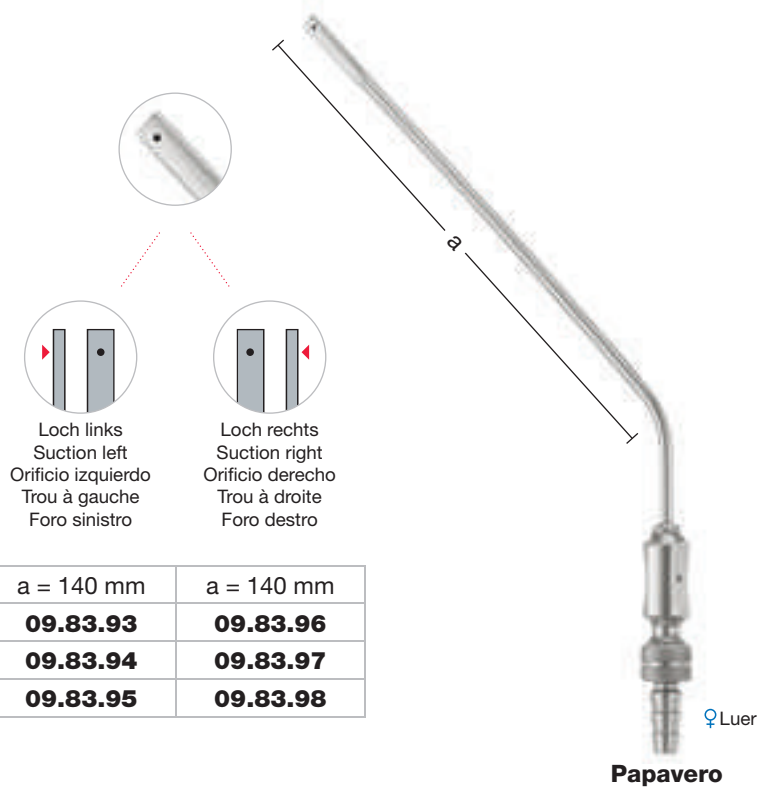

	a = 140 mm	a = 140 mm
Charr. 6	09.83.93	09.83.96
Charr. 8	09.83.94	09.83.97
Charr. 10	09.83.95	09.83.98

Papavero

♀ Luer

MICRODISC-XS

Mikro-Schere
 Micro scissors
 Micro tijera
 Micro ciseaux
 Micro forbice

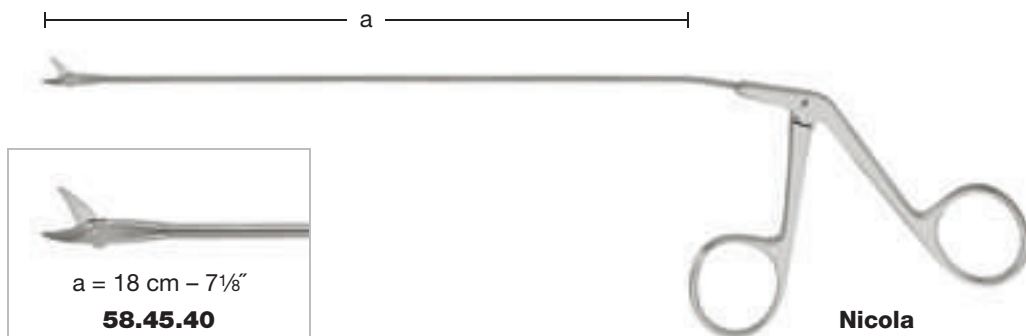

Nicola



B01

Miniaturisierte (XS) Mikrodiskektomie
Miniaturized (XS) Micro-Discectomy
Microdiscectomía miniaturizada (XS)
Microdiscectomie miniaturisé (XS)
Microdiscectomia miniaturizzata (XS)



Nervwurzelnhaken
 Nerve root retractors
 Separadores para raíz nerviosa
 Ecarteurs à racines nerveuses
 Uncini per radici nervose

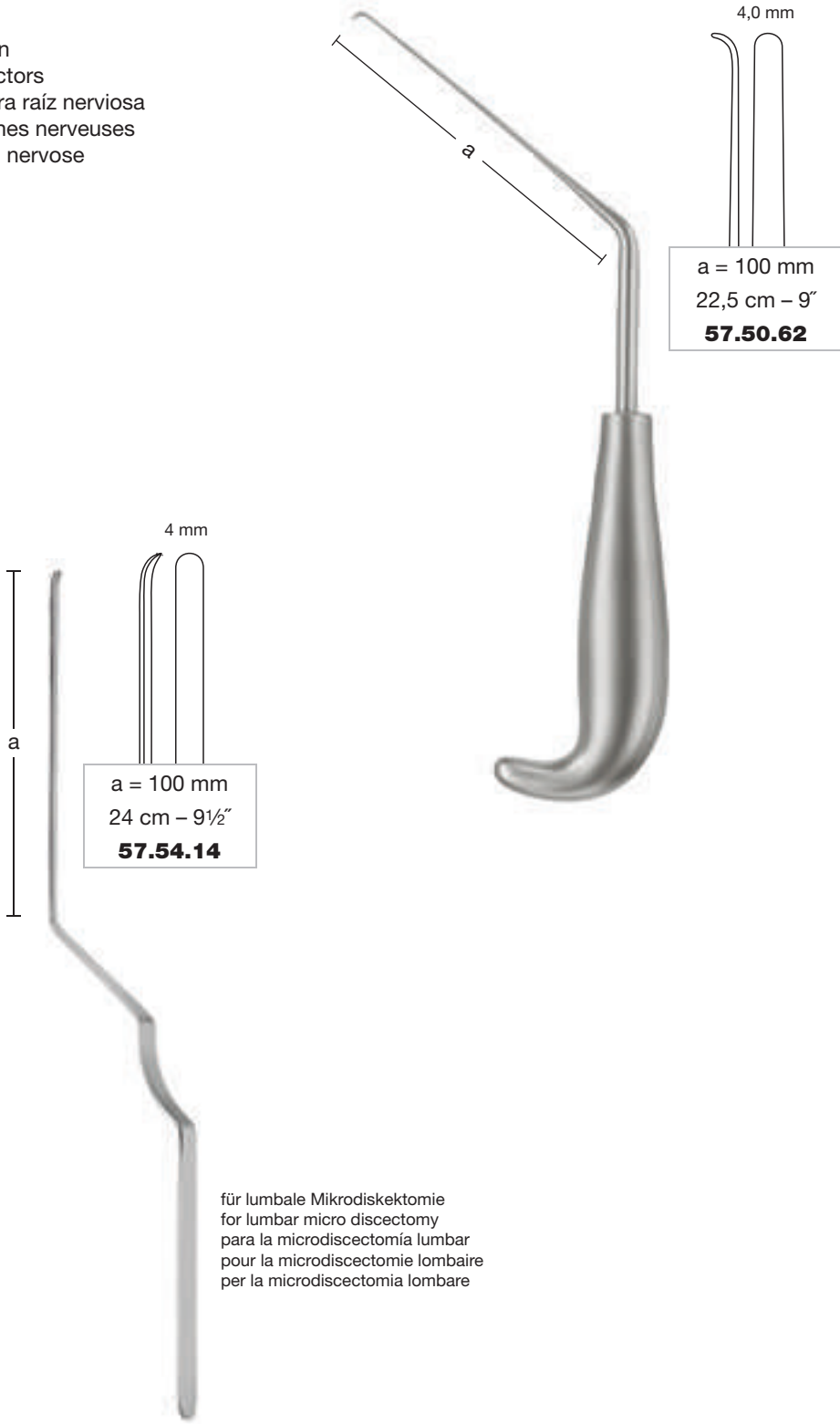

a = 100 mm
 24 cm - 9½"

a = 100 mm
 22,5 cm - 9"

für lumbale Mikrodiskektomie
 for lumbar micro discectomy
 para la microdiscectomía lumbar
 pour la microdiscectomie lombaire
 per la microdiscectomia lombare

Caspar

Miniaturisierte (XS) Mikrodiskektomie
Miniaturized (XS) Micro-Discectomy
Microdiscectomía miniaturizada (XS)
Microdiscectomie miniaturisé (XS)
Microdiscectomia miniaturizzata (XS)

B01

Nervwurzelnhaken
 Nerve root retractors
 Separadores para raíz nerviosa
 Ecarteurs à racines nerveuses
 Uncini per radici nervose

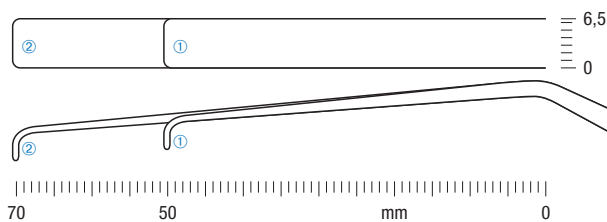

①	a = 50 mm	b = 6,5 mm	18 cm - 7 1/8"	57.50.68
②	a = 70 mm	b = 6,5 mm	18 cm - 7 1/8"	57.50.70



Love-Papavero

Bandscheibenrongeure
 Rongeurs for intervertebral discs
 Pinzas cortantes para discos intervertebrales
 Rongeurs pour disques intervertébraux
 Pinze spezzatrici per dischi intervertebrali

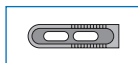

		gefenstert und gezahnt fenestrated and serrated fenestradas y dentadas fenêtrés et dentés finestrati e dentellati
Maulbreite Jaw width Ancho de la boca Largeur des mors Larghezza del morso a	Maullänge Jaw length Longitud de la boca Longueur des mors Lunghezza del morso b	
2 mm	12 mm	57.23.62
3 mm	12 mm	57.23.63
4 mm	14 mm	57.23.64



c = 18,5 cm - 7 1/4"

Caspar

MICRODISC-XS

**B01**

Miniaturisierte (XS) Mikrodiskektomie
Miniaturized (XS) Micro-Discectomy
Microdiscectomía miniaturizada (XS)
Microdiscectomie miniaturisé (XS)
Microdiscectomia miniaturizzata (XS)

Mikro-Rongeure
 Micro rongeurs
 Micro pinzas cortantes
 Micro rongeurs
 Micro pinze per laminectomia

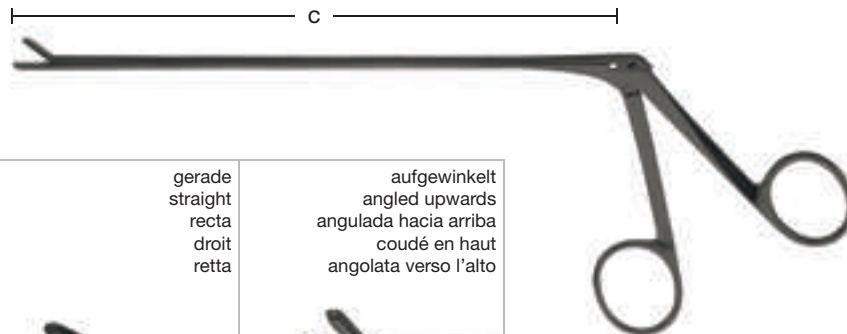

		gerade straight recta droit retta	aufgewinkelt angled upwards angulada hacia arriba coudé en haut angolata verso l'alto
Maulbreite Jaw width Ancho de la boca Largeur des mors Larghezza del morso	Maullänge Jaw length Longitud de la boca Longueur des mors Lunghezza del morso		
a	b	magic cut 30° c = 16 cm - 6¼"	magic cut 30° c = 16 cm - 6¼"
2 mm	5 mm	57.11.80	57.11.81

Micro-Cushing

Lange Standzeit, hohe Oberflächenhärte und blendfreie Oberfläche
 Long lasting cutting ability, high surface hardness and non-dazzling surface
 Máxima duración del corte, alta dureza de la superficie y superficie antideslumbrante
 Longue durée de vie, grande dureté de la surface et surface non-éblouissante
 Massima durata del taglio, alta durezza della superficie e superficie antiriflesso

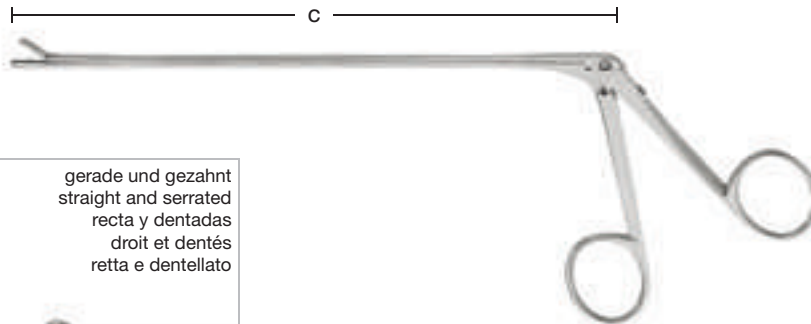
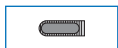

		gerade und gezahnt straight and serrated recta y dentadas droit et dentés retta e dentellato
Maulbreite Jaw width Ancho de la boca Largeur des mors Larghezza del morso	Maullänge Jaw length Longitud de la boca Longueur des mors Lunghezza del morso	
a	b	magic cut 30° c = 16 cm - 6¼"
2 mm	5 mm	57.11.82

Micro-Cushing

Zerlegbare Stanzen mit Silikongriff
Dismantable rongeurs with silicone handle
Pinzas saca-bocadas desmontable con mango de silicona
Pincas emporte-pièce démontables avec manche en silicone
Laminotomi smontabili con manico in silicone



b

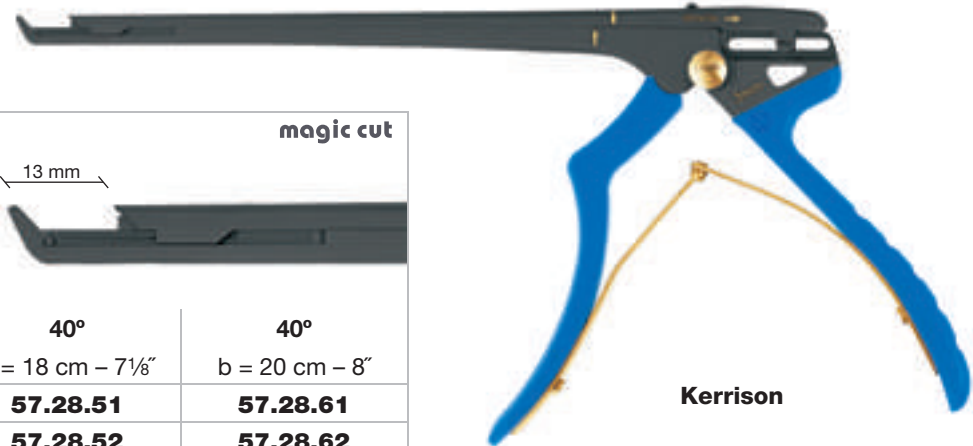

Stanzbreite Jaw width Ancho del corte Largeur des mors Larghezza de morso	magic cut	
	40° b = 18 cm – 7 1/8"	40° b = 20 cm – 8"
1 mm	57.28.51	57.28.61
2 mm	57.28.52	57.28.62
3 mm	57.28.53	57.28.63
4 mm	57.28.54	57.28.64
5 mm	57.28.55	57.28.65
6 mm	57.28.56	57.28.66

Kerrison



b

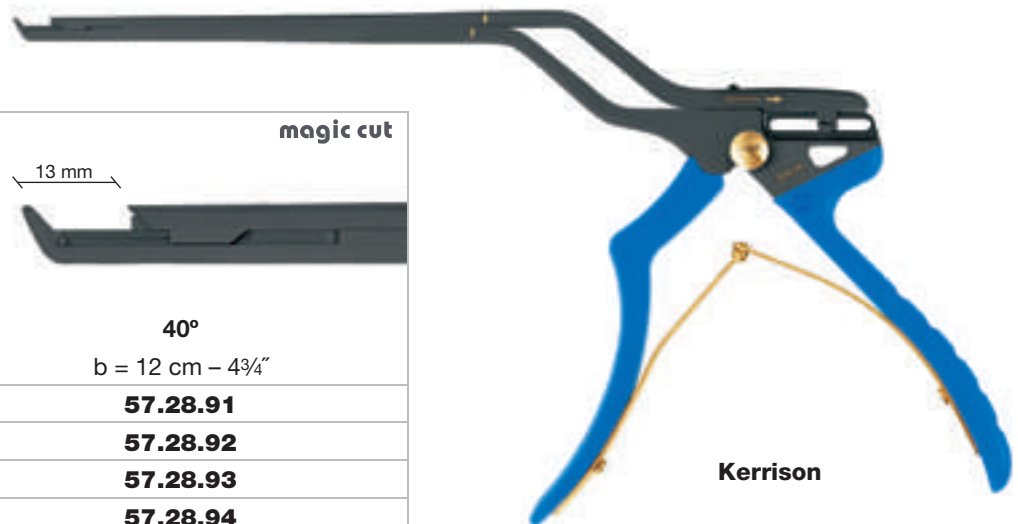

Stanzbreite Jaw width Ancho del corte Largeur des mors Larghezza de morso	magic cut	
	40° b = 12 cm – 4 3/4"	
1 mm	57.28.91	
2 mm	57.28.92	
3 mm	57.28.93	
4 mm	57.28.94	
5 mm	57.28.95	
6 mm	57.28.96	

Kerrison



siehe Seite
see page
véase página
voir page
vedi pagina



mit Auswerfer
with ejector
con expulsor
avec éjecteur
con espulsore



Schmale Stanzplatte = goldene Feder
Narrow footplate = golden spring
Lámina de punzonar estrecha = muelle dorada
Plaque de poinçonnage étroite = ressort doré
Morso sottile = molla dorata



B01

Miniaturisierte (XS) Mikrodissektomie
Miniaturized (XS) Micro-Dissectomy
Microdissectomía miniaturizada (XS)
Microdissectomie miniaturisé (XS)
Microdissectomia miniaturizzata (XS)

Mikro-Dissektoren
 Micro dissectors
 Micro disectores
 Micro-dissecteurs
 Micro-dissettori

Explorationshäkchen
 Exploration hooks
 Ganchitos para exploración
 Crochets pour exploration
 Uncini per esplorazione



1,0 mm

20 cm – 8"
58.33.22

Caspar



1,0 mm

21 cm – 8 1/4"
58.33.24

Caspar



4 mm

6 mm

24,5 cm – 9 3/4"
58.47.01

24,5 cm – 9 3/4"
58.47.02

7 mm

8 mm

24,5 cm – 9 3/4"
58.47.03

24,5 cm – 9 3/4"
58.47.04

Caspar

Minimal-invasive Zugangstechniken
Minimally Invasive Approaches
Técnicas de acceso mínimamente invasivas
Techniques d'accès mini-invasives
Tecniche d'accesso mini-invasive

B01

Das Verfahren der mikroskopisch assistierten perkutanen Nucleotomie (MAPN) bietet bei minimalem Zugangstrauma durch transmuskuläre Dilatation eine optimale Visualisierung des Operationsfeldes in dreidimensionaler Darstellungsweise aufgrund der Verwendung des OP-Mikroskops.

This technique, referred to as microscopically assisted percutaneous nucleotomy (MAPN) allows optimal, three-dimensional visualisation of the surgical field by using a surgical microscope. Access to the spinal canal is provided by a working channel, introduced through transmuscular dilatation.

El método de la así llamada nucleotomía percutánea con asistencia de un microscopio quirúrgico (MAPN) en sus siglas en inglés ofrece, mediante la ayuda de un microscopio quirúrgico una óptima visualización del campo de operación con una representación tridimensional, gracias al empleo del microscopio la dilatación transmuscular.

Outre à réduire le traumatisme chirurgical par la dilatation trans-musculaire, la méthode dénommée de la nucléotomie percutanée assistée au microscope (MAPN) permet une visualisation tridimensionnelle optimale du champ opératoire grâce à l'utilisation du microscope.

Oltre a ridurre il trauma chirurgico con la dilatazione transmuscolare, il metodo della cosiddetta nucleotomia percutanea assistita al microscopio (MAPN) consente una visualizzazione tridimensionale ottimale del campo operatorio grazie all'impiego del microscopio.



Mikroskopisch assistierte perkutane Nucleotomie
Microscopically assisted percutaneous nucleotomy
Nucleotomía percutánea microscópicamente asistida
Nucléotomie percutanée assistée au microscope
Nucleotomia percutanea assistita al microscopio

entwickelt in Zusammenarbeit mit:
 developed in cooperation with:
 desarrollado en colaboración con:
 développée en collaboration avec:
 sviluppato in collaborazione con:

Dr. med. Heinrich Böhm
 Klinik für Wirbelsäulenchirurgie und Querschnittgelähmte
 Zentralklinik Bad Berka GmbH, 99437 Bad Berka

Dr. med. Ralph Greiner-Perth
 Orthopädische Gemeinschaftspraxis und Neurochirurgie
 Orthopädisches Centrum Hochfranken, Klinik Münchberg, 95032 Hof

B01

Mikroskopisch assistierte perkutane Nukleotomie Microscopically Assisted Percutaneous Nucleotomy Nucleotomía percutánea microscópicamente asistida Nucléotomie percutanée assistée au microscope Nucleotomia percutanea assistita al microscopio



- ▶ Die operative Versorgung aller Varianten lumbaler Bandscheibenvorfällen ist ohne qualitative Abstriche im Vergleich zur mikrochirurgischen Technik möglich.
- ▶ Weder eine Wunddrainage, noch eine postoperative Orthesenversorgung ist erforderlich - der Patientenkomfort wird hierdurch verbessert.
- ▶ Zudem ist dieses Zugangsverfahren prinzipiell als minimal-invasive Variante in allen dorsalen Wirbelsäulenabschnitten anwendbar.

- ▶ Without sacrifices in quality the same discal pathologies can be treated as with the standard microsurgical technique.
- ▶ Neither wound drainage nor post-operative orthosis is required - thus enhancing patient comfort.
- ▶ Moreover the same technique allows a less minimally invasive variant of access to all other levels of the posterior spinal column.

- ▶ Este método permite la operación de todos los tipos de hernia discal lumbar sin tener que renunciar a la calidad que ofrece la técnica microquirúrgica.
- ▶ No se necesita realizar ni un drenaje de la herida ni una ortesis postoperatoria - con lo que se aumenta el confort del paciente.
- ▶ Además, este método de acceso es aplicable en todos los sectores dorsales de la columna vertebral como variante mínimamente invasiva.

- ▶ Par rapport à la technique de la microchirurgie, cette méthode permet le traitement opératoire de toutes les variantes d'hernie au disque, sans aucune coupe qualitative.
- ▶ C'est une méthode qui n'exige pas le drainage de la plaie, ni une reconstruction post-opératoire - en améliorant le confort du patient.
- ▶ Cette technique d'abord peut s'appliquer également à tous les segments dorsaux de la colonne vertébrale, comme variante mini-invasives.

- ▶ Rispetto alla tecnica microchirurgica è possibile il trattamento operatorio di tutte le varianti di ernia al disco senza applicare alcun taglio qualitativo.
- ▶ Questo metodo non richiede né il drenaggio della ferita, né una ricostruzione postoperatoria - migliorando il comfort del paziente.
- ▶ Questa tecnica d'accesso può inoltre essere applicata in tutti i segmenti dorsali della colonna vertebrale come variante mini-invasiva.

Trokarhülsen
 Trocar sleeves
 Vainas de trocar
 Fourreaux de trocart
 Guaine per trocar

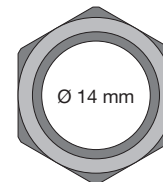
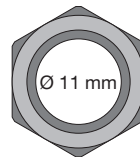

a = 45 mm	57.12.01	57.13.01
a = 55 mm	57.12.02	57.13.02
a = 65 mm	57.12.03	57.13.03



siehe Seite
 see page
 véase página
 voir page
 vedi pagina

Mikroskopisch assistierte perkutane Nukleotomie
Microscopically Assisted Percutaneous Nucleotomy
Nucleotomía percutánea microscópicamente asistida
Nucléotomie percutanée assistée au microscope
Nucleotomia percutanea assistita al microscopio

B01

Trokarhülsenhalter mit Griff
 Holders for trocar sleeves with handle
 Soportes para vainas de trocar con mango
 Supports pour fourreaux de trocart avec manche
 Supporti guaina per trocar con manico



		Ø 11 mm	17,5 cm – 7"	57.12.05
		Ø 14 mm	17,5 cm – 7"	57.13.05

Griff mit Schnellverschluß
 Handle with quick-lock
 Mango con cierre rápido
 Manche avec fermeture rapide
 Manico con chiusura rapida



für
 for
 para 57.12.08 / 57.13.08
 pour
 per

		15 cm – 6"	57.12.06
--	--	------------	-----------------

Trokarhülsenhalter mit Kupplung
 Holders for trocar sleeves with connector
 Soportes para vainas de trocar con acoplamiento
 Supports pour fourreaux de trocart avec accouplement
 Supporti guaina per trocar con accoppiamento

Kupplung für Griff (57.12.06) und Haltearme
 Connector for handle (57.12.06) and holding arms
 Acoplamiento para mango (57.12.06) y brazos de soportes
 Accouplement pour manche (57.12.06) et bras de support
 Accoppiamento per manico (57.12.06) e bracci di supporto



	Ø 11 mm	10 cm – 4"	57.12.08
	Ø 14 mm	10 cm – 4"	57.13.08



Haltearme (siehe Seite 175-176)
 Holding arms (see page 175-176)
 Brazos de soportes (véase página 175-176)
 Bras de support (voir page 175-176)
 Bracci di supporto (vedi pagina 175-176)



Kunststoffgriff (autoklavierbar bis 134 °C bei 3 bar)
 Plastic handle (autoclavable up to 134 °C at 3 bar)
 Mango de plástico (autoclavable hasta 134 °C bajo presión de 3 bar)
 Manche en plastique (autoclavable à 134 °C sous pression de 3 bars)
 Manico di plastica (autoclavabile fino a 134 °C sotto pressione di 3 bar)



für Trokarhülse
 for trocar sleeve
 para vaina de trocar
 pour fourreau de trocart
 per guaina per trocar

M-A-P-N

**B01**

Mikroskopisch assistierte perkutane Nucleotomie
Microscopically Assisted Percutaneous Nucleotomy
Nucleotomía percutánea microscópicamente asistida
Nucléotomie percutanée assistée au microscope
Nucleotomia percutanea assistita al microscopio

Dilatations-Sets mit Graduierung
 Dilatation sets with graduation
 Juegos de dilatadores con graduación
 Jeux de dilataeurs avec graduation
 Set per dilatazione con graduazione



Ø 10 mm 19 cm – 7½" **57.12.10**

©2



Ø 14 mm 19 cm – 7½" **57.13.10**

©3

Saugkanülen
 Suction cannulas
 Cánulas de aspiración
 Canules à aspiration
 Cannule d'aspirazione

Bipolator
 Bipolator
 Bipolator
 Bipolateur
 Bipolatore

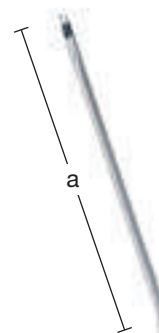
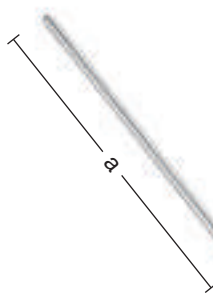

a = 90 mm
 18,5 cm – 7¼"
88.90.25

	a = 90 mm
Charr. 8	09.83.28
Charr. 10	09.83.30



♀ Luer

Frazier (Fergusson)

mit Mandrin
 with guide
 con mandril
 avec mandrin
 con mandrino



Teile
 Parts
 Piezas
 Parties
 Pezzi

Mikroskopisch assistierte perkutane Nukleotomie
Microscopically Assisted Percutaneous Nucleotomy
Nucleotomía percutánea microscópicamente asistida
Nucléotomie percutanée assistée au microscope
Nucleotomia percutanea assistita al microscopio

B01

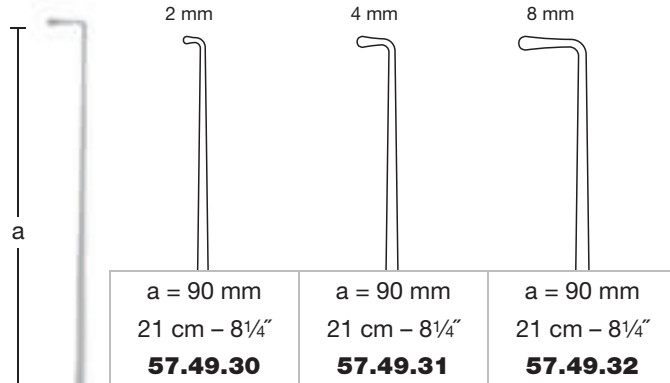

Nervhäkchen
 Nerve hooks
 Ganchitos para nervios
 Crochets à nerfs
 Uncini per nervi



Nervwurzelhaken
 Nerve root retractor
 Separador para raíz nerviosa
 Ecarteur à racines nerveuses
 Uncino per radici nervose

M-A-P-N

**B01**

Miniaturisierte (XS) Mikrodissektomie
Miniaturized (XS) Micro-Dissectomy
Microdissectomía miniaturizada (XS)
Mikrodissektomie miniature (XS)
Mikrodissektomie miniaturizzata (XS)

21
8
20
19
18
7
17
16
6
15
14
5
13
5
12
11
4
10
9
3
7
6
2
5
4
3
1
2
1
cm
inch

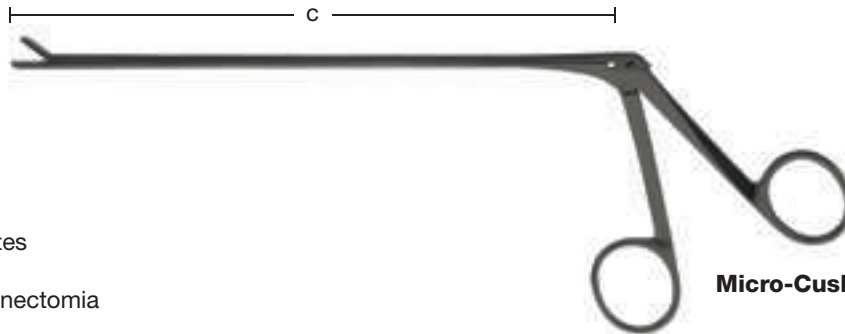
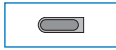
**Micro-Cushing**

Mikro-Rongeur
 Micro rongeurs
 Micro pinzas cortantes
 Micro rongeurs
 Micro pinze per laminectomia

		gerade straight recta droit retta	aufgewinkelt angled upwards angulada hacia arriba coudé en haut angolata verso l'alto	gerade und gezahnt straight and serrated recta y dentadas droit et dentés retta e dentellato
Maulbreite Jaw width Ancho de la boca Largeur des mors Larghezza del morso a	Maullänge Jaw length Longitud de la boca Longueur des mors Lunghezza del morso b			
		magic cut 30° c = 16 cm - 6¼"	magic cut 30° c = 16 cm - 6¼"	magic cut 30° c = 16 cm - 6¼"
2 mm	5 mm	57.11.80	57.11.81	57.11.82



Lange Standzeit, hohe Oberflächenhärte und blendfreie Oberfläche
 Long lasting cutting ability, high surface hardness and non-dazzling surface
 Máxima duración del corte, alta dureza de la superficie y superficie antideslumbrante
 Longue durée de vie, grande dureté de la surface et surface non-éblouissante
 Massima durata del taglio, alta durezza della superficie e superficie antiriflesso

Rongeur
 Rongeurs
 Pinzas cortantes
 Rongeurs
 Pinze per laminectomia

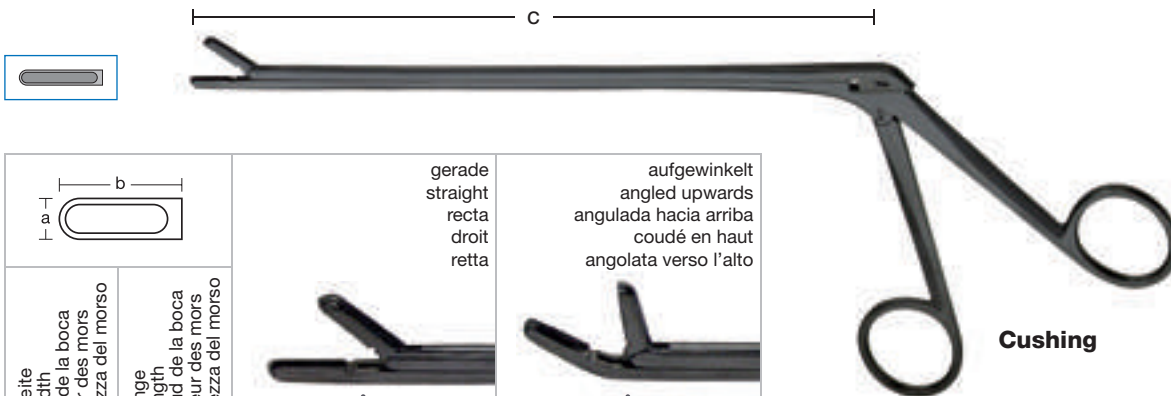
**Cushing**

		gerade straight recta droit retta	aufgewinkelt angled upwards angulada hacia arriba coudé en haut angolata verso l'alto
Maulbreite Jaw width Ancho de la boca Largeur des mors Larghezza del morso a	Maullänge Jaw length Longitud de la boca Longueur des mors Lunghezza del morso b		
		magic cut c = 18 cm - 7⅛"	magic cut 30° c = 18 cm - 7⅛"
2 mm	10 mm	57.11.90	57.11.91



Vergrößerung
 Magnification
 Engrandecimiento
 Agrandissement
 Ingrandimento

Zerlegbare Stanzen mit Silikongriff
Dismantable rongeurs with silicone handle
Pinzas saca-bocadas desmontable con mango de silicona
Pincas emporte-pièce démontables avec manche en silicone
Laminotomi smontabili con manico in silicone



b

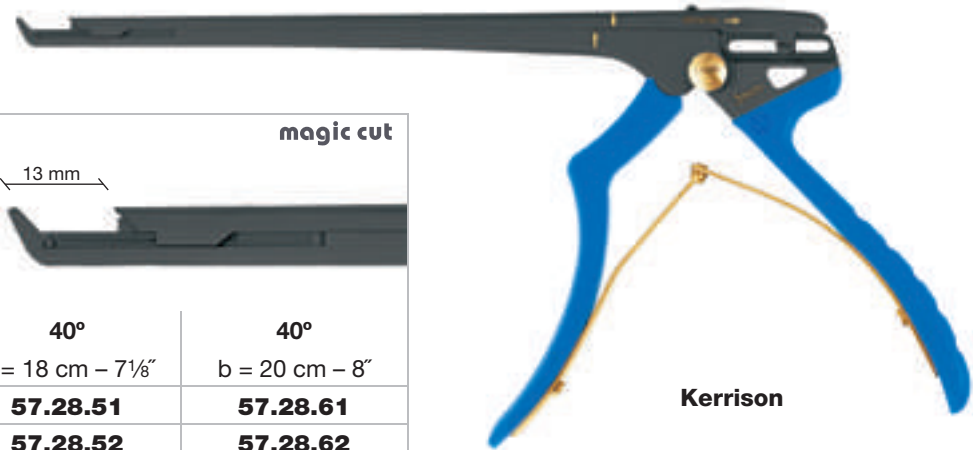

Stanzbreite Jaw width Ancho del corte Largeur des mors Larghezza de morso	magic cut	
	40° b = 18 cm – 7 1/8"	40° b = 20 cm – 8"
1 mm	57.28.51	57.28.61
2 mm	57.28.52	57.28.62
3 mm	57.28.53	57.28.63
4 mm	57.28.54	57.28.64
5 mm	57.28.55	57.28.65
6 mm	57.28.56	57.28.66

Kerrison



b

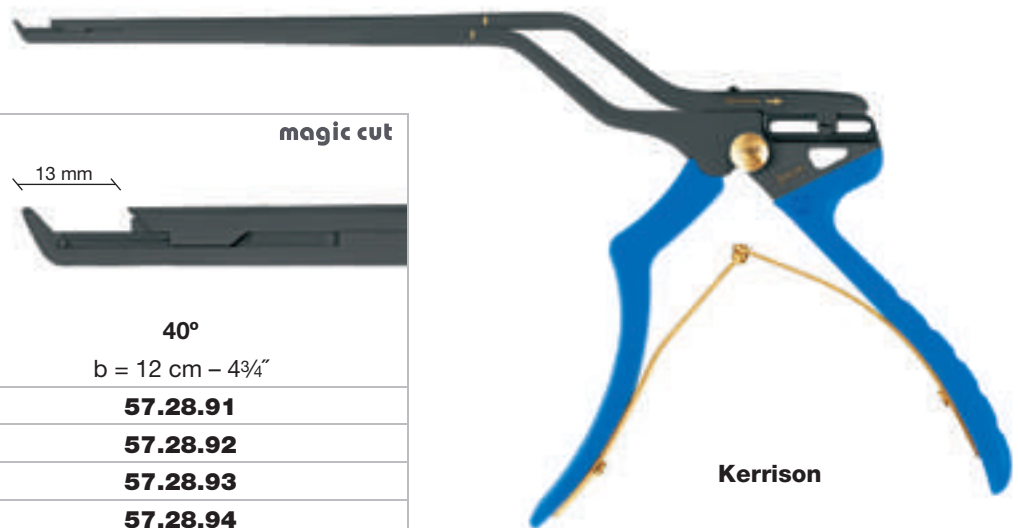

Stanzbreite Jaw width Ancho del corte Largeur des mors Larghezza de morso	magic cut	
	40° b = 12 cm – 4 3/4"	
1 mm	57.28.91	
2 mm	57.28.92	
3 mm	57.28.93	
4 mm	57.28.94	
5 mm	57.28.95	
6 mm	57.28.96	

Kerrison



siehe Seite
see page
véase página
voir page
vedi pagina



mit Auswerfer
with ejector
con expulsor
avec éjecteur
con espulsore



Schmale Stanzplatte = goldene Feder
Narrow footplate = golden spring
Lámina de punzonar estrecha = muelle dorada
Plaque de poinçonnage étroite = ressort doré
Morso sottile = molla dorata



Mikroskopisch assistierte perkutane Nukleotomie
Microscopically Assisted Percutaneous Nucleotomy
Nucleotomía percutánea microscópicamente asistida
Nucléotomie percutanée assistée au microscope
Nucleotomia percutanea assistita al microscopio

B01



Mikro-Dissektoren
 Micro dissectors
 Micro disectores
 Micro-dissecteurs
 Micro-dissettori

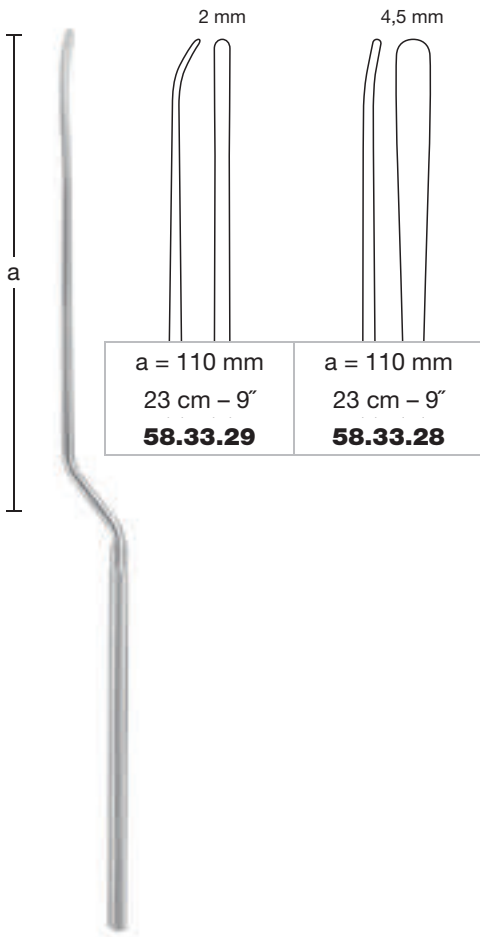

Explorationshäkchen
 Exploration hooks
 Ganchitos para exploración
 Crochets pour exploration
 Uncini per esplorazione

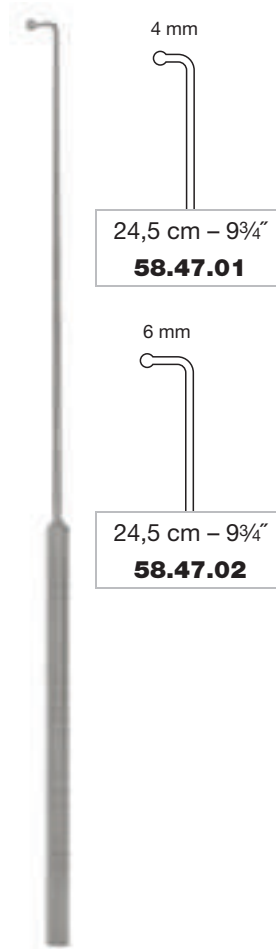

Caspar

Mikro-Schere
 Micro scissors
 Micro tijera
 Micro ciseaux
 Micro forbice

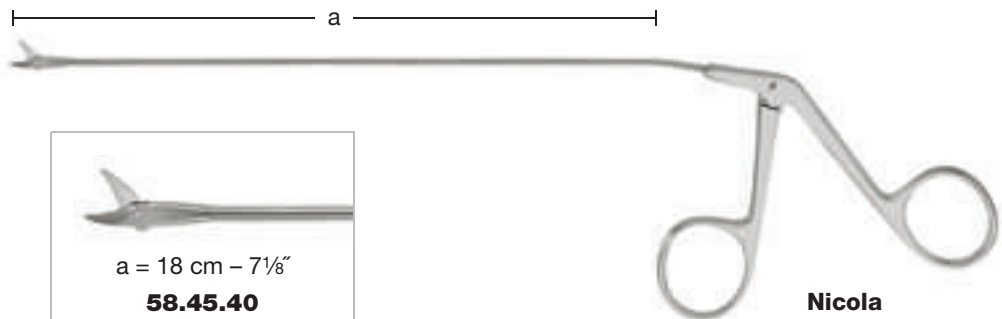

Nicola

Haltearm
Holding Arm
Brazo de soporte
Bras de support
Braccio di supporto

B01

Haltearm
 Holding arm
 Brazo de soporte
 Bras de support
 Braccio di supporto



Kupplung
 Connector
 Acoplamiento
 Accouplement
 Accoppiamento



98 cm
57.12.90

Klemmvorrichtung mit Kugelgelenk
 Ball joint clamp
 Dispositivo de apriete con articulación esférica
 Dispositif de blocage avec joint sphérique
 Dispositivo di serraggio con snodo sferico

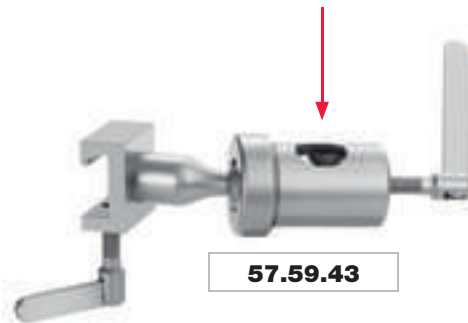

57.59.43



B01

Haltearm
Holding Arm
Brazo de soporte
Bras de support
Braccio di supporto

Haltearm
 Holding arm
 Brazo de soporte
 Bras de support
 Braccio di supporto



65 cm
66.10.20

Kupplung
 Connector
 Acoplamiento
 Accouplement
 Accoppiamento

Adapter mit Schnellverschluss
 Connector with quick-lock
 Adaptador con cierre rápido
 Adaptateur avec fermeture rapide
 Adattatore con chiusura rapida



7 cm - 2¾"
57.12.07



Medicon

In der Standardpositionierung für alle herkömmlichen dorsalen Wirbelsäuleneingriffe können mit dem "THORAMIC"-Set alle transthorakal erforderlichen Zusatzeingriffe bis hin zu Korporektomie und Wirbelkörperersatz ohne Umlagerung durchgeführt werden.

In the standard positioning for all conventional dorsal spinal surgeries the "THORAMIC" set can be used for all required additional transthoracic procedures without repositioning including corporectomy and vertebral body replacement.

En la posición estándar para todas las intervenciones convencionales de la columna vertebral dorsal se puede emplear el set "THORAMIC" en todas las operaciones adicionales toracoscópicas necesarias, incluida la corporectomía y el reemplazo de cuerpos vertebrales, sin necesidad de reposicionar.

En cas de positionnement standard – pour toutes les interventions traditionnelles sur la colonne vertébrale dorsale – le kit "THORAMIC" permet de procéder à toutes les interventions transthoraciques complémentaires requises, y compris les corporectomies et remplacement de corps vertébraux sans changement de position.

Nel posizionamento standard per tutti i comuni interventi alla colonna vertebrale dorsale, con il set "THORAMIC" si possono eseguire tutti gli interventi supplementari necessari a livello transtoracico, inclusa la corporectomia e sostituzione del corpo vertebrale senza riposizionamento.

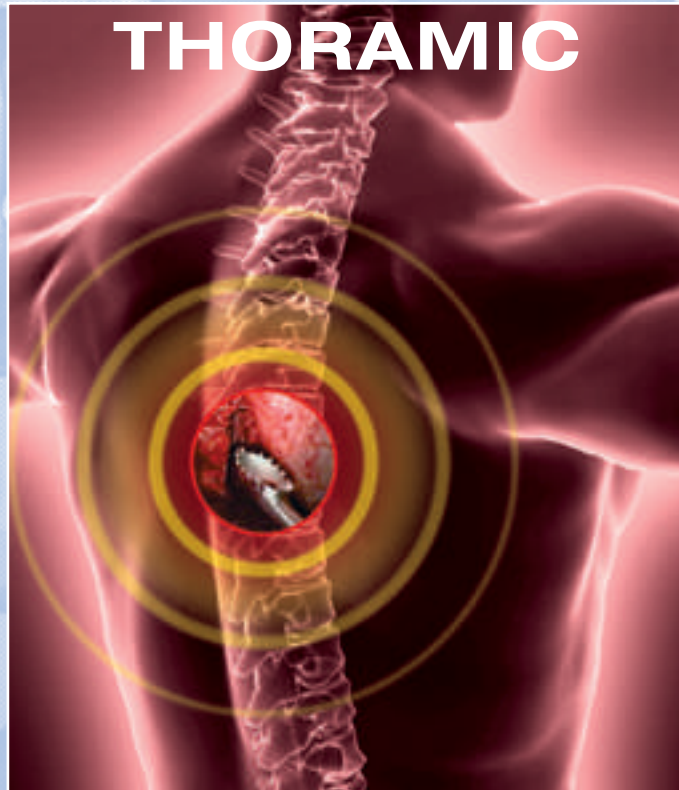

Thorakoskopische Minimal-Invasive Chirurgie
Thoracoscopic minimally invasive surgery
Cirugía toracoscópica mínimamente invasiva
Chirurgie thoracoscopique mini-invasive
Chirurgia toracoscopica mini-invasiva

entwickelt in Zusammenarbeit mit:
 developed in cooperation with:
 desarrollado en colaboración con:
 développée en collaboration avec:
 sviluppato in collaborazione con:

Dr. med. Heinrich Böhm
 Klinik für Wirbelsäulenchirurgie und Querschnittgelähmte
 Zentralklinik Bad Berka GmbH, 99437 Bad Berka

**B01**

Thorakoskopische Minimal-Invasive Chirurgie
Thoracoscopic Minimally Invasive Surgery
Cirugía toracoscópica mínimamente invasiva
Chirurgie thoracoscopique mini-invasive
Chirurgia toracoscopica mini-invasiva

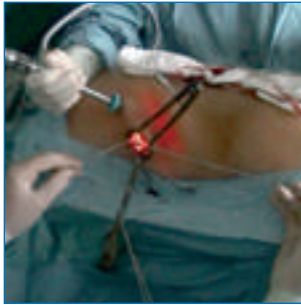

- ▶ Vermeidung der Invasivität einer offenen Thorakotomie
- ▶ Vermeidung des intraoperativen Umlagerns
- ▶ Bessere Orientierung bei in gewohnter Bauchlage positionierter Wirbelsäule

- ▶ Avoiding invasivity of an open thoracotomy
- ▶ Avoiding intraoperative repositioning
- ▶ Better orientation when the spine is in the usual prone position

- ▶ Minimizar la invasión de una toracotomía abierta
- ▶ Prevención del reposicionamiento intraoperatorio
- ▶ Mejor orientación en posiciones pronas habituales de la columna vertebral

- ▶ Permet d'éviter l'invasivité d'une thoracotomie ouverte
- ▶ Permet d'éviter un changement de position pendant l'opération
- ▶ Permet une meilleure orientation sur la colonne vertébrale placée en position ventrale habituelle

- ▶ Si evita l'invasività di una toractomia aperta
- ▶ Si evita un riposizionamento intraoperatorio
- ▶ Migliore orientamento con la colonna vertebrale posizionata nella posizione ventrale abituale

451.04.65

Weitere Informationen finden Sie in unserem Sonderprospekt
 For further information please see our special brochure
 Informaciones adicionales se encuentran en nuestro folleto especial
 Vous trouverez de plus amples informations dans notre prospectus spécial
 Troverete più informazioni nel nostro depliant speciale

Thorakoskopische Minimal-Invasive Chirurgie
Thoracoscopic Minimally Invasive Surgery
Cirugía toracoscópica mínimamente invasiva
Chirurgie thoracoscopique mini-invasive
Chirurgia toracoscopica mini-invasiva

B01

Raspatorium (gezahnt)
 Raspatory (serrated)
 Legra (dentada)
 Rugine (dentelée)
 Periostotomo (dentellata)

Stößel
 Pestle
 Pistón
 Pilon
 Pestello

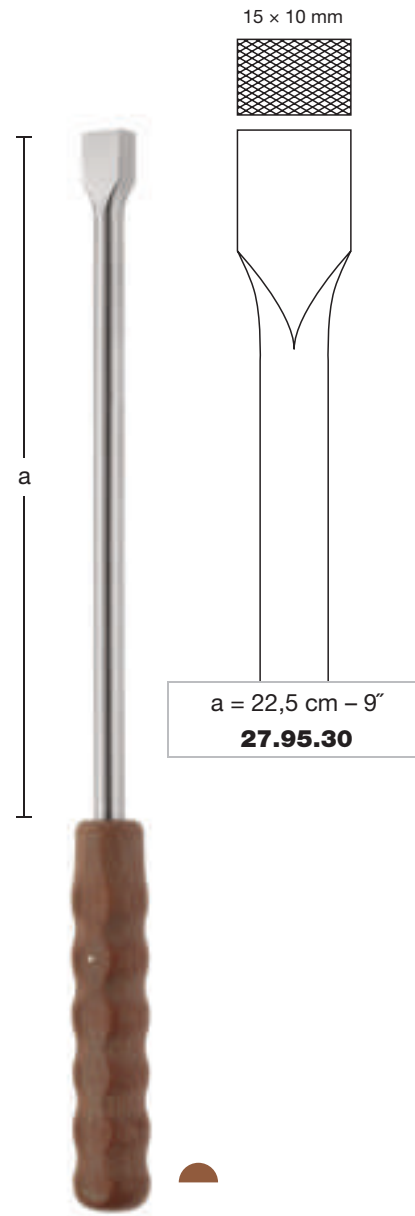
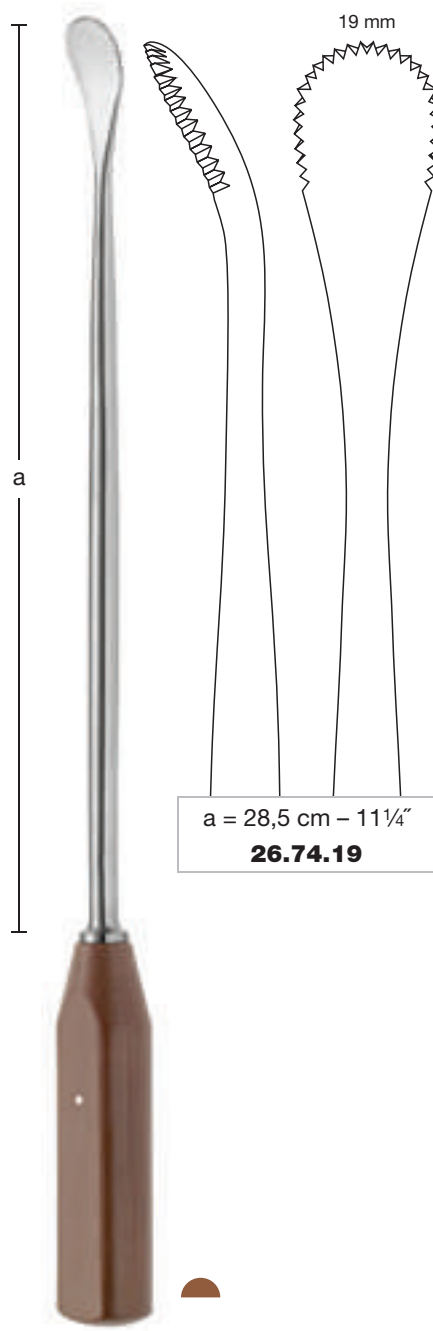

THORAMIC



Kunststoffgriff (autoklavierbar bis 134 °C bei 3 bar) · auch in PROPYLUX erhältlich
 Plastic handle (autoclavable up to 134 °C at 3 bar) · also available in PROPYLUX
 Mango de plástico (autoclavable hasta 134 °C bajo presión de 3 bar) · está disponible también en PROPYLUX
 Manche en plastique (autoclavable à 134 °C sous pression de 3 bars) · aussi disponible en matière PROPYLUX
 Manico di plastica (autoclavabile fino a 134 °C sotto pressione di 3 bar) · disponibile anche in PROPYLUX



Thorakoskopische Minimal-Invasive Chirurgie
Thoracoscopic Minimally Invasive Surgery
Cirugía toroscópica mínimamente invasiva
Chirurgie thoracoscopique mini-invasive
Chirurgia toroscopica mini-invasiva

B01

Flachmeißel mit Graduierung
 Chisels with graduation
 Cinceles con graduación
 Ciseaux burins avec graduation
 Scalpelli con graduazione

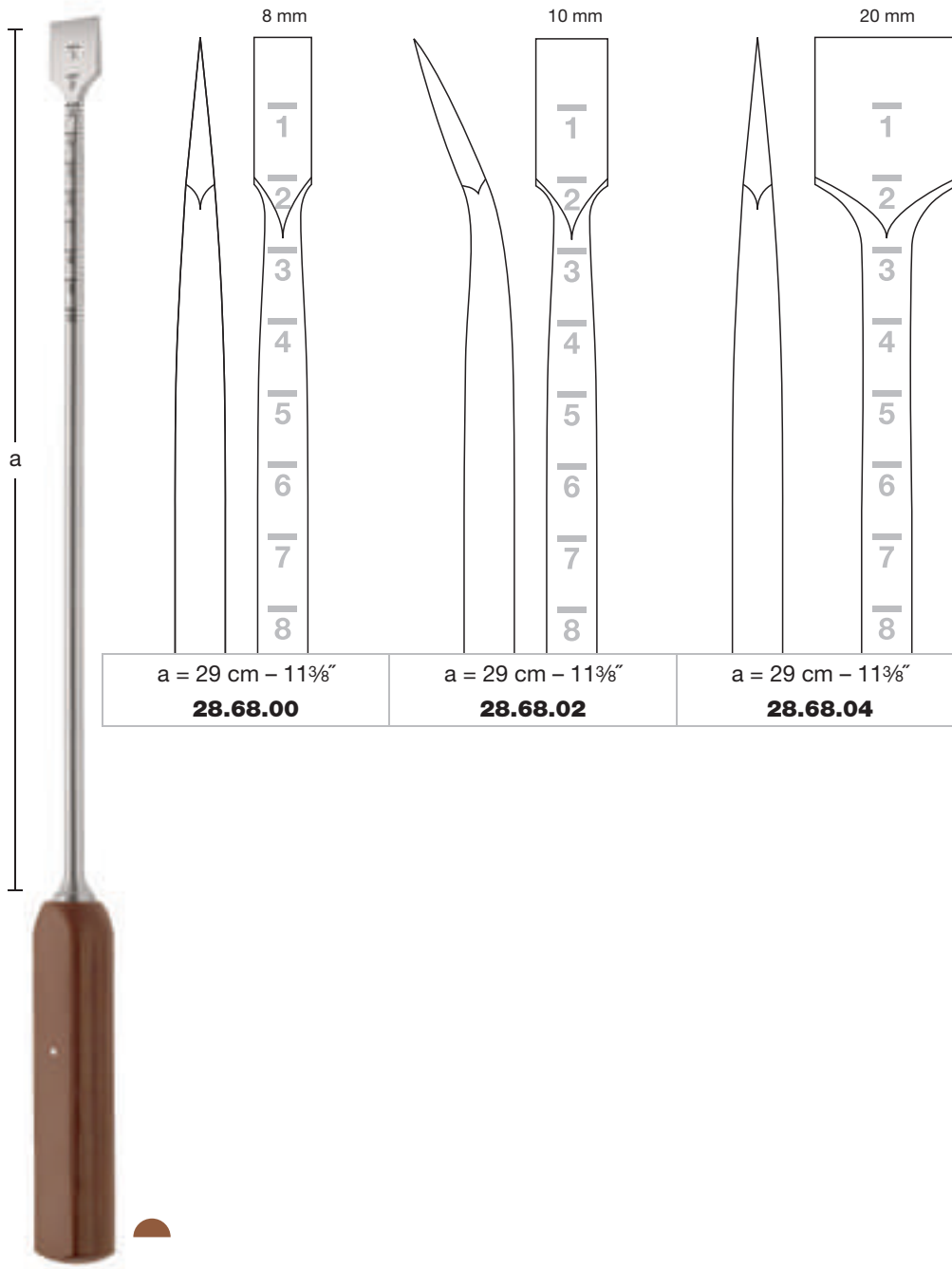

Thorakoskopische Minimal-Invasive Chirurgie
Thoracoscopic Minimally Invasive Surgery
Cirurgía toracoscópica mínimamente invasiva
Chirurgie thoracoscopique mini-invasive
Chirurgia toracoscopica mini-invasiva

B01

Löffel (gezahnt)
 Currettes (serrated)
 Cucharillas (dentada)
 Currettes (dentelée)
 Cucchiai (dentellato)

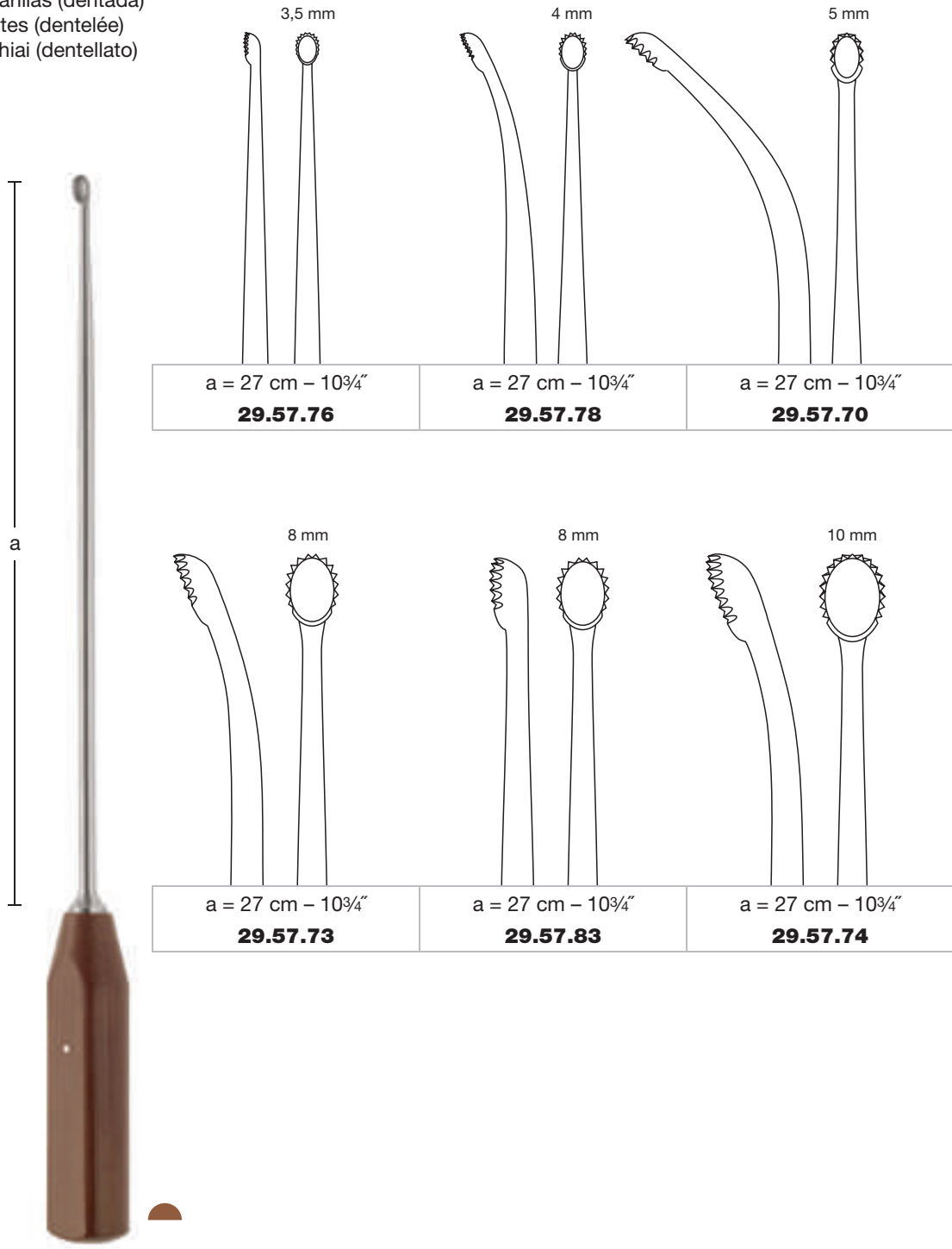

THORAMIC

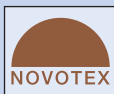

Kunststoffgriff (autoklavierbar bis 134 °C bei 3 bar) · auch in PROPYLUX erhältlich
 Plastic handle (autoclavable up to 134 °C at 3 bar) · also available in PROPYLUX
 Mango de plástico (autoclavable hasta 134 °C bajo presión de 3 bar) · está disponible también en PROPYLUX
 Manche en plastique (autoclavable à 134 °C sous pression de 3 bars) · aussi disponible en matière PROPYLUX
 Manico di plastica (autoclavabile fino a 134 °C sotto pressione di 3 bar) · disponibile anche in PROPYLUX

**B01**

Thorakoskopische Minimal-Invasive Chirurgie
Thoracoscopic Minimally Invasive Surgery
Cirugía toracoscópica mínimamente invasiva
Chirurgie thoracoscopique mini-invasive
Chirurgia toracoscopica mini-invasiva

Saugrohre
 Suction tubes
 Cánulas de aspiración
 Canules d'aspiration
 Cannule per aspirazione

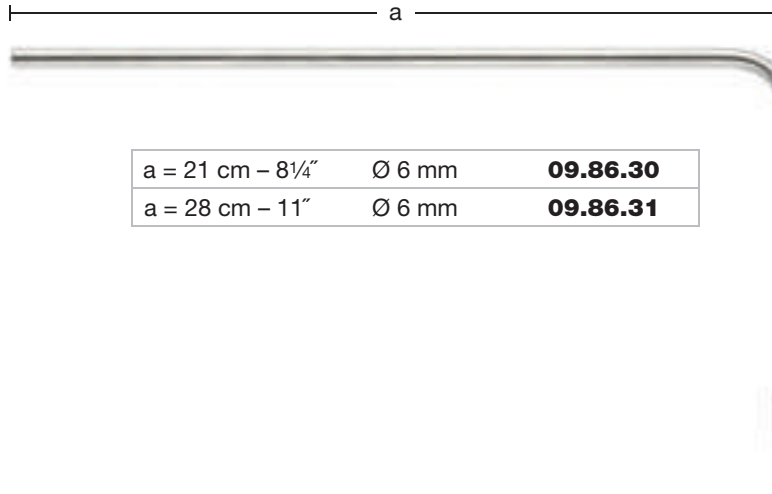

Wirbelsäulenthorakoskop
 Spine thoracoscope
 Toracoscopio para la columna vertebral
 Thoracoscope pour colonne vertébrale
 Toracoscopio per la colonna vertebrale

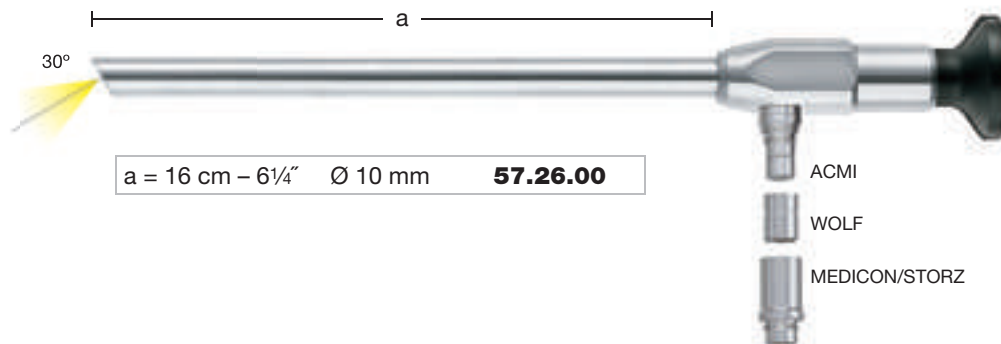

inklusive Adapter zum Anschluß für Lichtleitkabel
 including adapter for connection to fibre optic cable
 con adaptador para la conexión con cable fibra óptica
 avec adaptateur pour brancher le câble conducteur de lumière
 compreso l'adattatore per l'attacco di cavi a fibra ottica



Thorakoskopische Minimal-Invasive Chirurgie
Thoracoscopic Minimally Invasive Surgery
Cirugía toracoscópica mínimamente invasiva
Chirurgie thoracoscopique mini-invasive
Chirurgia toracoscopica mini-invasiva

B01

Spekula
 Specula
 Espéculos
 Spéculums
 Specoli

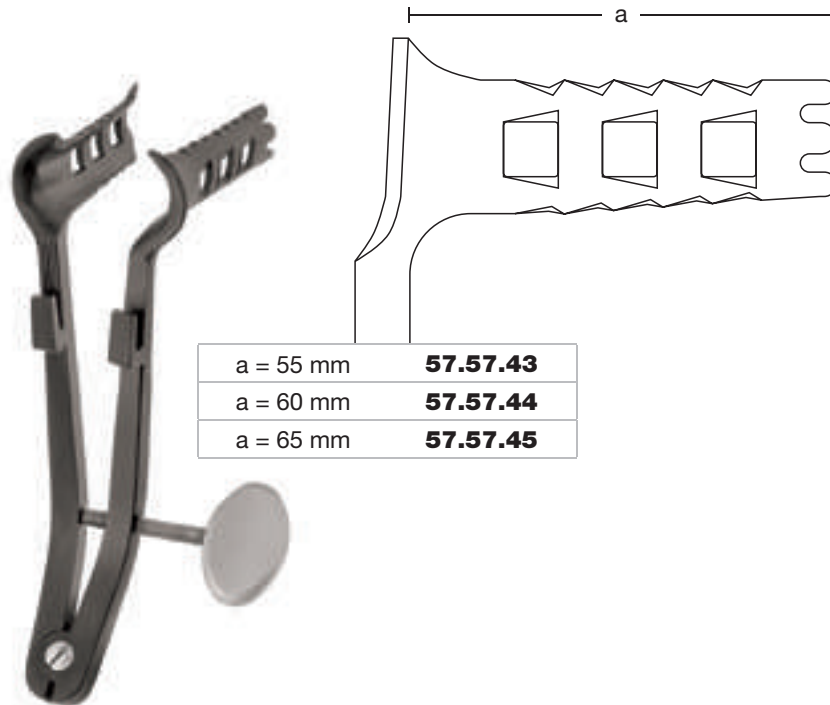

a = 55 mm	57.57.43
a = 60 mm	57.57.44
a = 65 mm	57.57.45

Caspar

Knotenschieber
 Knot pusher
 Guía de nudos
 Pousse-noeuds
 Guida-nodi

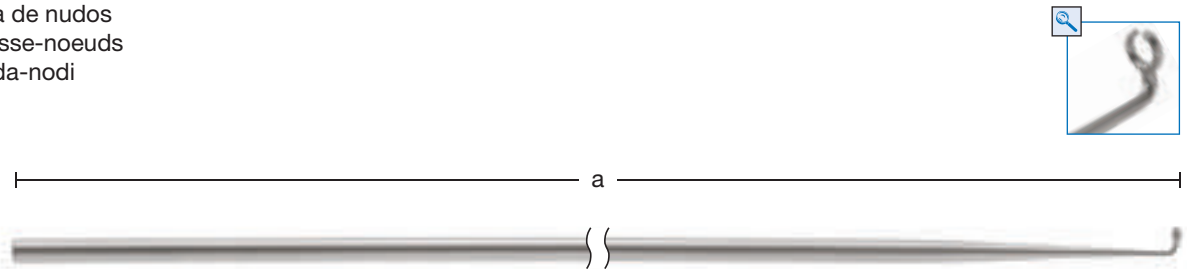

a = 33 cm – 13"	91.06.35
-----------------	-----------------

THORAMIC



Vergrößerung
 Magnification
 Engrandecimiento
 Agrandissement
 Ingrandimento



Thorakoskopische Minimal-Invasive Chirurgie
Thoracoscopic Minimally Invasive Surgery
Cirugía toroscópica mínimamente invasiva
Chirurgie thoroscopique mini-invasive
Chirurgia toroscopica mini-invasiva

B01

Titan-Spatel
 Titanium spatulas
 Espátulas de titanio
 Spatules en titane
 Spatole in titanio

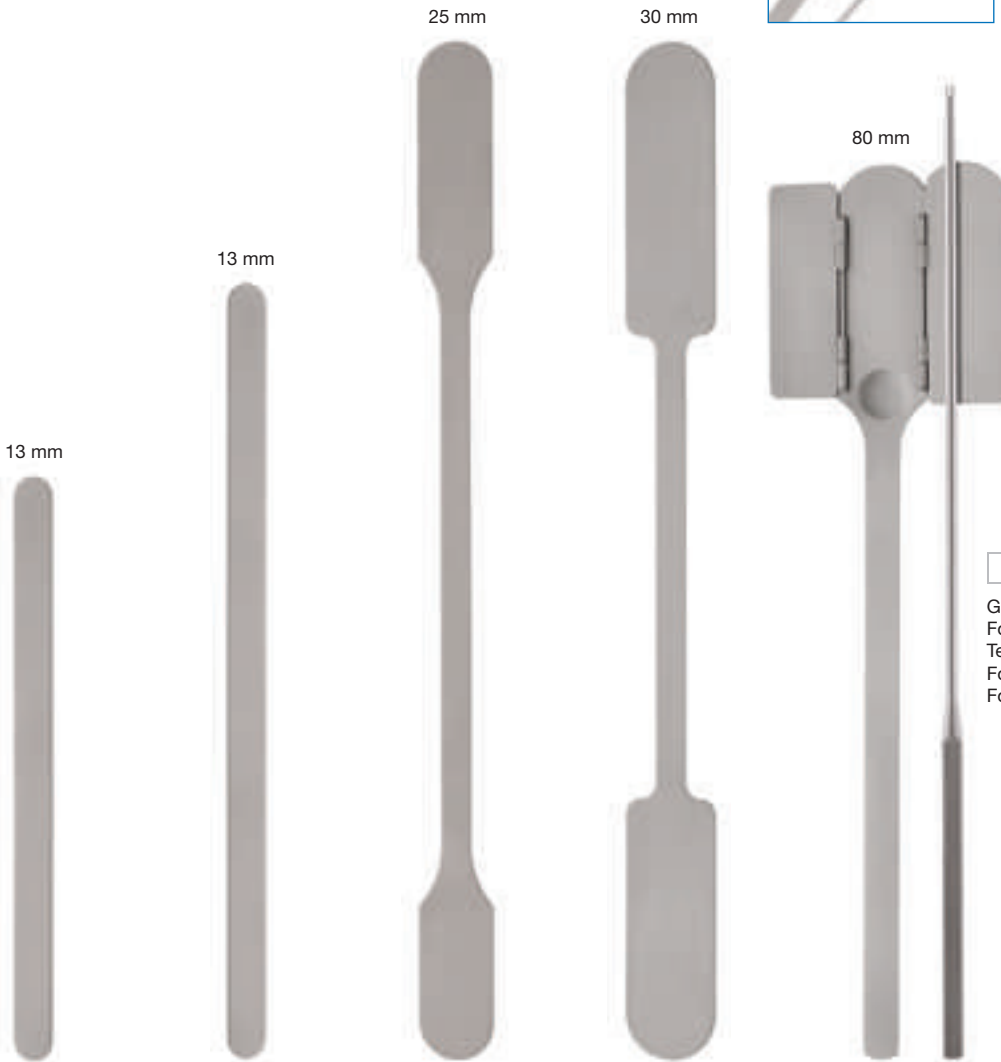

905.71.04

Gabel (allein)
 Fork (only)
 Tenedor (solo)
 Fourchette (seule)
 Forcella (sola)

19 cm – 7½"	25 cm – 10"	33 cm – 13"	33 cm – 13"	29 cm – 11⅝"
57.29.30	57.29.32	57.29.35	57.29.36	57.29.38



mit Gabel
 with fork
 con tenedor
 avec fourchette
 con forcella



biegbar
 malleable
 malleable
 malléables
 malleabile

Dissektoren
 Dissectors
 Disectores
 Dissecteurs
 Dissettori

Elektrode
 Electrode
 Electrodo
 Electrode
 Elettrodo

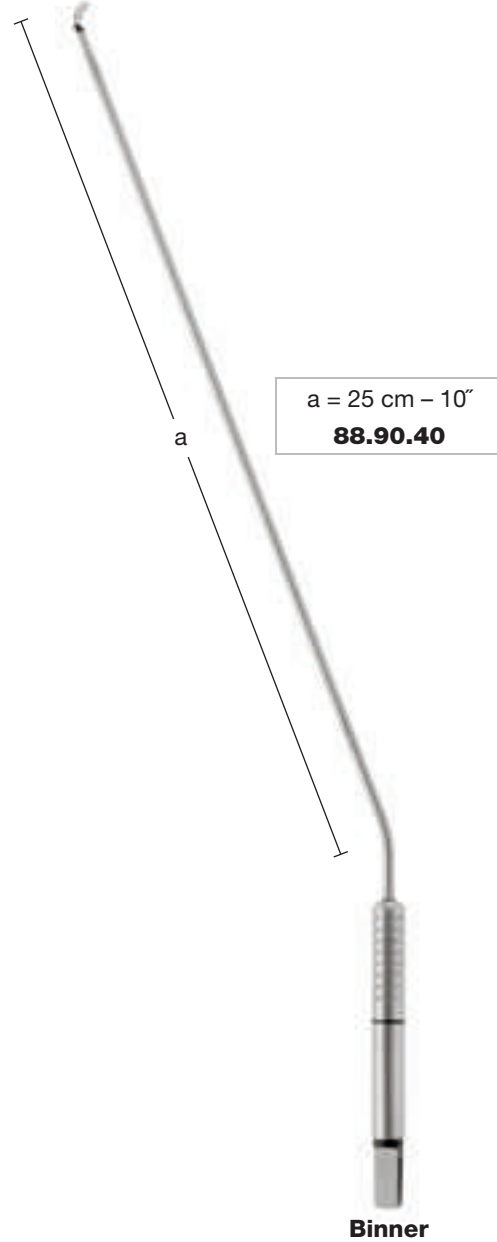
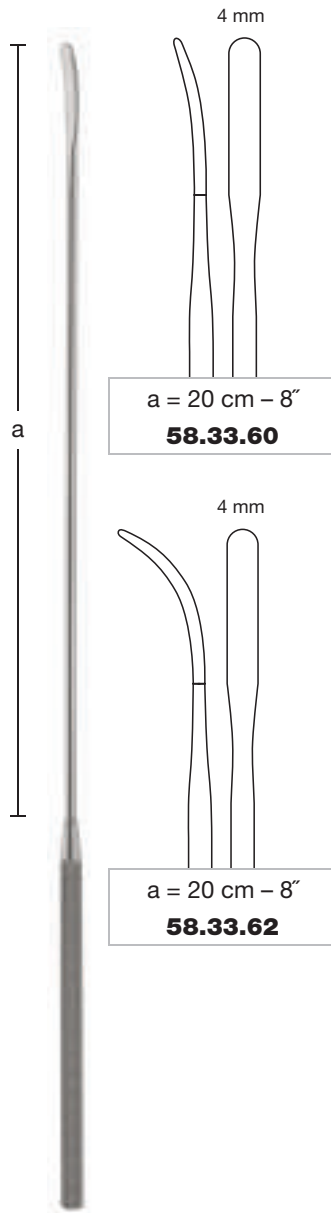

THORAMIC

**B01**

Thorakoskopische Minimal-Invasive Chirurgie
Thoracoscopic Minimally Invasive Surgery
Cirugía toroscópica mínimamente invasiva
Chirurgie thoroscopique mini-invasive
Chirurgia toroscopica mini-invasiva

Stanzen mit Graduierung
 Rongeurs with graduation
 Pinzas saca-bocadas con graduación
 Pincas emporte-pièce avec graduation
 Laminotomi con graduazione

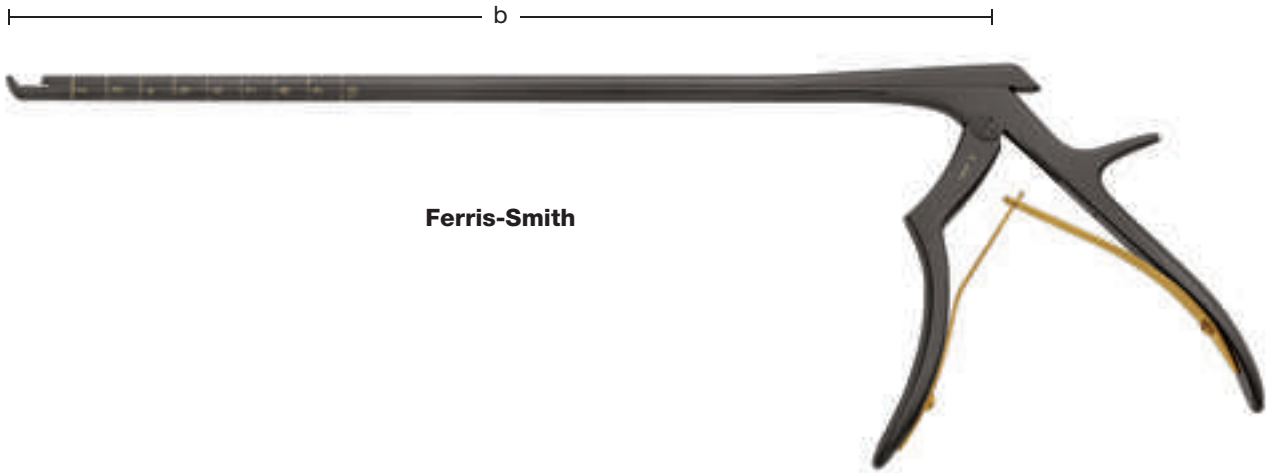
**Ferris-Smith**

 Stanzbreite Jaw width Ancho del corte Largeur des mors larghezza del morso a	 10 mm magic cut 90° b = 30 cm – 11¾"	 9 mm magic cut 40° b = 30 cm – 11¾"	 8 mm magic cut 40° b = 30 cm – 11¾"
	4 mm 57.26.04	4 mm 57.26.10	4 mm 57.26.16
5 mm			57.26.16

magic cut

Lange Standzeit, hohe Oberflächenhärte und blendfreie Oberfläche
 Long lasting cutting ability, high surface hardness and non-dazzling surface
 Máxima duración del corte, alta dureza de la superficie y superficie antideslumbrante
 Longue durée de vie, grande dureté de la surface et surface non-éblouissante
 Massima durata del taglio, alta durezza della superficie e superficie antiriflesso



mit Auswerfer
 with ejector
 con espulsor
 avec éjecteur
 con espulsore



Schmale Stanzplatte = goldene Feder
 Narrow footplate = golden spring
 Lámina de punzonar estrecha = muelle dorada
 Plaque de poinçonnage étroite = ressort doré
 Morso sottile = molla dorata

Rongeur mit Graduierung
 Rongeurs with graduation
 Pinzas cortantes con graduación
 Rongeurs avec graduation
 Pinze per laminectomia con graduazione

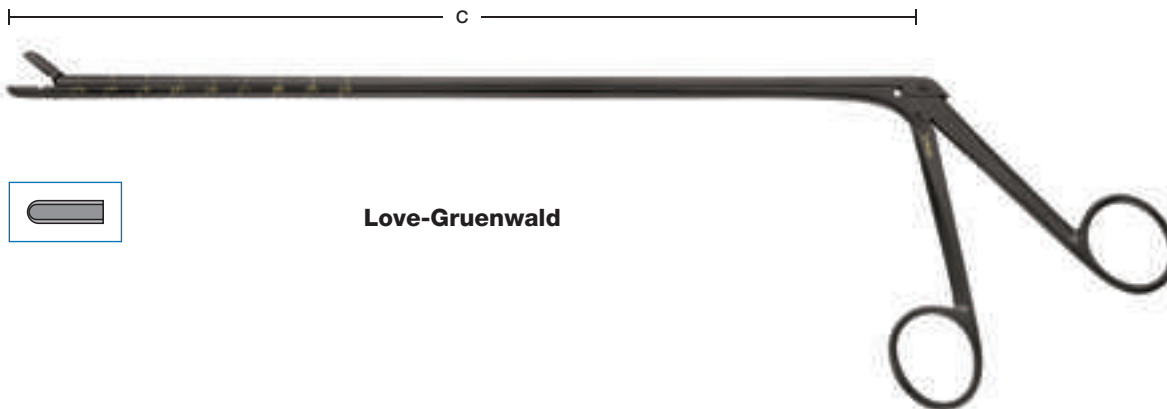

Love-Gruenwald

		gerade straight recta droit retta	links gebogen curved left curva izquierda courbé à gauche curva a sinistra	rechts gebogen curved right curva derecha courbé à droite curva a destra
Maulbreite Jaw width Ancho de la boca Largeur des mors Larghezza del morso	Maullänge Jaw length Longitud de la boca Longueur des mors Lunghezza del morso			
a	b	magic cut	magic cut	magic cut
3 mm	10 mm	30°	30°	
		c = 28 cm – 11"	c = 28 cm – 11"	c = 28 cm – 11"
		57.26.30	57.26.31	57.26.32



Lange Standzeit, hohe Oberflächenhärte und blendfreie Oberfläche
 Long lasting cutting ability, high surface hardness and non-dazzling surface
 Máxima duración del corte, alta dureza de la superficie y superficie antideslumbrante
 Longue durée de vie, grande dureté de la surface et surface non-éblouissante
 Massima durata del taglio, alta durezza della superficie e superficie antiriflesso

THORAMIC



Thorakoskopische Minimal-Invasive Chirurgie
Thoracoscopic Minimally Invasive Surgery
Cirugía toroscópica mínimamente invasiva
Chirurgie thoroscopique mini-invasive
Chirurgia toroscopica mini-invasiva

B01

Rongeur mit Graduierung
 Rongeurs with graduation
 Pinzas cortantes con graduación
 Rongeurs avec graduation
 Pinze per laminectomia con graduazione

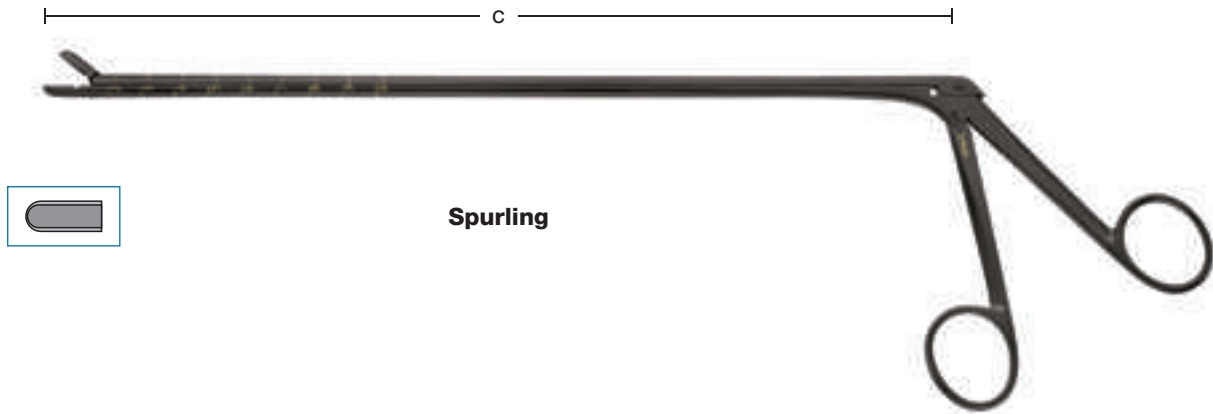
**Spurling**

		gerade straight recta droit retta	abgewinkelt angled downwards angulada hacia abajo coudé en bas angolata verso il basso	aufgewinkelt angled upwards angulada hacia arriba coudé en haut angolata verso l'alto
Maulbreite Jaw width Ancho de la boca Largeur des mors Larghezza del morso	Maullänge Jaw length Longitud de la boca Longueur des mors Lunghezza del morso			
a	b	magic cut	magic cut 30°	magic cut 30°
4 mm	10 mm	c = 28 cm - 11"	c = 28 cm - 11"	c = 28 cm - 11"
		57.26.40	57.26.41	57.26.42

magic cut

Lange Standzeit, hohe Oberflächenhärte und blendfreie Oberfläche
 Long lasting cutting ability, high surface hardness and non-dazzling surface
 Máxima duración del corte, alta dureza de la superficie y superficie antideslumbrante
 Longue durée de vie, grande dureté de la surface et surface non-éblouissante
 Massima durata del taglio, alta durezza della superficie e superficie antiriflesso

Thorakoskopische Minimal-Invasive Chirurgie
Thoracoscopic Minimally Invasive Surgery
Cirugía toracoscópica mínimamente invasiva
Chirurgie thoracoscopique mini-invasive
Chirurgia toracoscopica mini-invasiva

B01

Rongeur mit Graduierung
 Rongeur with graduation
 Pinza cortantes con graduación
 Rongeur avec graduation
 Pinza per laminectomia con graduazione

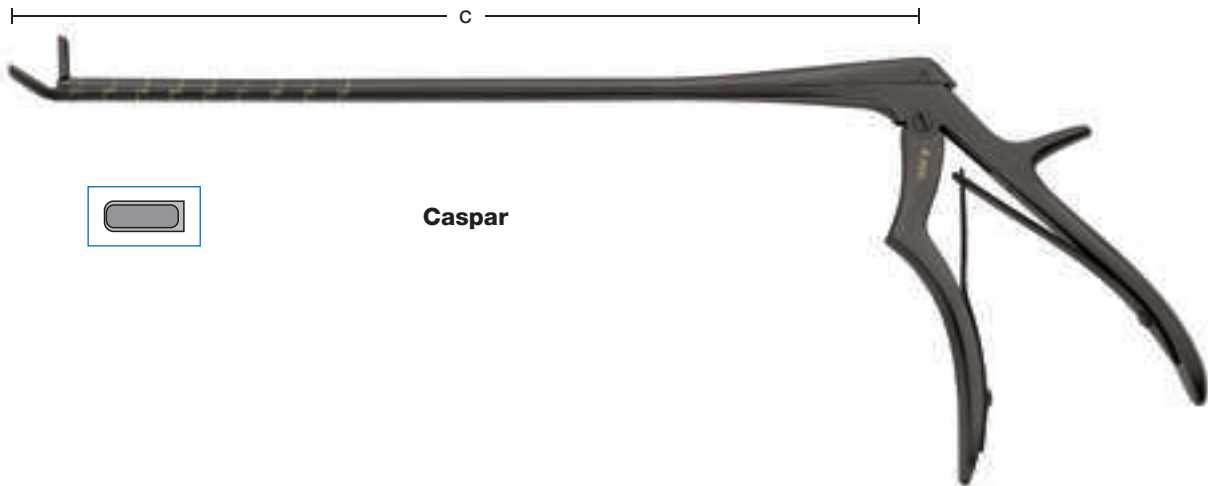

Caspar

		aufgewinkelt angled upwards angulada hacia arriba coudé en haut angolata verso l'alto
Maulbreite Jaw width Ancho de la boca Largeur des mors Larghezza del morso a	Maullänge Jaw length Longitud de la boca Longueur des mors Lunghezza del morso b	
4 mm	10 mm	magic cut 30° c = 28 cm – 11" 57.26.53



Lange Standzeit, hohe Oberflächenhärte und blendfreie Oberfläche
 Long lasting cutting ability, high surface hardness and non-dazzling surface
 Máxima duración del corte, alta dureza de la superficie y superficie antideslumbrante
 Longue durée de vie, grande dureté de la surface et surface non-éblouissante
 Massima durata del taglio, alta durezza della superficie e superficie antiriflesso

THORAMIC



Thorakoskopische Minimal-Invasive Chirurgie
Thoracoscopic Minimally Invasive Surgery
Cirugía toracoscópica mínimamente invasiva
Chirurgie thoracoscopique mini-invasive
Chirurgia toracoscopica mini-invasiva

B01



Schere
 Scissors
 Tijera
 Ciseaux
 Forbice

mit Axialgriff
 with axial handle
 con mango axial
 avec manche axial
 con manico assiale



Nadelhalter
 Needle holder
 Porta-aguja
 Porte-aiguille
 Portaghi

mit Axialgriff
 with axial handle
 con mango axial
 avec manche axial
 con manico assiale



Spreizersysteme für die Wirbelsäule
Spinal Spreading Systems
Sistemas de separadores para la columna vertebral
Systèmes d'écarteurs pour la colonne vertébrale
Sistemi di divaricazione per la colonna vertebrale

B02

Geeignet für alle Wirbelsäulenzugänge ◀
Hohe Variabilität durch auswechselbare Valven ◀

Suitable for all approaches to the spinal column ◀
High variability due to interchangeable blades ◀

Indicado para todos los accesos a la columna vertebral ◀
Gran variabilidad gracias a las valvas intercambiables ◀

Indiqué pour tous les abords à la colonne vertébrale ◀
Flexibilité élevée grâce aux valves interchangeables ◀

Indicato per tutti gli accessi alla colonna vertebrale ◀
Elevata flessibilità grazie a valve intercambiabili ◀



Spread-iT
SPINAL SPREADING SYSTEM



B02

Spreizersysteme für die Wirbelsäule
Spinal Spreading Systems
Sistemas de separadores para la columna vertebral
Systèmes d'écarteurs pour la colonne vertébrale
Sistemi di divaricazione per la colonna vertebrale

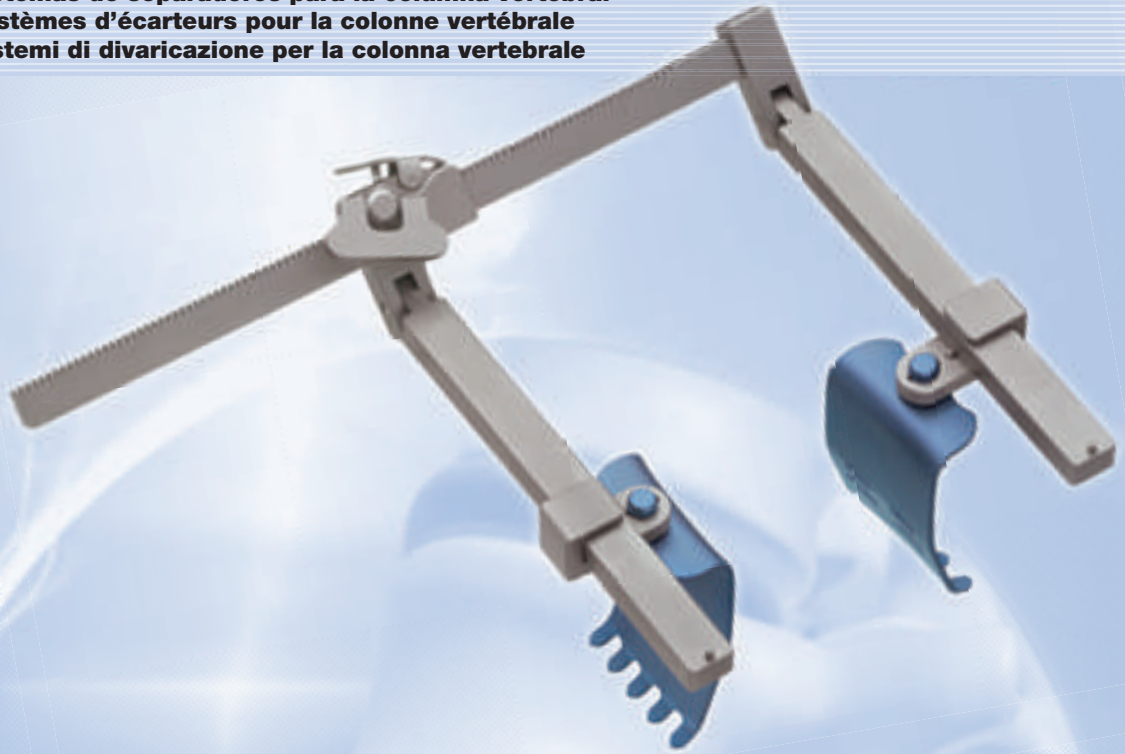

Spread-iT

SPINAL SPREADING SYSTEM



Spread-iT
SPINAL SPREADING SYSTEM

Spreizersysteme für die Wirbelsäule
Spinal Spreading Systems
Sistemas de separadores para la columna vertebral
Systèmes d'écarteurs pour la colonne vertébrale
Sistemi di divaricazione per la colonna vertebrale

B02

Spreizersystem aus Titan mit Gelenk
Titanium spreading system with joint
Sistema de separador de titanio con articulación
Système écarteur en titane avec articulation
Sistema di divaricazione in titanio con articolazione

57.56.71

Spreizer (allein)
Retractor (only)
Separador (solo)
Ecarteur (seul)
Divaricatore (solo)

Ti

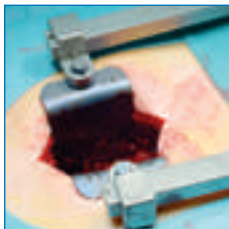
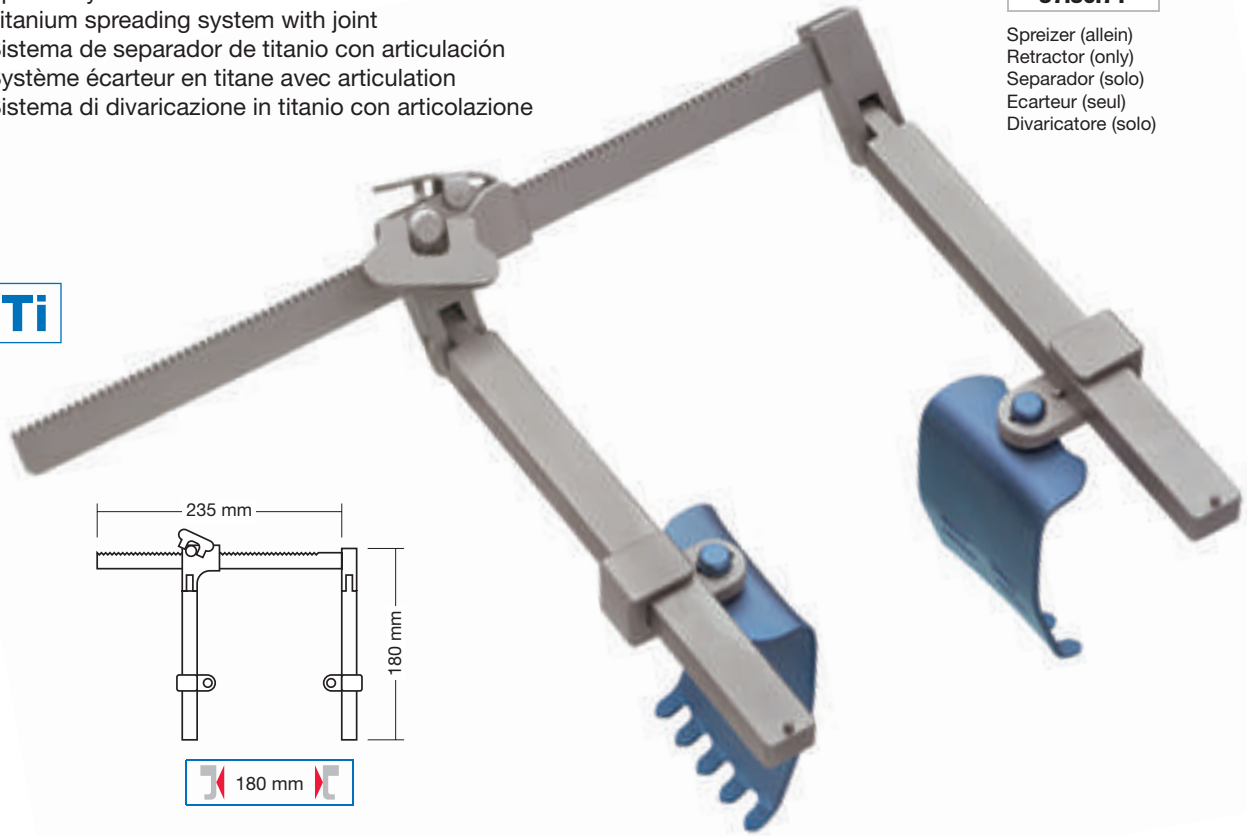

"Spread-iT" Set I

57.56.70

	57.56.69 Blades supports with locking mechanism	2x
	57.56.71 Titanium retractor with joint	1x
	57.56.74 Blades supports with knurled screw	2x
	57.56.76 Titanium hooks with 3 teeth (42 mm)	2x
	57.56.77 Titanium hooks with 4 teeth (52 mm)	2x
	57.56.78 Titanium hooks with 5 teeth (62 mm)	2x
	57.56.79 Titanium hooks with 6 teeth (72 mm)	2x
	57.56.81 Titanium blade with 2 teeth (40 x 30 mm)	1x
	57.56.82 Titanium blade with 2 teeth (40 x 30 mm)	1x
	57.56.84 Titanium blade with 2 teeth (45 x 60 mm)	1x
	57.56.85 Titanium blade with 2 teeth (45 x 60 mm)	1x
	57.56.87 Titanium blades with 5 teeth (50 x 60 mm)	2x
	57.56.88 Titanium blades with 5 teeth (50 x 45 mm)	2x
	57.56.90 Titanium blades with 5 teeth (60 x 60 mm)	2x
	57.56.91 Titanium blades with 5 teeth (60 x 45 mm)	2x
	57.56.93 Titanium blades with 5 teeth (70 x 60 mm)	2x
	57.56.94 Titanium blades with 5 teeth (70 x 45 mm)	2x
	57.56.96 Titanium blades with 5 teeth (80 x 60 mm)	2x
	57.56.97 Titanium blades with 5 teeth (80 x 45 mm)	2x

Satz bestehend aus:
Set consisting of:
Juego compuesto por:
Jeu composé de:
Set composto da:

Ti
Titan
Titanium
Titano
Titane
Titanio



Maximale Spreizweite zwischen den Valven
Maximum spreading width between the blades
Abertura máxima entre las valvas
Aperture maximale entre les valves
Apertura massima tra le valve



Spreizersysteme für die Wirbelsäule
Spinal Spreading Systems
Sistemas de separadores para la columna vertebral
Systèmes d'écarteurs pour la colonne vertébrale
Sistemi di divaricazione per la colonna vertebrale

B02**Spread-iT**
SPINAL SPREADING SYSTEM

Zusätzliche Valven an den Spreizerarmen einsetzbar
 Additional blades can be applied to the spreader arms
 Valvas adicionales pueden ser aplicadas en los brazos del separador
 Possibilité de mise en place de valves supplémentaires sur les bras de l'écarteur
 Possibilità di inserimento di valve supplementari sui bracci del divaricatore

Valvenaufnahme mit Verschuß
 Blade support with locking mechanism
 Soporte de valvas con cierre
 Support de valves avec verrouillage
 Supporto valve con chiusura

**57.56.69**

Valvenaufnahme mit Rändelschraube
 Blade support with knurled screw
 Soporte de valvas con tornillo moleteado
 Support de valves avec vis à tête moletée
 Supporto valve con vite a testa cilindrica zigrinata

**57.56.74**

justierbar
 adjustable
 ajustable
 réglable
 regolabile

Tiefenlehre zur Ermittlung der korrekten Valvenlänge
 Depth gauge to identify the correct length of the blade
 Calibre de profundidad para la averiguación de la longitud correcta de las valvas
 Guide de profondeur pour la reconnaissance de la longueur de valve adaptée
 Calibro di profondità per l'identificazione della lunghezza corretta delle valve

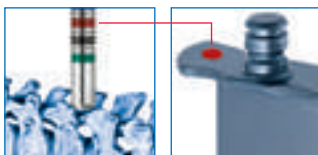

Ø 14 mm

16,5 cm – 6½" **57.57.99**

Valven besitzen eine Farbmarkierung in Form eines Punktes
 Blades are colour-marked showing a point
 Valvas son codificadas por color en forma de un punto
 Valves comportent un code couleur sous la forme d'un point
 Le valve sono dotate di un codice a colore a forma di un punto

Spread-iT
SPINAL SPREADING SYSTEM

Spreizersysteme für die Wirbelsäule
Spinal Spreading Systems
Sistemas de separadores para la columna vertebral
Systèmes d'écarteurs pour la colonne vertébrale
Sistemi di divaricazione per la colonna vertebrale

B02



nur mit Valvenaufnahme (57.56.69)
only with blade support (57.56.69)
solo con soporte de valvas (57.56.69)
seulement avec support de valves (57.56.69)
solo con supporto valve (57.56.69)

Handgriff zum Einbringen von Valven
Handle for insertion of blades
Mango para la inserción de las valvas
Manche pour une mise en place des valves
Manico per l'inserimento delle valve

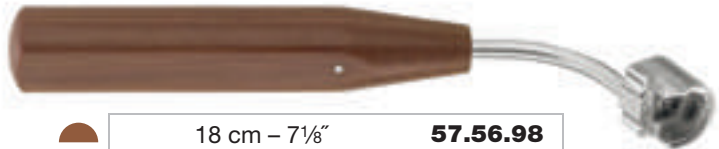

18 cm – 7 1/8"

57.56.98

Rippenvalve aus Titan
Titanium rib blade
Valva para costillas de titanio
Valve pour costaux en titane
Valva costale in titanio

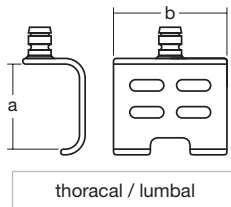

thoracal / lumbal



Ti

a	b	☪	
30 mm	40 mm	2	57.56.75

Haken aus Titan mit Farbmarkierung und Fixierungs-Pin
Titanium hooks with colour code and fixation pin
Ganchos de acero con codificación por color y perno de fijación
Crochets en acier avec code couleur et pivot de fixation
Uncini in acciaio con codice a colore e perno di fissazione

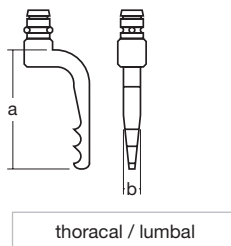

thoracal / lumbal



Ti

a	b	☪		COLOUR
42 mm	6 mm	3	57.56.76	●
52 mm	6 mm	4	57.56.77	●
62 mm	6 mm	5	57.56.78	●
72 mm	6 mm	6	57.56.79	●
92 mm	6 mm	7	57.56.80	●



Kunststoffgriff (autoklavierbar bis 134 °C bei 3 bar)
Plastic handle (autoclavable up to 134 °C at 3 bar)
Mango de plástico (autoclavable hasta 134 °C bajo presión de 3 bar)
Manche en plastique (autoclavable à 134 °C sous pression de 3 bars)
Manico di plastica (autoclavabile fino a 134 °C sotto pressione di 3 bar)



Anzahl der Zähne
Number of teeth
Número de dientes
Nombre de dents
Numero dei denti



Spreizersysteme für die Wirbelsäule
Spinal Spreading Systems
Sistemas de separadores para la columna vertebral
Systèmes d'écarteurs pour la colonne vertébrale
Sistemi di divaricazione per la colonna vertebrale

B02**Spread-iT**
SPINAL SPREADING SYSTEM

Valven aus Titan mit Farbmarkierung
 Titanium blades with colour code
 Valvas de titanio con codificación por color
 Valves en titane avec code couleur
 Valve in titanio con codice a colore

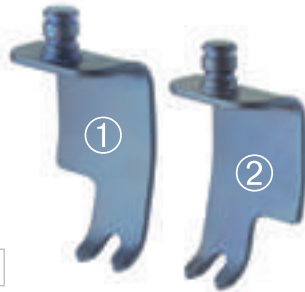
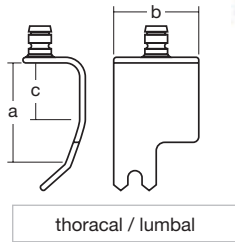

	a	b	c			COLOUR
①	40 mm	30 mm	20 mm	2	57.56.81	●
	45 mm	60 mm	25 mm	5	57.56.84	●
②	40 mm	30 mm	20 mm	2	57.56.82	●
	45 mm	60 mm	25 mm	5	57.56.85	●

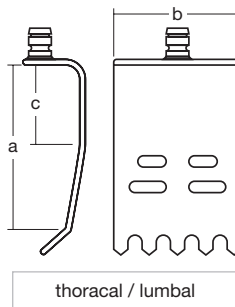

	a	b	c			COLOUR
	50 mm	60 mm	30 mm	6	57.56.87	●
	50 mm	45 mm	30 mm	5	57.56.88	●
	60 mm	60 mm	30 mm	6	57.56.90	●
	60 mm	45 mm	30 mm	5	57.56.91	●
	70 mm	60 mm	35 mm	6	57.56.93	●
	70 mm	45 mm	35 mm	5	57.56.94	●
	80 mm	60 mm	45 mm	6	57.56.96	●
	80 mm	45 mm	45 mm	5	57.56.97	●



Titan
 Titanium
 Titanio
 Titane
 Titanio

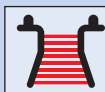

Vergrößerung des Freiraumes im Operationsfeld
 To increase the visibility of the operating area
 Aumento del espacio libre en el campo quirúrgico
 Augmentation de l'espace libre dans le champ opératoire
 Aumento dello spazio libero nel campo operatorio

Spread-iT
SPINAL SPREADING SYSTEM

Spreizersysteme für die Wirbelsäule
Spinal Spreading Systems
Sistemas de separadores para la columna vertebral
Systèmes d'écarteurs pour la colonne vertébrale
Sistemi di divaricazione per la colonna vertebrale

B02

Valven aus PEEK mit Fixierungs-Pin
PEEK blades with fixation pin
Valvas de PEEK con perno de fijación
Valves en PEEK avec pivot de fixation
Valve in PEEK con perno di fissazione



Vollständige Röntgentransparenz
Excellent X-ray transparency
Completamente trasparente a los rayos X
Complètement transparent pour les rayons X
Completamente trasparente ai raggi X

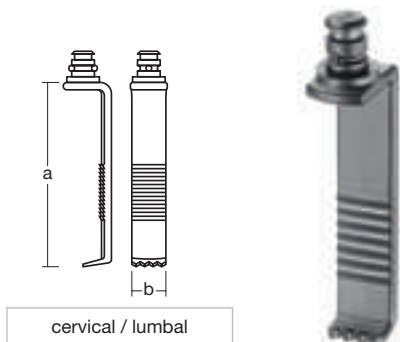

a	b		
40 mm	12 mm	4	57.59.63
45 mm	12 mm	4	57.59.64
50 mm	12 mm	4	57.59.65
55 mm	12 mm	4	57.59.66
60 mm	12 mm	4	57.59.67
65 mm	12 mm	4	57.59.68
75 mm	12 mm	4	57.59.69

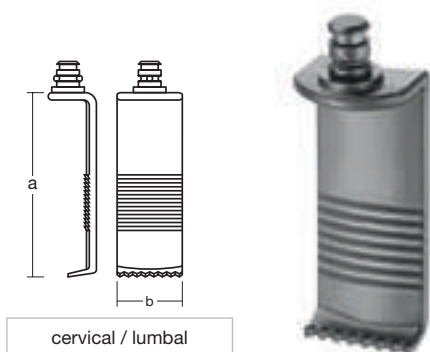

Vollständige Röntgentransparenz
Excellent X-ray transparency
Completamente trasparente a los rayos X
Complètement transparent pour les rayons X
Completamente trasparente ai raggi X

a	b		
40 mm	23 mm	8	57.59.79
45 mm	23 mm	8	57.59.80
50 mm	23 mm	8	57.59.81
55 mm	23 mm	8	57.59.82
60 mm	23 mm	8	57.59.83
65 mm	23 mm	8	57.59.84
75 mm	23 mm	8	57.59.85

Pinzette für Valvenwechsel
Forceps for changing the blades
Pinza para cambiar las valvas
Pince pour le changement des valves
Pinza per cambiare le valve



11,5 cm – 4½" **57.58.87**



Anzahl der Zähne
Number of teeth
Número de dientes
Nombre de dents
Numero dei denti



Spreizersysteme für die Wirbelsäule
Spinal Spreading Systems
Sistemas de separadores para la columna vertebral
Systèmes d'écarteurs pour la colonne vertébrale
Sistemi di divaricazione per la colonna vertebrale

B02**Spread-iT**
SPINAL SPREADING SYSTEM

Spreizersystem aus Titan mit Doppelgelenk
 Titanium spreading system with double joint
 Sistema de separador de titanio con articulación doble
 Système d'écarteur en titane avec articulation double
 Sistema di divaricazione in titanio con articolazione doppia

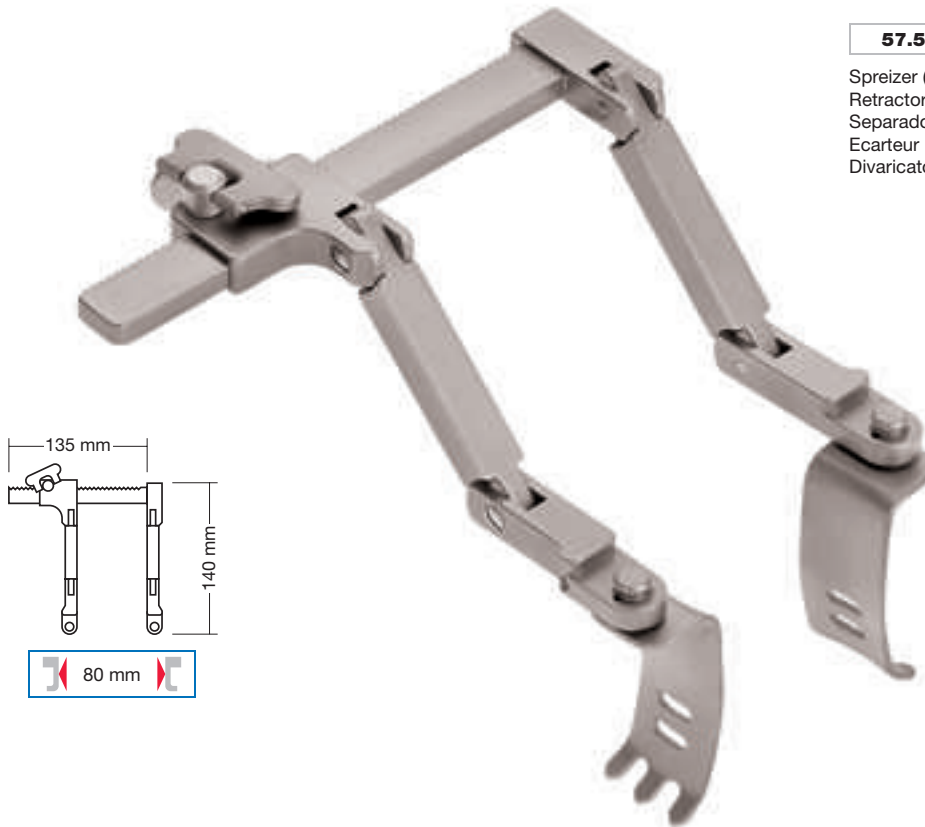
Ti**57.57.66**

Spreizer (allein)
 Retractor (only)
 Separador (solo)
 Ecarteur (seul)
 Divaricatore (solo)

**"Spread-iT" Set II****57.57.65**

	57.57.66 Titanium retractor with double joint	1x
	57.57.67 Titanium blades with 3 teeth (40 x 24 mm)	2x
	57.57.68 Titanium blades with 3 teeth (50 x 24 mm)	2x
	57.57.69 Titanium blades with 3 teeth (60 x 24 mm)	2x
	57.57.70 Titanium blades with 3 teeth (70 x 24 mm)	2x
	57.57.71 Titanium blades with 3 teeth (90 x 24 mm)	2x
	57.57.72 Titanium blades with 3 teeth (110 x 24 mm)	2x
	57.57.73 Titanium blades with 3 teeth (130 x 24 mm)	2x
	57.57.74 Titanium blades with 3 teeth (30 x 24 mm)	2x
	57.57.75 Titanium blades with 3 teeth (35 x 24 mm)	2x
	57.57.77 Titanium blunt blades (40 x 15 mm)	2x
	57.57.78 Titanium blunt blades (50 x 15 mm)	2x
	57.57.79 Titanium blunt blades (60 x 15 mm)	2x
	57.57.80 Titanium blunt blades (70 x 15 mm)	2x

Satz bestehend aus:
 Set consisting of:
 Juego compuesto por:
 Jeu composé de:
 Set composto da:

Ti
 Titan
 Titanium
 Titanio
 Titane
 Titanio



Maximale Spreizweite zwischen den Valven
 Maximum spreading width between the blades
 Ancho de separación máximo entre las valvas
 Ouverture maximale entre les valves
 Apertura massima tra le valve

Spread-iT

SPINAL SPREADING SYSTEM

Spreizersysteme für die Wirbelsäule
Spinal Spreading Systems
Sistemas de separadores para la columna vertebral
Systèmes d'écarteurs pour la colonne vertébrale
Sistemi di divaricazione per la colonna vertebrale

B02

Valven aus Titan mit Farbmarkierung
 Titanium blades with colour code
 Valvas de titanio con codificación por color
 Valves en titane avec code couleur
 Valve in titanio con codice a colore

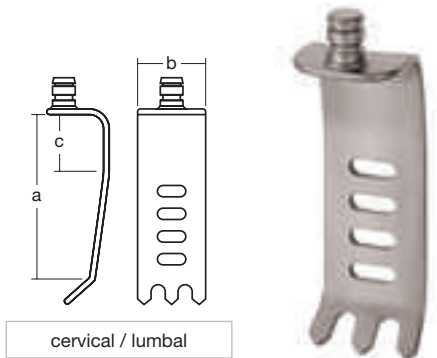

a	b	c		
30 mm	24 mm	10 mm	3	57.57.74
35 mm	24 mm	15 mm	3	57.57.75
40 mm	24 mm	15 mm	3	57.57.67
50 mm	24 mm	30 mm	3	57.57.68
60 mm	24 mm	20 mm	3	57.57.69
70 mm	24 mm	30 mm	3	57.57.70
90 mm	24 mm	50 mm	3	57.57.71
110 mm	24 mm	70 mm	3	57.57.72
130 mm	24 mm	90 mm	3	57.57.73

COLOUR

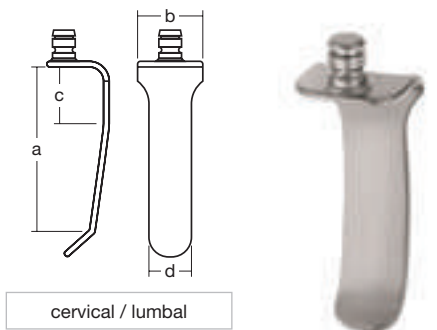

a	b	c	d	
30 mm	24 mm	10 mm	15 mm	57.57.76
40 mm	24 mm	15 mm	15 mm	57.57.77
50 mm	24 mm	30 mm	15 mm	57.57.78
60 mm	24 mm	20 mm	15 mm	57.57.79
70 mm	24 mm	30 mm	15 mm	57.57.80

COLOUR



Tiefenlehre zur Ermittlung der korrekten Valvenlänge
 Depth gauge to identify the correct length of the blade
 Calibre de profundidad para la averiguación de la longitud correcta de las valvas
 Guide de profondeur pour la reconnaissance de la longueur de valve adaptée
 Calibro di profondità per l'identificazione della lunghezza corretta delle valve



16,5 cm – 6½" **57.57.99**



Valven besitzen eine Farbmarkierung in Form eines Punktes
 Blades are colour-marked showing a point
 Valvas son codificadas por color en forma de un punto
 Valves comportent un code couleur sous la forme d'un point
 Le valve sono dotate di un codice a colore a forma di un punto

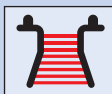

Vergrößerung des Freiraumes im Operationsfeld
 To increase the visibility of the operating area
 Aumento del espacio libre en el campo quirúrgico
 Augmentation de l'espace libre dans le champ opératoire
 Aumento dello spazio libero nel campo operatorio



Anzahl der Zähne
 Number of teeth
 Número de dientes
 Nombre de dents
 Numero dei denti



Spreizersysteme für die Wirbelsäule
Spinal Spreading Systems
Sistemas de separadores para la columna vertebral
Systèmes d'écarteurs pour la colonne vertébrale
Sistemi di divaricazione per la colonna vertebrale

B02

Spread-iT
 SPINAL SPREADING SYSTEM

Valven aus PEEK mit Fixierungs-Pin
 PEEK blades with fixation pin
 Valvas de PEEK con perno de fijación
 Valves en PEEK avec pivot de fixation
 Valve in PEEK con perno di fissazione

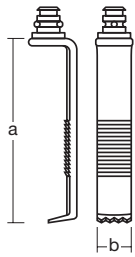

cervical / lumbal



Vollständige Röntgentransparenz
 Excellent X-ray transparency
 Completamente trasparente a los rayos X
 Complètement transparent pour les rayons X
 Completamente trasparente ai raggi X

a	b	m	
40 mm	12 mm	4	57.59.63
45 mm	12 mm	4	57.59.64
50 mm	12 mm	4	57.59.65
55 mm	12 mm	4	57.59.66
60 mm	12 mm	4	57.59.67
65 mm	12 mm	4	57.59.68
75 mm	12 mm	4	57.59.69

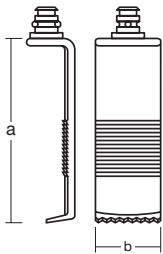

cervical / lumbal



Vollständige Röntgentransparenz
 Excellent X-ray transparency
 Completamente trasparente a los rayos X
 Complètement transparent pour les rayons X
 Completamente trasparente ai raggi X

a	b	m	
40 mm	23 mm	8	57.59.79
45 mm	23 mm	8	57.59.80
50 mm	23 mm	8	57.59.81
55 mm	23 mm	8	57.59.82
60 mm	23 mm	8	57.59.83
65 mm	23 mm	8	57.59.84
75 mm	23 mm	8	57.59.85

Pinzette für Valvenwechsel
 Forceps for changing the blades
 Pinza para cambiar las valvas
 Pince pour le changement des valves
 Pinza per cambiare le valve



11,5 cm – 4½" **57.58.87**



Spreizersysteme für die Wirbelsäule
Spinal Spreading Systems
Sistemas de separadores para la columna vertebral
Systèmes d'écarteurs pour la colonne vertébrale
Sistemi di divaricazione per la colonna vertebrale

B02

Ideal für intraoperative Bildgebungsverfahren ◀

 Ideal for intraoperative imaging ◀

 Ideal para procedimientos de imagen
 intraoperatorios ◀

 Idéal pour les procédures d'octroi d'image
 intra-opérationnelle ◀

 Ideale per immagini intraoperatorie ◀

**SPINAL SPREADING
 SYSTEMS**

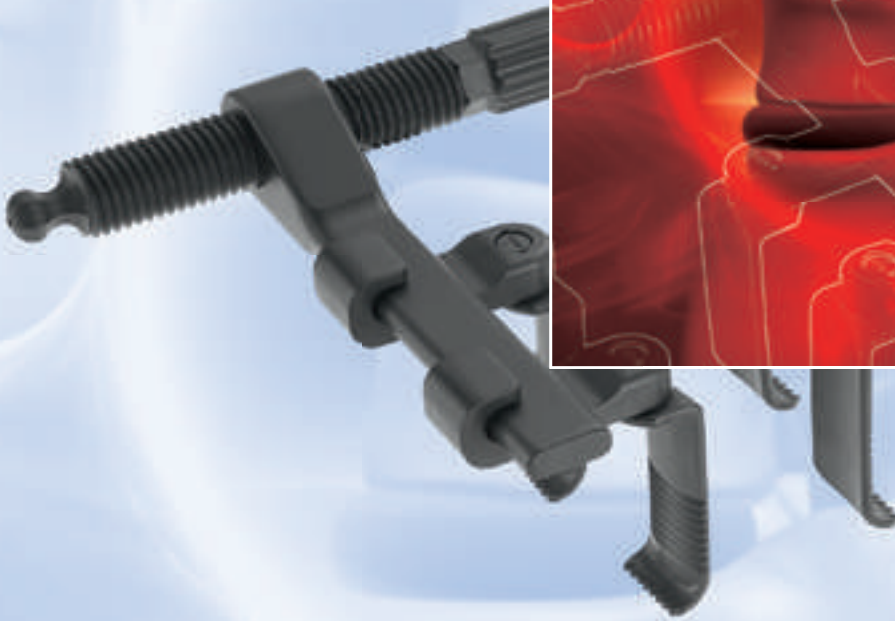
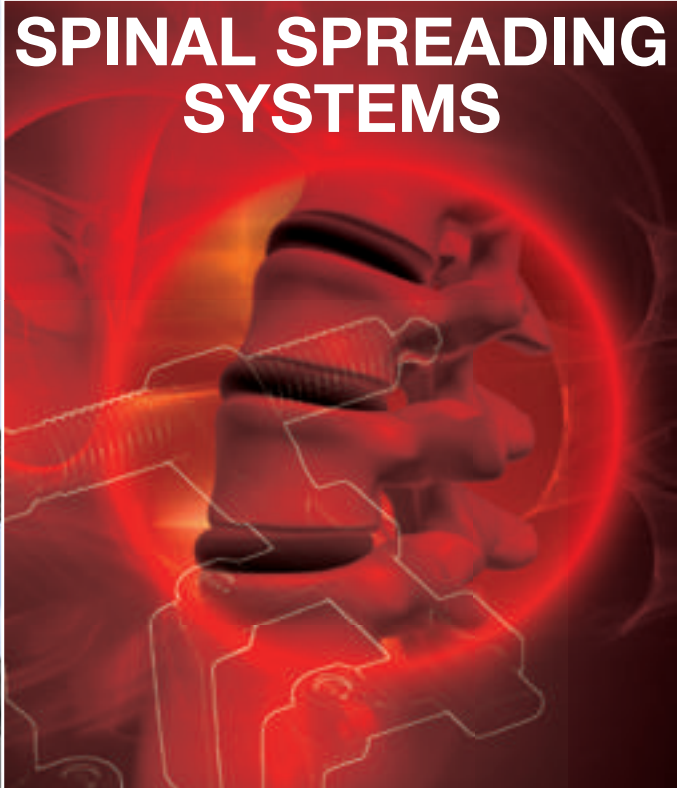

retract
 PEEK SPREADING SYSTEM

**B02**

Spreizersysteme für die Wirbelsäule
Spinal Spreading Systems
Sistemas de separadores para la columna vertebral
Systèmes d'écarteurs pour la colonne vertébrale
Sistemi di divaricazione per la colonna vertebrale



Artefaktfreie Bildgebung während der MRT/CT
Artifact-free visualisation during MRI/CT
Trasmisión de imagen libre de artefactos durante la TRM/TC
Visualisation sans artefacts pendant IRM/CT
Immagini senza artefatti durante la TAC/RMT

retract

PEEK SPREADING SYSTEM



Vollständige Röntgentransparenz
Excellent X-ray transparency
Completamente transparente a los rayos X
Complètement transparent pour les rayons X
Completamente radiotrasparente ai raggi X

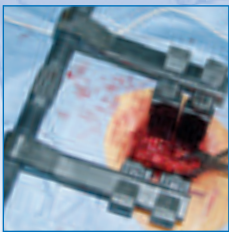

Keine intraoperative Korrektur der Sperrerposition notwendig
No intraoperative correction of the spreader position necessary
Sin corrección intraoperatoria de la posición del separador
Aucune correction intra opérationnelle de la position de l'écarteur nécessaire
Senza correzione della posizione del divaricatore

retract
PEEK SPREADING SYSTEM

Spreizersysteme für die Wirbelsäule
Spinal Spreading Systems
Sistemas de separadores para la columna vertebral
Systèmes d'écarteurs pour la colonne vertébrale
Sistemi di divaricazione per la colonna vertebrale

B02

Spreizersystem aus PEEK
PEEK spreading system
Sistema separador de PEEK
Système écarteur en PEEK
Sistema di divaricazione in PEEK

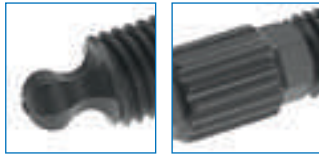

Ermöglicht eine komfortable und stufenlose Exposition
Allows a comfortable and infinitely variable exposing
Permite una exposición confortable y con progresión continua
Réglable, avec une exposition en continu pratique
Rende possibile un'esposizione comoda e continua

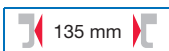
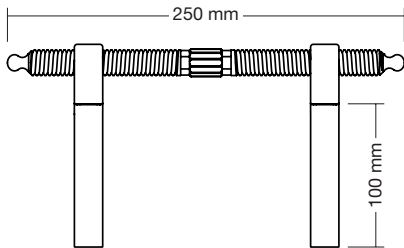
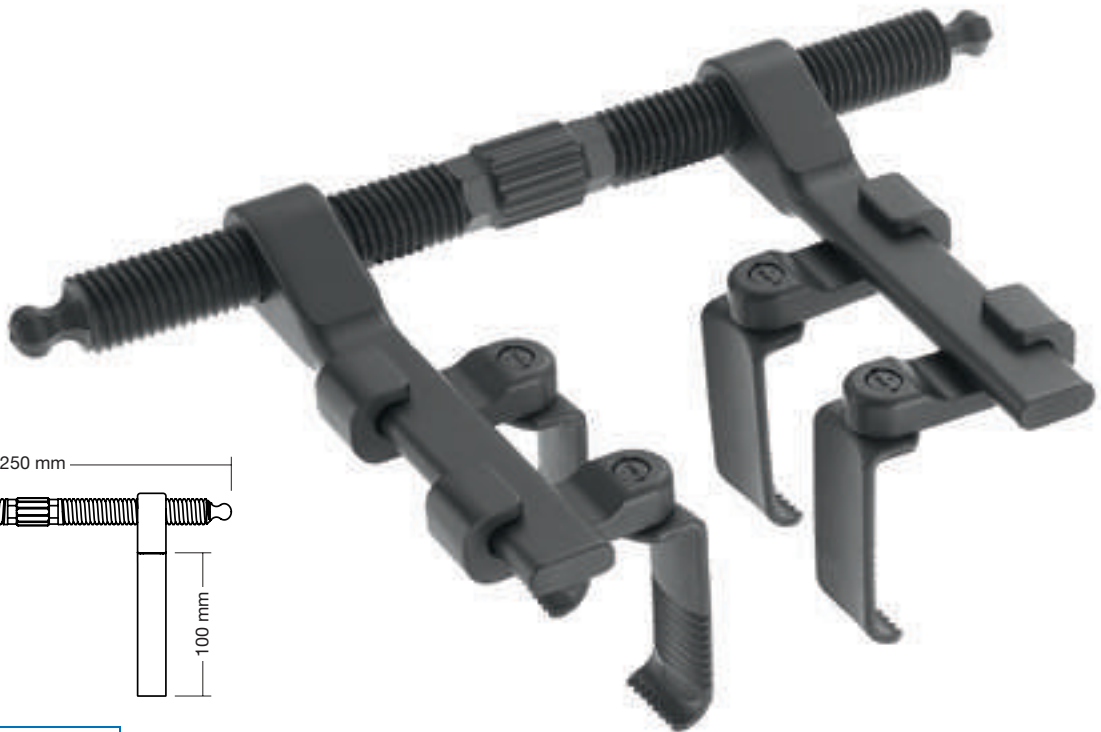

"retract"		57.62.00
	57.59.79	PEEK blades with 8 teeth (40 × 23 mm) 4x
	57.59.80	PEEK blades with 8 teeth (45 × 23 mm) 4x
	57.59.81	PEEK blades with 8 teeth (50 × 23 mm) 4x
Satz bestehend aus:	57.59.82	PEEK blades with 8 teeth (55 × 23 mm) 4x
Set consisting of:	57.59.83	PEEK blades with 8 teeth (60 × 23 mm) 4x
Juego compuesto por:	57.59.84	PEEK blades with 8 teeth (65 × 23 mm) 4x
Jeu composé de:	57.59.85	PEEK blades with 8 teeth (75 × 23 mm) 4x
Set composto da:	57.62.05	Basic unit "retract" 1x



Maximale Spreizweite zwischen den Valven
Maximum spreading width between the blades
Ancho de separación máximo entre las valvas
Ouverture maximale entre les valves
Apertura massima tra le valve



Spreizersysteme für die Wirbelsäule
Spinal Spreading Systems
Sistemas de separadores para la columna vertebral
Systèmes d'écarteurs pour la colonne vertébrale
Sistemi di divaricazione per la colonna vertebrale

B02

retract
 PEEK SPREADING SYSTEM

Grundeinheit aus PEEK
 Basic unit of PEEK
 Unidad de PEEK
 Base en PEEK
 Unità in PEEK

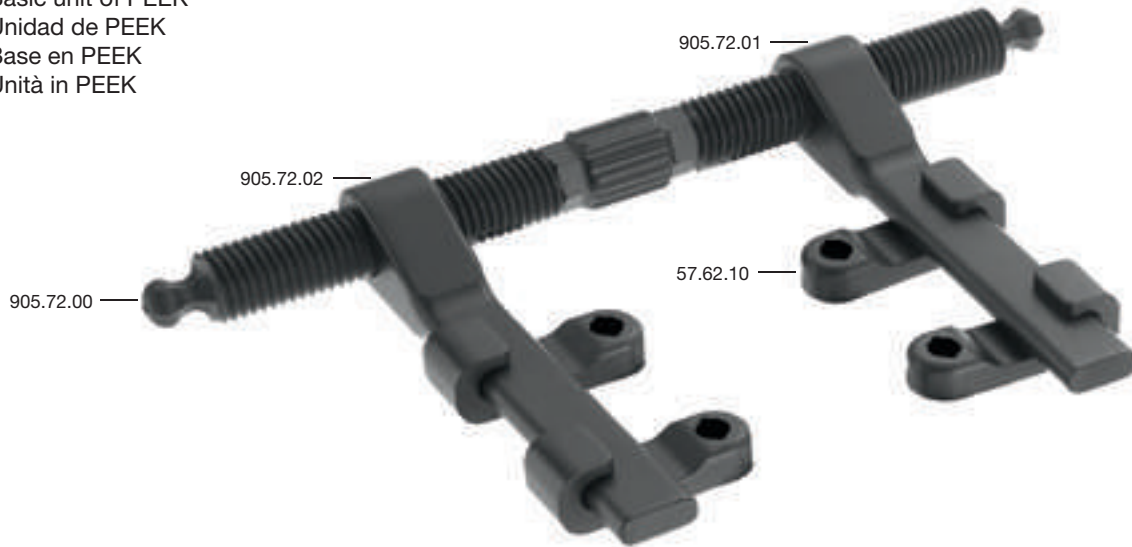

"retract"		57.62.05	
	57.62.10	Blades support	4x
Satz bestehend aus: Set consisting of:	57.62.15	Wrench (SW15)	1x
Juego compuesto por: Jeu composé de:	57.62.16	Screwdriver (SW10)	1x
Set composto da:	905.72.00	Mandrel	1x
	905.72.01	Radial arm with right hand thread	1x
	905.72.02	Radial arm with left hand thread	1x

Schlüssel
 Wrench
 Llave
 Clé
 Chiave



S 14,5 cm – 5¾" SW15 **57.62.15**

Schraubendreher
 Screwdriver
 Destornillador
 Tournevis
 Cacciavite



S 20,5 cm – 8" SW10 **57.62.16**



Valven aus PEEK mit Fixierungs-Pin
PEEK blades with fixation pin
Valvas de PEEK con perno de fijación
Valves en PEEK avec pivot de fixation
Valve in PEEK con perno di fissazione

Vollständige Röntgentransparenz
Excellent X-ray transparency
Completamente trasparente a los rayos X
Complètement transparent pour les rayons X
Completamente trasparente ai raggi X

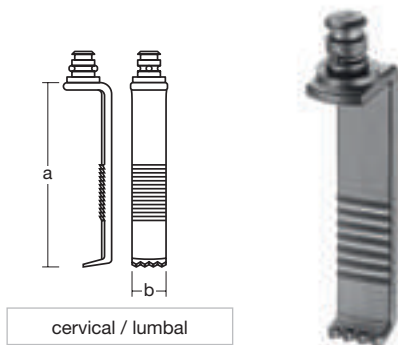

a	b		
40 mm	12 mm	4	57.59.63
45 mm	12 mm	4	57.59.64
50 mm	12 mm	4	57.59.65
55 mm	12 mm	4	57.59.66
60 mm	12 mm	4	57.59.67
65 mm	12 mm	4	57.59.68
75 mm	12 mm	4	57.59.69



Vollständige Röntgentransparenz
Excellent X-ray transparency
Completamente trasparente a los rayos X
Complètement transparent pour les rayons X
Completamente trasparente ai raggi X

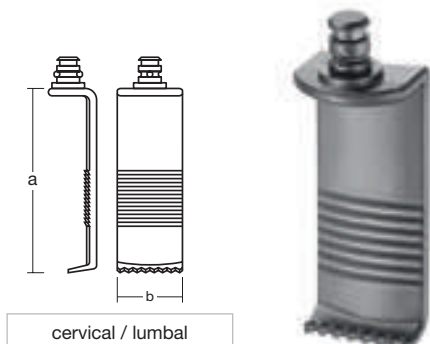

a	b		
40 mm	23 mm	8	57.59.79
45 mm	23 mm	8	57.59.80
50 mm	23 mm	8	57.59.81
55 mm	23 mm	8	57.59.82
60 mm	23 mm	8	57.59.83
65 mm	23 mm	8	57.59.84
75 mm	23 mm	8	57.59.85



Anzahl der Zähne
Number of teeth
Número de dientes
Nombre de dents
Numero dei denti



Spreizersysteme für die Wirbelsäule
Spinal Spreading Systems
Sistemas de separadores para la columna vertebral
Systèmes d'écarteurs pour la colonne vertébrale
Sistemi di divaricazione per la colonna vertebrale

B02

Spreizersystem aus Stahl mit Gelenk
 Steel spreading system with joint
 Sistema de separador de acero con articulación
 Système d'écarteur en acier avec articulation
 Sistema di divaricazione in acciaio con articolazione

57.53.01

Spreizer (allein)
 Retractor (only)
 Separador (solo)
 Ecarteur (seul)
 Divaricatore (solo)

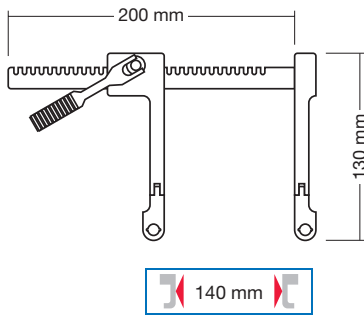
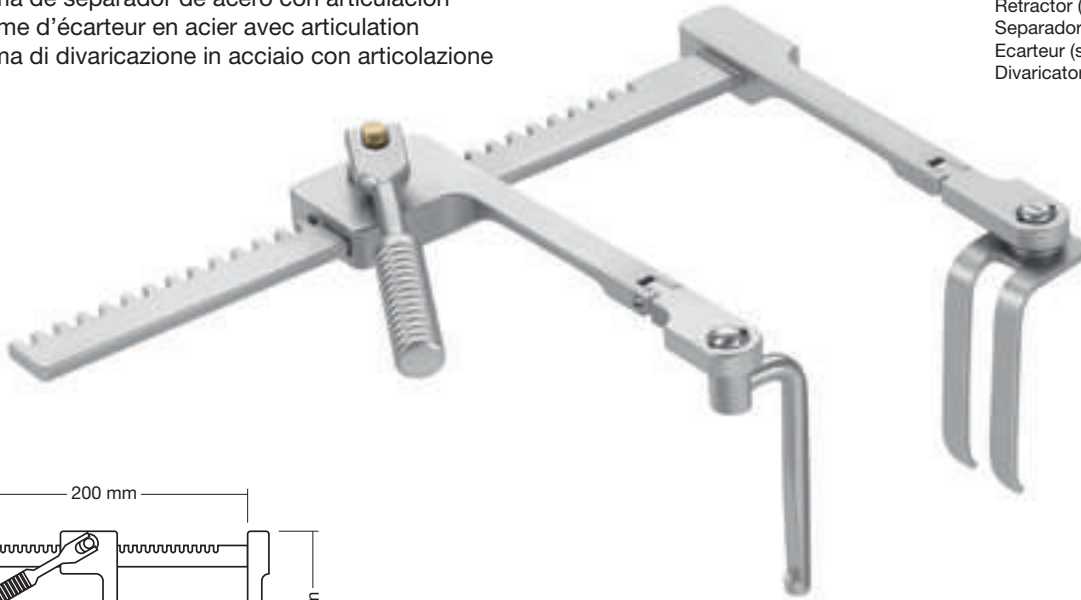

Caspar	57.53.00	
	57.53.01 Steel retractor with joint	1x
	57.53.03 Steel hook (38 mm)	1x
Satz bestehend aus: Set consisting of:	57.53.06 Steel blade with 2 teeth (37 x 22 mm)	1x
Juego compuesto por:	57.53.07 Steel blade with 2 teeth (42 x 22 mm)	1x
Jeu composé de:	57.53.08 Steel blade with 2 teeth (47 x 22 mm)	1x
Set composto da:	57.53.09 Steel blade with 2 teeth (52 x 22 mm)	1x
	57.53.10 Steel blade with 2 teeth (57 x 22 mm)	1x

Haken aus Stahl mit Fixierungs-Pin
 Steel hooks with fixation pin
 Ganchos de acero con perno de fijación
 Crochets en acier avec pivot de fixation
 Uncini in acciaio con perno di fissazione

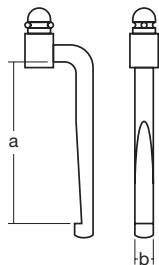

cervical / thoracal / lumbal

**Caspar**

	a	b	
	38 mm	6 mm	57.53.03
	58 mm	6 mm	57.53.04



Maximale Spreizweite zwischen den Valven
 Maximum spreading width between the blades
 Ancho de separación máximo entre las valvas
 Ouverture maximale entre les valves
 Apertura massima tra le valve

Spreizersysteme für die Wirbelsäule
Spinal Spreading Systems
Sistemas de separadores para la columna vertebral
Systèmes d'écarteurs pour la colonne vertébrale
Sistemi di divaricazione per la colonna vertebrale

B02

Valven aus Stahl
 Steel blades
 Valvas de acero
 Valves en acier
 Valve in acciaio

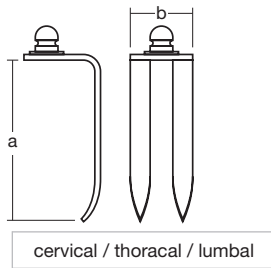

Caspar

a	b		
32 mm	22 mm	2	57.53.05
37 mm	22 mm	2	57.53.06
42 mm	22 mm	2	57.53.07
47 mm	22 mm	2	57.53.08
52 mm	22 mm	2	57.53.09
57 mm	22 mm	2	57.53.10
62 mm	22 mm	2	57.53.11
67 mm	22 mm	2	57.53.12

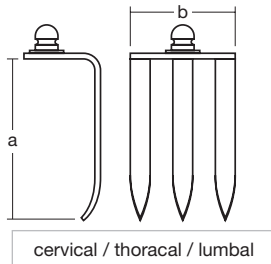

Caspar

a	b		
32 mm	37 mm	3	57.53.13
37 mm	37 mm	3	57.53.14
42 mm	37 mm	3	57.53.15
47 mm	37 mm	3	57.53.16
52 mm	37 mm	3	57.53.17
57 mm	37 mm	3	57.53.18
62 mm	37 mm	3	57.53.19
67 mm	37 mm	3	57.53.20

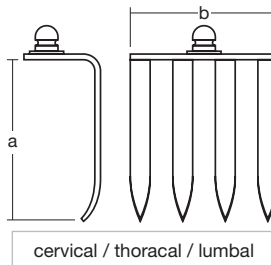

Caspar

a	b		
32 mm	52 mm	4	57.53.21
37 mm	52 mm	4	57.53.22
42 mm	52 mm	4	57.53.23
47 mm	52 mm	4	57.53.24
52 mm	52 mm	4	57.53.25
57 mm	52 mm	4	57.53.26
62 mm	52 mm	4	57.53.27
67 mm	52 mm	4	57.53.28

Pinzette für Valvenwechsel
 Forceps for changing the blades
 Pinza para cambiar las valvas
 Pince pour le changement des valves
 Pinza per cambiare le valve



11,5 cm – 4½"	57.58.87
---------------	-----------------



Anzahl der Zähne
 Number of teeth
 Número de dientes
 Nombre de dents
 Numero dei denti



Spreizersysteme für die Wirbelsäule
Spinal Spreading Systems
Sistemas de separadores para la columna vertebral
Systèmes d'écarteurs pour la colonne vertébrale
Sistemi di divaricazione per la colonna vertebrale

B02

Spreizersystem aus Stahl
 Steel spreading system
 Sistema de separador de acero
 Système d'écarteur en acier
 Sistema di divaricazione in acciaio

57.53.47

Spreizer (allein)
 Retractor (only)
 Separador (solo)
 Ecarteur (seul)
 Divaricatore (solo)

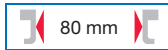
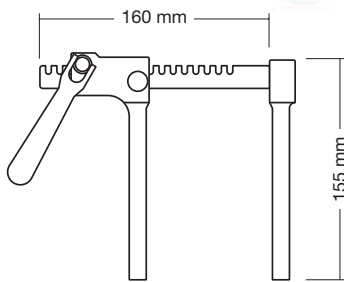
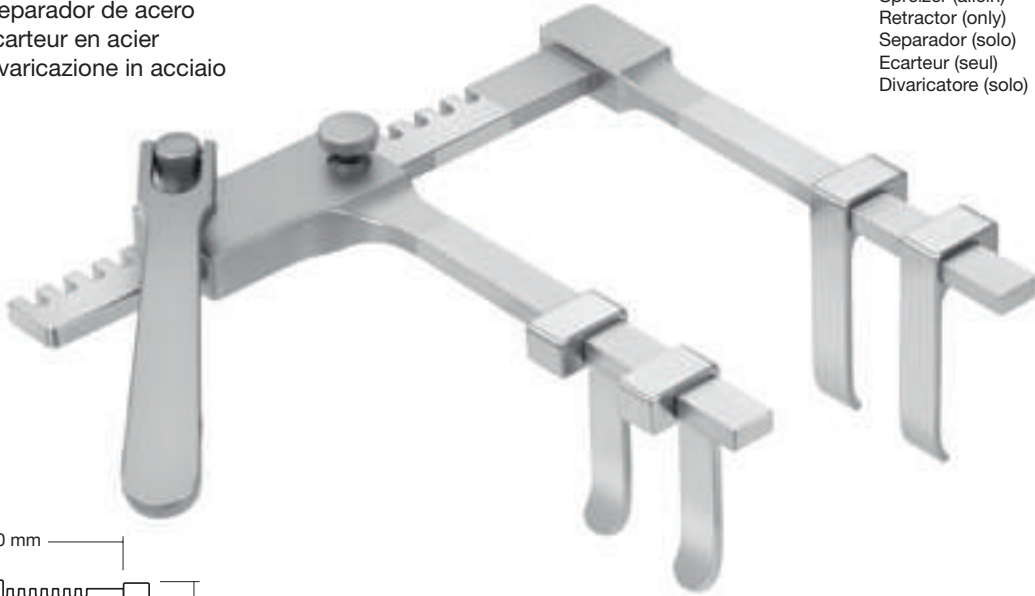
**57.53.40**

Satz bestehend aus:	57.53.41 Pairs of steel blades · left/right (40×12 mm)	1×
Set consisting of:	57.53.42 Pairs of steel blades · left/right (50×12 mm)	1×
Juego compuesto por:	57.53.43 Pairs of steel blades · left/right (65×12 mm)	1×
Jeu composé de:	57.53.47 Steel retractor	1×

Valven-Paare aus Stahl
 Pairs of steel blades
 Pares de valvas de acero
 Paires de valves en acier
 Paia di valve in acciaio

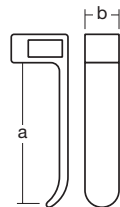

a	b	
40 mm	12 mm	57.53.41
50 mm	12 mm	57.53.42
65 mm	12 mm	57.53.43
50 mm	20 mm	57.53.45
65 mm	20 mm	57.53.46



Maximale Spreizweite zwischen den Valven
 Maximum spreading width between the blades
 Ancho de separación máximo entre las valvas
 Ouverture maximale entre les valves
 Apertura massima tra le valve

Spreizersysteme für die Wirbelsäule
Spinal Spreading Systems
Sistemas de separadores para la columna vertebral
Systèmes d'écarteurs pour la colonne vertébrale
Sistemi di divaricazione per la colonna vertebrale

B02

Spreizersystem aus Aluminium
 Aluminium spreading system
 Sistema de separador de aluminio
 Système d'écarteur en aluminium
 Sistema di divaricazione in alluminio

57.53.57

Spreizer (allein)
 Retractor (only)
 Separador (solo)
 Ecarteur (seul)
 Divaricatore (solo)

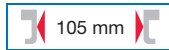
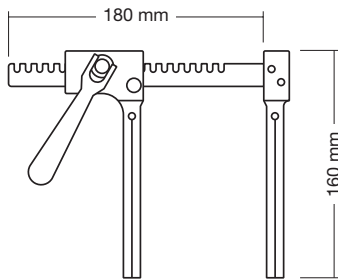
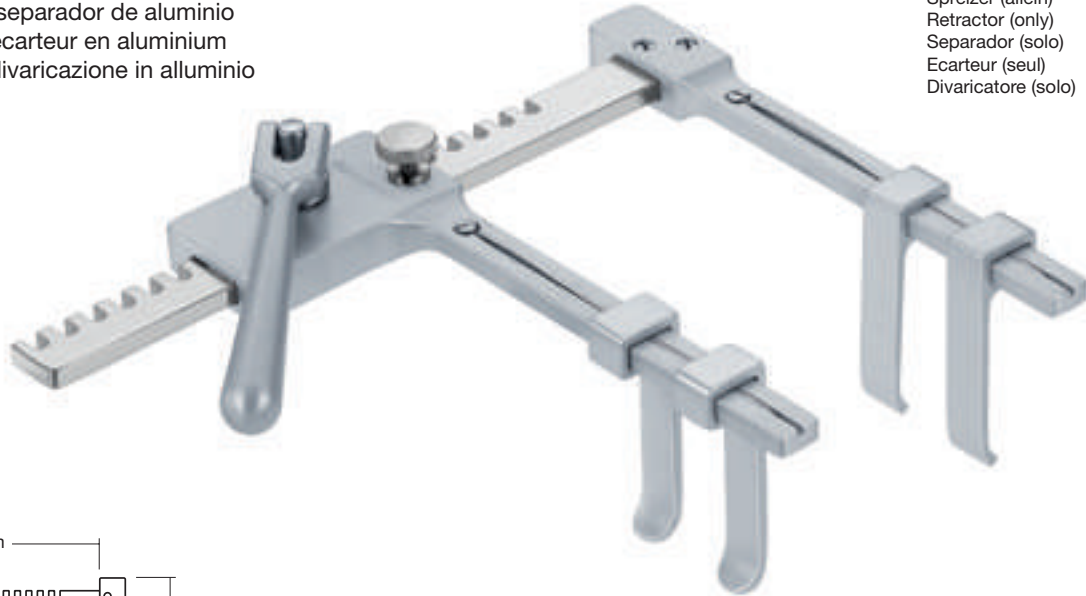

57.53.50

Satz bestehend aus:	57.53.51 Pairs of aluminium blades · left/right (40×12 mm)	1×
Set consisting of:	57.53.52 Pairs of aluminium blades · left/right (50×12 mm)	1×
Juego compuesto por:	57.53.53 Pairs of aluminium blades · left/right (65×12mm)	1×
Jeu composé de:	57.53.57 Aluminium retractor	1×

Valven-Paare aus Aluminium
 Pairs of aluminium blades
 Pares de valvas de aluminio
 Paires de valves en aluminium
 Paia di valve in alluminio

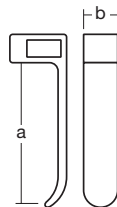

	a	b	
	40 mm	12 mm	57.53.51
	50 mm	12 mm	57.53.52
	65 mm	12 mm	57.53.53
	50 mm	20 mm	57.53.55
	65 mm	20 mm	57.53.56



Maximale Spreizweite zwischen den Valven
 Maximum spreading width between the blades
 Ancho de separación máximo entre las valvas
 Ouverture maximale entre les valves
 Apertura massima tra le valve



Spreizersysteme für die Wirbelsäule
Spinal Spreading Systems
Sistemas de separadores para la columna vertebral
Systèmes d'écarteurs pour la colonne vertébrale
Sistemi di divaricazione per la colonna vertebrale

B02

Spreizersystem aus Stahl
 Steel spreading system
 Sistema de separador de acero
 Système d'écarteur en acier
 Sistema di divaricazione in acciaio

57.53.97

Spreizer (allein)
 Retractor (only)
 Separador (solo)
 Ecarteur (seul)
 Divaricatore (solo)

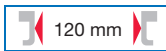
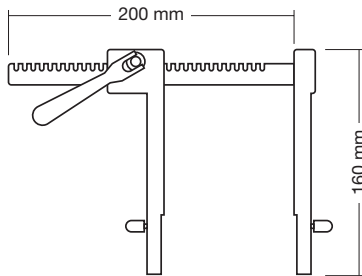
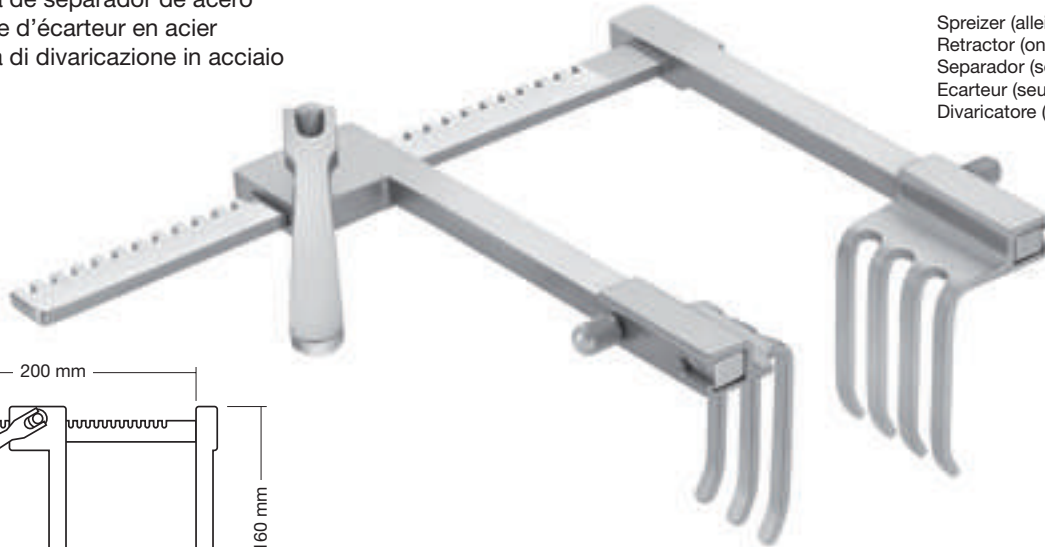
**Hauser-French****57.53.90**

	57.53.91	Steel blade with 3 teeth (38 × 32 mm)	1×
	57.53.92	Steel blade with 4 teeth (38 × 42 mm)	1×
Satz bestehend aus: Set consisting of:	57.53.93	Steel blade with 3 teeth (51 × 32 mm)	1×
Juego compuesto por: Jeu composé de:	57.53.94	Steel blade with 4 teeth (51 × 42 mm)	1×
Set composto da:	57.53.95	Steel blade with 3 teeth (66 × 32 mm)	1×
	57.53.96	Steel blade with 4 teeth (66 × 42 mm)	1×
	57.53.97	Steel retractor	1×

Valven aus Stahl
 Steel blades
 Valvas de acero
 Valves en acier
 Valve in acciaio

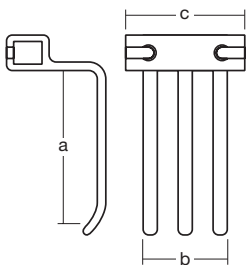

a	b	c	☞	
38 mm	32 mm	42 mm	3	57.53.91
51 mm	32 mm	42 mm	3	57.53.93
66 mm	32 mm	42 mm	3	57.53.95

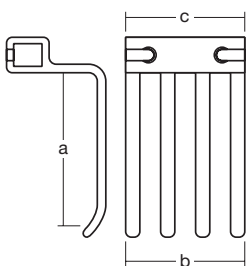

a	b	c	☞	
38 mm	42 mm	42 mm	4	57.53.92
51 mm	42 mm	42 mm	4	57.53.94
66 mm	42 mm	42 mm	4	57.53.96



Maximale Spreizweite zwischen den Valven
 Maximum spreading width between the blades
 Ancho de separación máximo entre las valvas
 Ouverture maximale entre les valves
 Apertura massima tra le valve



Anzahl der Zähne
 Number of teeth
 Número de dientes
 Nombre de dents
 Numero dei denti

Spreizersysteme für die Wirbelsäule
Spinal Spreading Systems
Sistemas de separadores para la columna vertebral
Systèmes d'écarteurs pour la colonne vertébrale
Sistemi di divaricazione per la colonna vertebrale

B02

Spreizersystem aus Stahl
 Steel spreading system
 Sistema de separador de acero
 Système d'écarteur en acier
 Sistema di divaricazione in acciaio

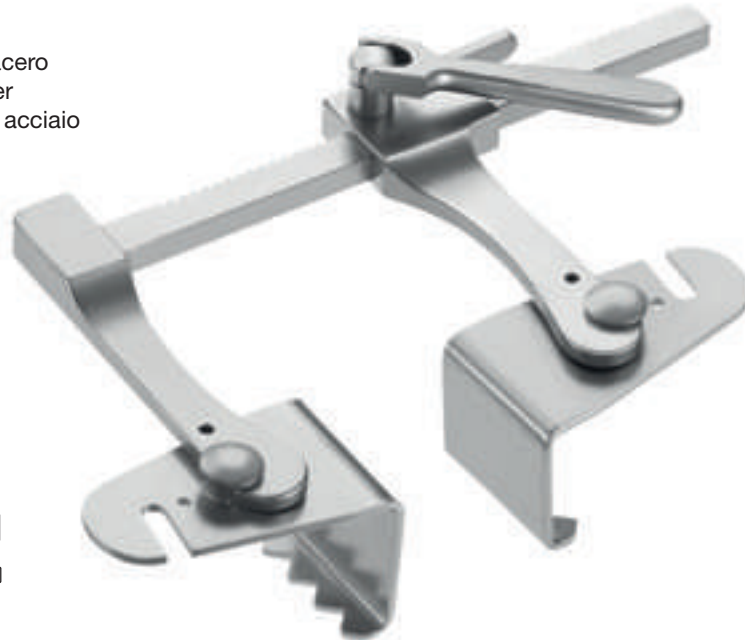

57.56.61

Spreizer (allein)
 Retractor (only)
 Separador (solo)
 Ecarteur (seul)
 Divaricatore (solo)

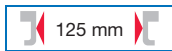
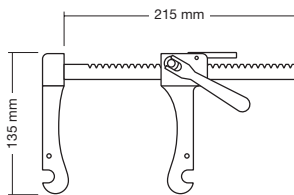

57.56.60

Satz bestehend aus:	57.56.61 Steel retractor	1x
Set consisting of:	57.56.64 Steel blades with 4 teeth (50 x 50 mm)	2x
Juego compuesto por:	57.56.65 Steel blades with 4 teeth (70 x 50 mm)	2x
Jeu composé de:	57.56.67 Blade handles	2x
Set composto da:		

Valven aus Stahl
 Steel blades
 Valvas de acero
 Valves en acier
 Valve in acciaio

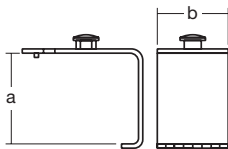

a	b		
40 mm	50 mm	4	57.56.63
50 mm	50 mm	4	57.56.64
70 mm	50 mm	4	57.56.65

Valvengriff aus Stahl
 Steel blade handle
 Mango para valva de acero
 Manche pour valves en acier
 Manico per valve in acciaio



16 cm – 6¼" **57.56.67**



Maximale Spreizweite zwischen den Valven
 Maximum spreading width between the blades
 Ancho de separación máximo entre las valvas
 Ouverture maximale entre les valves
 Apertura massima tra le valve



Anzahl der Zähne
 Number of teeth
 Número de dientes
 Nombre de dents
 Numero dei denti

**B02**

Spreizersysteme für die Wirbelsäule
Spinal Spreading Systems
Sistemas de separadores para la columna vertebral
Systèmes d'écarteurs pour la colonne vertébrale
Sistemi di divaricazione per la colonna vertebrale

Spreizersystem aus Stahl
 Steel spreading system
 Sistema de separador de acero
 Système d'écarteur en acier
 Sistema di divaricazione in acciaio

57.58.11

Spreizer (allein)
 Retractor (only)
 Separador (solo)
 Ecarteur (seul)
 Divaricatore (solo)

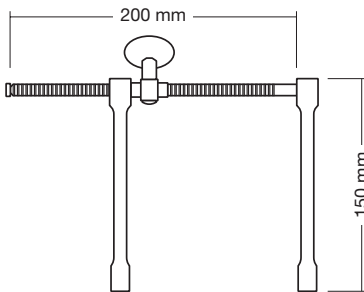

Scoville	57.58.01	
Satz bestehend aus: Set consisting of: Juego compuesto por: Jeu composé de: Set composto da:	57.58.11 Steel retractor	1x
	57.58.21 Steel hook (50 mm)	1x
	57.58.64 Steel blade with 4 teeth (25 x 60 mm)	1x



214-215



Valven (siehe Seite 214-215)
 Blades (see page 214-215)
 Valvas (véase página 214-215)
 Valves (voir page 214-215)
 Valve (vedi pagina 214-215)



Maximale Spreizweite zwischen den Valven
 Maximum spreading width between the blades
 Ancho de separación máximo entre las valvas
 Ouverture maximale entre les valves
 Apertura massima tra le valve



siehe Seite
 see page
 véase página
 voir page
 vedi pagina

Spreizersysteme für die Wirbelsäule
Spinal Spreading Systems
Sistemas de separadores para la columna vertebral
Systèmes d'écarteurs pour la colonne vertébrale
Sistemi di divaricazione per la colonna vertebrale

B02

Spreizersystem aus Stahl mit Gelenk
 Steel spreading system with joint
 Sistema de separador de acero con articulación
 Système d'écarteur en acier avec articulation
 Sistema di divaricazione in acciaio con articolazione

57.58.12

Spreizer (allein)
 Retractor (only)
 Separador (solo)
 Ecarteur (seul)
 Divaricatore (solo)

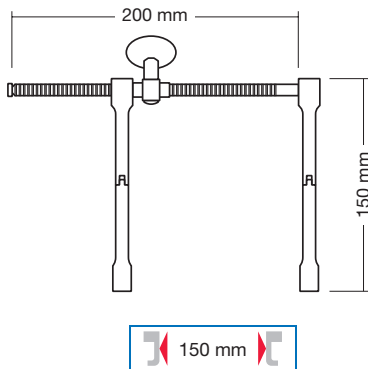

Scoville-Haverfield	57.58.02	
Satz bestehend aus: Set consisting of: Juego compuesto por: Jeu composé de: Set composto da:	57.58.12 Steel retractor with joint	1x
	57.58.21 Steel hook (50 mm)	1x
	57.58.64 Steel blade with 4 teeth (25 x 60 mm)	1x

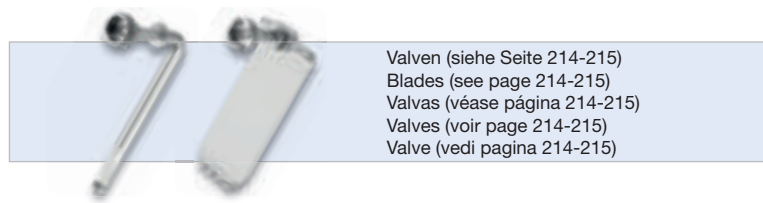

Valven (siehe Seite 214-215)
 Blades (see page 214-215)
 Valvas (véase página 214-215)
 Valves (voir page 214-215)
 Valve (vedi pagina 214-215)



Maximale Spreizweite zwischen den Valven
 Maximum spreading width between the blades
 Ancho de separación máximo entre las valvas
 Ouverture maximale entre les valves
 Apertura massima tra le valve



siehe Seite
 see page
 véase página
 voir page
 vedi pagina

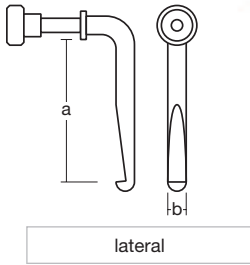

Spreizersysteme für die Wirbelsäule
Spinal Spreading Systems
Sistemas de separadores para la columna vertebral
Systèmes d'écarteurs pour la colonne vertébrale
Sistemi di divaricazione per la colonna vertebrale

B02**Scoville****Scoville**

Haken aus Stahl
 Steel hooks
 Ganchos de acero
 Crochets en acier
 Uncini in acciaio

	a	b	
①	57 mm	6 mm	57.58.21
①	83 mm	6 mm	57.58.22
②	48 mm	6 mm	57.58.31
②	78 mm	6 mm	57.58.32

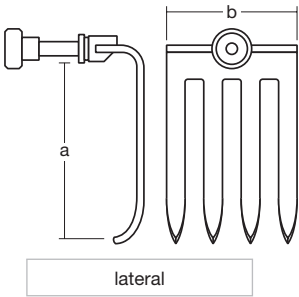
**Taylor**

Valve aus Stahl
 Steel blade
 Valva de acero
 Valve en acier
 Valva in acciaio

a	b		
44 mm	38 mm	3	57.58.51

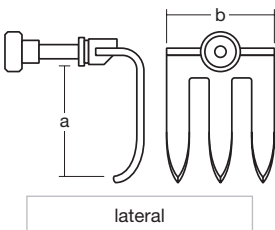
**Taylor**

Valve aus Stahl
 Steel blade
 Valva de acero
 Valve en acier
 Valva in acciaio

a	b		
70 mm	46 mm	4	57.58.52



Spreizersysteme für die Wirbelsäule
Spinal Spreading Systems
Sistemas de separadores para la columna vertebral
Systèmes d'écarteurs pour la colonne vertébrale
Sistemi di divaricazione per la colonna vertebrale

B02

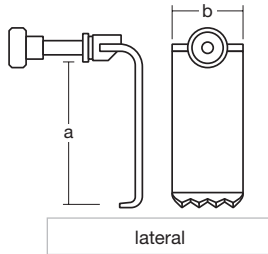

Scoville

Valven aus Stahl
 Steel blades
 Valvas de acero
 Valves en acier
 Valve in acciaio

a	b		
60 mm	25 mm	4	57.58.64
91 mm	26 mm	4	57.58.65
78 mm	29 mm	4	57.58.66
78 mm	51 mm	4	57.58.74

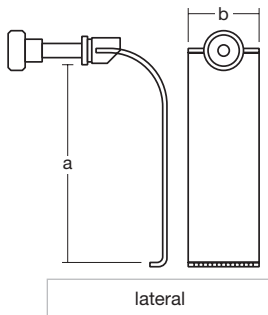

Meyerding-Scoville

Valven aus Stahl
 Steel blades
 Valvas de acero
 Valves en acier
 Valve in acciaio

a	b		
62 mm	25 mm	8	57.58.80
78 mm	25 mm	8	57.58.81
92 mm	50 mm	8	57.58.82

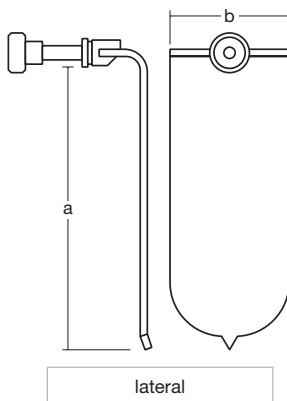

Taylor

Valven aus Stahl
 Steel blades
 Valvas de acero
 Valves en acier
 Valve in acciaio

a	b		
80 mm	31 mm	1	57.58.90
105 mm	42 mm	1	57.58.91



Anzahl der Zähne
 Number of teeth
 Número de dientes
 Nombre de dents
 Numero dei denti

**B02**

Spreizersysteme für die Wirbelsäule
Spinal Spreading Systems
Sistemas de separadores para la columna vertebral
Systèmes d'écarteurs pour la colonne vertébrale
Sistemi di divaricazione per la colonna vertebrale

Spreizersystem aus Stahl mit Gelenk
 Steel spreading system with joint
 Sistema de separador de acero con articulación
 Système d'écarteur en acier avec articulation
 Sistema di divaricazione in acciaio con articolazione

57.58.86

Spreizer (allein)
 Retractor (only)
 Separador (solo)
 Ecarteur (seul)
 Divaricatore (solo)

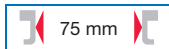
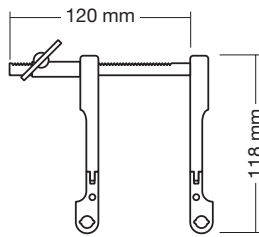
**Caspar****57.58.85**

Satz bestehend aus:
 Set consisting of:
 Juego compuesto por:
 Jeu composé de:
 Set composto da:

57.57.88	Steel blade with 5 teeth (40 × 23 mm)	1×
57.57.89	Steel blade with 5 teeth (45 × 23 mm)	1×
57.57.90	Steel blade with 5 teeth (50 × 23 mm)	1×
57.57.91	Steel blade with 5 teeth (55 × 23 mm)	1×
57.57.92	Steel blade with 5 teeth (60 × 23 mm)	1×
57.57.93	Steel blade with 7 teeth (40 × 23 mm)	1×
57.57.94	Steel blade with 7 teeth (45 × 23 mm)	1×
57.57.95	Steel blade with 7 teeth (50 × 23 mm)	1×
57.57.96	Steel blade with 7 teeth (55 × 23 mm)	1×
57.57.97	Steel blade with 7 teeth (60 × 23 mm)	1×
57.58.86	Steel retractor with joint	1×



219-221



Valven (siehe Seite 219-221)
 Blades (see page 219-221)
 Valvas (véase página 219-221)
 Valves (voir page 219-221)
 Valve (vedi pagina 219-221)



siehe Seite
 see page
 véase página
 voir page
 vedi pagina



Maximale Spreizweite zwischen den Valven
 Maximum spreading width between the blades
 Ancho de separación máximo entre las valvas
 Ouverture maximale entre les valves
 Apertura massima tra le valve



Spreizersysteme für die Wirbelsäule
Spinal Spreading Systems
Sistemas de separadores para la columna vertebral
Systèmes d'écarteurs pour la colonne vertébrale
Sistemi di divaricazione per la colonna vertebrale

B02

Spreizersystem aus Stahl mit Gelenk
 Steel spreading system with joint
 Sistema separador de acero con articulación
 Système écarteur en acier avec articulation
 Sistema di divaricazione in acciaio con articolazione

57.58.88
 Spreizer (allein)
 Retractor (only)
 Separador (solo)
 Ecarteur (seul)
 Divaricatore (solo)

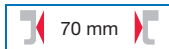
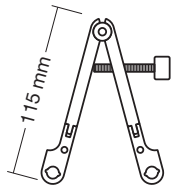
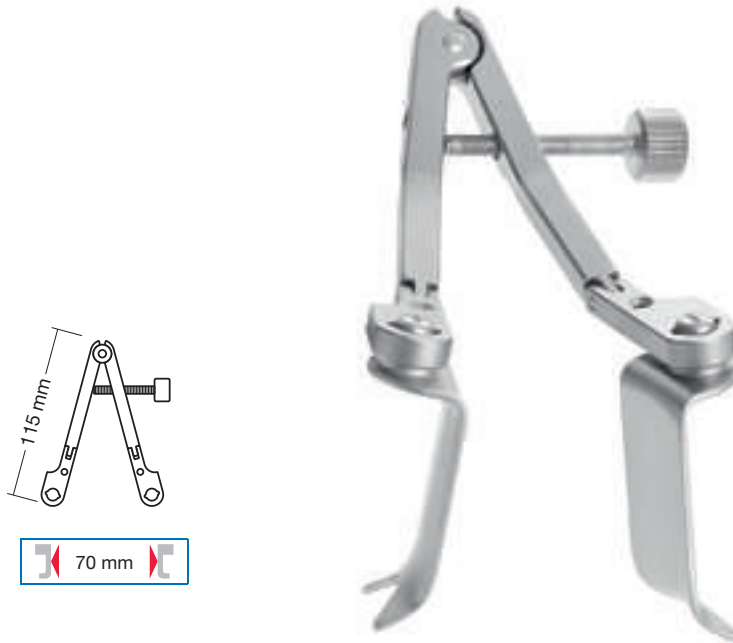

Caspar	57.58.89		
	57.58.88	Steel retractor with joint	1x
Satz bestehend aus:	57.59.51	Steel blunt blade (45 x 23 mm)	1x
Set consisting of:	57.59.52	Steel blunt blade (50 x 23 mm)	1x
Juego compuesto por:	57.59.53	Steel blunt blade (55 x 23 mm)	1x
Jeu composé de:	57.59.54	Steel blunt blade (60 x 23 mm)	1x
Set composto da:	57.59.55	Steel blunt blade (65 x 23 mm)	1x

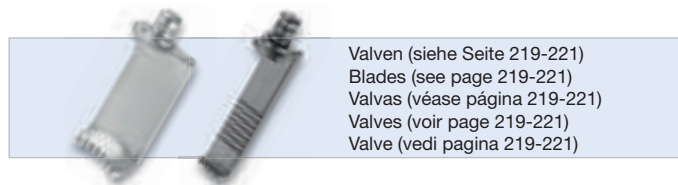

Maximale Spreizweite zwischen den Valven
 Maximum spreading width between the blades
 Ancho de separación máximo entre las valvas
 Ouverture maximale entre les valves
 Apertura massima tra le valve



siehe Seite
 see page
 véase página
 voir page
 vedi pagina

**B02**

Spreizersysteme für die Wirbelsäule
Spinal Spreading Systems
Sistemas de separadores para la columna vertebral
Systèmes d'écarteurs pour la colonne vertébrale
Sistemi di divaricazione per la colonna vertebrale

Spreizersystem aus Stahl mit Gelenk
 Steel spreading system with joint
 Sistema de separador de acero con articulación
 Système d'écarteur en acier avec articulation
 Sistema di divaricazione in acciaio con articolazione

57.58.95

Spreizer (allein)
 Retractor (only)
 Separador (solo)
 Ecarteur (seul)
 Divaricatore (solo)

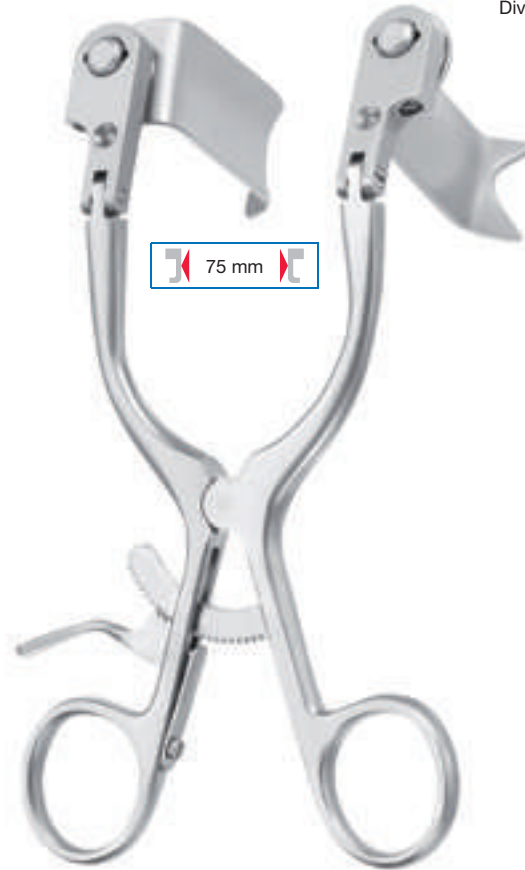
**Caspar****57.58.94**

	57.58.95 Steel retractor with joint	1x
Satz bestehend aus:	57.59.51 Steel blunt blade (45 x 23 mm)	1x
Set consisting of:	57.59.52 Steel blunt blade (50 x 23 mm)	1x
Juego compuesto por:	57.59.53 Steel blunt blade (55 x 23 mm)	1x
Jeu composé de:	57.59.54 Steel blunt blade (60 x 23 mm)	1x
Set composto da:	57.59.55 Steel blunt blade (65 x 23 mm)	1x



219-221



Valven (siehe Seite 219-221)
 Blades (see page 219-221)
 Valvas (véase página 219-221)
 Valves (voir page 219-221)
 Valve (vedi pagina 219-221)



Maximale Spreizweite zwischen den Valven
 Maximum spreading width between the blades
 Ancho de separación máximo entre las valvas
 Ouverture maximale entre les valves
 Apertura massima tra le valve



siehe Seite
 see page
 véase página
 voir page
 vedi pagina



Spreizersysteme für die Wirbelsäule
Spinal Spreading Systems
Sistemas de separadores para la columna vertebral
Systèmes d'écarteurs pour la colonne vertébrale
Sistemi di divaricazione per la colonna vertebrale

B02

Valven aus Stahl mit Fixierungs-Pin
 Steel blades with fixation pin
 Valvas de acero con perno de fijación
 Valves en acier avec pivot de fixation
 Valve in acciaio con perno di fissazione

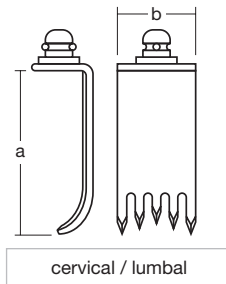

a	b		
40 mm	23 mm	5	57.57.88
45 mm	23 mm	5	57.57.89
50 mm	23 mm	5	57.57.90
55 mm	23 mm	5	57.57.91
60 mm	23 mm	5	57.57.92

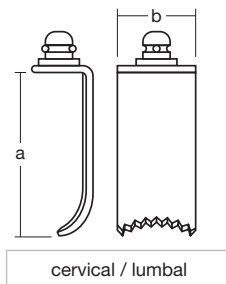

a	b		
40 mm	23 mm	7	57.57.93
45 mm	23 mm	7	57.57.94
50 mm	23 mm	7	57.57.95
55 mm	23 mm	7	57.57.96
60 mm	23 mm	7	57.57.97

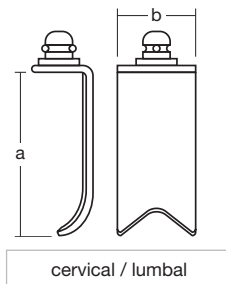

a	b	
45 mm	23 mm	57.59.51
50 mm	23 mm	57.59.52
55 mm	23 mm	57.59.53
60 mm	23 mm	57.59.54
65 mm	23 mm	57.59.55



Anzahl der Zähne
 Number of teeth
 Número de dientes
 Nombre de dents
 Numero dei denti



Spreizersysteme für die Wirbelsäule
Spinal Spreading Systems
Sistemas de separadores para la columna vertebral
Systèmes d'écarteurs pour la colonne vertébrale
Sistemi di divaricazione per la colonna vertebrale

B02

Valven aus Stahl mit Fixierungs-Pin
 Steel blades with fixation pin
 Valvas de acero con perno de fijación
 Valves en acier avec pivot de fixation
 Valve in acciaio con perno di fissazione

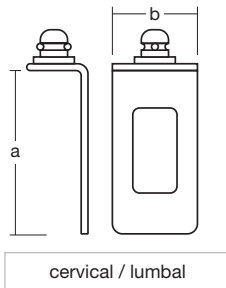

Stumpfe Valven zur Knochenentnahme aus dem Beckenkamm
 Blunt blades for bone extraction from the pelvic crest
 Valvas romas para extracción hueso de la cresta iliaca
 Valves mouses pour extraction d'os la crête iliaque
 Valve smusse per estrazione osso dalla cresta iliaca

a	b	
50 mm	25 mm	57.59.56
60 mm	25 mm	57.59.57

Valven aus Titan mit Fixierungs-Pin
 Titanium blades with fixation pin
 Valvas de titanio con perno de fijación
 Valves en titane avec pivot de fixation
 Valve in titanio con perno di fissazione

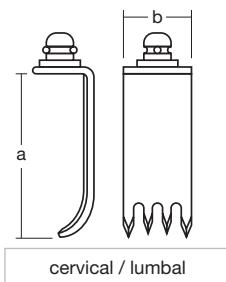
**Ti**

a	b		
40 mm	20 mm	5	57.59.58
45 mm	20 mm	5	57.59.59
50 mm	20 mm	5	57.59.60
55 mm	20 mm	5	57.59.61
60 mm	20 mm	5	57.59.62

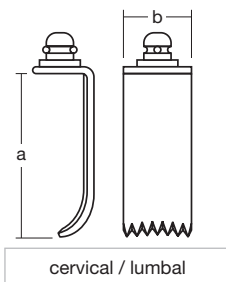
**Ti**

a	b		
40 mm	20 mm	7	57.59.93
45 mm	20 mm	7	57.59.94
50 mm	20 mm	7	57.59.95
55 mm	20 mm	7	57.59.96
60 mm	20 mm	7	57.59.97



Spreizersysteme für die Wirbelsäule
Spinal Spreading Systems
Sistemas de separadores para la columna vertebral
Systèmes d'écarteurs pour la colonne vertébrale
Sistemi di divaricazione per la colonna vertebrale

B02

Valven aus PEEK mit Fixierungs-Pin
 PEEK blades with fixation pin
 Valvas de PEEK con perno de fijación
 Valves en PEEK avec pivot de fixation
 Valve in PEEK con perno di fissazione



Vollständige Röntgentransparenz
 Excellent X-ray transparency
 Completamente trasparente a los rayos X
 Complètement transparent pour les rayons X
 Completamente trasparente ai raggi X

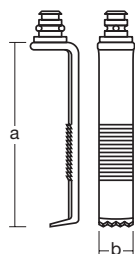

cervical / lumbal



a	b		
40 mm	12 mm	4	57.59.63
45 mm	12 mm	4	57.59.64
50 mm	12 mm	4	57.59.65
55 mm	12 mm	4	57.59.66
60 mm	12 mm	4	57.59.67
65 mm	12 mm	4	57.59.68
75 mm	12 mm	4	57.59.69

Vollständige Röntgentransparenz
 Excellent X-ray transparency
 Completamente trasparente a los rayos X
 Complètement transparent pour les rayons X
 Completamente trasparente ai raggi X

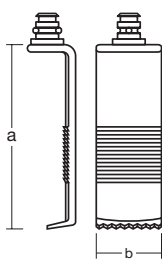

cervical / lumbal



a	b		
40 mm	23 mm	8	57.59.79
45 mm	23 mm	8	57.59.80
50 mm	23 mm	8	57.59.81
55 mm	23 mm	8	57.59.82
60 mm	23 mm	8	57.59.83
65 mm	23 mm	8	57.59.84
75 mm	23 mm	8	57.59.85

Pinzette für Valvenwechsel
 Forceps for changing the blades
 Pinza para cambiar las valvas
 Pince pour le changement des valves
 Pinza per cambiare le valve



11,5 cm – 4½" **57.58.87**



Anzahl der Zähne
 Number of teeth
 Número de dientes
 Nombre de dents
 Numero dei denti

**B02**

Spreizersysteme für die Wirbelsäule
Spinal Spreading Systems
Sistemas de separadores para la columna vertebral
Systèmes d'écarteurs pour la colonne vertébrale
Sistemi di divaricazione per la colonna vertebrale

Zervikales Spreizersystem aus Stahl
 Cervical spreading system of steel
 Sistema de separador de acero cervical
 Système d'écarteur cervical en acier
 Sistema di divaricazione in acciaio cervicale

Cloward	57.56.00	
	57.56.01	Steel retractor 1x
Satz bestehend aus:	57.56.31	Steel blunt blade (40 x 15/23 mm) 1x
Set consisting of:	57.56.32	Steel blunt blade (45 x 15/23 mm) 1x
Juego compuesto por:	57.56.33	Steel blunt blade (50 x 15/23 mm) 1x
Jeu composé de:	57.56.34	Steel blunt blade (55 x 15/23 mm) 1x
Set composto da:	57.56.35	Steel blunt blade (60 x 15/23 mm) 1x

**57.56.01**

Spreizer (allein)
 Retractor (only)
 Separador (solo)
 Ecarteur (seul)
 Divaricatore (solo)

Cloward

Spreizersystem aus Stahl mit Gelenk
 Steel spreading system with joint
 Sistema de separador de acero con articulación
 Système d'écarteur en acier avec articulation
 Sistema di divaricazione in acciaio con articolazione

Cloward	57.56.10	
	57.56.11	Steel retractor with joint 1x
Satz bestehend aus:	57.56.41	Steel blade with 4 teeth (40 x 15/23 mm) 1x
Set consisting of:	57.56.42	Steel blade with 4 teeth (45 x 15/23 mm) 1x
Juego compuesto por:	57.56.43	Steel blade with 4 teeth (50 x 15/23 mm) 1x
Jeu composé de:	57.56.44	Steel blade with 4 teeth (55 x 15/23 mm) 1x
Set composto da:	57.56.45	Steel blade with 4 teeth (60 x 15/23 mm) 1x

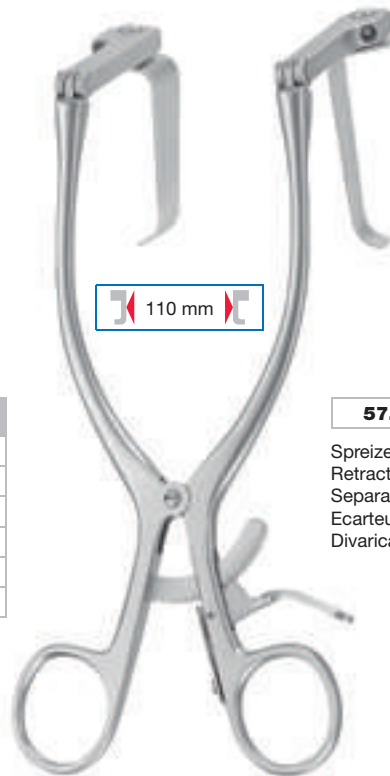
**57.56.11**

Spreizer (allein)
 Retractor (only)
 Separador (solo)
 Ecarteur (seul)
 Divaricatore (solo)

Cloward

Maximale Spreizweite zwischen den Valven
 Maximum spreading width between the blades
 Ancho de separación máximo entre las valvas
 Ouverture maximale entre les valves
 Apertura massima tra le valve

Spreizersysteme für die Wirbelsäule
Spinal Spreading Systems
Sistemas de separadores para la columna vertebral
Systèmes d'écarteurs pour la colonne vertébrale
Sistemi di divaricazione per la colonna vertebrale

B02

Valven aus Stahl
 Steel blades
 Valvas de acero
 Valves en acier
 Valve in acciaio

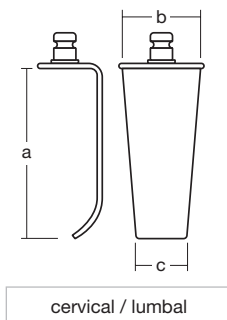

cervical / lumbal



Cloward

a	b	c	
40 mm	23 mm	15 mm	57.56.31
45 mm	23 mm	15 mm	57.56.32
50 mm	23 mm	15 mm	57.56.33
55 mm	23 mm	15 mm	57.56.34
60 mm	23 mm	15 mm	57.56.35

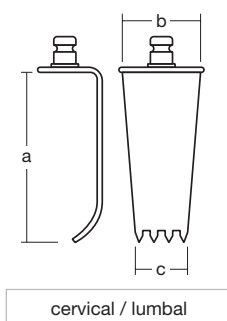

cervical / lumbal



Cloward

a	b	c		
40 mm	23 mm	15 mm	4	57.56.41
45 mm	23 mm	15 mm	4	57.56.42
50 mm	23 mm	15 mm	4	57.56.43
55 mm	23 mm	15 mm	4	57.56.44
60 mm	23 mm	15 mm	4	57.56.45



Anzahl der Zähne
 Number of teeth
 Número de dientes
 Nombre de dents
 Numero dei denti



Spreizersysteme für die Wirbelsäule
Spinal Spreading Systems
Sistemas de separadores para la columna vertebral
Systèmes d'écarteurs pour la colonne vertébrale
Sistemi di divaricazione per la colonna vertebrale

B02

SIDE-LOAD

Spreizer aus Stahl mit Doppelgelenk
 Steel retractors with double joint
 Separadores de acero con articulación doble
 Ecarteurs en acier avec articulation double
 Divaricatori in acciaio con articolazione doppia

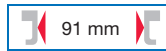
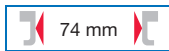
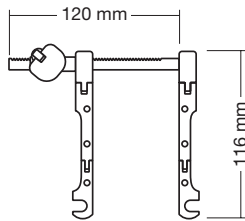

57.58.99

Side-Load

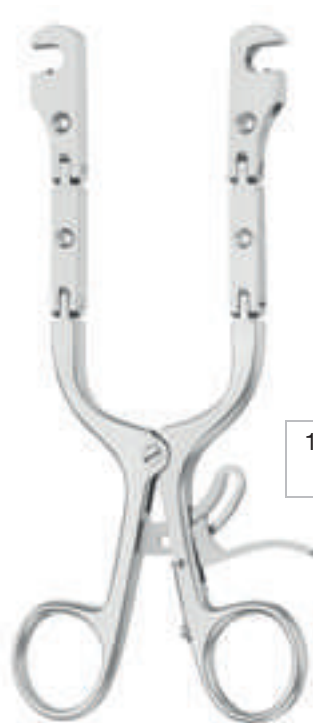

18,5 cm – 7 1/4"
57.58.98

Side-Load

Handgriff zum Einbringen von Valven
 Handle for insertion of blades
 Mango para la inserción de las valvas
 Manche pour une mise en place des valves
 Manico per l'inserimento delle valve



18 cm – 7 1/8" **57.58.97**



Kunststoffgriff (autoklavierbar bis 134 °C bei 3 bar)
 Plastic handle (autoclavable up to 134 °C at 3 bar)
 Mango de plástico (autoclavable hasta 134 °C bajo presión de 3 bar)
 Manche en plastique (autoclavable à 134 °C sous pression de 3 bars)
 Manico di plastica (autoclavabile fino a 134 °C sotto pressione di 3 bar)



Maximale Spreizweite zwischen den Valven
 Maximum spreading width between the blades
 Ancho de separación máximo entre las valvas
 Ouverture maximale entre les valves
 Apertura massima tra le valve



Titan
 Titanium
 Titano
 Titane
 Titanio



Spreizersysteme für die Wirbelsäule
Spinal Spreading Systems
Sistemas de separadores para la columna vertebral
Systèmes d'écarteurs pour la colonne vertébrale
Sistemi di divaricazione per la colonna vertebrale

B02

SIDE-LOAD

Valven aus Titan mit Farbmarkierung
 Titanium blades with colour code
 Valvas de titanio con codificación por color
 Valves en titane avec code couleur
 Valve in titanio con codice a colore

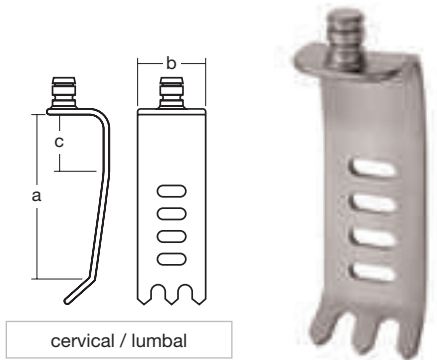

a	b	c		
30 mm	24 mm	10 mm	3	57.57.74
35 mm	24 mm	15 mm	3	57.57.75
40 mm	24 mm	15 mm	3	57.57.67
50 mm	24 mm	30 mm	3	57.57.68
60 mm	24 mm	20 mm	3	57.57.69
70 mm	24 mm	30 mm	3	57.57.70
90 mm	24 mm	50 mm	3	57.57.71
110 mm	24 mm	70 mm	3	57.57.72
130 mm	24 mm	90 mm	3	57.57.73

COLOUR

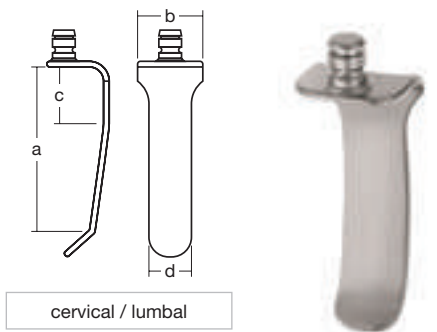

a	b	c	d	
30 mm	24 mm	10 mm	15 mm	57.57.76
40 mm	24 mm	15 mm	15 mm	57.57.77
50 mm	24 mm	30 mm	15 mm	57.57.78
60 mm	24 mm	20 mm	15 mm	57.57.79
70 mm	24 mm	30 mm	15 mm	57.57.80

COLOUR

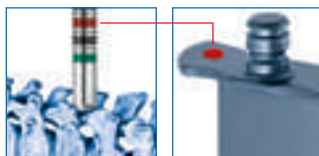

Valven besitzen eine Farbmarkierung in Form eines Punktes
 Blades are colour-marked showing a point
 Valvas son codificadas por color en forma de un punto
 Valves comportent un code couleur sous la forme d'un point
 Le valve sono dotate di un codice a colore a forma di un punto

Tiefenlehre zur Ermittlung der korrekten Valvenlänge
 Depth gauge to identify the correct length of the blade
 Calibre de profundidad para la averiguación de la longitud correcta de las valvas
 Guide de profondeur pour la reconnaissance de la longueur de valve adaptée
 Calibro di profondità per l'identificazione della lunghezza corretta delle valve



16,5 cm – 6½" **57.57.99**



Anzahl der Zähne
 Number of teeth
 Número de dientes
 Nombre de dents
 Numero dei denti

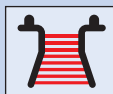

Vergrößerung des Freiraumes im Operationsfeld
 To increase the visibility of the operating area
 Aumento del espacio libre en el campo quirúrgico
 Augmentation de l'espace libre dans le champ opératoire
 Aumento dello spazio libero nel campo operatorio



Spreizersysteme für die Wirbelsäule
Spinal Spreading Systems
Sistemas de separadores para la columna vertebral
Systèmes d'écarteurs pour la colonne vertébrale
Sistemi di divaricazione per la colonna vertebrale

B02

Gegensperrer
 Counter retractor
 Contra-separador
 Contre-écarteur
 Contro-divaricatore

**57.57.51**

Gegensperrer (allein)
 Counter retractor (only)
 Contra-separador (solo)
 Contre-écarteur (seul)
 Contro-divaricatore (solo)

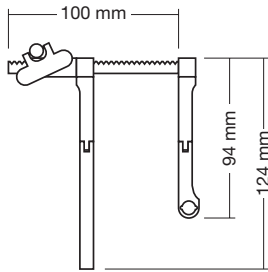

Caspar	57.57.50	
	57.57.51 Counter retractor	1x
	57.57.53 Blade (35 mm)	1x
Satz bestehend aus: Set consisting of: Juego compuesto por: Jeu composé de: Set composto da:	57.57.54 Blade (40 mm)	1x
	57.57.55 Blade (45 mm)	1x
	57.57.56 Blade (50 mm)	1x
	57.57.57 Blade (55 mm)	1x
	57.57.58 Blade (60 mm)	1x

Spekula für Gegensperrer
 Specula for counter-retractor
 Espéculos para contra-separador
 Spéculums pour contre-écarteur
 Specoli per contro-divaricatore

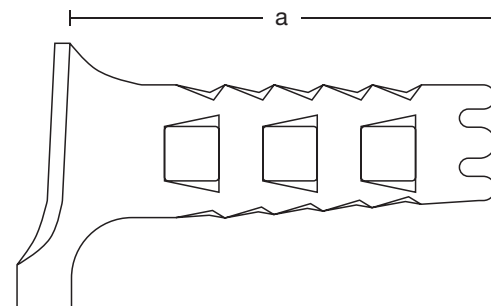
**Caspar**

a	
40 mm	57.57.40
45 mm	57.57.41
50 mm	57.57.42
55 mm	57.57.43
60 mm	57.57.44
65 mm	57.57.45
75 mm	57.57.46
85 mm	57.57.47





Maximale Spreizweite zwischen den Valven
 Maximum spreading width between the blades
 Ancho de separación máximo entre las valvas
 Ouverture maximale entre les valves
 Apertura massima tra le valve

Spreizersysteme für die Wirbelsäule
Spinal Spreading Systems
Sistemas de separadores para la columna vertebral
Systèmes d'écarteurs pour la colonne vertébrale
Sistemi di divaricazione per la colonna vertebrale

B02

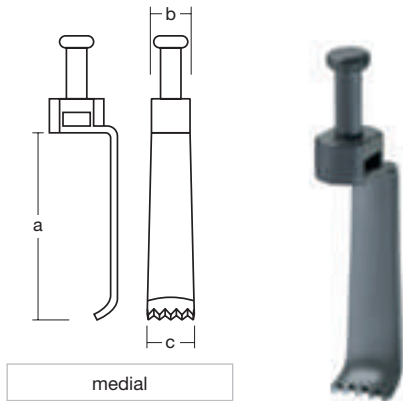
Valven aus Stahl
 Steel blades
 Valvas de acero
 Valves en acier
 Valve in acciaio



a	b	c		
35 mm	12 mm	15 mm	5	57.57.33
40 mm	12 mm	15 mm	5	57.57.34
45 mm	12 mm	15 mm	5	57.57.35
50 mm	12 mm	15 mm	5	57.57.36
55 mm	12 mm	15 mm	5	57.57.37
60 mm	12 mm	15 mm	5	57.57.38
65 mm	12 mm	15 mm	5	57.57.39

Valven aus Stahl mit Fixierungs-Pin
 Steel blades with fixation pin
 Valvas de acero con perno de fijación
 Valves en acier avec pivot de fixation
 Valve in acciaio con perno di fissazione

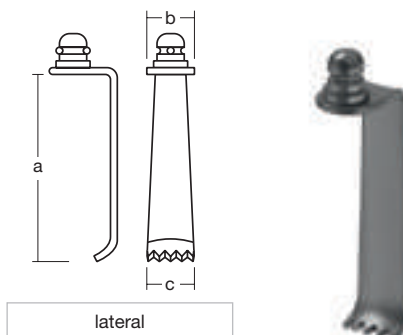

a	b	c		
35 mm	9 mm	14 mm	5	57.57.53
40 mm	9 mm	14 mm	5	57.57.54
45 mm	9 mm	14 mm	5	57.57.55
50 mm	9 mm	14 mm	5	57.57.56
55 mm	9 mm	14 mm	5	57.57.57
60 mm	9 mm	14 mm	5	57.57.58
65 mm	9 mm	14 mm	5	57.57.59
75 mm	9 mm	14 mm	5	57.57.60
85 mm	9 mm	14 mm	5	57.57.61



Anzahl der Zähne
 Number of teeth
 Número de dientes
 Nombre de dents
 Numero dei denti



Spreizersysteme für die Wirbelsäule
Spinal Spreading Systems
Sistemas de separadores para la columna vertebral
Systèmes d'écarteurs pour la colonne vertébrale
Sistemi di divaricazione per la colonna vertebrale

B02



Zervikal-Gewebespreizer
 Cervical tissue retractor
 Separador para tejido cervical
 Ecarteur de tissu cervical
 Divaricatore per tessuto cervicale

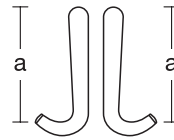

a = 13 mm
 13 cm – 5 1/8" **57.55.50**



Laminaspreizer
 Lamina retractors
 Separadores laminar
 Ecarteurs lamina
 Divaricatori vertebrale



Cloward

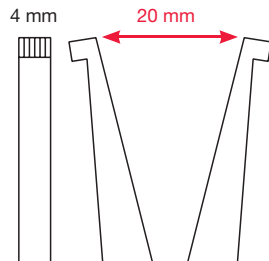

16 cm – 6 1/4" **57.55.75**



Cloward

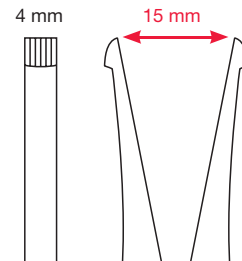

13 cm – 5 1/8" **57.55.80**



stumpf
 blunt
 roma
 mousse
 smussa

Spreizersysteme für die Wirbelsäule
Spinal Spreading Systems
Sistemas de separadores para la columna vertebral
Systèmes d'écarteurs pour la colonne vertébrale
Sistemi di divaricazione per la colonna vertebrale

B02

Laminaspreizer
 Lamina retractors
 Separadores laminar
 Ecarteurs lamina
 Divaricatori vertebrale

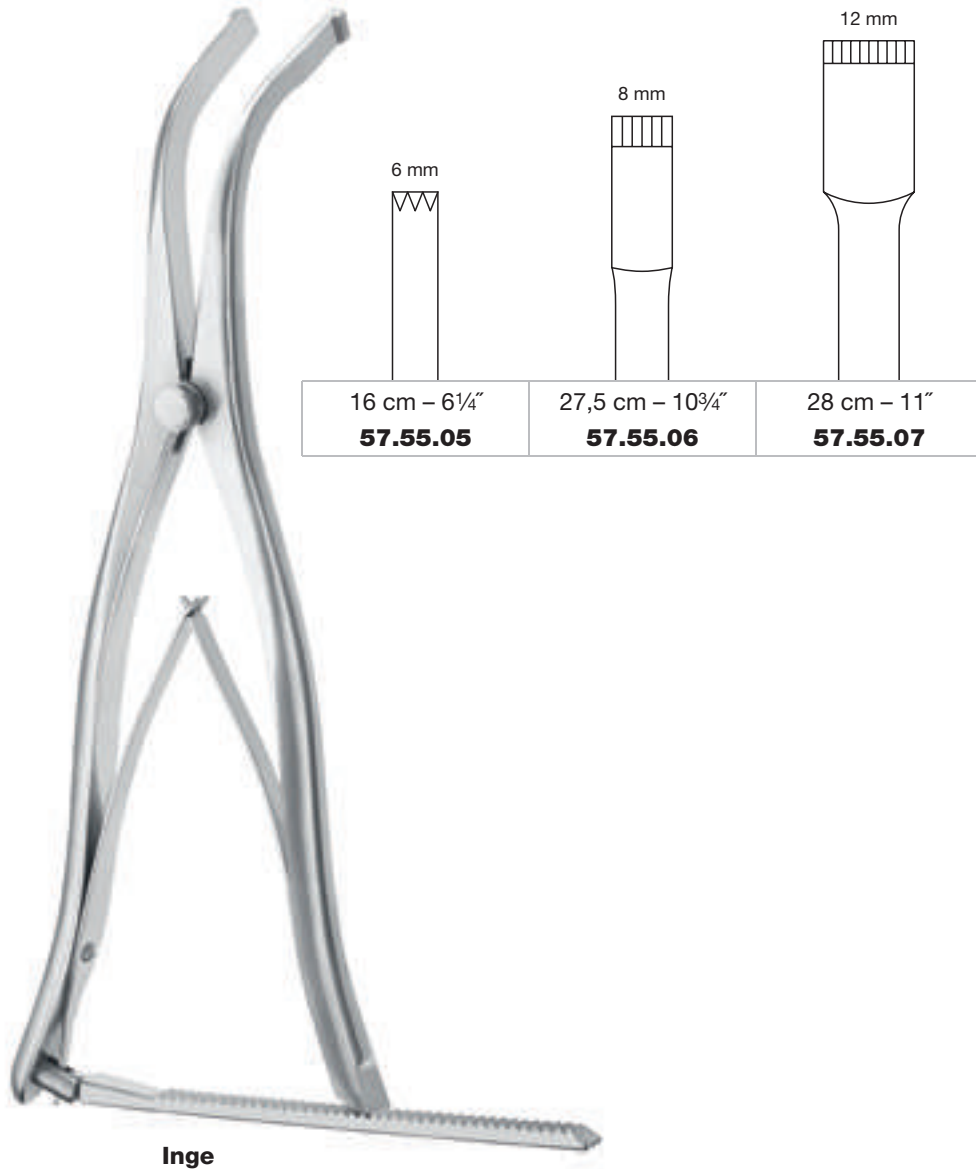



Spreizersysteme für die Wirbelsäule
Spinal Spreading Systems
Sistemas de separadores para la columna vertebral
Systèmes d'écarteurs pour la colonne vertébrale
Sistemi di divaricazione per la colonna vertebrale

B02



Markham-Meyerding

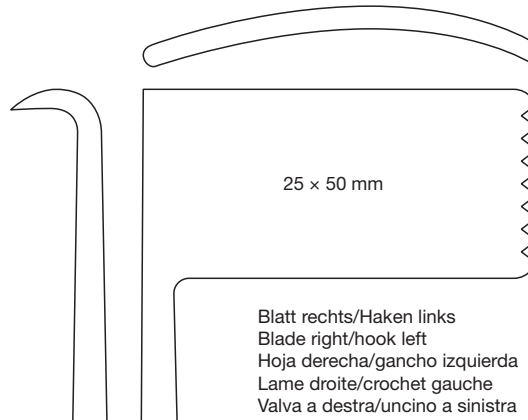

18 cm - 7 1/8"
24.45.90



Markham-Meyerding

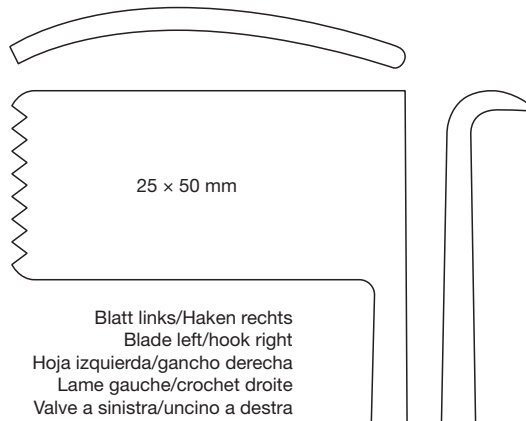

18 cm - 7 1/8"
24.45.91

Spreizersysteme für die Wirbelsäule
Spinal Spreading Systems
Sistemas de separadores para la columna vertebral
Systèmes d'écarteurs pour la colonne vertébrale
Sistemi di divaricazione per la colonna vertebrale

B02

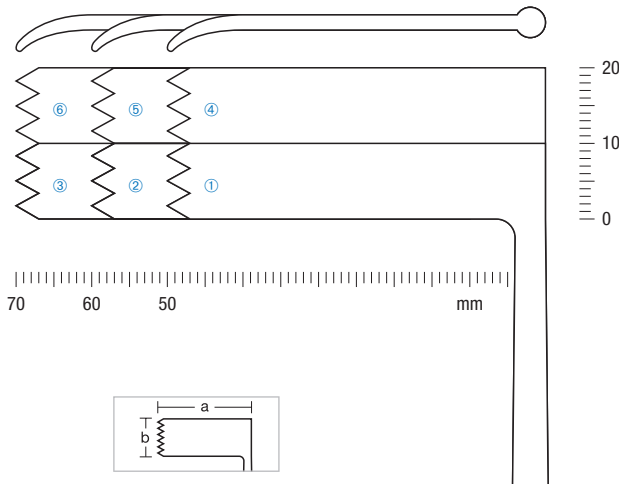

①	a = 50 mm	b = 10 mm	17 cm - 6¾"	57.55.30
②	a = 60 mm	b = 10 mm	17 cm - 6¾"	57.55.32
③	a = 70 mm	b = 10 mm	17 cm - 6¾"	57.55.34
④	a = 50 mm	b = 20 mm	17 cm - 6¾"	57.55.36
⑤	a = 60 mm	b = 20 mm	17 cm - 6¾"	57.55.38
⑥	a = 70 mm	b = 20 mm	17 cm - 6¾"	57.55.40



Blatt links/Haken rechts
 Blade left/hook right
 Hoja izquierda/gancho derecha
 Lame gauche/crochet droite
 Valva a sinistra/uncino a destra

Williams

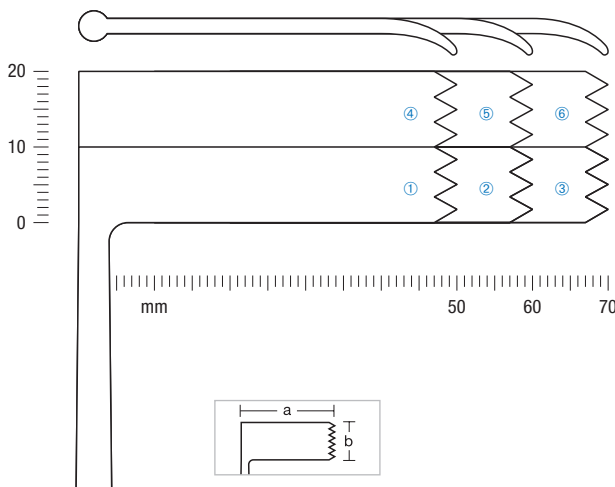

①	a = 50 mm	b = 10 mm	17 cm - 6¾"	57.55.31
②	a = 60 mm	b = 10 mm	17 cm - 6¾"	57.55.33
③	a = 70 mm	b = 10 mm	17 cm - 6¾"	57.55.35
④	a = 50 mm	b = 20 mm	17 cm - 6¾"	57.55.37
⑤	a = 60 mm	b = 20 mm	17 cm - 6¾"	57.55.39
⑥	a = 70 mm	b = 20 mm	17 cm - 6¾"	57.55.41



Valve rechts/Haken links
 Blade right/hook left
 Hoja derecha/gancho izquierda
 Lame droite/crochet gauche
 Valva a destra/uncino a sinistra

Williams

mediExpand

VERTEBRAL BODY REPLACEMENT

Cervical

Wirbelkörperersatz für die zervikale Wirbelsäule

Vertebral body replacement for cervical spine

Sustitución de cuerpo vertebral para la columna vertebral cervical

Le remplacement du corps vertébral pour la colonne vertébrale cervicale

Sostituto del corpo vertebrale per la colonna vertebrale cervicale

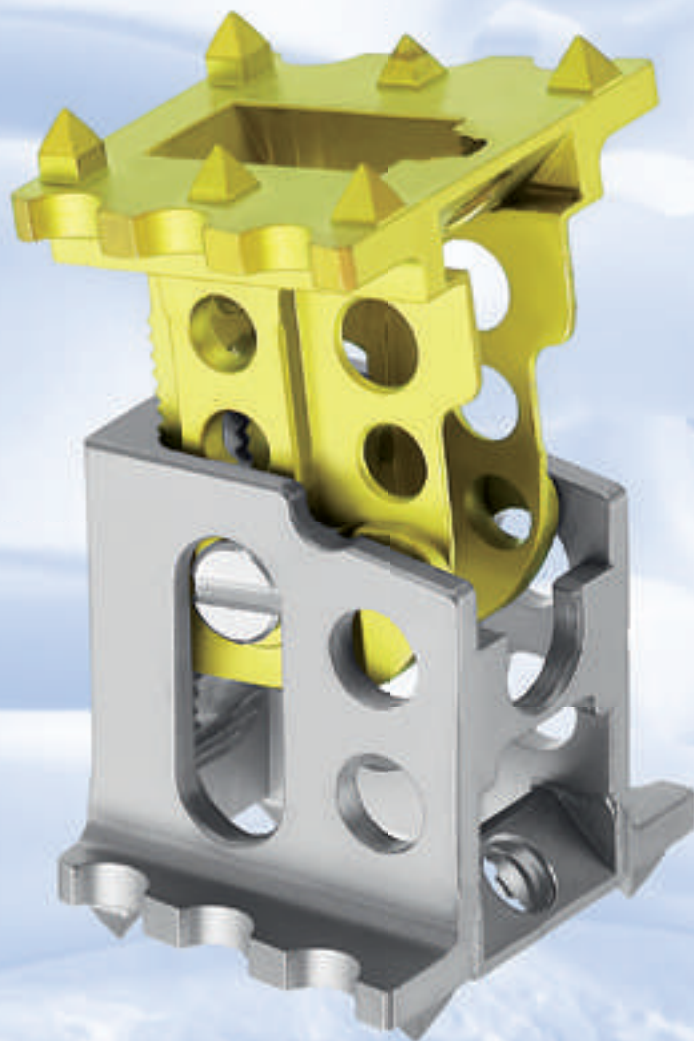

Zervikales Wirbelkörper-Distraktionssystem
Cervical Vertebral Body Distraction System
Sistema de distractor para el cuerpo vertebral cervical
Système distracteur pour les vertèbres cervicales
Sistema distrattore per il corpo vertebrale cervicale

B03

Distractionssystem für linksseitigen Zugang
 Distraction system for left side access
 Sistema de distractor para el acceso de izquierda
 Système distracteur pour l'accès de gauche
 Sistema distrattore per l'accesso di sinistra



57.55.10		
Satz bestehend aus:	57.55.11 Drilling sleeve	1x
Set consisting of:	57.55.14 Vertebral distraction device	1x
Juego compuesto por:	57.55.18 Twist drill for rough drilling	1x
Jeu composé de:	57.55.19 Screwdriver	1x
Set composto da:	57.55.22 Distraction screws (16 mm)	2x



Kunststoffgriff (autoklavierbar bis 134 °C bei 3 bar)
 Plastic handle (autoclavable up to 134 °C at 3 bar)
 Mango de plástico (autoclavable hasta 134 °C bajo presión de 3 bar)
 Manche en plastique (autoclavable à 134 °C sous pression de 3 bars)
 Manico di plastica (autoclavabile fino a 134 °C sotto pressione di 3 bar)

**B03**

Zervikales Wirbelkörper-Distraktionssystem
Cervical Vertebral Body Distraction System
Sistema de distractor para el cuerpo vertebral cervical
Système distracteur pour les vertèbres cervicales
Sistema distrattore per il corpo vertebrale cervicale

Distraktionssystem für rechtsseitigen Zugang
 Distraction system for right side access
 Sistema de distractor para el acceso de derecha
 Système distracteur pour l'accès de droite
 Sistema distrattore per l'accesso da destra

**57.55.12**

Satz bestehend aus:	57.55.13 Drilling sleeve	1x
Set consisting of:	57.55.15 Vertebral distraction device	1x
Juego compuesto por:	57.55.18 Twist drill for rough drilling	1x
Jeu composé de:	57.55.19 Screwdriver	1x
Set composto da:	57.55.22 Distraction screws (16 mm)	2x



Kunststoffgriff (autoklavierbar bis 134 °C bei 3 bar)
 Plastic handle (autoclavable up to 134 °C at 3 bar)
 Mango de plástico (autoclavable hasta 134 °C bajo presión de 3 bar)
 Manche en plastique (autoclavable à 134 °C sous pression de 3 bars)
 Manico di plastica (autoclavabile fino a 134 °C sotto pressione di 3 bar)



Zervikales Wirbelkörper-Distraktionssystem
Cervical Vertebral Body Distraction System
Sistema de distractor para el cuerpo vertebral cervical
Système distracteur pour les vertèbres cervicales
Sistema distrattore per il corpo vertebrale cervicale

B03

Bohrhülsen
 Drilling sleeves
 Casquillos portabrocas
 Douilles de forage
 Bussole di foratura



(L)

21,5 cm – 8½"
57.55.11



(R)

21,5 cm – 8½"
57.55.13

Wirbelkörperdistraktoren
 Vertebral distraction devices
 Distractores vertebrales
 Distracteurs vertébraux
 Distrattori vertebrali

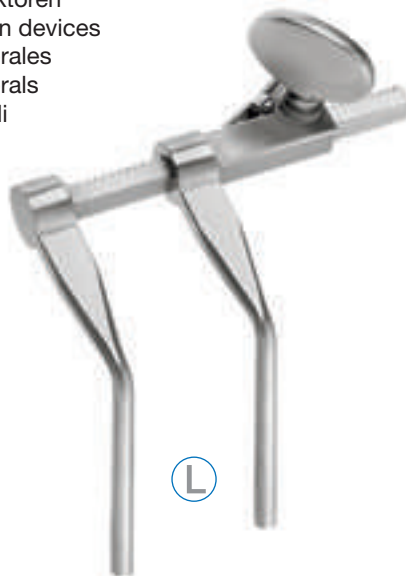

(L)

57.55.14



(R)

57.55.15



für linksseitigen Zugang
 for left side access
 para el acceso de izquierda
 pour l'accès de gauche
 per l'accesso da sinistra

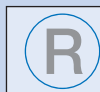

für rechtsseitigen Zugang
 for right side access
 para el acceso de derecha
 pour l'accès de droite
 per l'accesso da destra

**B03**

Zervikales Wirbelkörper-Distraktionssystem
Cervical Vertebral Body Distraction System
Sistema de distractor para el cuerpo vertebral cervical
Système distracteur pour les vertèbres cervicales
Sistema distrattore per il corpo vertebrale cervicale



Spiralbohrer
 Twist drill
 Broca espiral
 Foret hélicoïdal
 Perforatore elicoidale



a = 13 mm **57.55.18** 14,5 cm – 5¾"

Schraubendreher
 Screwdriver
 Destornillador
 Tournevis
 Cacciavite



57.55.19 20 cm – 8"

Distraktionsschrauben
 Distraction screws
 Tornillos de distracción
 Vis à distraction
 Viti di distrazione

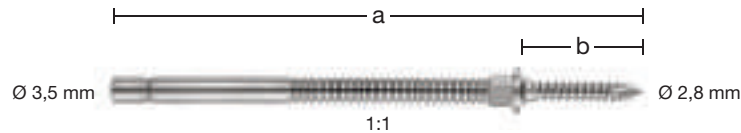

a = 66 mm **57.55.20** b = 12 mm

a = 68 mm **57.55.21** b = 14 mm

a = 70 mm **57.55.22** b = 16 mm

a = 72 mm **57.55.23** b = 18 mm

Aufnahme für Distraktionsschrauben
 Adapter for distraction screws
 Soporte para tornillos de distracción
 Support pour vis à distraction
 Supporto per viti di distrazione



für Zervikalspreizer:
 for cervical retractors:
 para separador cervical:
 pour écarteur cervical:
 per divaricatore cervicale:

CASPAR / CERVICALINO



Ø 8 mm 10 cm – 4" **57.55.24**



Kunststoffgriff (autoklavierbar bis 134 °C bei 3 bar)
 Plastic handle (autoclavable up to 134 °C at 3 bar)
 Mango de plástico (autoclavable hasta 134 °C bajo presión de 3 bar)
 Manche en plastique (autoclavable à 134 °C sous pression de 3 bars)
 Manico di plastica (autoclavabile fino a 134 °C sotto pressione di 3 bar)

Stanzen und Rongeur
Rongeurs
Pinzas saca-bocadas y pinzas cortantes
Pinces emporte-pièce et rongeurs
Laminotomi e pinze per laminectomia

B04

- Flacher Schieber ◀
- Ergonomisches Design und Balance ◀
- Einteilige Zerlegetechnik ◀

- Flat upper slide ◀
- Ergonomic design and balance ◀
- One piece dismantable rongeur ◀

- Corredera plana posibilita ◀
- Diseño ergonómico e equilibrado ◀
- Pinza saca-bocada desmontable de una sola pieza ◀

- Coulisse plate ◀
- Design et équilibre ergonomiques ◀
- Technique de démontage en une pièce ◀

- Asta piatta ◀
- Design ed equilibrio ergonomici ◀
- Tecnica di smontaggio monopezzo ◀



Kerrison
 ...DieBLAUEN.



B04

Kerrison ...DieBLAUEN.

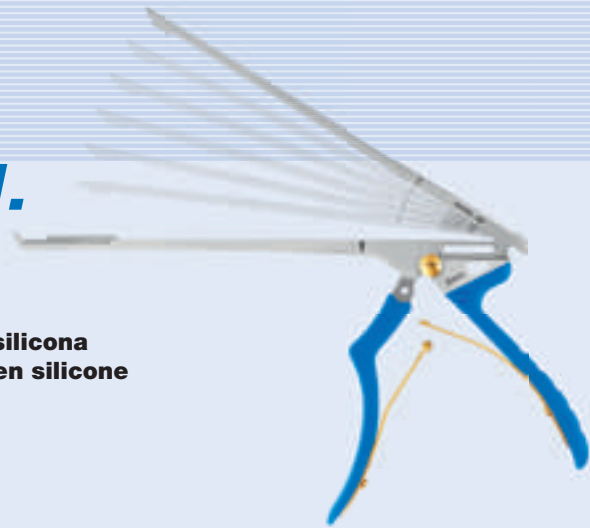

Zerlegbare Stanzen mit Silikongriff
Dismantable rongeurs with silicone handle
Pinzas saca-bocadas desmontable con mango de silicona
Pinces emporte-pièce démontables avec manche en silicone
Laminotomi smontabili con manico in silicone

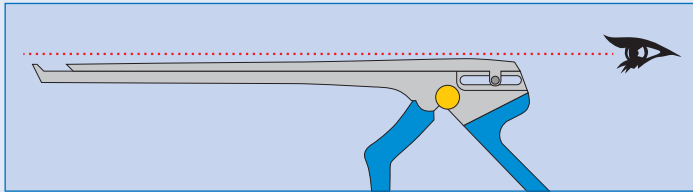

Flacher Schieber für optimale Sicht bei minimal-invasiven Eingriffen
Flat upper slide allows ideal visibility for minimally invasive surgery
Corredera plana posibilita una visión óptimal en intervenciones minimamente invasivas
Coulisse plate pour une visibilité optimale lors des interventions minimales invasives
L'asta piatto permette una vista ottimale per interventi mini-invasivi



Ergonomisches Design und Balance für höchste Präzision und Arbeitskomfort
Ergonomic design and balance for high precision and working comfort
Diseño ergonómico e equilibrado para la máxima precisión y confort de trabajo
Design et équilibre ergonomique pour une précision et un confort de travail maximal
Design ed equilibrio ergonomici per altissima precisione e comfort lavorativo

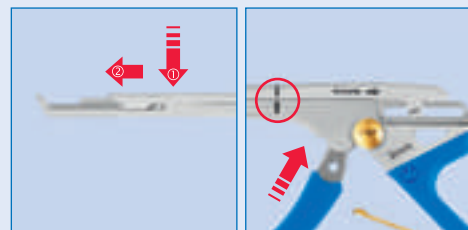
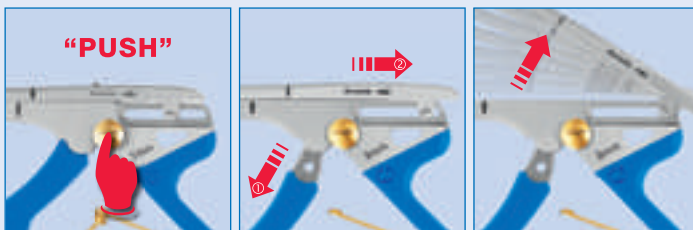

Einteilige Zerlegetechnik für einfache Demontage und Montage
One piece dismantable rongeur for easy disassembling and assembling
Pinza saca-bocada desmontable de una sola pieza para un desmontaje/montaje sencillo
Technique de démontage d'une pièce pour un montage et un démontage facile
Tecnica di smontaggio monopezzo per un smontaggio e montaggio facile

Zerlegbare Stanzen mit Silikongriff
Dismantable Rongeurs with Silicone Handle
Pinzas saca-bocadas desmontable con mango de silicona
Pinces emporte-pièce démontables avec manche en silicone
Laminotomi smontabili con manico in silicone



— b —

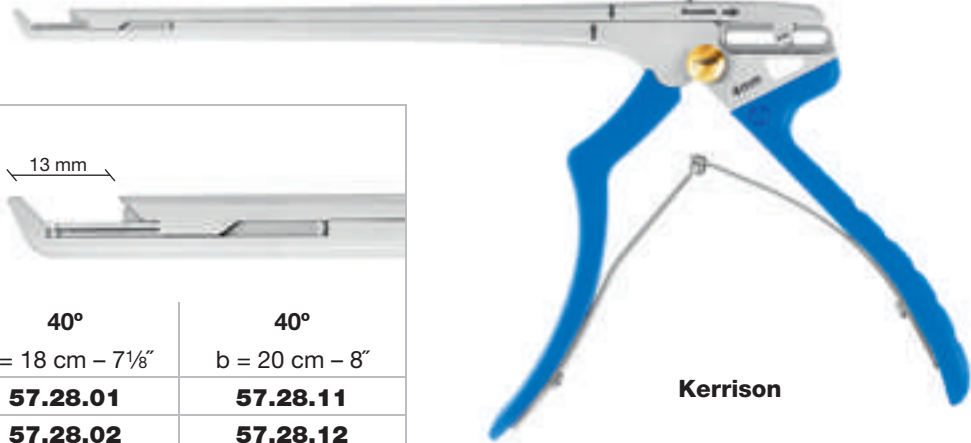

Stanzbreite Jaw width Ancho del corte Largeur des mors Larghezza de morso	D	
	40°	40°
a	b = 18 cm – 7 1/8"	b = 20 cm – 8"
1 mm	57.28.01	57.28.11
2 mm	57.28.02	57.28.12
3 mm	57.28.03	57.28.13
4 mm	57.28.04	57.28.14
5 mm	57.28.05	57.28.15
6 mm	57.28.06	57.28.16

Kerrison



mit Auswerfer
with ejector
con expulsor
avec éjecteur
con espulsore



— b —

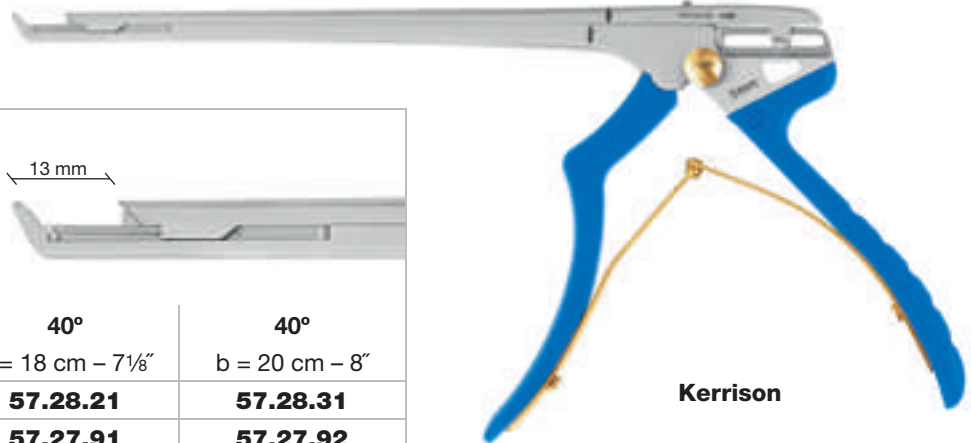

Stanzbreite Jaw width Ancho del corte Largeur des mors Larghezza de morso	D	
	40°	40°
a	b = 18 cm – 7 1/8"	b = 20 cm – 8"
1,0 mm	57.28.21	57.28.31
1,5 mm	57.27.91	57.27.92
2,0 mm	57.28.22	57.28.32
3,0 mm	57.28.23	57.28.33
4,0 mm	57.28.24	57.28.34
5,0 mm	57.28.25	57.28.35
6,0 mm	57.28.26	57.28.36

Kerrison

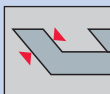

Breite Stanzplatte = graue Feder
Thick footplate = gray spring
Lámina de punzonar ancha = muelle gris
Plaque de poinçonnage large = ressort gris
Morso largo = molla grigia



Schmale Stanzplatte = goldene Feder
Narrow footplate = golden spring
Lámina de punzonar estrecha = muelle dorada
Plaque de poinçonnage étroite = ressort doré
Morso sottile = molla dorata

**B04**

Zerlegbare Stanzen mit Silikongriff
Dismantable Rongeurs with Silicone Handle
Pinzas saca-bocadas desmontable con mango de silicona
Pinces emporte-pièce démontables avec manche en silicone
Laminotomi smontabili con manico in silicone

Kerrison
...DieBLAUEN.

21
8
20
19
18
7
17
6
16
15
6
14
5
13
5
12
11
4
10
4
9
3
8
3
7
2
6
2
5
2
4
1
3
1
2
1
1
cm
inch

**EJECTOR**

b

Stanzbreite Jaw width Ancho del corte Largeur des mors Larghezza de morso	a	13 mm	90°	b = 18 cm - 7 1/8"
1 mm				57.28.41
2 mm				57.28.42
3 mm				57.28.43
4 mm				57.28.44
5 mm				57.28.45
6 mm				57.28.46

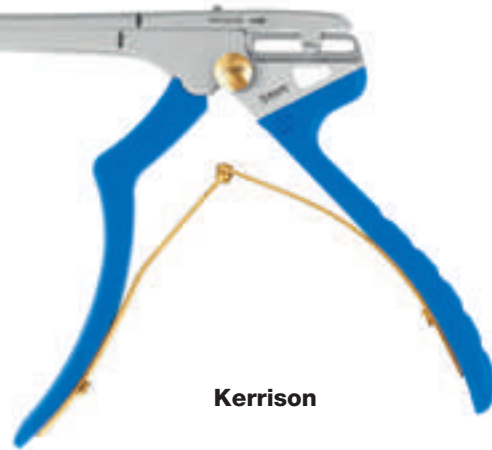
**Kerrison****EJECTOR**

b

Stanzbreite Jaw width Ancho del corte Largeur des mors Larghezza de morso	a	magic cut	
		40°	40°
		b = 18 cm - 7 1/8"	b = 20 cm - 8"
1 mm		57.28.51	57.28.61
2 mm		57.28.52	57.28.62
3 mm		57.28.53	57.28.63
4 mm		57.28.54	57.28.64
5 mm		57.28.55	57.28.65
6 mm		57.28.56	57.28.66

**Kerrison**

mit Auswerfer
with ejector
con espulsor
avec éjecteur
con espulsore

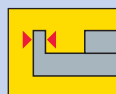

Schmale Stanzplatte = goldene Feder
Narrow footplate = golden spring
Lámina de punzonar estrecha = muelle dorada
Plaque de poinçonnage étroite = ressort doré
Morso sottile = molla dorata

Kerrison
...DieBLAUEN.

Zerlegbare Stanzen mit Silikongriff
Dismantable Rongeurs with Silicone Handle
Pinza saca-bocada desmontable con mango de silicona
Pinces emporte-pièce démontables avec manche en silicone
Laminotomi smontabili con manico in silicone

B04

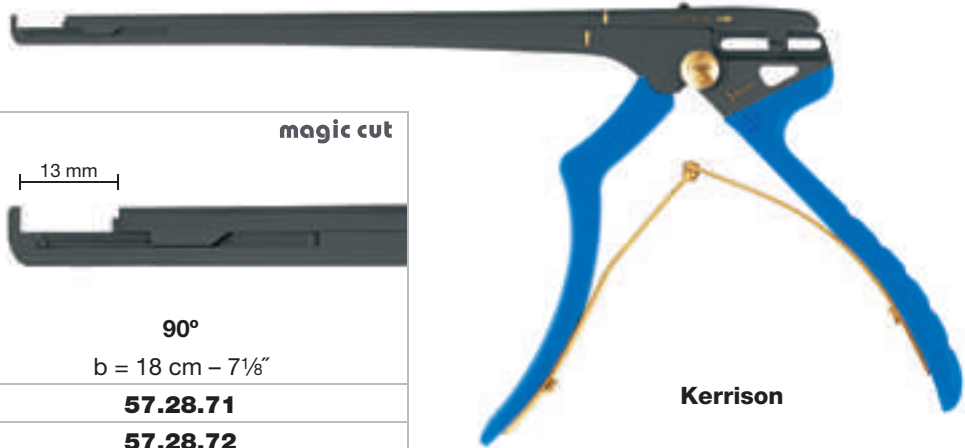
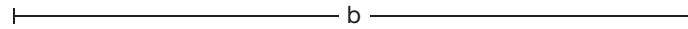

Stanzbreite Jaw width Ancho del corte Largeur des mors Larghezza de morso	magic cut
a	13 mm
	90°
	b = 18 cm - 7 1/8"
1 mm	57.28.71
2 mm	57.28.72
3 mm	57.28.73
4 mm	57.28.74
5 mm	57.28.75
6 mm	57.28.76



Lange Standzeit, hohe Oberflächenhärte und blendfreie Oberfläche
 Long lasting cutting ability, high surface hardness and non-dazzling surface
 Máxima duración del corte, alta dureza de la superficie y superficie antideslumbrante
 Longue durée de vie, grande dureté de la surface et surface non-éblouissante
 Massima durata del taglio, alta durezza della superficie e superficie antiriflesso

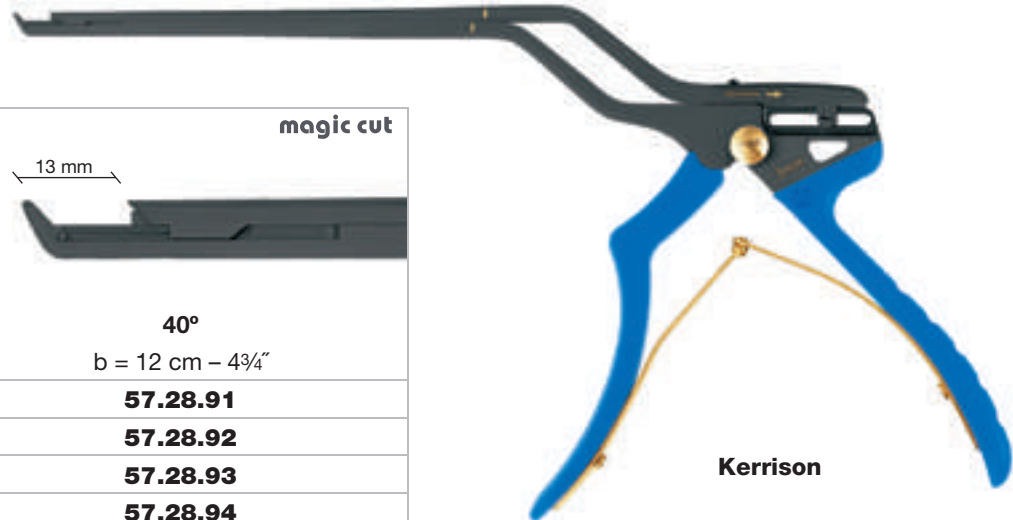
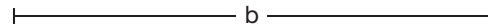

Stanzbreite Jaw width Ancho del corte Largeur des mors Larghezza de morso	magic cut
a	13 mm
	40°
	b = 12 cm - 4 3/4"
1 mm	57.28.91
2 mm	57.28.92
3 mm	57.28.93
4 mm	57.28.94
5 mm	57.28.95
6 mm	57.28.96



mit Auswerfer
with ejector
con espulsor
avec éjecteur
con espulsore



Schmale Stanzplatte = goldene Feder
 Narrow footplate = golden spring
 Lámina de punzonar estrecha = muelle dorada
 Plaque de poinçonnage étroite= ressort doré
 Morso sottile = molla dorata

**B04**

Zerlegbare Stanzen mit Silikongriff
Dismantable Rongeurs with Silicone Handle
Pinzas saca-bocadas desmontable con mango de silicona
Pinces emporte-pièce démontables avec manche en silicone
Laminotomi smontabili con manico in silicone

Kerrison
 ...DieBLAUEN
 Cervical

21
8
20
19
18
7
17
6
16
15
14
5
13
12
11
4
10
9
3
8
7
6
2
5
4
3
1
2
1
cm
inch



EJECTOR

b

Stanzbreite Jaw width Ancho del corte Largeur des mors Larghezza de morso	D	
	a	b
	40° b = 18 cm – 7 1/8"	40° b = 20 cm – 8"
1 mm	57.30.21	57.30.31
2 mm	57.30.22	57.30.32
3 mm	57.30.23	57.30.33
4 mm	57.30.24	57.30.34

13 mm



Kerrison

FOR CERVICAL
USE ONLY

Anwendung ausschließlich an der zervikalen Wirbelsäule!

For use on the cervical spine only!

Para uso exclusivo en la columna vertebral cervical!

Peuvent être utilisées exclusivement sur la colonne vertébrale cervicale!

Può essere utilizzato esclusivamente sulla colonna vertebrale cervicale!

b



EJECTOR

Stanzbreite Jaw width Ancho del corte Largeur des mors Larghezza de morso	D	
	a	b
	40° b = 18 cm – 7 1/8"	40° b = 20 cm – 8"
1 mm	57.30.51	57.30.61
2 mm	57.30.52	57.30.62
3 mm	57.30.53	57.30.63
4 mm	57.30.54	57.30.64

magic cut

13 mm



Kerrison

magic cut

Lange Standzeit, hohe Oberflächenhärte und blendfreie Oberfläche
 Long lasting cutting ability, high surface hardness and non-dazzling surface
 Máxima duración del corte, alta dureza de la superficie y superficie antideslumbrante
 Longue durée de vie, grande dureté de la surface et surface non-éblouissante
 Massima durata del taglio, alta durezza della superficie e superficie antiriflesso



mit Auswerfer
 with ejector
 con espulsor
 avec éjecteur
 con espulsore

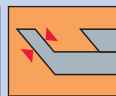

Extra schmale Stanzplatte = schwarze Feder
 Extra narrow footplate = black spring
 Lámina de punzonar extra estrecha = muelle negra
 Plaque de poinçonnage extra étroite = ressort noire
 Morso extra sottile = molla nera

Stanzen
Rongeurs
Pinzas saca-bocadas
Pinces emporte-pièce
Laminotomi

B04

Stanzbreite Jaw width Ancho del corte Largeur des mors Larghezza de morso	D	
	a	b
	90° b = 18 cm – 7 1/8"	90° b = 20 cm – 8"
2 mm	57.03.02	57.04.02
3 mm	57.03.03	57.04.03
4 mm	57.03.04	57.04.04
5 mm	57.03.05	57.04.05
6 mm	57.03.06	57.04.06

Kerrison (Spurling)

Griff (groß)
 Handle (large)
 Mango (grande)
 Manche (grand)
 Manico (grande)

Stanzbreite Jaw width Ancho del corte Largeur des mors Larghezza de morso	D	
	a	b
	90° b = 18 cm – 7 1/8"	90° b = 20 cm – 8"
2 mm	57.05.12	57.04.12
3 mm	57.05.13	57.04.13
4 mm	57.05.14	57.04.14
5 mm	57.05.15	57.04.15
6 mm	57.05.16	57.04.16

Kerrison (Spurling)

Breite Stanzplatte = graue Feder
 Thick footplate = gray spring
 Lámina de punzonar ancha = muelle gris
 Plaque de poinçonnage large = ressort gris
 Morso largo = molla grigia



Stanzen
Rongeurs
Pinzas saca-bocadas
Pinces emporte-pièce
Laminotomi

B04

21
8
20
19
18
7
17
16
6
15
14
5
13
12
11
4
10
9
3
8
7
6
2
5
4
1
3
2
1
cm | inch



Stanzbreite Jaw width Ancho del corte Largeur des mors Larghezza de morso	D a I
a	15 mm 40° b = 18 cm - 7 1/8"
3 mm	57.03.23
4 mm	57.03.24
5 mm	57.03.25
6 mm	57.03.26

b

**Kerrison (Spurling)**

Griff (groß)
 Handle (large)
 Mango (grande)
 Manche (grand)
 Manico (grande)



Stanzbreite Jaw width Ancho del corte Largeur des mors Larghezza de morso	D a I
a	15 mm 40° 40° b = 20 cm - 8" b = 28 cm - 11"
3 mm	57.04.23 57.04.73
4 mm	57.04.24 57.04.74
5 mm	57.04.25 57.04.75
6 mm	57.04.26 57.04.76

b

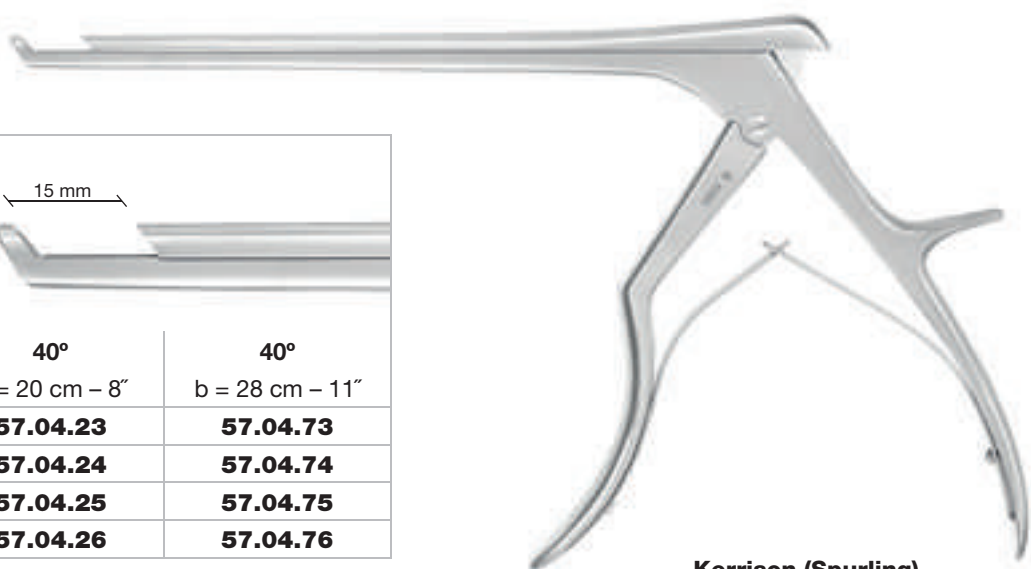
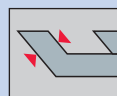
**Kerrison (Spurling)**

Breite Stanzplatte = graue Feder
 Thick footplate = gray spring
 Lámina de punzonar ancha = muelle gris
 Plaque de poinçonnage large = ressort gris
 Morso largo = molla grigia

Stanzbreite Jaw width Ancho del corte Largeur des mors Larghezza de morso a	rechts schneidend right side cutting cortante hacia derecha coupante à droite tagliente a destra
	90° / 40° b = 20 cm - 8"
3 mm	57.04.43
5 mm	57.04.45

Kerrison (Spurling)

Griff (groß)
 Handle (large)
 Mango (grande)
 Manche (grand)
 Manico (grande)

Stanzbreite Jaw width Ancho del corte Largeur des mors Larghezza de morso a	links schneidend left side cutting cortante hacia izquierda coupante à gauche tagliente a sinistra
	90° / 40° b = 20 cm - 8"
3 mm	57.04.53
5 mm	57.04.55

Kerrison (Spurling)

Breite Stanzplatte = graue Feder
 Thick footplate = gray spring
 Lámina de punzonar ancha = muelle gris
 Plaque de poinçonnage large = ressort gris
 Morso largo = molla grigia



Stanzen
Rongeurs
Pinzas saca-bocadas
Pinces emporte-pièce
Laminotomi

B04

21
8
20
19
18
7
17
16
6
15
6
14
5
13
5
12
11
4
10
4
9
3
8
3
7
2
6
2
5
2
4
3
1
3
2
1
cm
inch



Stanzbreite Jaw width Ancho del corte Largeur des mors Larghezza de morso	D	
	90°	90°
a	b = 18 cm - 7 1/8"	b = 20 cm - 8"
3 mm	57.06.57	57.06.53
5 mm	57.06.59	57.06.55

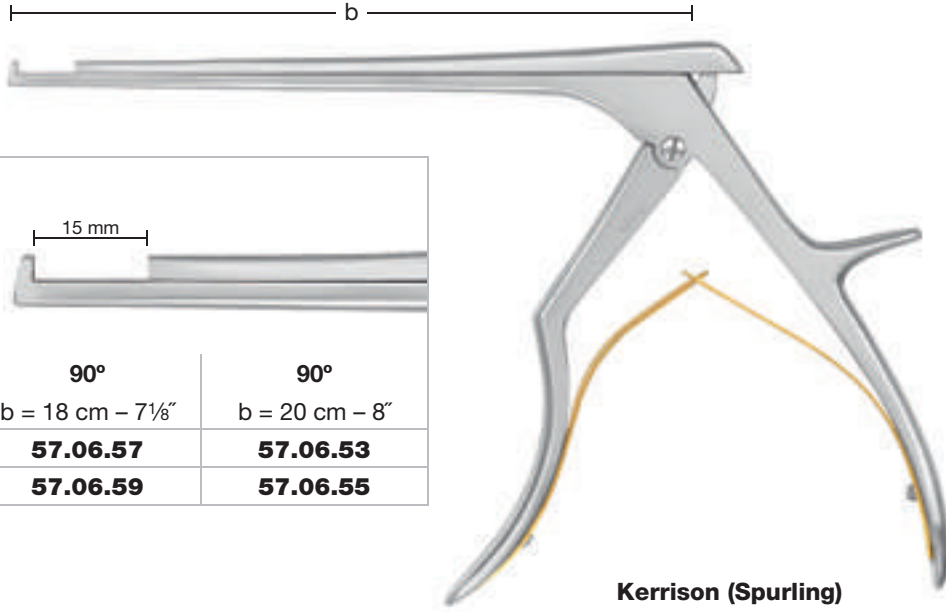

Kerrison (Spurling)



Griff (groß)
 Handle (large)
 Mango (grande)
 Manche (grand)
 Manico (grande)

Stanzbreite Jaw width Ancho del corte Largeur des mors Larghezza de morso	D	
	90°	90°
a	b = 18 cm - 7 1/8"	b = 20 cm - 8"
3 mm	57.06.67	57.06.63
5 mm	57.06.69	57.06.65

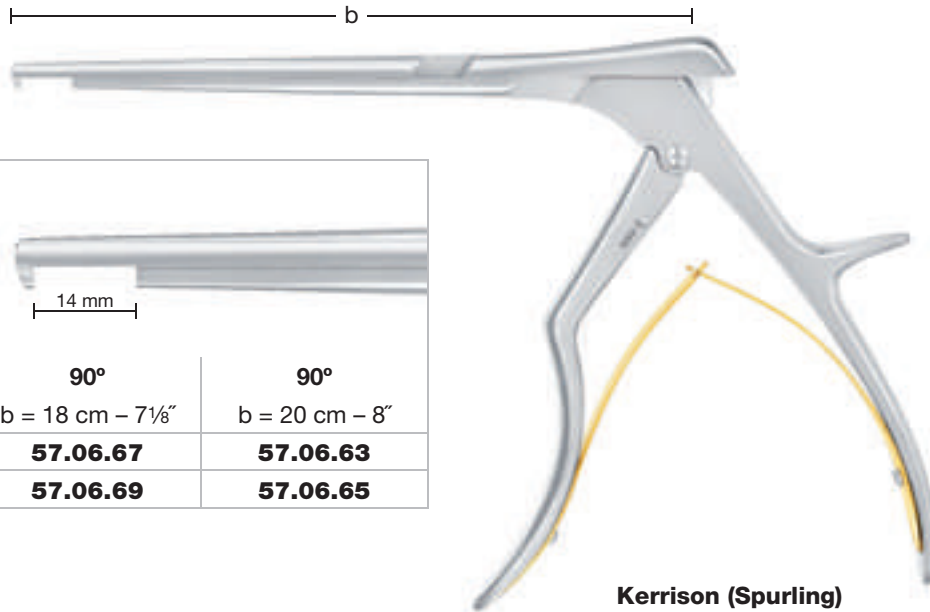

Kerrison (Spurling)

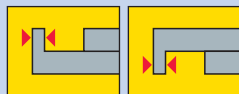

Schmale Stanzplatte = goldene Feder
 Narrow footplate = golden spring
 Lámina de punzonar estrecha = muelle dorada
 Plaque de poinçonnage étroite = ressort doré
 Morso sottile = molla dorata

Stanzbreite Jaw width Ancho del corte Largeur des mors Larghezza de morso	15 mm 40°	40°	
	a	b = 18 cm - 7 1/8"	b = 20 cm - 8"
	3 mm	57.06.93	57.06.73
5 mm	57.06.95	57.06.75	

Kerrison (Schlesinger)

Griff (groß)
 Handle (large)
 Mango (grande)
 Manche (grand)
 Manico (grande)

Stanzbreite Jaw width Ancho del corte Largeur des mors Larghezza de morso	14 mm 40°	40°	
	a	b = 18 cm - 7 1/8"	b = 20 cm - 8"
	3 mm	57.06.43	57.06.83
5 mm	57.06.45	57.06.85	

Kerrison (Schlesinger)

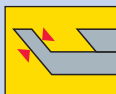

Schmale Stanzplatte = goldene Feder
 Narrow footplate = golden spring
 Lámina de punzonar estrecha = muelle dorada
 Plaque de poinçonnage étroite = ressort doré
 Morso sottile = molla dorata

**B04**

Stanzen
Rongeurs
Pinzas saca-bocadas
Pinces emporte-pièce
Laminotomi

21
8
20
19
18
7
17
16
6
15
14
5
13
12
11
4
10
9
3
8
7
6
2
5
4
1
3
2
1
cm
inch

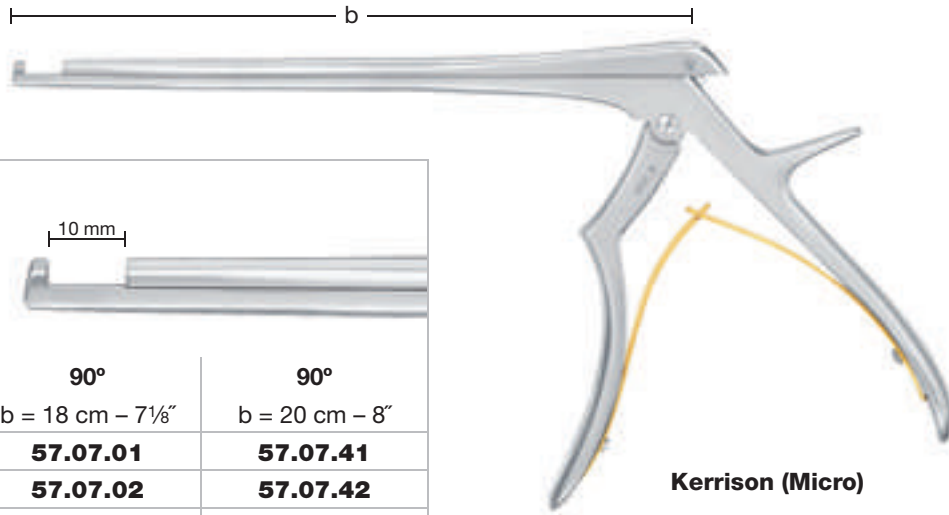

Stanzbreite Jaw width Ancho del corte Largeur des mors Larghezza de morso	D Ta I	
	90° a	90° b
1 mm	b = 18 cm - 7 1/8"	b = 20 cm - 8"
2 mm	57.07.01	57.07.41
3 mm	57.07.02	57.07.42
4 mm	57.07.03	57.07.43
5 mm	57.07.04	57.07.44
6 mm	57.07.05	57.07.45
6 mm	57.07.06	57.07.46

**Kerrison (Micro)**

Griff (klein)
 Handle (small)
 Mango (pequeño)
 Manche (petit)
 Manico (piccolo)

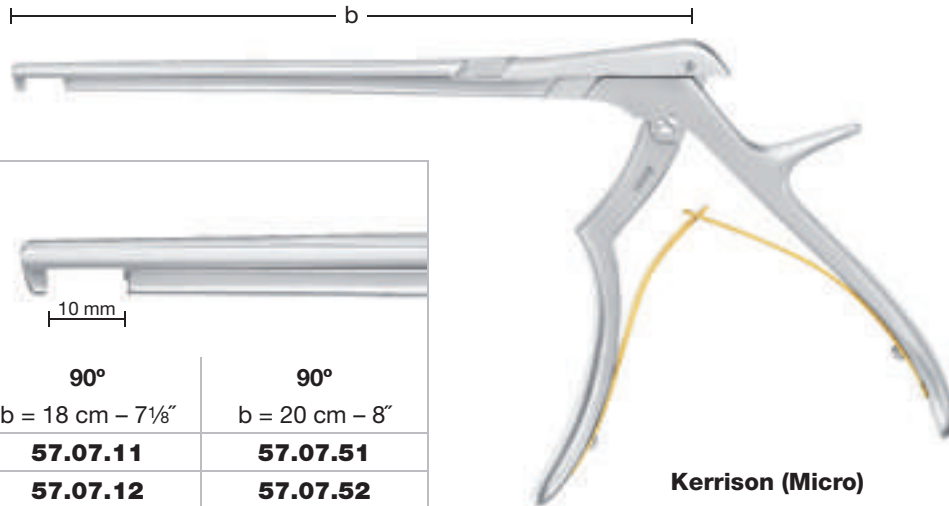
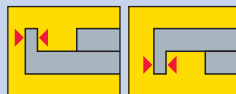

Stanzbreite Jaw width Ancho del corte Largeur des mors Larghezza de morso	D Ta I	
	90° a	90° b
1 mm	b = 18 cm - 7 1/8"	b = 20 cm - 8"
2 mm	57.07.11	57.07.51
3 mm	57.07.12	57.07.52
4 mm	57.07.13	57.07.53
5 mm	57.07.14	57.07.54
6 mm	57.07.15	57.07.55
6 mm	57.07.16	57.07.56

**Kerrison (Micro)**

Schmale Stanzplatte = goldene Feder
 Narrow footplate = golden spring
 Lámina de punzonar estrecha = muelle dorada
 Plaque de poinçonnage étroite = ressort doré
 Morso sottile = molla dorata

Stanzen
Rongeurs
Pinzas saca-bocadas
Pinces emporte-pièce
Laminotomi

B04

Stanzbreite Jaw width Ancho del corte Largeur des mors Larghezza de morso	40°	
	a	b = 18 cm - 7 1/8"
1 mm	57.07.21	57.07.61
2 mm	57.07.22	57.07.62
3 mm	57.07.23	57.07.63
4 mm	57.07.24	57.07.64
5 mm	57.07.25	57.07.65
6 mm	57.07.26	57.07.66

Kerrison (Micro)



Stanzbreite Jaw width Ancho del corte Largeur des mors Larghezza de morso	40°	
	a	b = 18 cm - 7 1/8"
1 mm	57.07.31	57.07.71
2 mm	57.07.32	57.07.72
3 mm	57.07.33	57.07.73
4 mm	57.07.34	57.07.74
5 mm	57.07.35	57.07.75
6 mm	57.07.36	57.07.76

Kerrison (Micro)

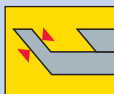

Schmale Stanzplatte = goldene Feder
 Narrow footplate = golden spring
 Lámina de punzonar estrecha = muelle dorada
 Plaque de poinçonnage étroite = ressort doré
 Morso sottile = molla dorata



Stanzen
Rongeurs
Pinzas saca-bocadas
Pinces emporte-pièce
Laminotomi

B04

21
8
20
19
18
7
17
16
6
15
14
5
13
12
11
4
10
9
3
8
7
6
2
5
4
3
1
2
1
cm
inch



— b —

Stanzbreite Jaw width Ancho del corte Largeur des mors Larghezza de morso	D a I	
	90° b = 18 cm - 7 1/8"	90° b = 20 cm - 8"
1 mm	57.08.21	57.08.61
2 mm	57.08.22	57.08.62
3 mm	57.08.23	57.08.63
4 mm	57.08.24	57.08.64
5 mm	57.08.25	57.08.65
6 mm	57.08.26	57.08.66

**Kerrison (Micro)**

Griff (klein)
 Handle (small)
 Mango (pequeño)
 Manche (petit)
 Manico (piccolo)

— b —

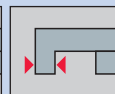
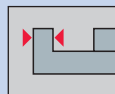

Stanzbreite Jaw width Ancho del corte Largeur des mors Larghezza de morso	D a I	
	90° b = 18 cm - 7 1/8"	90° b = 20 cm - 8"
1 mm	57.08.31	57.08.71
2 mm	57.08.32	57.08.72
3 mm	57.08.33	57.08.73
4 mm	57.08.34	57.08.74
5 mm	57.08.35	57.08.75
6 mm	57.08.36	57.08.76

**Kerrison (Micro)**

Breite Stanzplatte = graue Feder
 Thick footplate = gray spring
 Lámina de punzonar ancha = muelle gris
 Plaque de poinçonnage large = ressort gris
 Morso largo = molla grigia

Stanzen
Rongeurs
Pinzas saca-bocadas
Pinces emporte-pièce
Laminotomi

B04

 Stanzbreite Jaw width Ancho del corte Largeur des mors Larghezza de morso a		
	40° b = 18 cm - 7 1/8"	40° b = 20 cm - 8"
1 mm	57.08.41	57.08.81
2 mm	57.08.42	57.08.82
3 mm	57.08.43	57.08.83
4 mm	57.08.44	57.08.84
5 mm	57.08.45	57.08.85
8 mm	57.08.46	57.08.86

Kerrison (Micro)

 Stanzbreite Jaw width Ancho del corte Largeur des mors Larghezza de morso a		
	40° b = 18 cm - 7 1/8"	40° b = 20 cm - 8"
1 mm	57.07.31	57.07.71
2 mm	57.07.32	57.07.72
3 mm	57.07.33	57.07.73
4 mm	57.07.34	57.07.74
5 mm	57.07.35	57.07.75
6 mm	57.07.36	57.07.76

Kerrison (Micro)

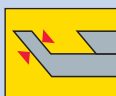

Schmale Stanzplatte = goldene Feder
 Narrow footplate = golden spring
 Lámina de punzonar estrecha = muelle dorada
 Plaque de poinçonnage étroite = ressort doré
 Morso sottile = molla dorata



Stanzen
Rongeurs
Pinzas saca-bocadas
Pinces emporte-pièce
Laminotomi

B04

21
8
20
19
18
7
17
16
6
15
14
13
5
12
11
4
10
9
3
7
6
2
5
4
1
3
2
1
cm inch

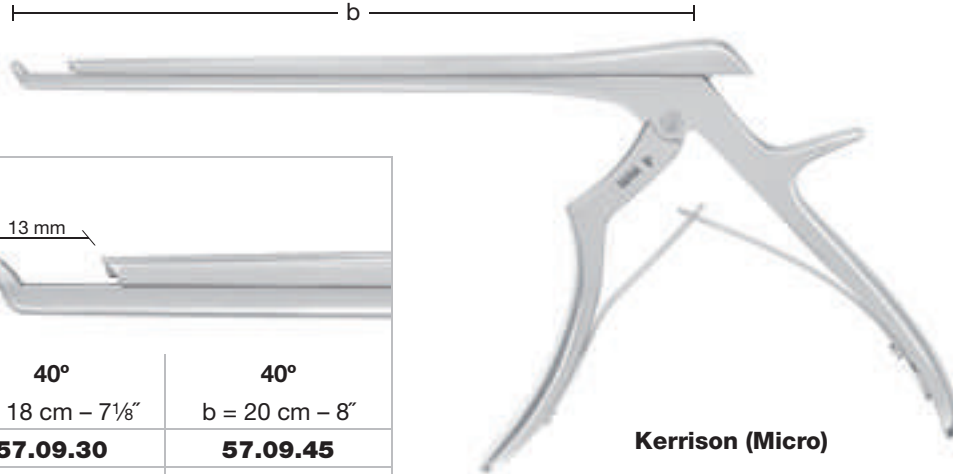

Stanzbreite Jaw width Ancho del corte Largeur des mors Larghezza de morso	D	
	a	
	40° b = 18 cm – 7 1/8"	40° b = 20 cm – 8"
2 mm	57.09.30	57.09.45
3 mm	57.09.31	57.09.46
4 mm	57.09.32	57.09.47
5 mm	57.09.33	57.09.48
6 mm	57.09.34	57.09.49

**Kerrison (Micro)**

Griff (klein)
 Handle (small)
 Mango (pequeño)
 Manche (petit)
 Manico (piccolo)

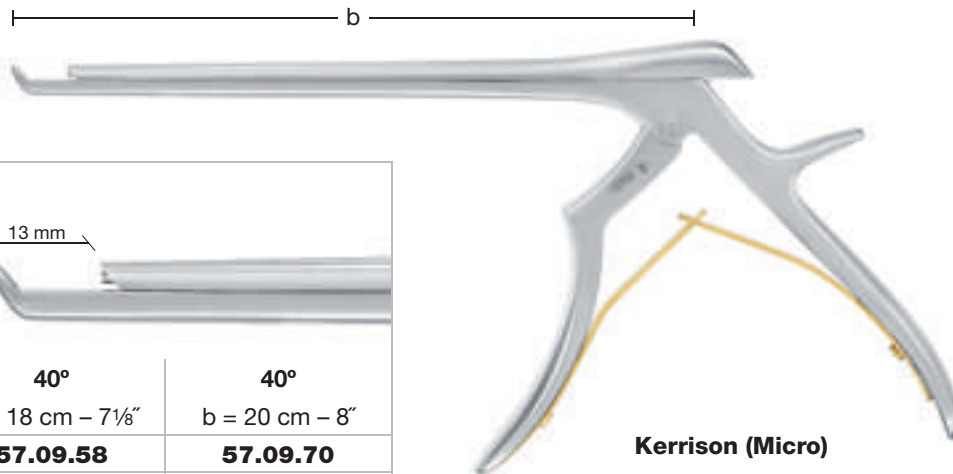
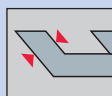

Stanzbreite Jaw width Ancho del corte Largeur des mors Larghezza de morso	D	
	a	
	40° b = 18 cm – 7 1/8"	40° b = 20 cm – 8"
2 mm	57.09.58	57.09.70
3 mm	57.09.59	57.09.71
4 mm	57.09.60	57.09.72
5 mm	57.09.61	57.09.73

**Kerrison (Micro)**

Breite Stanzplatte = graue Feder
 Thick footplate = gray spring
 Lámina de punzonar ancha = muelle gris
 Plaque de poinçonnage large = ressort gris
 Morso largo = molla grigia

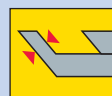

Schmale Stanzplatte = goldene Feder
 Narrow footplate = golden spring
 Lámina de punzonar estrecha = muelle dorada
 Plaque de poinçonnage étroite = ressort doré
 Morso sottile = molla dorata



Stanzbreite Jaw width Ancho del corte Largeur des mors Larghezza de morso	D	
	90°	90°
a	b = 18 cm – 7 1/8"	b = 20 cm – 8"
2 mm	57.09.50	57.09.62
3 mm	57.09.51	57.09.63
4 mm	57.09.52	57.09.64
5 mm	57.09.53	57.09.65

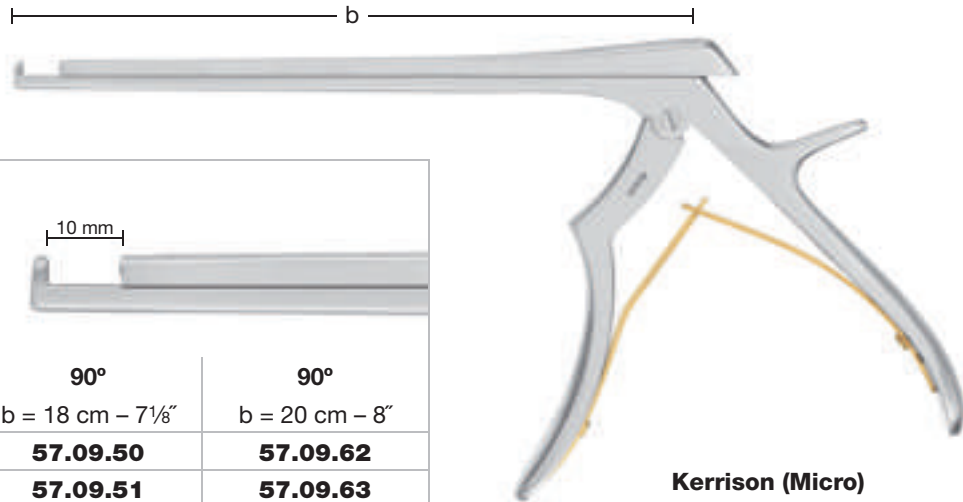

Kerrison (Micro)



Griff (klein)
Handle (small)
Mango (pequeño)
Manche (petit)
Manico (piccolo)



Stanzbreite Jaw width Ancho del corte Largeur des mors Larghezza de morso	D	
	90°	90°
a	b = 18 cm – 7 1/8"	b = 20 cm – 8"
2 mm	57.09.54	57.09.66
3 mm	57.09.55	57.09.67
4 mm	57.09.56	57.09.68
5 mm	57.09.57	57.09.69

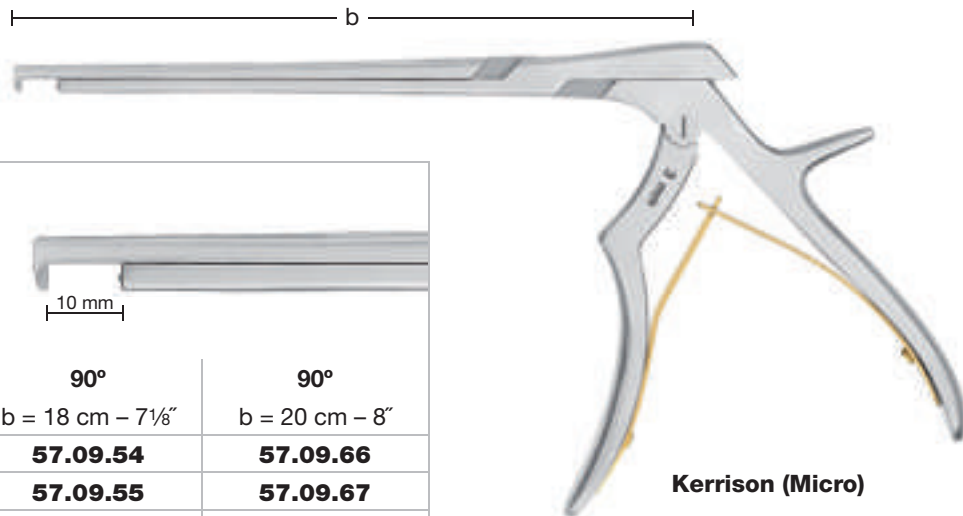

Kerrison (Micro)



mit Auswerfer
with ejector
con expulsor
avec éjecteur
con espulsore

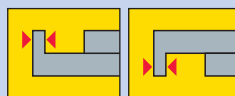

Schmale Stanzplatte = goldene Feder
Narrow footplate = golden spring
Lámina de punzonar estrecha = muelle dorada
Plaque de poinçonnage étroite = ressort doré
Morso sottile = molla dorata



Stanzen
Rongeurs
Pinzas saca-bocadas
Pinces emporte-pièce
Laminotomi

B04

21
8
20
19
18
7
17
16
6
15
14
5
13
12
11
4
10
9
3
8
7
6
2
5
4
3
1
2
1
cm inch



b

Stanzbreite Jaw width Ancho del corte Largeur des mors Larghezza de morso	 40° b = 20 cm - 8"
1 mm	57.07.77
2 mm	57.07.78
3 mm	57.07.79
4 mm	57.07.80
5 mm	57.07.81
6 mm	57.07.82

Langhub
 Long hub
 Abertura larga
 Longue course
 Corsa lunga



Kerrison (Micro)



Griff (klein)
 Handle (small)
 Mango (pequeño)
 Manche (petit)
 Manico (piccolo)

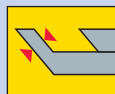

Schmale Stanzplatte = goldene Feder
 Narrow footplate = golden spring
 Lámina de punzonar estrecha = muelle dorada
 Plaque de poinçonnage étroite = ressort doré
 Morso sottile = molla dorata

Stanzen
Rongeurs
Pinzas saca-bocadas
Pinces emporte-pièce
Laminotomi

B04

Stanzbreite Jaw width Ancho del corte Largeur des mors Larghezza de morso	
	90° b = 18 cm – 7 1/8"
a 5 mm	57.10.05

Kerrison (Ferris-Smith)

Griff (klein)
 Handle (small)
 Mango (pequeño)
 Manche (petit)
 Manico (piccolo)

Stanzbreite Jaw width Ancho del corte Largeur des mors Larghezza de morso	
	90° b = 18 cm – 7 1/8"
a 5 mm	57.10.15

Kerrison (Ferris-Smith)

Schmale Stanzplatte = goldene Feder
 Narrow footplate = golden spring
 Lámina de punzonar estrecha = muelle dorada
 Plaque de poinçonnage étroite = ressort doré
 Morso sottile = molla dorata



Stanzen
Rongeurs
Pinzas saca-bocadas
Pinces emporte-pièce
Laminotomi

B04

21
8
20
19
18
7
17
16
6
15
14
13
5
12
11
4
10
9
3
8
7
6
2
5
4
3
1
2
1
cm
inch

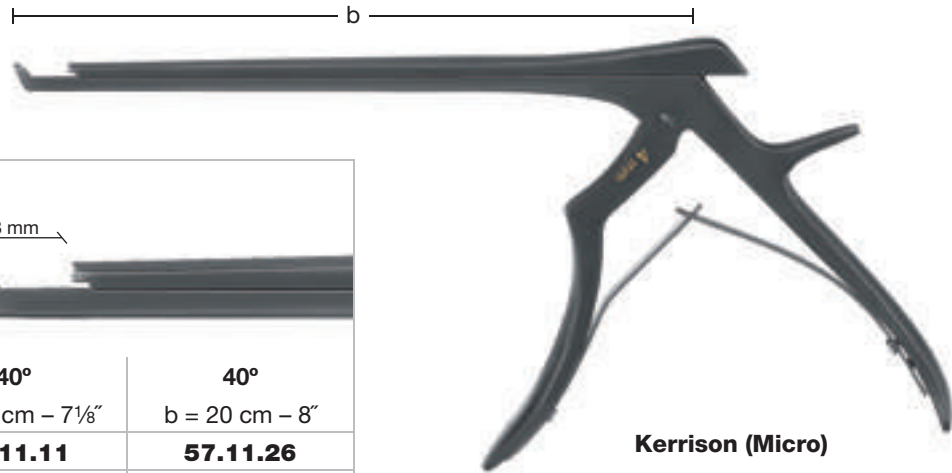

Stanzbreite Jaw width Ancho del corte Largeur des mors Larghezza de morso	D	
	a	
	40° b = 18 cm - 7 1/8"	40° b = 20 cm - 8"
2 mm	57.11.11	57.11.26
3 mm	57.11.12	57.11.27
4 mm	57.11.13	57.11.28
5 mm	57.11.14	57.11.29
6 mm	57.11.15	57.11.30



Griff (klein)
 Handle (small)
 Mango (pequeño)
 Manche (petit)
 Manico (piccolo)



mit Auswerfer
 with ejector
 con expulsor
 avec éjecteur
 con espulsore

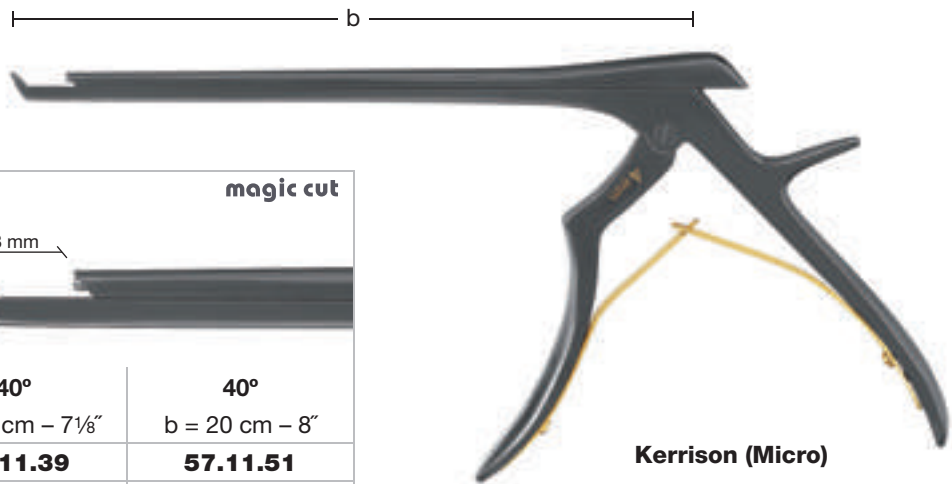

Stanzbreite Jaw width Ancho del corte Largeur des mors Larghezza de morso	D	
	a	
	40° b = 18 cm - 7 1/8"	40° b = 20 cm - 8"
2 mm	57.11.39	57.11.51
3 mm	57.11.40	57.11.52
4 mm	57.11.41	57.11.53
5 mm	57.11.42	57.11.54



Lange Standzeit, hohe Oberflächenhärte und blendfreie Oberfläche
 Long lasting cutting ability, high surface hardness and non-dazzling surface
 Máxima duración del corte, alta dureza de la superficie y superficie antideslumbrante
 Longue durée de vie, grande dureté de la surface et surface non-éblouissante
 Massima durata del taglio, alta durezza della superficie e superficie antiriflesso



Breite Stanzplatte = graue Feder
 Thick footplate = gray spring
 Lámina de punzonar ancha = muelle gris
 Plaque de poinçonnage large = ressort gris
 Morso largo = molla grigia



Schmale Stanzplatte = goldene Feder
 Narrow footplate = golden spring
 Lámina de punzonar estrecha = muelle dorada
 Plaque de poinçonnage étroite = ressort doré
 Morso sottile = molla dorata

drehbar
 rotatable
 giratoria
 rotatif
 girevole

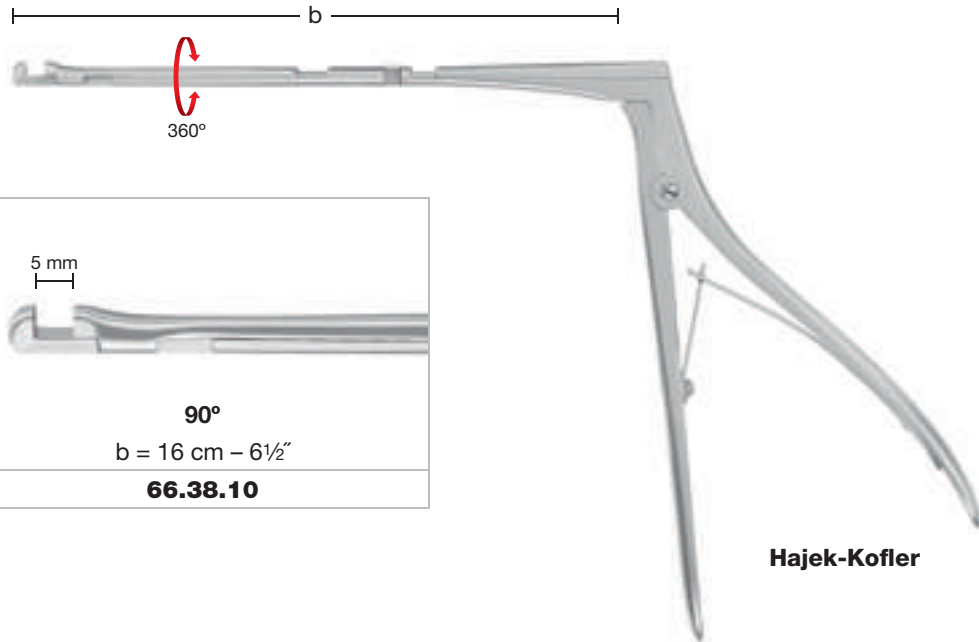

Hajek-Kofler

Stanzbreite Jaw width Ancho del corte Largeur des mors Larghezza de morso	D 5 mm
	a 90° b = 16 cm - 6 1/2"
3 mm	66.38.10

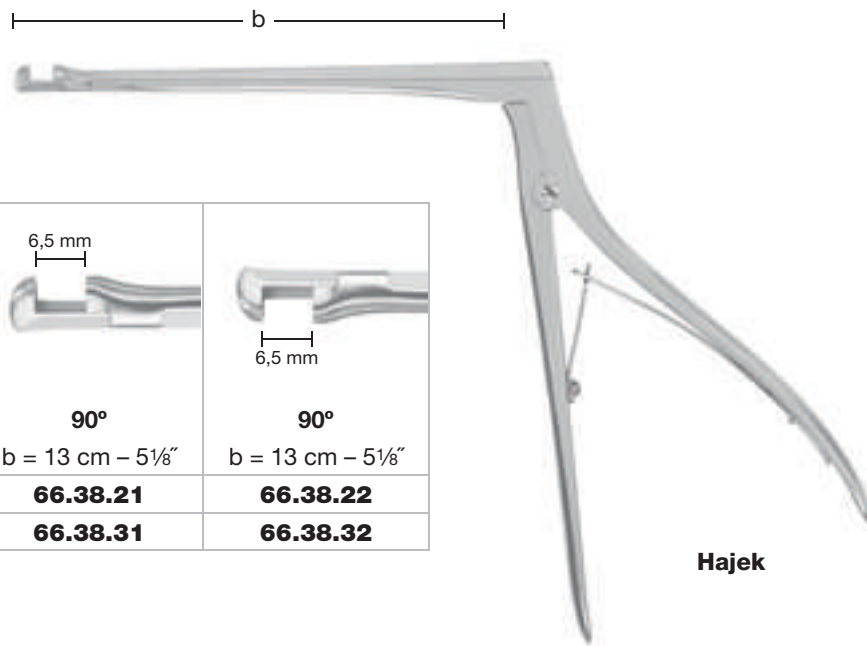

Hajek

Stanzbreite Jaw width Ancho del corte Largeur des mors Larghezza de morso	D 6,5 mm 	D 6,5 mm
	a 90° b = 13 cm - 5 1/8"	90° b = 13 cm - 5 1/8"
3,5 mm	66.38.21	66.38.22
4,0 mm	66.38.31	66.38.32



Stanzen
Rongeurs
Pinzas saca-bocadas
Pinces emporte-pièce
Laminotomi

B04

	Stanzbreite Jaw width Ancho del corte Largeur des mors Larghezza de morso	 11 mm 90° b = 8 cm - 3 1/8"
#0	2 mm	62.62.03
#1	4 mm	62.62.04
#2	5 mm	62.62.05

**Kerrison**

	Stanzbreite Jaw width Ancho del corte Largeur des mors Larghezza de morso	 6 mm 90° b = 6 cm - 2 3/8"
#1	1,5 mm	62.62.51
#2	2,5 mm	62.62.52
#3	4,0 mm	62.62.53

gezahnt
serrated
dentada
dentelée
dentellato

**Citelli**

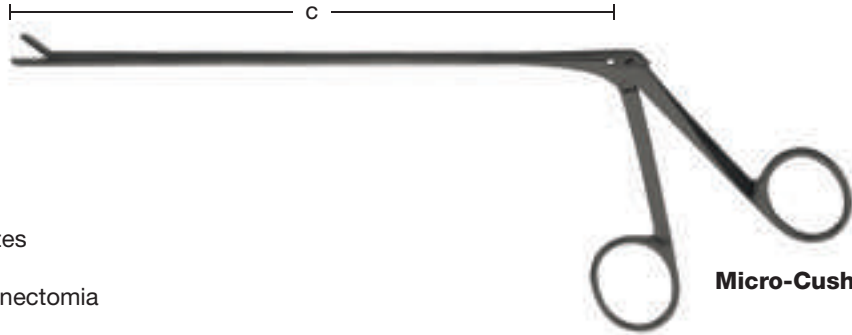
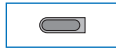

Mikro-Rongeur
Micro rongeurs
Micro pinzas cortantes
Micro rongeurs
Micro pinze per laminectomia

Micro-Cushing

		gerade straight recta droit retta	aufgewinkelt angled upwards angulada hacia arriba coudé en haut angolata verso l'alto	gerade und gezahnt straight and serrated recta y dentadas droit et dentés retta e dentellato
Maulbreite Jaw width Ancho de la boca Largeur des mors Larghezza del morso a	Maullänge Jaw length Longitud de la boca Longueur des mors Lunghezza del morso b	<p>magic cut 30° c = 16 cm – 6¼"</p>	<p>magic cut 30° c = 16 cm – 6¼"</p>	<p>c = 16 cm – 6¼"</p>
2 mm	5 mm	57.11.80	57.11.81	57.11.82



Lange Standzeit, hohe Oberflächenhärte und blendfreie Oberfläche
Long lasting cutting ability, high surface hardness and non-dazzling surface
Máxima duración del corte, alta dureza de la superficie y superficie antideslumbrante
Longue durée de vie, grande dureté de la surface et surface non-éblouissante
Massima durata del taglio, alta durezza della superficie e superficie antiriflesso



		gerade straight recta droit retta	aufgewinkelt angled upwards angulada hacia arriba coudé en haut angolata verso l'alto
Maulbreite Jaw width Ancho de la boca Largeur des mors Larghezza del morso a	Maullänge Jaw length Longitud de la boca Longueur des mors Lunghezza del morso b	<p>magic cut c = 18 cm – 7⅞"</p>	<p>magic cut 30° c = 18 cm – 7⅞"</p>
2 mm	10 mm	57.11.90	57.11.91

Cushing



Vergrößerung
Magnification
Engrandecimiento
Agrandissement
Ingrandimento

**B04**

Rongeur
Rongeurs
Pinzas cortantes
Rongeurs
Pinze per laminectomia

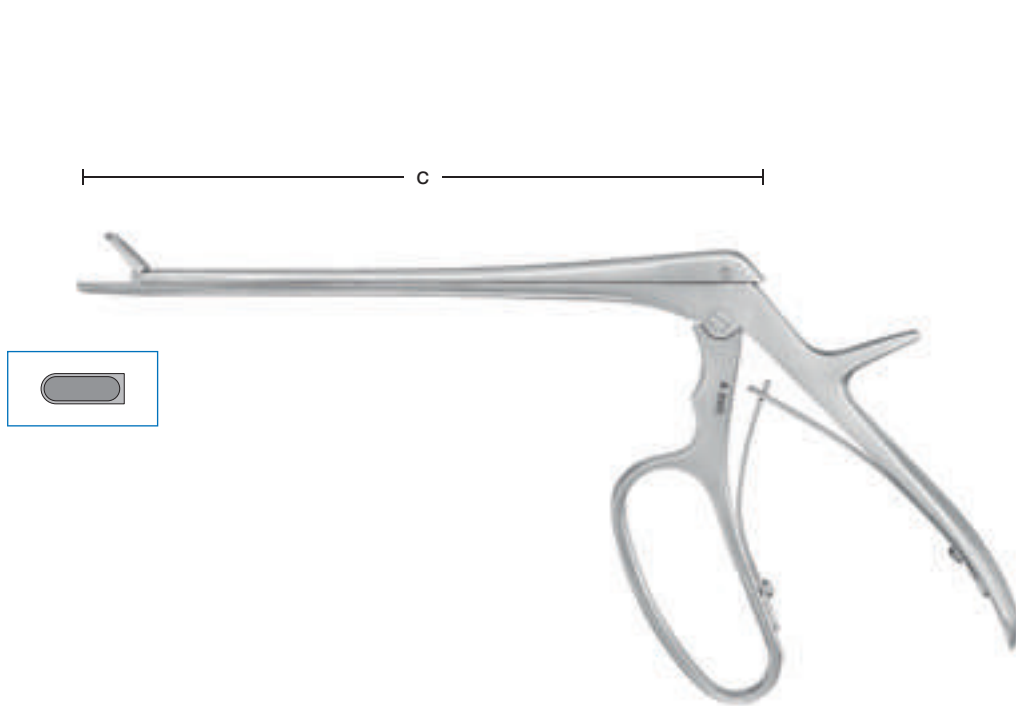
**Ferris-Smith-Spurling**

		gerade straight recta droit retta	aufgewinkelt angled upwards angulada hacia arriba coudé en haut angolata verso l'alto	abgewinkelt angled downwards angulada hacia abajo coudé en bas angolata verso il basso
Maulbreite Jaw width Ancho de la boca Largeur des mors Larghezza del morso a	Maullänge Jaw length Longitud de la boca Longueur des mors Lunghezza del morso b			
		c = 18 cm – 7 1/8"	c = 18 cm – 7 1/8"	c = 18 cm – 7 1/8"
2 mm	10 mm	57.12.20	57.13.20	57.14.20
3 mm	10 mm	57.12.30	57.13.30	57.14.30
4 mm	10 mm	57.12.40	57.13.40	57.14.40
6 mm	12 mm	57.12.62		





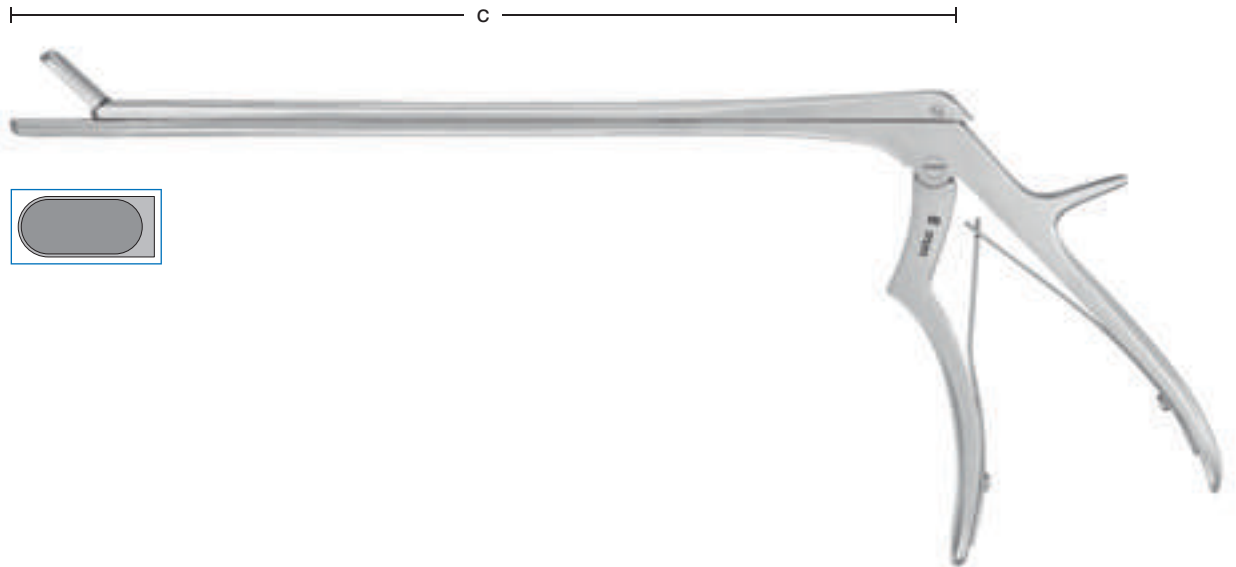

Rongeur
 Rongeurs
 Pinzas cortantes
 Rongeurs
 Pinze per laminectomia

B04

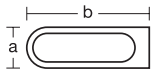





Ferris-Smith

		gerade straight recta droit retta	aufgewinkelt angled upwards angulada hacia arriba coudé en haut angolata verso l'alto	aufgewinkelt angled upwards angulada hacia arriba coudé en haut angolata verso l'alto
Maulbreite Jaw width Ancho de la boca Largeur des mors Larghezza del morso a	Maullänge Jaw length Longitud de la boca Longueur des mors Lunghezza del morso b			
8 mm	16 mm	c = 25 cm – 10"	30° c = 25 cm – 10"	60° c = 25 cm – 10"
		57.15.00	57.15.30	57.15.60

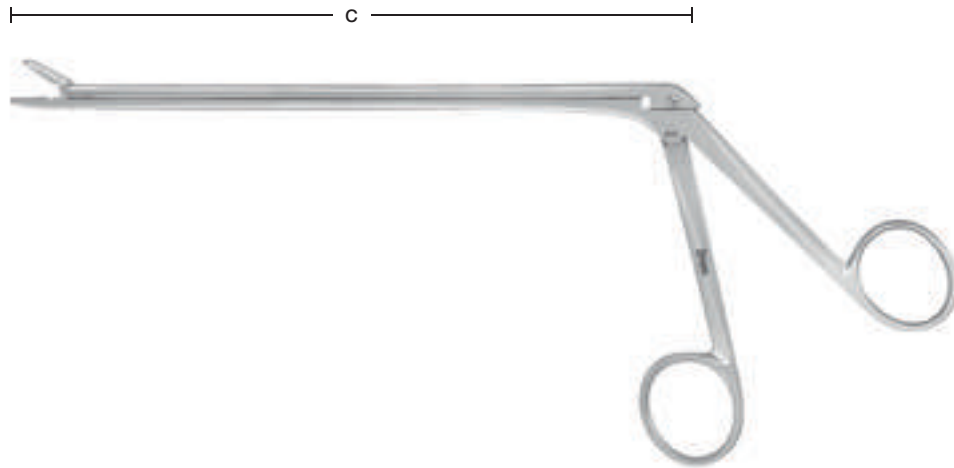
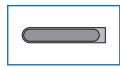
**B04**

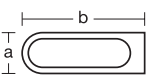
Rongeur
Rongeurs
Pinzas cortantes
Rongeurs
Pinze per laminectomia



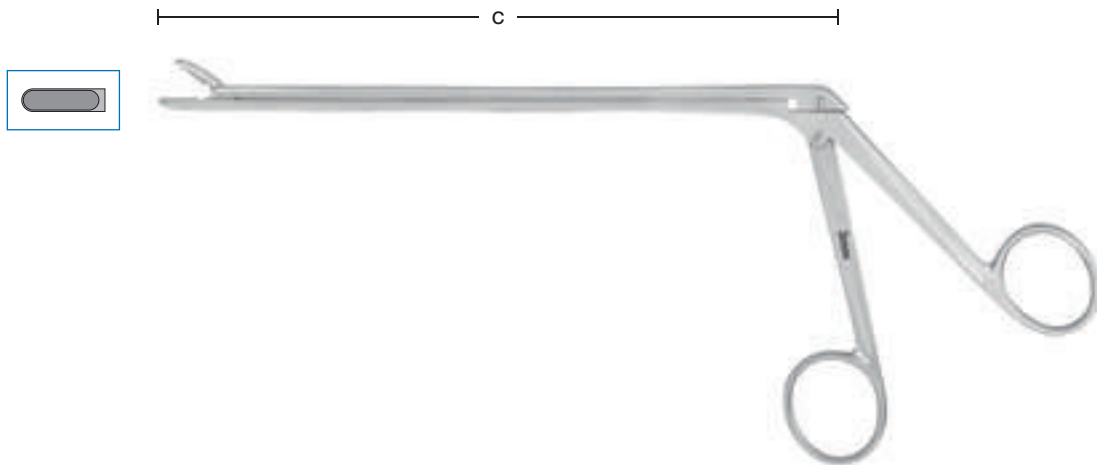

**Cushing**

			gerade straight recta droit retta	aufgewinkelt angled upwards angulada hacia arriba coudé en haut angolata verso l'alto	abgewinkelt angled downwards angulada hacia abajo coudé en bas angolata verso il basso
Maulbreite Jaw width Ancho de la boca Largeur des mors Larghezza del morso	Maullänge Jaw length Longitud de la boca Longueur des mors Lunghezza del morso	c			
a	b			30°	30°
2 mm	10 mm	13 cm – 5 1/8"	57.20.02	57.20.32	57.20.62
2 mm	10 mm	15 cm – 6"	57.20.12	57.20.42	57.20.72
2 mm	10 mm	18 cm – 7 1/8"	57.20.22	57.20.52	57.20.82
2 mm	10 mm	23 cm – 9"	57.20.84	57.20.86	57.20.88
2 mm	10 mm	28 cm – 11"	57.20.90	57.20.92	57.20.94



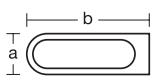

Love-Gruenwald

			gerade straight recta droit retta	aufgewinkelt angled upwards angulada hacia arriba coudé en haut angolata verso l'alto	abgewinkelt angled downwards angulada hacia abajo coudé en bas angolata verso il basso
Maulbreite Jaw width Ancho de la boca Largeur des mors Larghezza del morso	Maullänge Jaw length Longitud de la boca Longueur des mors Lunghezza del morso	c			
a	b			30°	30°
3 mm	10 mm	13 cm – 5 1/8"	57.21.03	57.21.33	57.21.63
3 mm	10 mm	15 cm – 6"	57.21.13	57.21.43	57.21.73
3 mm	10 mm	18 cm – 7 1/8"	57.21.23	57.21.53	57.21.83
3 mm	10 mm	23 cm – 9"	57.21.75	57.21.77	57.21.79
3 mm	10 mm	28 cm – 11"	57.21.85	57.21.87	57.21.89

**B04**

Rongeur
Rongeurs
Pinzas cortantes
Rongeurs
Pinze per laminectomia

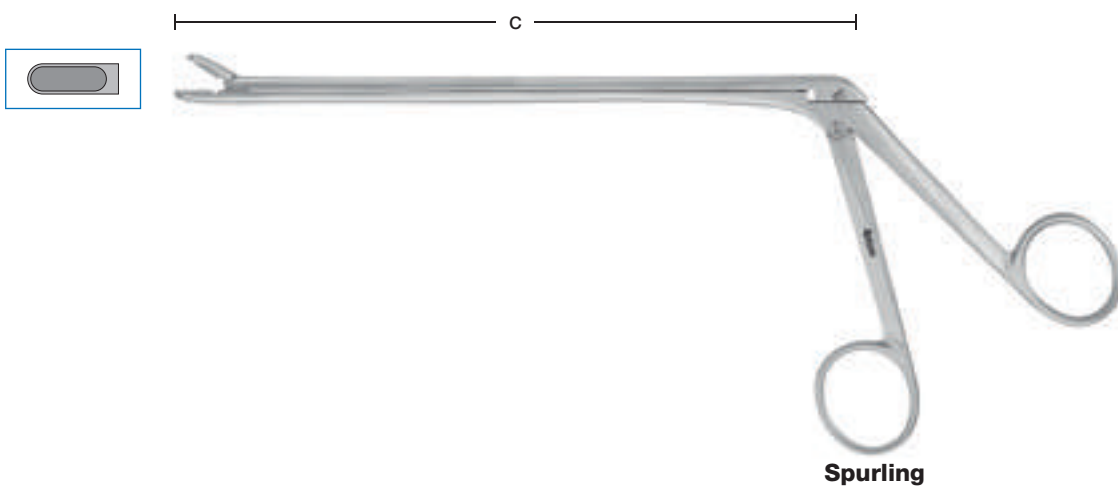
**Spurling**

			gerade straight recta droit retta	aufgewinkelt angled upwards angulada hacia arriba coudé en haut angolata verso l'alto	abgewinkelt angled downwards angulada hacia abajo coudé en bas angolata verso il basso
Maulbreite Jaw width Ancho de la boca Largeur des mors Larghezza del morso	Maullänge Jaw length Longitud de la boca Longueur des mors Lunghezza del morso	c			
a	b			30°	30°
4 mm	10 mm	13 cm - 5 1/8"	57.22.04	57.22.34	57.22.64
4 mm	10 mm	15 cm - 6"	57.22.14	57.22.44	57.22.74
4 mm	10 mm	18 cm - 7 1/8"	57.22.24	57.22.54	57.22.84
4 mm	10 mm	23 cm - 9"	57.22.86	57.22.90	57.22.92
4 mm	10 mm	28 cm - 11"	57.22.93	57.22.94	57.22.95

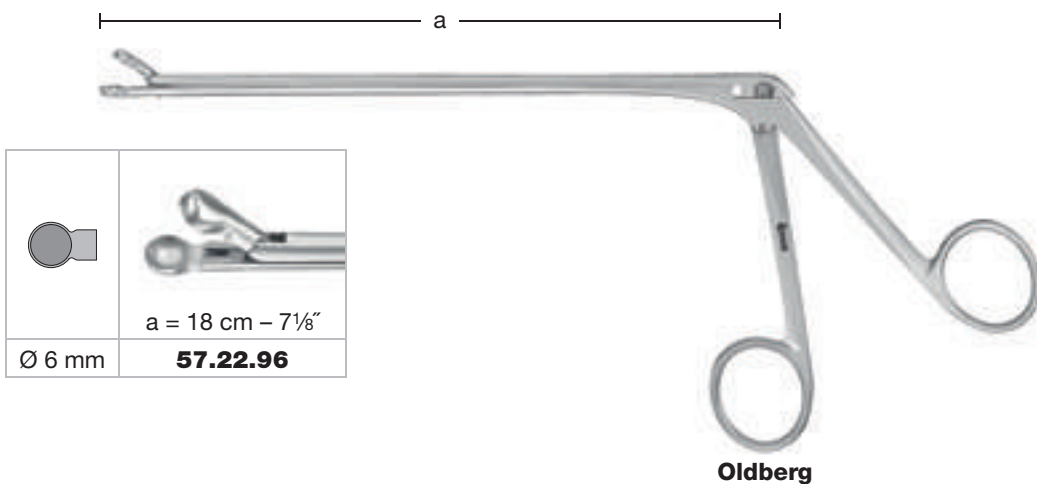
**Oldberg**

Ø 6 mm

a = 18 cm - 7 1/8"

57.22.96

Rongeur
Rongeurs
Pinzas cortantes
Rongeurs
Pinze per laminectomia

B04

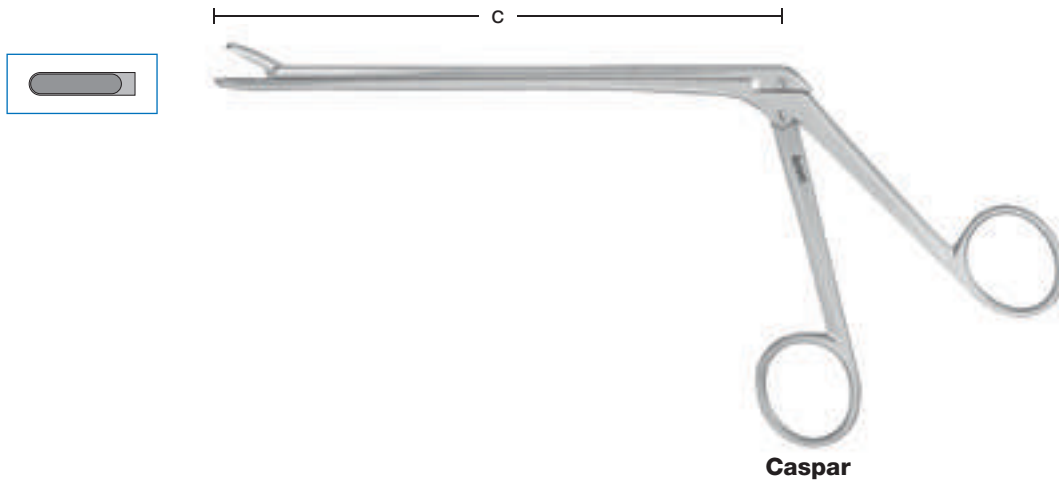

Caspar

		gerade straight recta droit retta	aufgewinkelt angled upwards angulada hacia arriba coudé en haut angolata verso l'alto	abgewinkelt angled downwards angulada hacia abajo coudé en bas angolata verso il basso
Maulbreite Jaw width Ancho de la boca Largeur des mors Larghezza del morso a	Maullänge Jaw length Longitud de la boca Longueur des mors Lunghezza del morso b	 c = 15,5 cm – 6 1/8"	 30° c = 15,5 cm – 6 1/8"	 30° c = 15,5 cm – 6 1/8"
2 mm	14 mm	57.23.02	57.23.12	57.23.22
3 mm	14 mm	57.23.03	57.23.13	57.23.23
4 mm	14 mm	57.23.04	57.23.14	57.23.24
5 mm	14 mm	57.23.05		





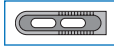

**B04**

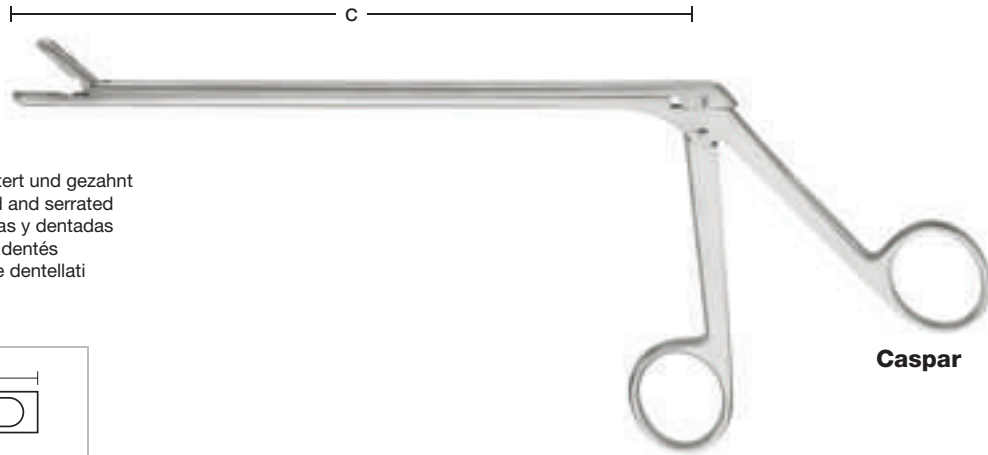
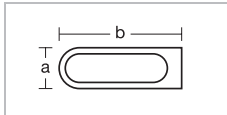
Rongeur
Rongeurs
Pinzas cortantes
Rongeurs
Pinze per laminectomia



Maulteile gefenestert und gezahnt
 Jaws fenestrated and serrated
 Bocas fenestradas y dentadas
 Mors fenêtrés et dentés
 Morsi fenestrati e dentellati

**Caspar**

Maulbreite Jaw width Ancho de la boca Largeur des mors Larghezza del morso a	Maullänge Jaw length Longitud de la boca Longueur des mors Lunghezza del morso b	gerade straight recta droit retta c = 14 cm – 5½"	 c = 16 cm – 6¼"	 c = 18,5 cm – 7¼"
2 mm	12 mm	57.23.27	57.23.32	57.23.62
3 mm	12 mm	57.23.28	57.23.33	57.23.63
4 mm	14 mm	57.23.29	57.23.34	57.23.64
5 mm	14 mm		57.23.35	57.23.65
6 mm	16 mm		57.23.36	57.23.66
Maulbreite Jaw width Ancho de la boca Largeur des mors Larghezza del morso a	Maullänge Jaw length Longitud de la boca Longueur des mors Lunghezza del morso b	aufgewinkelt angled upwards angulada hacia arriba coudé en haut angolata verso l'alto 30° c = 14 cm – 5½"	 30° c = 16 cm – 6¼"	 30° c = 18,5 cm – 7¼"
3 mm	12 mm	57.23.40	57.23.43	57.23.73
4 mm	14 mm	57.23.41	57.23.44	57.23.74
5 mm	14 mm		57.23.45	57.23.75
Maulbreite Jaw width Ancho de la boca Largeur des mors Larghezza del morso a	Maullänge Jaw length Longitud de la boca Longueur des mors Lunghezza del morso b	abgewinkelt angled downwards angulada hacia abajo coudé en bas angolata verso il basso 30° c = 14 cm – 5½"	 30° c = 16 cm – 6¼"	 30° c = 18,5 cm – 7¼"
3 mm	12 mm	57.23.51	57.23.53	57.23.83
4 mm	14 mm	57.23.52	57.23.54	57.23.84



		gerade straight recta droit retta
Maulbreite Jaw width Ancho de la boca Largeur des mors Larghezza del morso a	Maullänge Jaw length Longitud de la boca Longueur des mors Lunghezza del morso b	
4 mm	8 mm	c = 18 cm - 7 1/8" 57.23.87

Caspar

		gerade straight recta droit retta
Maulbreite Jaw width Ancho de la boca Largeur des mors Larghezza del morso a	Maullänge Jaw length Longitud de la boca Longueur des mors Lunghezza del morso b	
5,5 mm	10 mm	c = 20 cm - 8" 57.23.90

Wagner

**B04**

Rongeur
Rongeurs
Pinzas cortantes
Rongeurs
Pinze per laminectomia

21
8
20
19
7
18
17
16
6
15
14
5
13
12
11
4
10
9
3
8
7
6
2
5
4
3
1
2
1
1
cm
inch

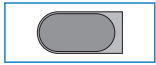

		gerade straight recta droit retta
Maulbreite Jaw width Ancho de la boca Largeur des mors Larghezza del morso a	Maullänge Jaw length Longitud de la boca Longueur des mors Lunghezza del morso b	
5,5 mm	10 mm	c = 21 cm - 8 1/4" 57.23.91

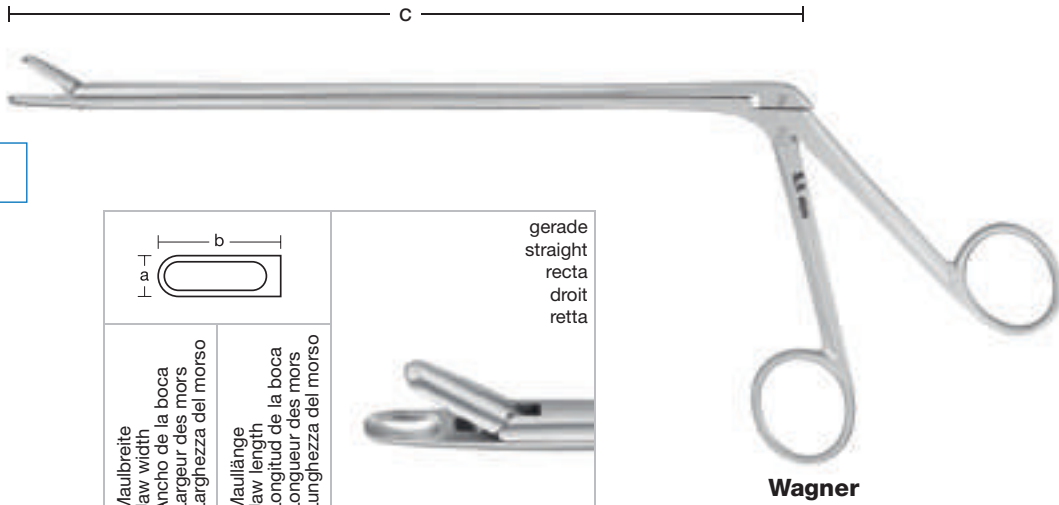
**Wagner**

		aufgewinkelt angled upwards angulada hacia arriba coudé en haut angolata verso l'alto
Maulbreite Jaw width Ancho de la boca Largeur des mors Larghezza del morso a	Maullänge Jaw length Longitud de la boca Longueur des mors Lunghezza del morso b	
5,8 mm	14 mm	30° c = 25,5 cm - 10" 57.23.93

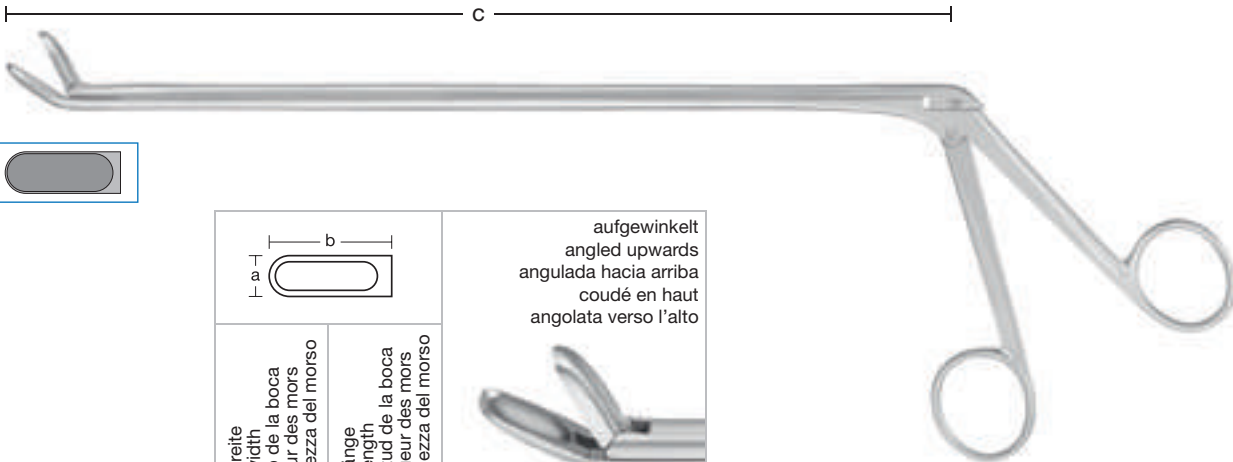
**Sypert**

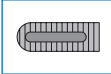
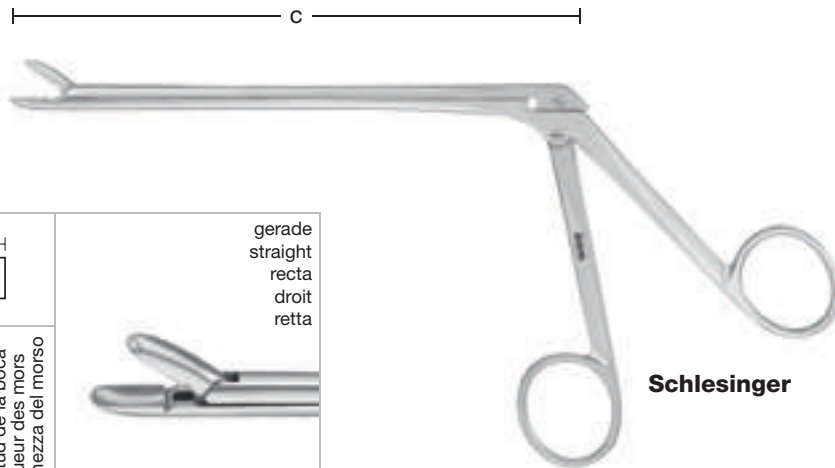
		gerade straight recta droit retta
Maulbreite Jaw width Ancho de la boca Largeur des mors Larghezza del morso a	Maullänge Jaw length Longitud de la boca Longueur des mors Lunghezza del morso b	c = 15 cm - 6"
2 mm	10 mm	57.24.32
3 mm	10 mm	57.24.33
4 mm	10 mm	57.24.34

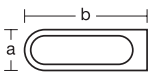
Schlesinger



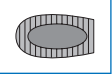
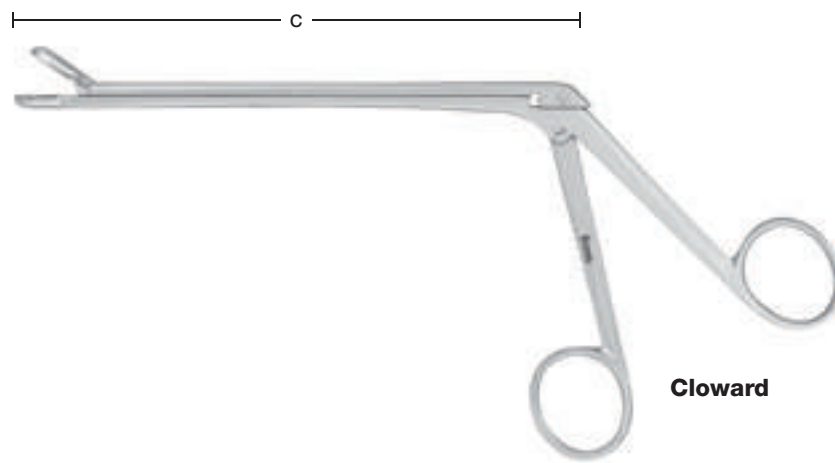

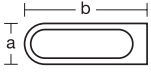
		gerade straight recta droit retta	aufgewinkelt angled upwards angulada hacia arriba coudé en haut angolata verso l'alto	abgewinkelt angled downwards angulada hacia abajo coudé en bas angolata verso il basso
Maulbreite Jaw width Ancho de la boca Largeur des mors Larghezza del morso a	Maullänge Jaw length Longitud de la boca Longueur des mors Lunghezza del morso b	c = 15 cm - 6"	30° c = 15 cm - 6"	30° c = 15 cm - 6"
6 mm	10 mm	57.24.40	57.24.43	57.24.45

Cloward

**B04**

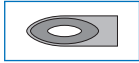
Rongeur
Rongeurs
Pinzas cortantes
Rongeurs
Pinze per laminectomia



Maulteile gefenstert
 Jaws fenestrated
 Bocas fenestradas
 Mors fenêtrés
 Morsi fenestrati

Maulbreite Jaw width Ancho de la boca Largeur des mors Larghezza del morso		Maullänge Jaw length Longitud de la boca Longueur des mors Lunghezza del morso		gerade straight recta droit retta	
a	b	c = 13 cm - 5 1/8"	c = 17 cm - 6 3/4"		
3 mm	8 mm	57.24.61	57.24.71		
4 mm	10 mm	57.24.62	57.24.72		
5 mm	12 mm	57.24.63	57.24.73		

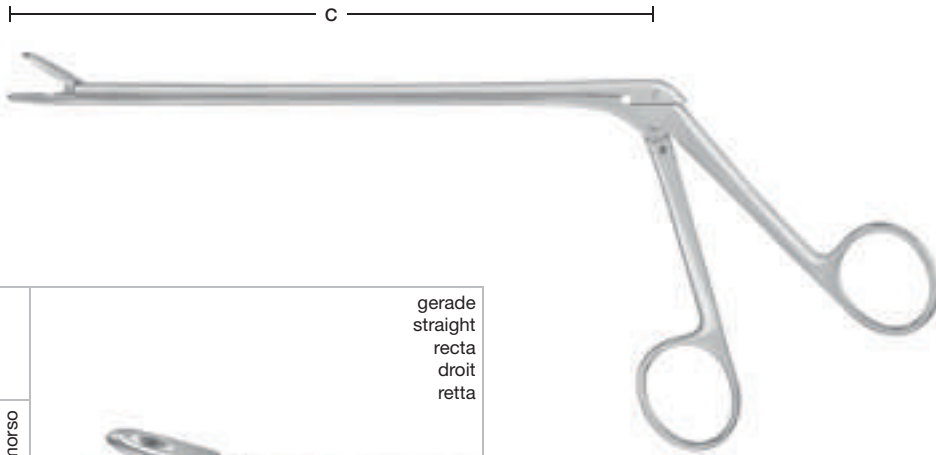
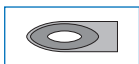
**Wilde**

Maulteile gefenstert
 Jaws fenestrated
 Bocas fenestradas
 Mors fenêtrés
 Morsi fenestrati

Maulbreite Jaw width Ancho de la boca Largeur des mors Larghezza del morso		Maullänge Jaw length Longitud de la boca Longueur des mors Lunghezza del morso		aufgewinkelt angled upwards angulada hacia arriba coudé en haut angolata verso l'alto	
a	b	45° c = 13 cm - 5 1/8"	45° c = 17 cm - 6 3/4"		
3 mm	8 mm	57.24.66	57.24.76		
4 mm	10 mm	57.24.67	57.24.77		
5 mm	12 mm	57.24.68	57.24.78		

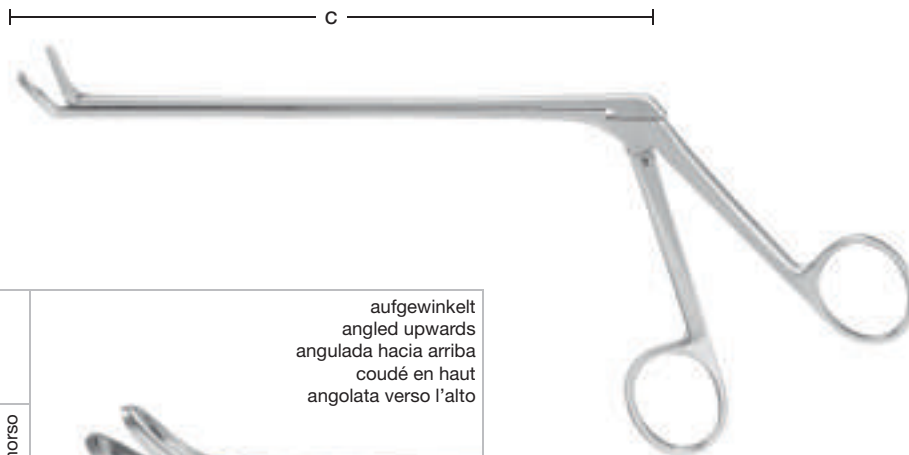
**Wilde**

Haken und Dissektoren
Hooks and Dissectors
Ganchos y disectores
Crochets et dissecteurs
Uncini e dissectori

B05

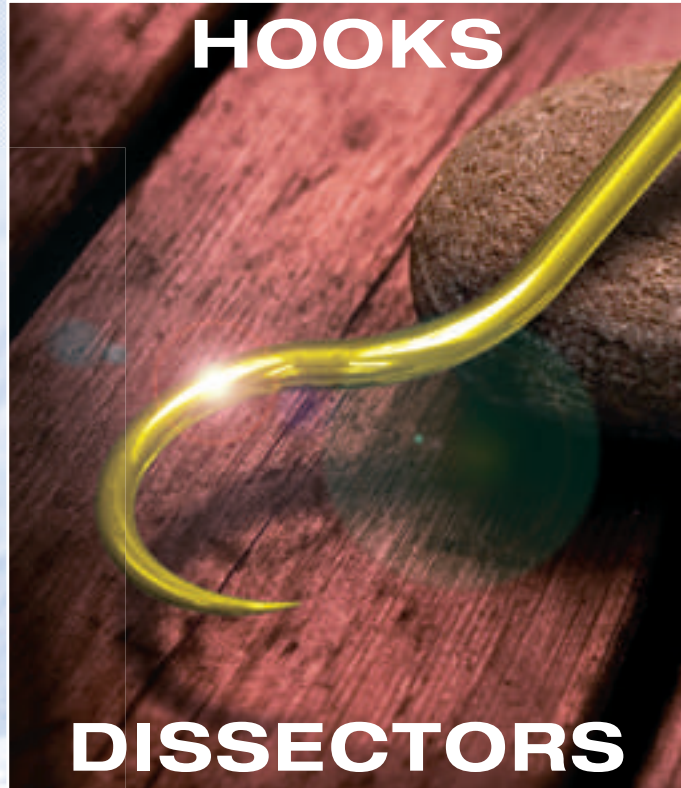



B05

Haken
Hooks
Ganchos
Crochets
Uncini



Nervhäkchen
Nerve hooks
Ganchitos para nervios
Crochets à nerfs
Uncini per nervi



7 mm



9 mm



16 cm – 6¼"
20.20.57

16 cm – 6¼"
20.20.59



4 mm

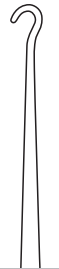

16 cm – 6¼"
20.20.34



2 mm



3 mm



4 mm



14 cm – 5½"
20.22.01

14 cm – 5½"
20.22.02

14 cm – 5½"
20.22.03

Lucae

Nervhäkchen
Nerve hooks
Ganchitos para nervios
Crochets à nerfs
Uncini per nervi

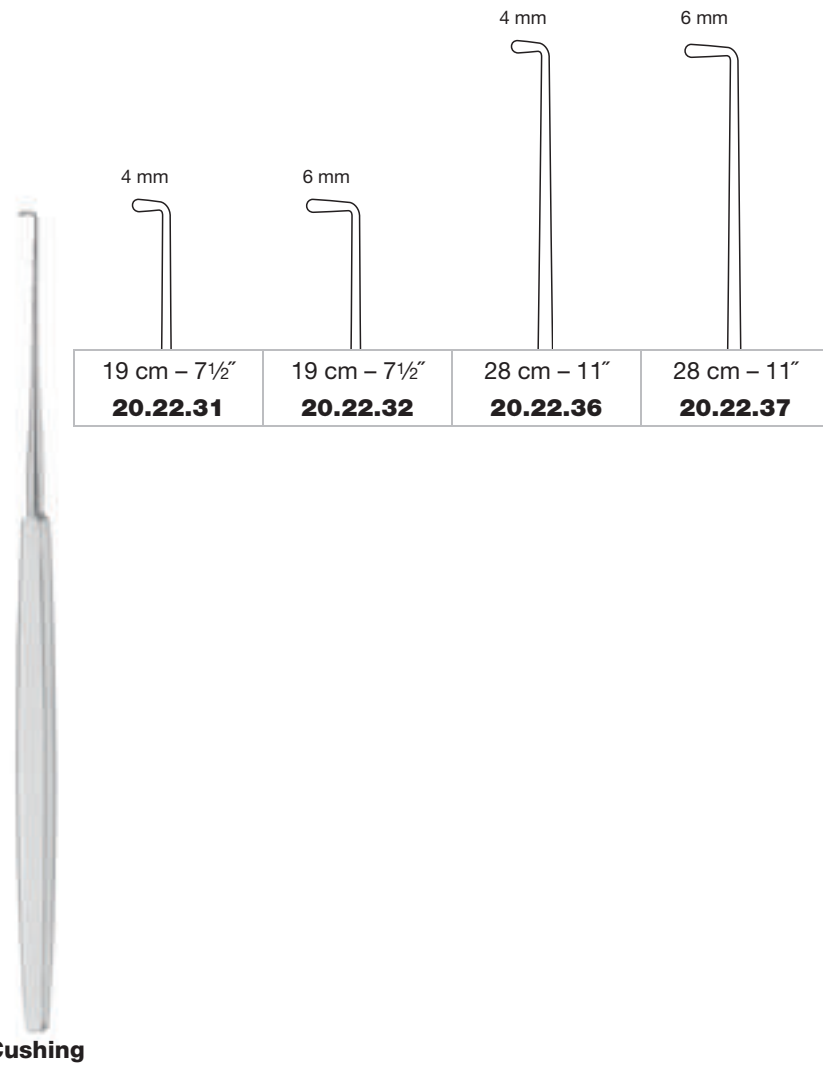



**Haken
Hooks
Ganchos
Crochets
Uncini**

B05



2 mm

5 mm

8 mm

19 cm - 7½"

19 cm - 7½"

19 cm - 7½"

57.49.19

57.49.20

57.49.21



3 mm

4 mm

5 mm

a = 130 mm

a = 130 mm

a = 130 mm

24 cm - 9½"

24 cm - 9½"

24 cm - 9½"

57.50.24

57.50.25

57.50.26

Nervhäkchen
Nerve hooks
Ganchitos para nervios
Crochets à nerfs
Uncini per nervi

Nerv- und Gefäßhäkchen
Nerve and vessel hooks
Ganchitos para nervios y vasos
Crochets à nerfs et vaisseaux
Uncini per nervi e vasi



mit scharfer Schneide
with sharp cutting edge
con corte afilado
avec tranchant aigu
con tagliente affilato



Eif

2,0 mm



24 cm – 9½”
57.49.10

3,0 mm



18,5 cm – 7¼”
58.30.31

3,5 mm



18,5 cm – 7¼”
58.30.32

2,0 mm



18,5 cm – 7¼”
58.30.35

2,5 mm



18,5 cm – 7¼”
58.30.36



Krayenbühl



Vergrößerung
Magnification
Engrandecimiento
Agrandissement
Ingrandimento



**Haken
Hooks
Ganchos
Crochets
Uncini**

B05

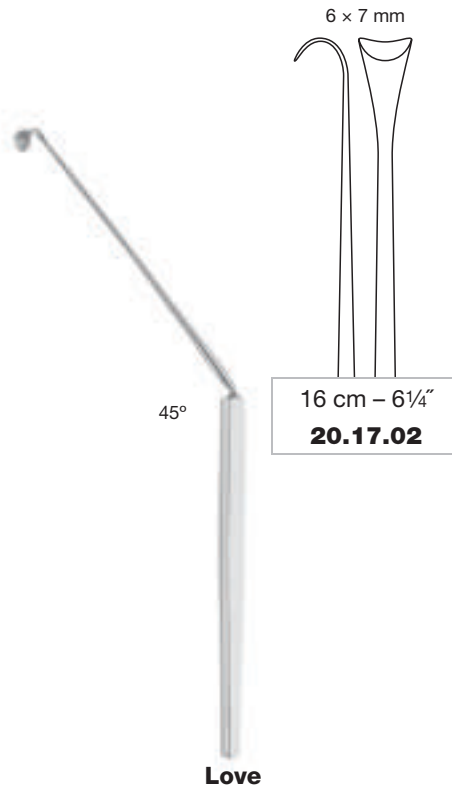
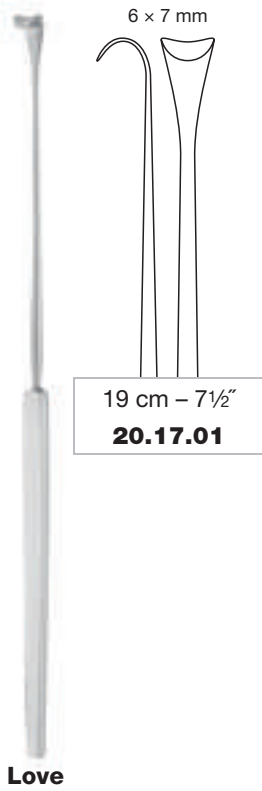

Nervwurzelhaken
Nerve root retractors
Separadores para raíz nerviosa
Ecarteurs à racines nerveuses
Uncini per radici nervose

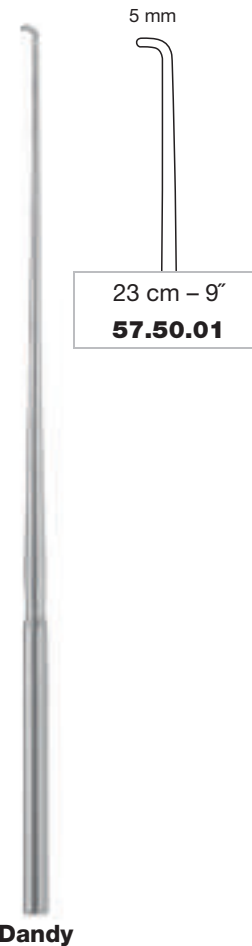
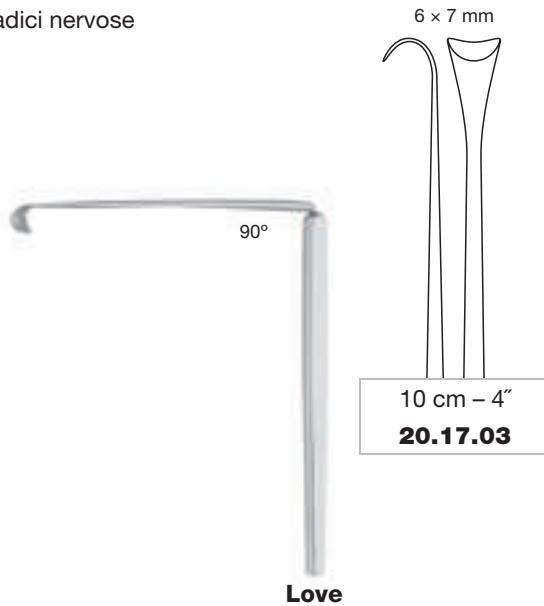



Nervwurzelhaken
Nerve root retractors
Separadores para raíz nerviosa
Ecarteurs à racines nerveuses
Uncini per radici nervose

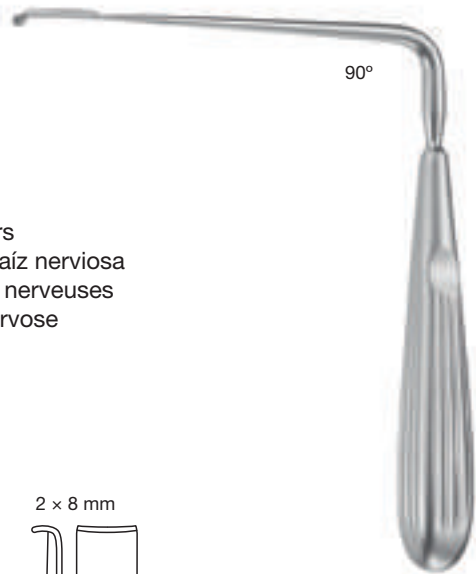

90°

2 x 8 mm



14,5 cm - 5¾"
57.50.51

Scoville



2 x 8 mm



26 cm - 10¼"
57.50.50

Scoville

4 x 4 mm

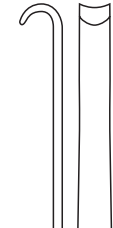

21 cm - 8¼"
57.50.60

Love



Blatt, gewölbt
Blade, curved
Hoja, abovedada
Lame, courbée
Valva, convessa

**B05**

Haken
Hooks
Ganchos
Crochets
Uncini

Nervwurzelhaken
 Nerve root retractors
 Separadores para raíz nerviosa
 Ecarteurs à racines nerveuses
 Uncini per radici nervose

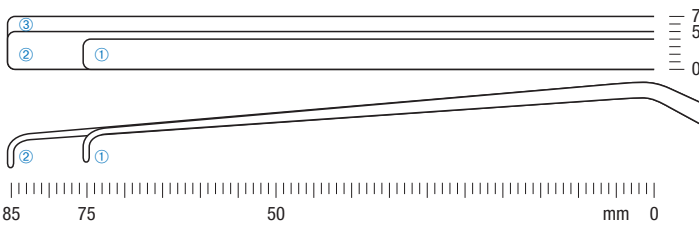

①	a = 75 mm	b = 4 mm	18 cm - 7 1/8"	57.50.64
②	a = 85 mm	b = 5 mm	18 cm - 7 1/8"	57.50.65
③	a = 85 mm	b = 7 mm	18 cm - 7 1/8"	57.50.67

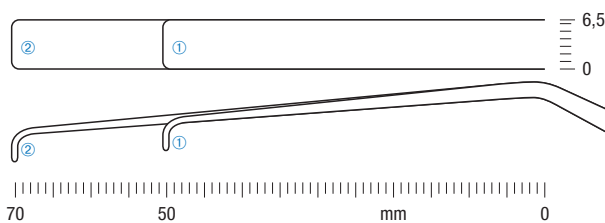
**Love**

①	a = 50 mm	b = 6,5 mm	18 cm - 7 1/8"	57.50.68
②	a = 70 mm	b = 6,5 mm	18 cm - 7 1/8"	57.50.70

**Love-Papavero**

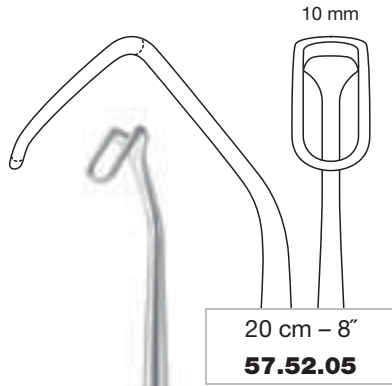

Dekompressionshaken
Decompression retractor
Separador para decompresión
Ecarteur décompresseur
Divaricatore per decompressione

Cushing



Caspar

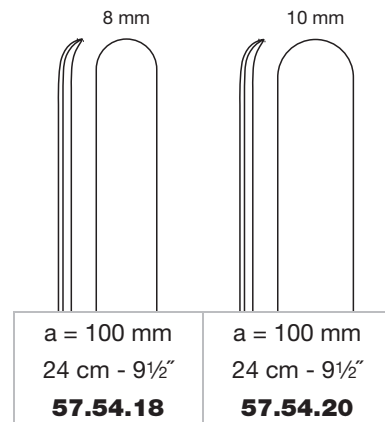
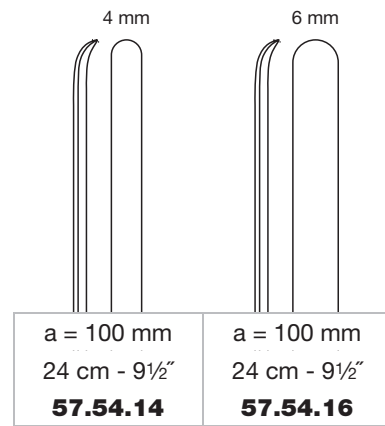

Nervwurzelnhaken für lumbale Mikrodissektomie
Nerve root retractors for micro lumbar discectomy
Separadores para raíz nerviosa para la microdissectomía lumbar
Ecarteurs à racines nerveuses pour la microdissectomie lombaire
Uncini per radici nervose per la microdissectomia lombare



B05

- Haken**
- Hooks**
- Ganchos**
- Crochets**
- Uncini**

Wundhaken mit Kaltlichtbeleuchtung
 Retractor with fibre optic illumination
 Separador con iluminación de luz fría
 Ecarteur avec illumination à lumière froide
 Divaricatore con illuminazione a luce fredda

inklusive Adapter zum Anschluß für Lichtleitkabel
 including adapter for connection to fibre optic cable
 incluyendo el adaptador para la conexión del cable fibra óptica
 avec adaptateur pour la connexion du câble de fibre optique
 compreso l'adattatore per la connessione di cavo a fibro ottica

ACMI · MEDICON · WOLF · STORZ

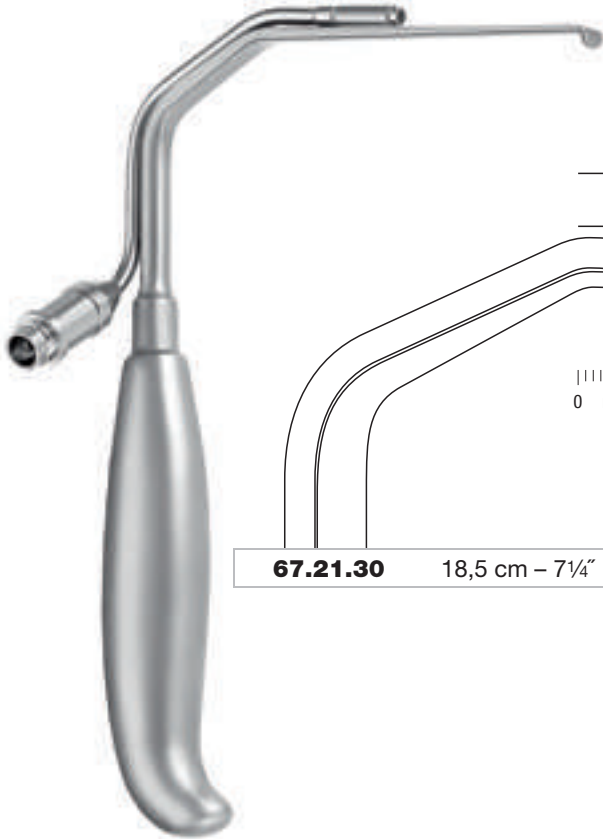

Walter

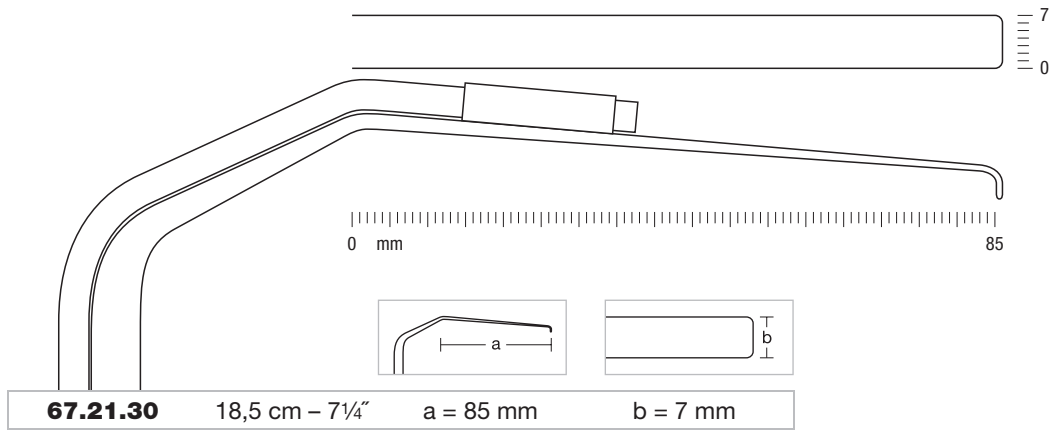

67.21.30	18,5 cm – 7 1/4"	a = 85 mm	b = 7 mm
-----------------	------------------	-----------	----------

Häkchen
Hooks
Ganchos
Crochets
Uncini

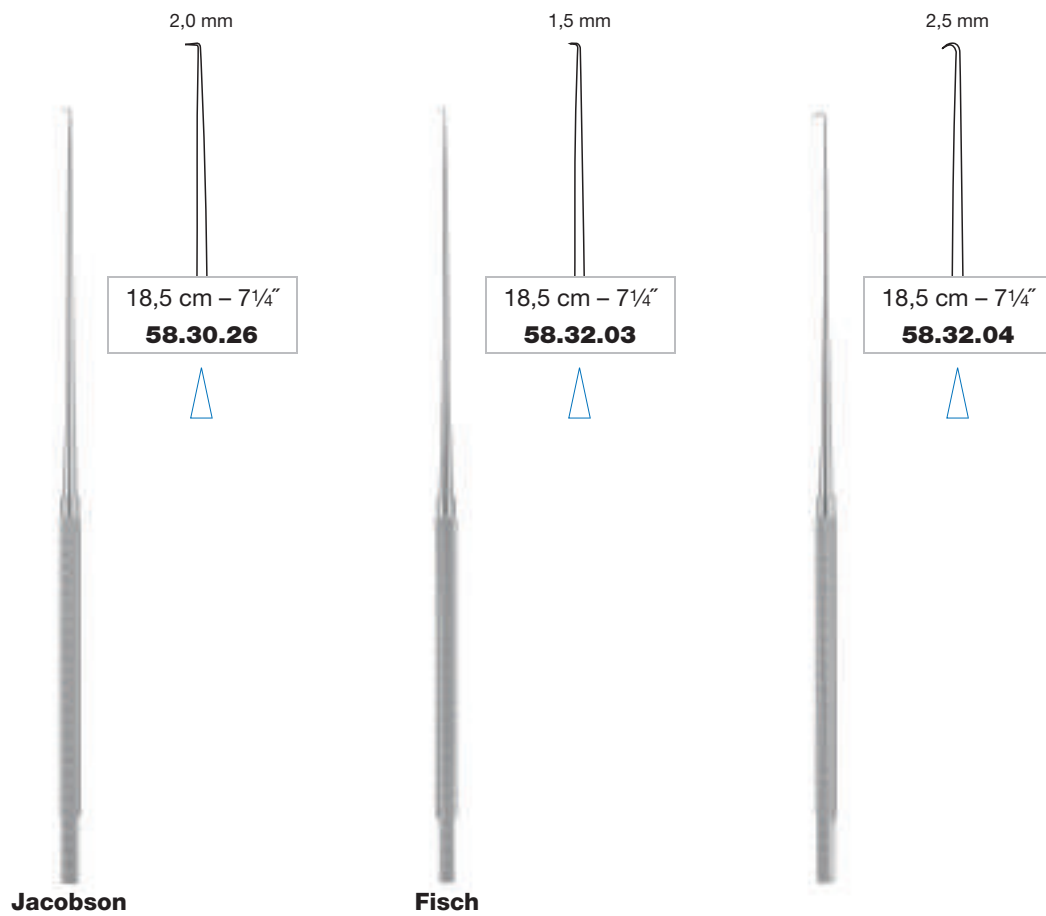



B05

Haken
Hooks
Ganchos
Crochets
Uncini



Häkchen
Hooks
Ganchos
Crochets
Uncini

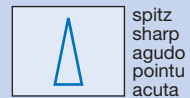
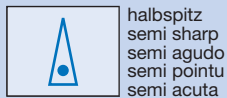
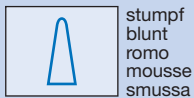
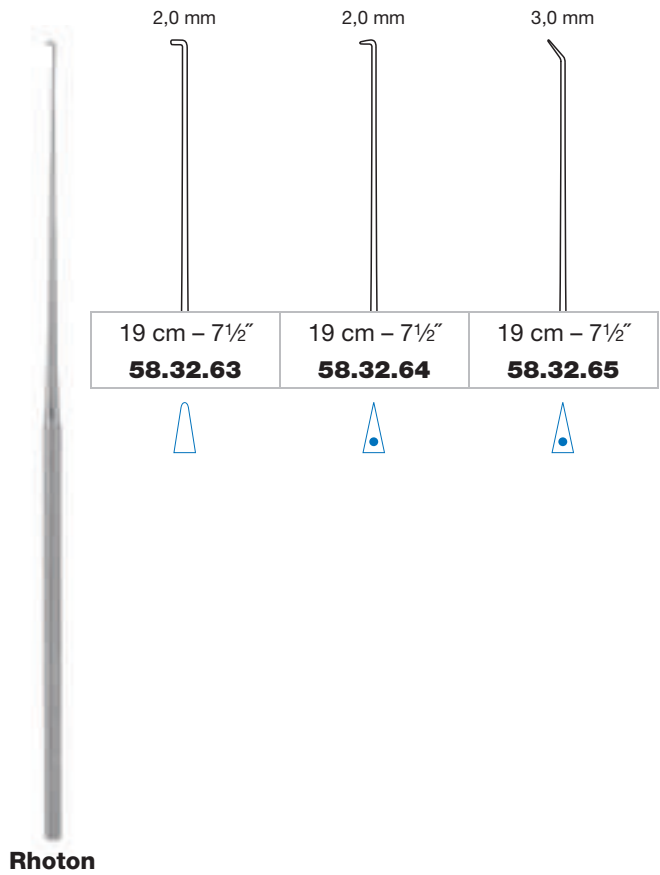
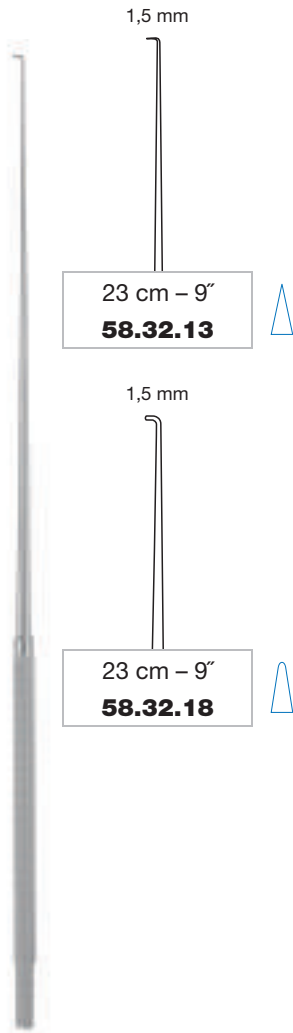

Dura- und Hauthäkchen
Dura and skin hooks
Ganchitos para duramadre y piel
Crochets pour dure-mère et peau
Uncini per dura-madre e pelle

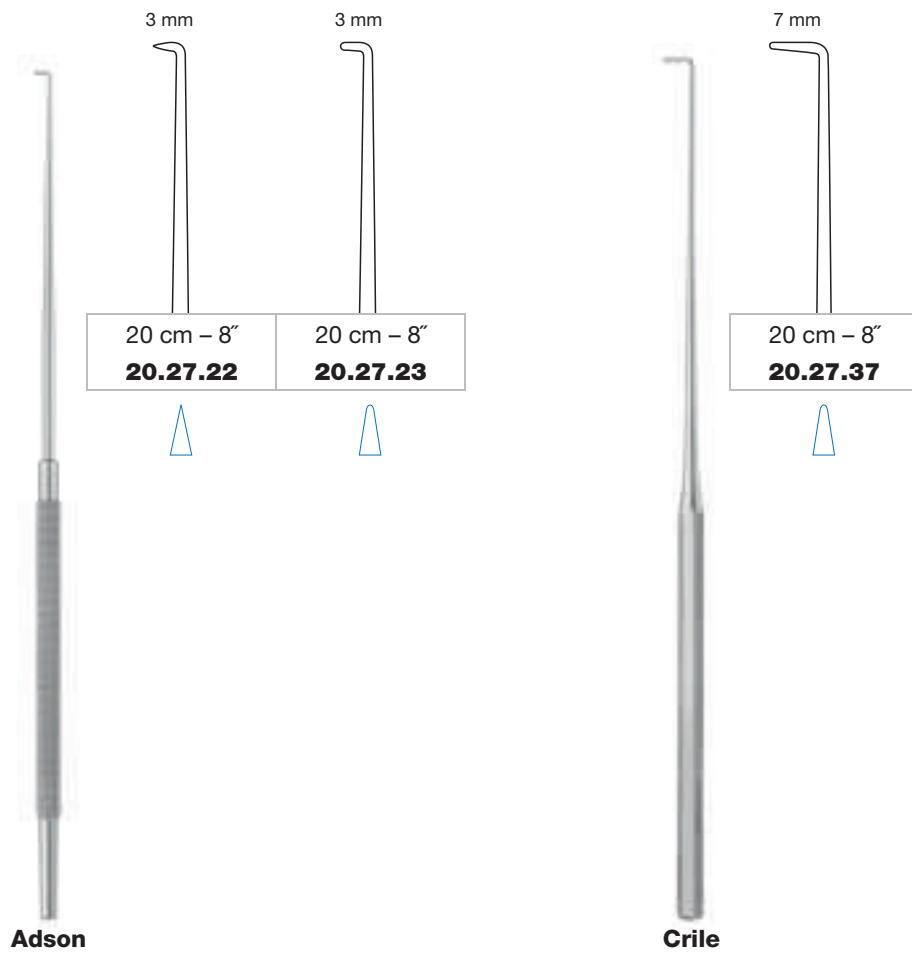

spitz
sharp
agudo
pointu
acuta



stumpf
blunt
romo
mousse
smussa



Haken
Hooks
Ganchos
Crochets
Uncini

B05



Dura- und Hauthäkchen
Dura and skin hooks
Ganchitos para duramadre y piel
Crochets pour dure-mère et peau
Uncini per dura-madre e pelle



3 mm

5 mm



19 cm - 7½"

20.30.19

19 cm - 7½"

20.30.20



Gillies



3 mm



13 cm - 5⅛"

20.30.12



Frazier



3 mm



13 cm - 5⅛"

20.31.13



Straight



1 mm



13 cm - 5⅛"

20.31.15



Lahey-Clinic



spitz
sharp
agudo
pointu
acuta

Sympathektomie-Haken
Sympathectomy hook
Gancho simpatectomia
Crochet sympathectome
Uncino per simpatectomia

Explorationshäkchen
Exploration hooks
Ganchitos para exploración
Crochets pour exploration
Uncini per esplorazione

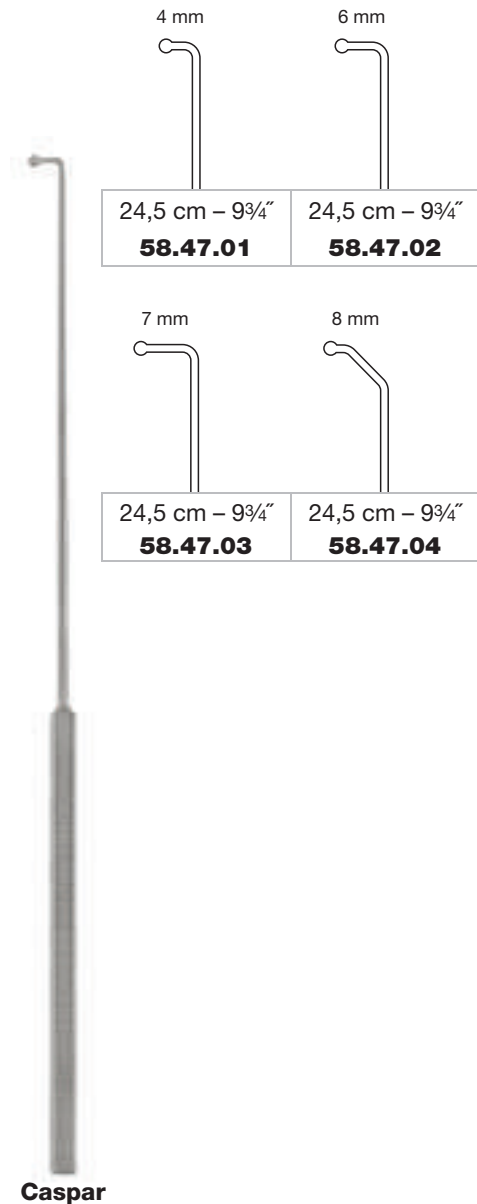
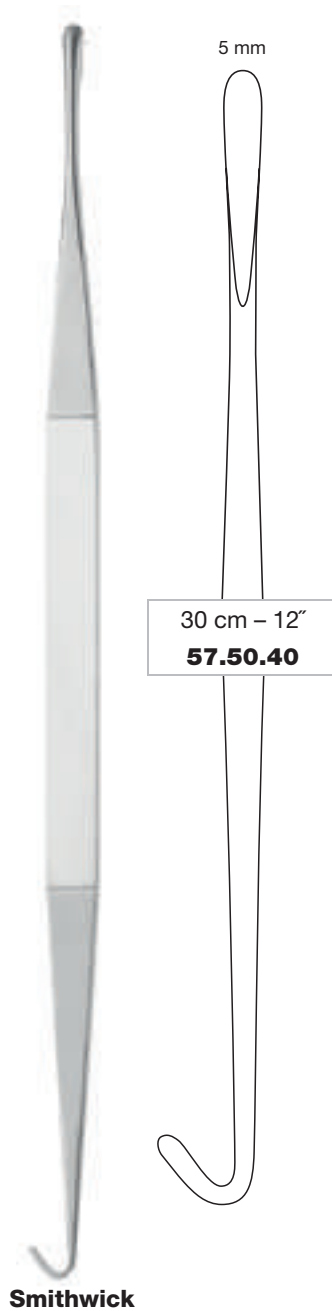

**B05**

Haken
Hooks
Ganchos
Crochets
Uncini

Uvula Spatel
 Uvula spatula
 Espátulas para uvula
 Spatules uvulaire
 Spatole ugola

- ▶ zum Beiseitehalten der Uvula bei transoralem Zugang
- ▶ to hold the uvula aside for transoral approach
- ▶ para mantener al lado la uvula en accesos transorales
- ▶ pour écarter l'uvule en cas d'accès transoral
- ▶ per scostare l'ugola durante un accesso transorale

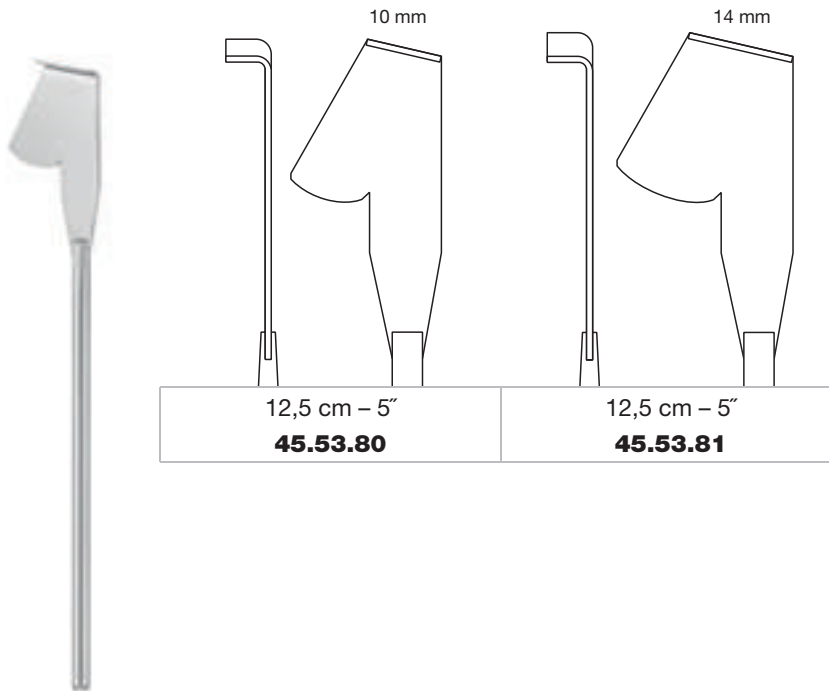

Mit dem besonderen Design kann ein sonst verwendeter zweiter Uvula-Spatel eingespart werden.
 The special design makes the use of an otherwise required second uvula spatula unnecessary.
 Gracias a su diseño especial, el uso de una segunda espátula para uvula no es necesario.
 Son design particulier permet d'éviter l'utilisation complémentaire d'une seconde spatule uvulaire.
 Grazie an design speciale si può evitare l'uso di una seconda spatola per ugola.

Wirbelkörperdissektoren
Vertebral body dissectors
Disectores cuerpo vertebrales
Dissecteurs corps vertébrales
Dissettori corpo vertebrali

- ▶ zum Lösen des posterioren Längsbandes
- ▶ zum Entfernen von Bandscheibenfragmenten und Osteophyten
- ▶ for detaching the posterior longitudinal ligament
- ▶ for removing intervertebral disc fragments and osteophytes
- ▶ para liberar el ligamento longitudinal posterior
- ▶ para eliminar los fragmentos de disco intervertebrales y osteofitos
- ▶ permet de décoller le ligament longitudinal postérieur
- ▶ permet de retirer les fragments de disques intervertébraux et d'ostéophytes
- ▶ per lo scollamento del legamento longitudinale posteriore
- ▶ per rimuovere frammenti di dischi intervertebrali e osteofiti

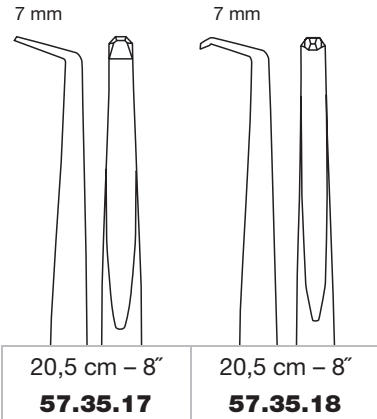

Caspar

Dissektor
Dissector
Disector
Dissecteur
Dissetto

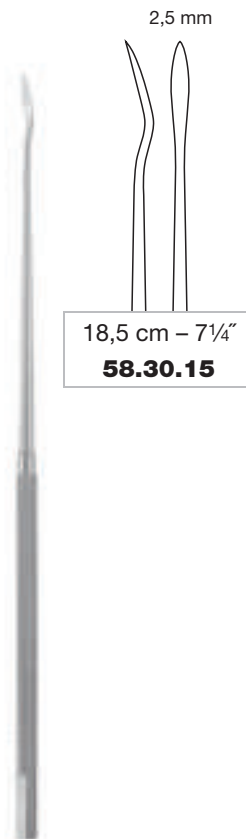

Yasargil



Kunststoffgriff (autoklavierbar bis 134 °C bei 3 bar)
Plastic handle (autoclavable up to 134 °C at 3 bar)
Mango de plástico (autoclavable hasta 134 °C bajo presión de 3 bar)
Manche en plastique (autoclavable à 134 °C sous pression de 3 bars)
Manico di plastica (autoclavabile fino a 134 °C sotto pressione di 3 bar)



Dissektoren
Dissectors
Disectores
Dissecteurs
Dissettori

B05



1,0 mm



23 cm - 9"
58.32.21



1,4 mm



23 cm - 9"
58.32.22



1,8 mm



23 cm - 9"
58.32.23



1,0 mm

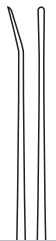

19 cm - 7½"
58.32.57

1,5 mm



19 cm - 7½"
58.32.58

2,8 mm



19 cm - 7½"
58.32.61

2,0 mm

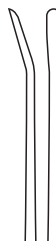

19 cm - 7½"
58.32.59

1,2 mm

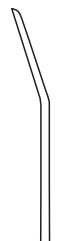

19 cm - 7½"
58.32.60

Rhoton

Rhoton



halbscharf
semi sharp
semi cortante
semi tranchant
semi acuta

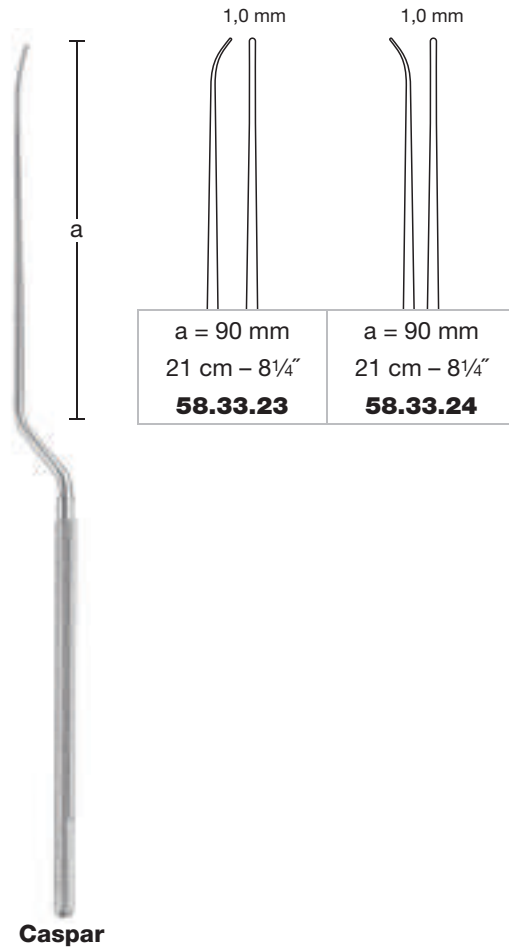



**Dissektoren
Dissectors
Disectores
Dissecteurs
Dissettori**

B05



Caspar

2,0 mm



a = 110 mm
23 cm - 9"
58.33.25

4,5 mm



a = 110 mm
23 cm - 9"
58.33.26

4,5 mm



23 cm - 9"
58.33.27



Caspar

3,0 mm

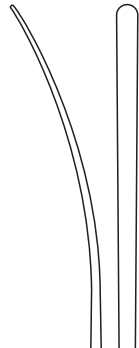

21,5 cm - 8½"
58.36.03

3,0 mm



18,5 cm - 7¼"
58.36.02

Diamantmesser und Mikro-Instrumente
Diamond Knives and Micro Instruments
Cuchillos de diamante y micro instrumentos
Couteaux de diamant et micro instruments
Bisturi diamantati e micro strumenti

B06

Klinge aus Naturdiamant ◀
 Extreme und lang anhaltende Schärfe ◀
 Gute Sichtkontrolle während der Inzision ◀
 Präzise und kraftfreie Schnittführung ◀
 Kein Einreißen des Gewebes während des Schneidens ◀

Blade made of natural diamond ◀
 Extreme and long lasting sharpness ◀
 Excellent visual control during incision ◀
 Precise and force-free incision ◀
 No tissue tearing during the incision ◀

Hoja de diamante natural ◀
 Filo extraordinario y constante ◀
 Buen control de la visión durante la incisión ◀
 Corte preciso y libre de fuerza ◀
 El tejido no rasga durante el corte ◀

Lame de diamant naturel ◀
 Aiguisage soit exceptionnel et de longue durée ◀
 Bon contrôle visuel pendant l'incision ◀
 Coupe précise et sans effort ◀
 Pas de déchirure du tissu pendant la coupe ◀

Lama di diamante naturale ◀
 Affilatura straordinaria e di lunga durata ◀
 Buon controllo visivo durante l'incisione ◀
 Guida da taglio precisa e senza forza ◀
 Nessun strappo del tessuto durante il taglio ◀



Bajonettverschluss zum Ein- und Ausfahren des Diamantmessers
 Bayonet lock for flexion and extension of the diamond knife
 Cierre en forma bayoneta para inserir y extraer el cuchillo de diamante
 Verrouillage en forme baïonnette pour rentrer et sortir le couteau diamant
 Chiusura a forma di baionetta per ritirare e far uscire il bisturi di diamante

**B06**

Diamantmesser mit geradem Klingenhalter
Diamond Knives with Straight Blade Holder
Cuchillos de diamante con mango recto para hojas
Couteaux de diamant avec porte-lame droit
Bisturi diamantati con portalama retto



mit Spülbohrungen
 with irrigation holes
 con orificios de irrigación
 avec trous de lavage
 con fori di lavaggio

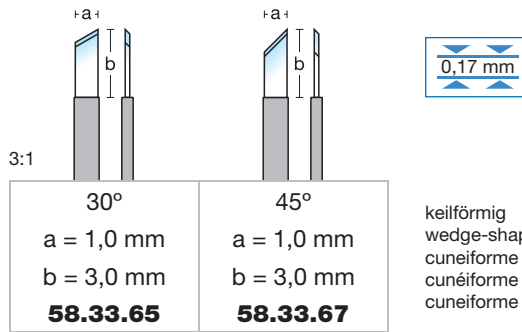

0,17 mm

keilförmig
 wedge-shaped
 cuneiforme
 cunéiforme
 cuneiforme

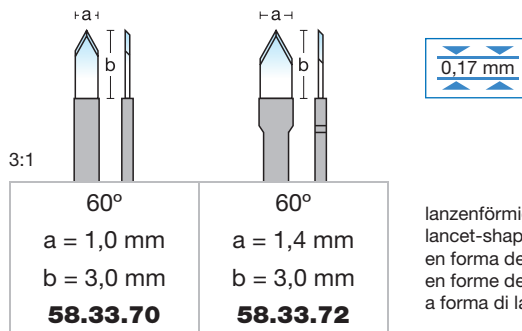

0,17 mm

lanzenförmig
 lancet-shaped
 en forma de lanceta
 en forme de lance
 a forma di lancetta

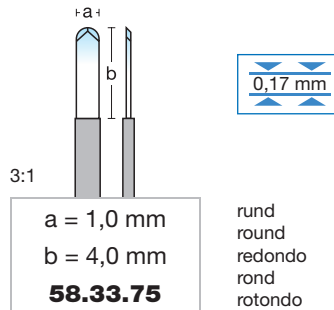

0,17 mm

rund
 round
 redondo
 rond
 rotondo

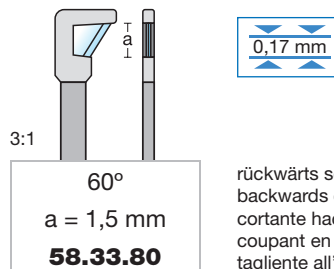

0,17 mm

rückwärts schneidend
 backwards cutting
 cortante hacia atrás
 coupant en arrière
 tagliente all'indietro

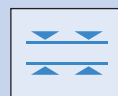

Messerdicke
 Thickness of knives
 Grosor de los cuchillos
 Epaisseur de la lame
 Spessore dei bisturi

Diamantmesser mit gewinkeltem Klingenhalter
Diamond Knives with Angled Blade Holder
Cuchillos de diamante con mango angulado para hojas
Couteaux de diamant avec porte-lame coudé
Bisturi diamantati con portalama angolato

B06

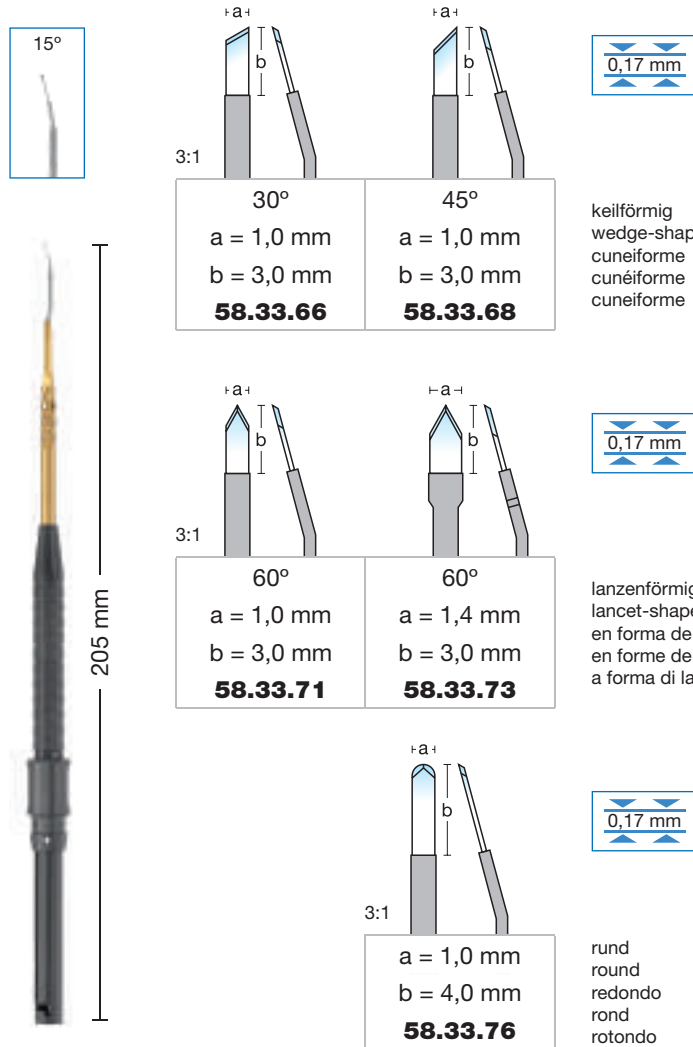

mit Spülbohrungen
with irrigation holes
con orificios de irrigación
avec trous de lavage
con fori di lavaggio

205 mm

Kassette für 12 Instrumente
Tray for 12 instruments
Caja para 12 instrumentos
Cassette pour 12 instruments
Cassetta per 12 strumenti

mit Haltestegen für festen und sicheren Halt
with holding device for a firm and safe storage
con dispositivo de fijación para una sujeción buena y segura
avec dispositif de fixation pour une fixation sûre
con dispositivo di fissazione per un fissaggio sicuro



49.90.04

203 × 114 × 30 mm



Kunststoff (autoklavierbar bis 134 °C bei 3 bar)
Plastic (autoclavable up to 134 °C at 3 bar)
Plástico (autoclavable hasta 134 °C bajo presión de 3 bar)
Plastique (autoclavable à 134 °C sous pression de 3 bars)
Plastica (autoclavabile fino a 134 °C sotto pressione di 3 bar)

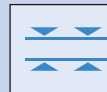

Messerdicke
Thickness of knives
Grosor de los cuchillos
Epaisseur de la lame
Spessore dei bisturi

www.medicon.de

Einen Überblick über das MEDICON-Gesamtprogramm finden Sie im Internet.

For general information on the complete MEDICON product range please refer to the Internet.

Una vista general de la gama completa de productos MEDICON puede encontrar en el Internet.

Pour une vue d'ensemble de la gamme complète des produits MEDICON nous vous prions de bien vouloir vous référer sur notre site Internet.

Una visione generale della completa gamma dei prodotti MEDICON la trovate nell'Internet.



Raspatorien
 Raspatories
 Legras
 Rugines
 Periostotomi

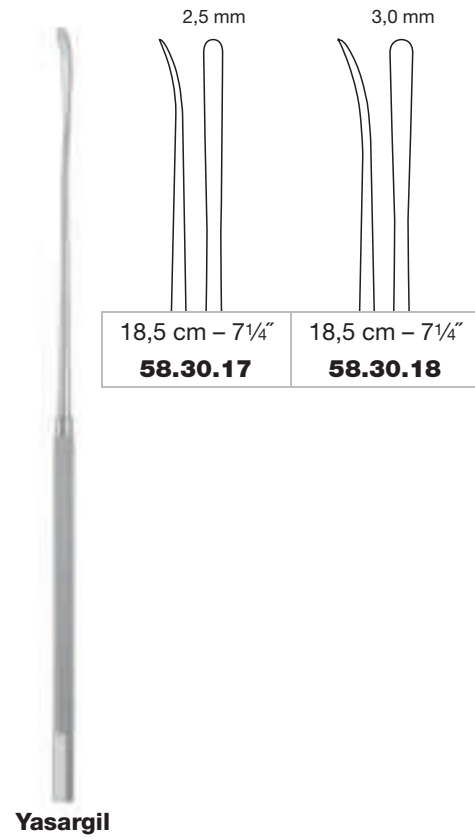
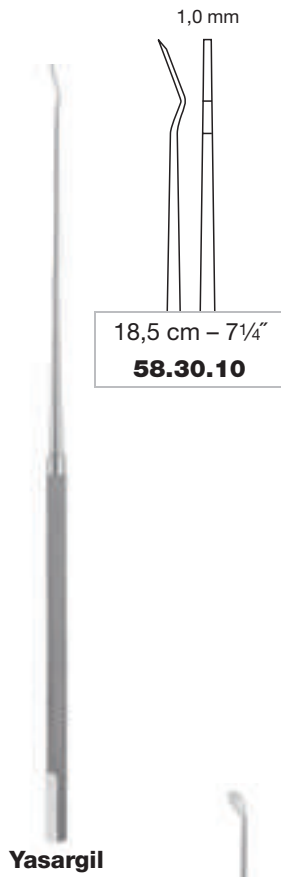



Mikro-Instrumente
Micro Instruments
Micro instrumentos
Micro instruments
Micro strumenti

B06



Raspatorien
Raspatories
Legras
Rugines
Periostotomi

Ø 1,0 mm	Ø 2,0 mm	Ø 3,0 mm
19 cm – 7½"	19 cm – 7½"	19 cm – 7½"
58.32.54	58.32.55	58.32.56

Rhoton

a	2,5 mm
a = 60 mm	
18,5 cm – 7¼"	
58.33.17	

Yasargil

Raspatorien
 Raspatories
 Legras
 Rugines
 Periostotomi

Tumormesser
 Tumor knives
 Cuchillos para tumores
 Couteaux à tumeurs
 Coltelli per tumori

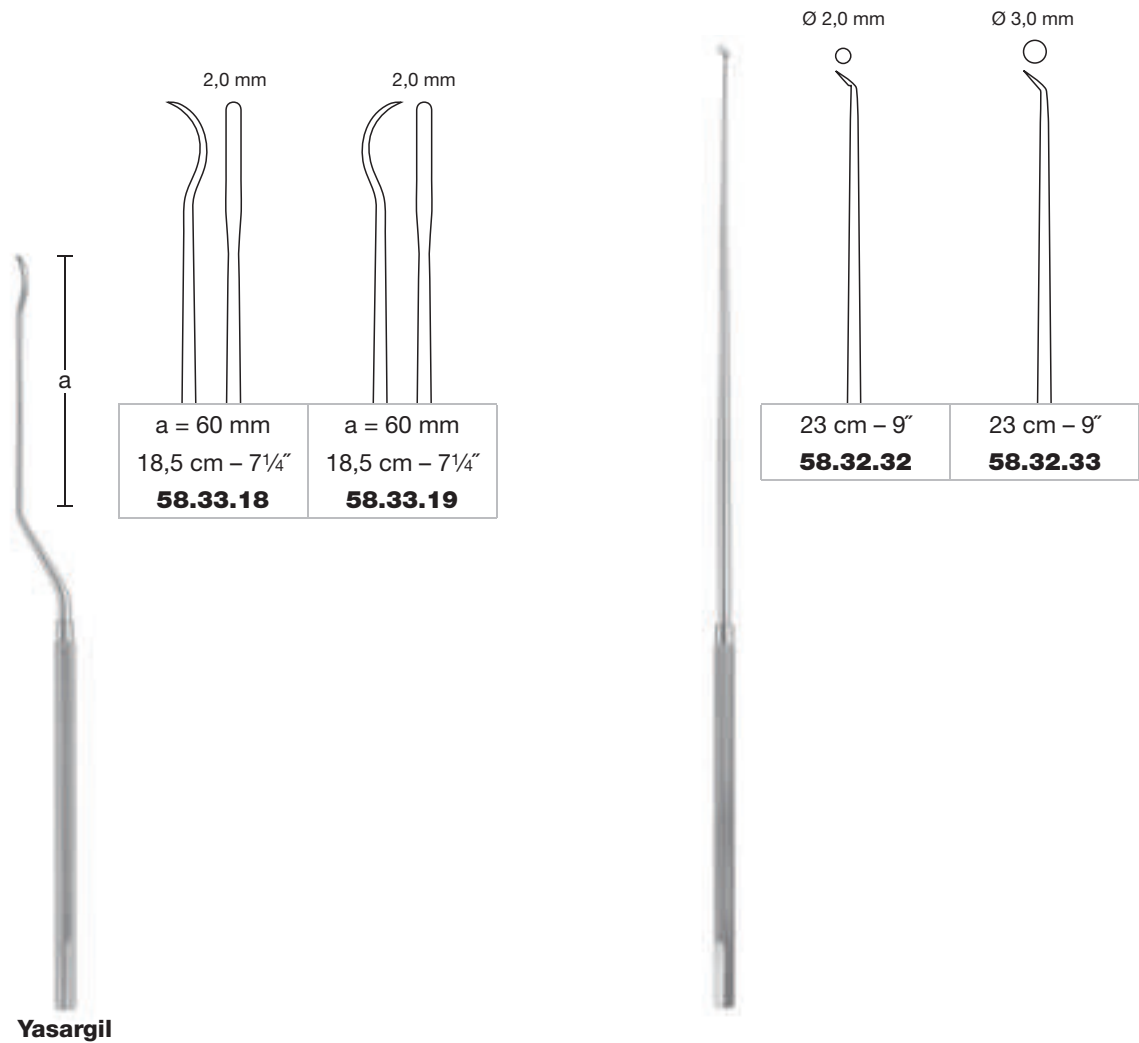

Yasargil

**B06**

Mikro-Instrumente
Micro Instruments
Micro instrumentos
Micro instruments
Micro strumenti



Tumormesser
 Tumor knives
 Cuchillos para tumores
 Couteaux à tumeurs
 Coltelli per tumori

Gefäßmesser
 Vessel knife
 Cuchillo para vaso
 Couteau pour vaisseaux
 Coltello per vasi

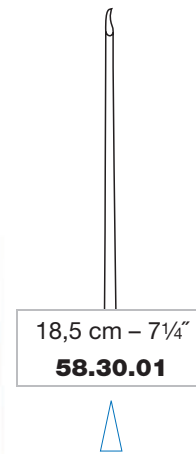
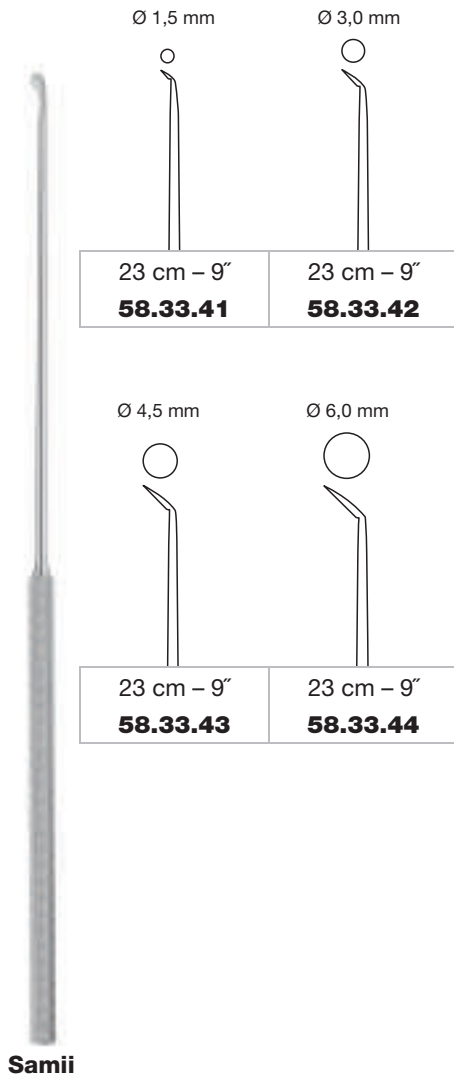

spitz
 sharp
 agudo
 pointu
 acuta

Gefäßmesser
 Vessel knives
 Cuchillos para vasos
 Couteaux pour vaisseaux
 Coltelli per vasi

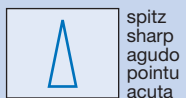
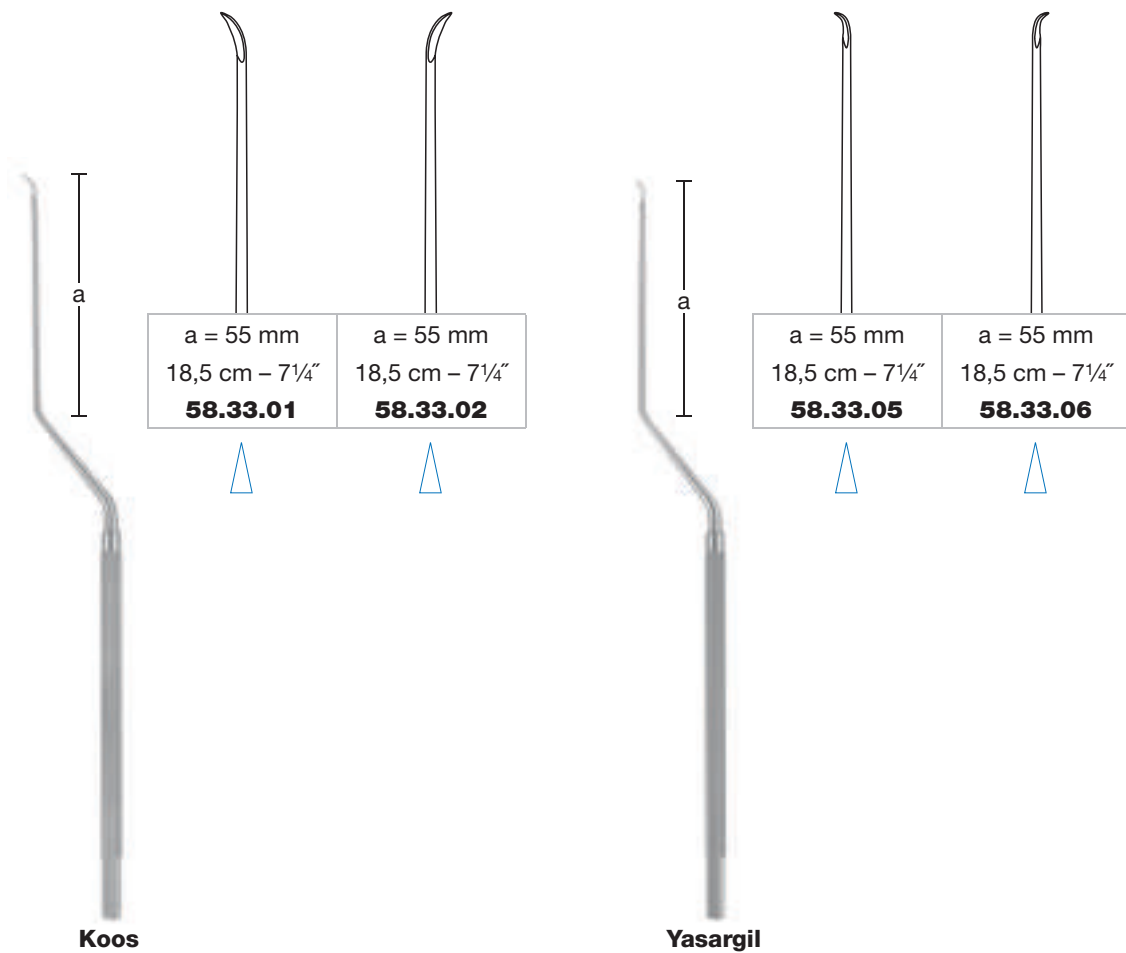



B06

Mikro-Instrumente
Micro Instruments
Micro instrumentos
Micro instruments
Micro strumenti

Fadengabel
 Ligature fork
 Horquilla de hilos
 Pousse-fil
 Forchetta da sutura

Fadenführer
 Ligature guides
 Guía-ligadura
 Guide-fils
 Passafilo

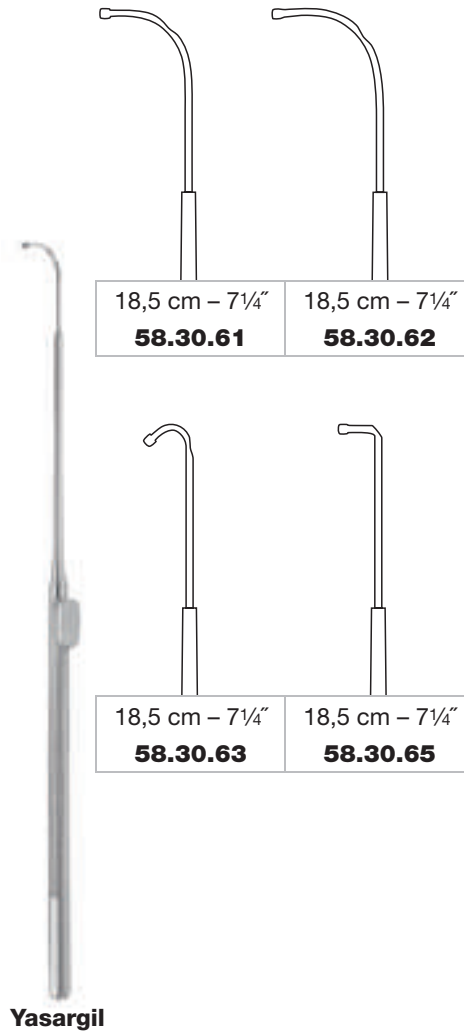
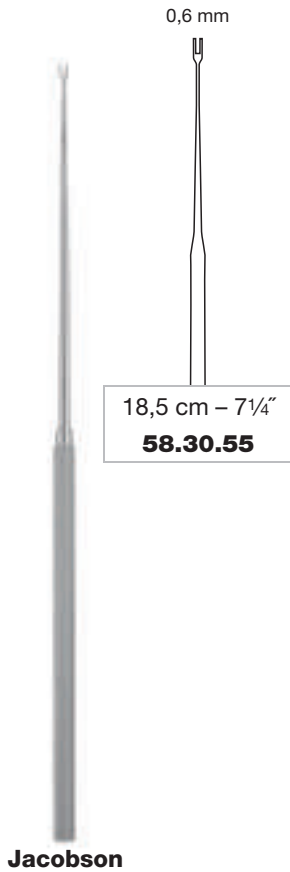
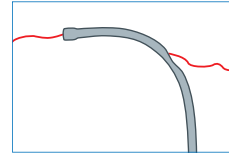

Scharfe Löffel
 Sharp curettes
 Cucharillas cortantes
 Curettes tranchantes
 Cucchiari taglienti

Nadel
 Needle
 Aguja
 Aiguille
 Ago

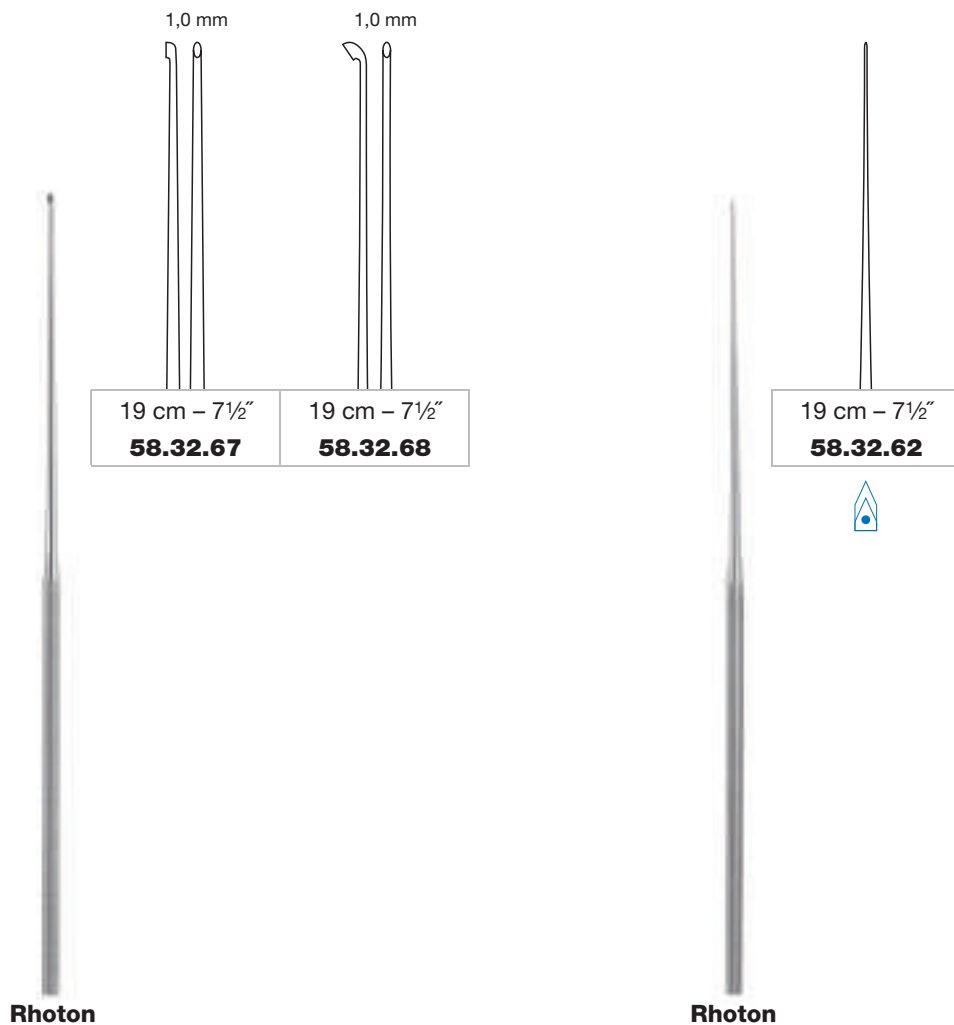

halbscharf
 semi sharp
 semi cortante
 semi tranchant
 semi acuta



B06

Mikro-Instrumente
Micro Instruments
Micro instrumentos
Micro instruments
Micro strumenti

Küretten
 Curettes
 Curetas
 Curettes
 Curette

Scharfer Löffel
 Sharp curette
 Cucharilla cortante
 Curette tranchante
 Cucchiaino tagliente

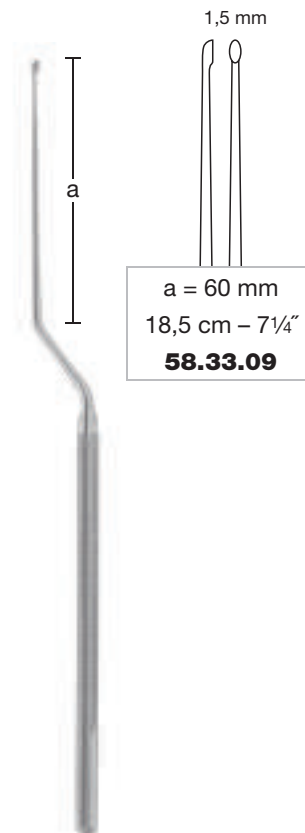
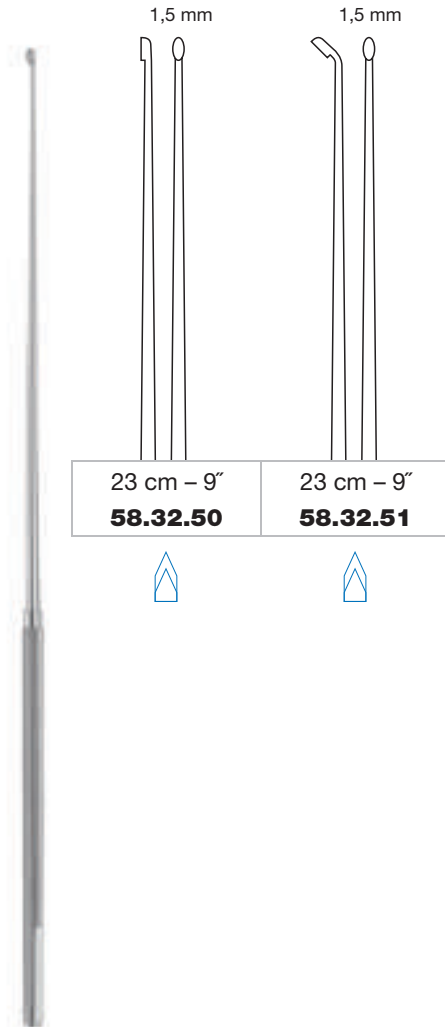

scharf
 sharp
 cortante
 tranchant
 acuta

Spongiosaentnahme aus dem Beckenkamm
Cancellous Bone Extraction from the Iliac Crest
Extracción esponjosa de la cresta ilíaca
Extraction spongieuse de l'os illiaque
Estrazione spongiosa dalla cresta iliaca

B07

Das neue Spongiosaentnahme-Set ermöglicht die perkutane Gewinnung von zylinderförmigem Knochenmark in minimal-invasiver Technik.

The new cancellous bone extraction set can be used for percutaneous harvesting of cylindrical bone marrow with a minimally invasive technique.

El nuevo kit para extracción de la sustancia esponjosa permite la obtención percutánea de médula ósea de forma cilíndrica utilizando una técnica mínimamente invasiva.

Le nouveau set de prélèvement de tissu spongieux permet de recueillir par voie percutanée de moelle osseuse cylindrique grâce à une méthode très mini-invasive.

Il nuovo set per il prelievo della spongiosa consente il prelievo percutaneo di midollo osseo cilindrico con una tecnica mini-invasiva.

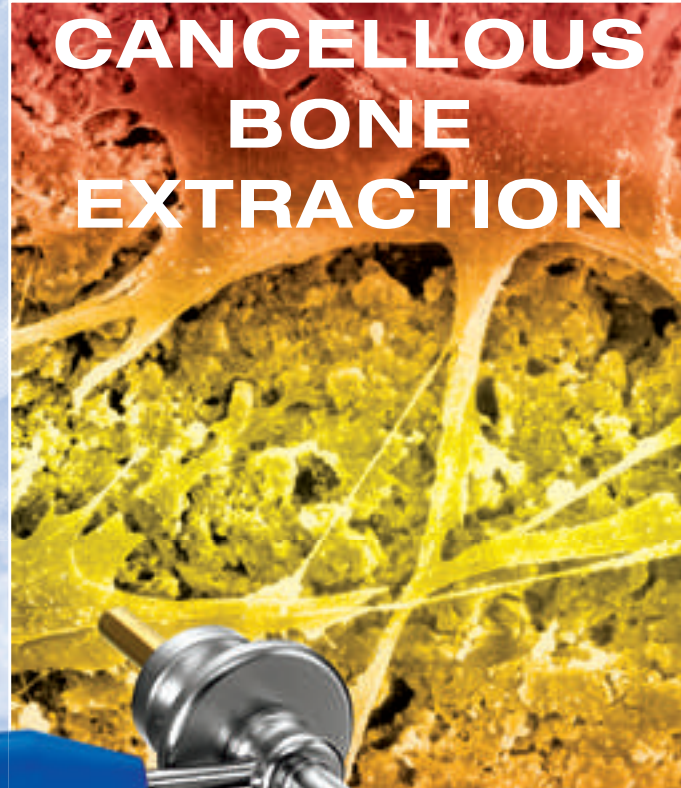

Böhm-Set

entwickelt in Zusammenarbeit mit:
developed in cooperation with:
desarrollado en colaboración con:
développée en collaboration avec:
sviluppatò in collaborazione con:

Dr. med. Heinrich Böhm

Klinik für Wirbelsäulenchirurgie und Querschnittgelähmte
Zentralklinik Bad Berka GmbH, 99437 Bad Berka

**B07**

Spongiosaentnahme aus dem Beckenkamm
Cancellous Bone Extraction from the Iliac Crest
Extracción esponjosa de la cresta ilíaca
Extraction spongieuse de l'os illiaque
Estrazione spongiosa dalla cresta iliaca

Spongiosaentnahme-Set
 Cancellous bone extraction set
 Juego para extracción de esponjosa
 Jeu pour extraction spongieuse
 Set per il prelievo della spongiosa



Böhm-Set		78.41.20
Satz bestehend aus:	78.41.21 Guide sleeve (Ø 8 mm)	1x
Set consisting of:	78.41.22 Hollow drill with ejection mandrel (Ø 6,8 mm)	1x
Juego compuesto por:	78.41.23 Trocar (Ø 7 mm)	1x
Jeu composé de:		
Set composto da:		

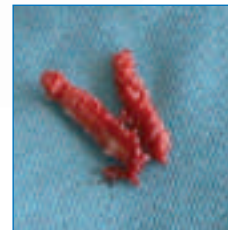
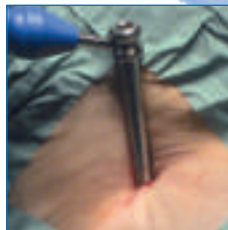
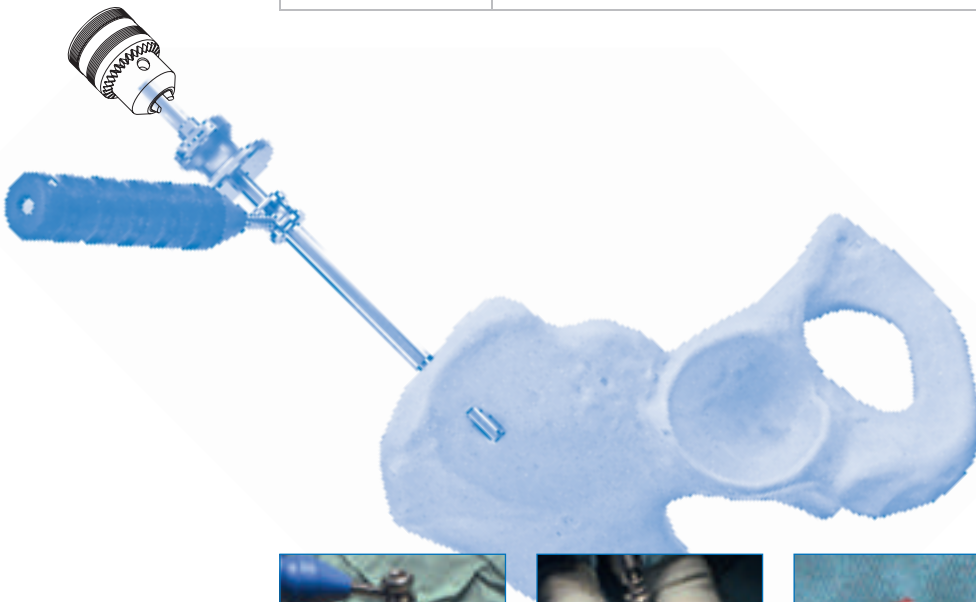

Kunststoffgriff (autoklavierbar bis 134 °C bei 3 bar)
 Plastic handle (autoclavable up to 134 °C at 3 bar)
 Mango de plástico (autoclavable hasta 134 °C bajo presión de 3 bar)
 Manche en plastique (autoclavable à 134 °C sous pression de 3 bars)
 Manico di plastica (autoclavabile fino a 134 °C sotto pressione di 3 bar)



Spongiosaentnahme aus dem Beckenkamm
Cancellous Bone Extraction from the Iliac Crest
Extracción esponjosa de la cresta ilíaca
Extraction spongieuse de l'os illiaque
Estrazione spongiosa dalla cresta iliaca

B07

Führungshülse
 Guide sleeve
 Casquillo de guía
 Douille guidage
 Bussola di guida



a = 6,5 cm – 2½"
78.41.21



mit Sicherheitsanschlag für die richtige Positionierung am knöchernen Beckenkammrand

with safety stop for a correct positioning at the bony edge of the pelvic crest

con garra de tope para la posición correcta en el borde óseo de la cresta iliaca

avec arrêt de sécurité pour un meilleur positionnement au bord de l'os illiaque

con arresto di sicurezza per il posizionamento corretto sul bordo osseo della cresta iliaca

Hohlbohrer für Dreibackenfutter
 Hollow drill for three jaw chuck
 Taladro acanalado para plato de tres mordazas
 Forêt creux pour mandrin à trois mors
 Perforatore cavo per mandrino a tre ganasce

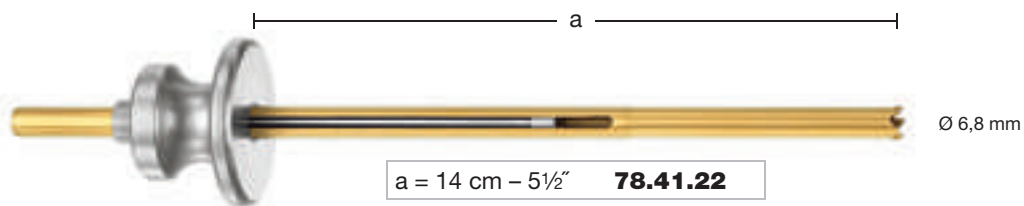

a = 14 cm – 5½"
78.41.22



mit Ausstoßer
 with ejection mandrel
 con espulsor
 avec expulsoir
 con espulsore



Kunststoffgriff (autoklavierbar bis 134 °C bei 3 bar)
 Plastic handle (autoclavable up to 134 °C at 3 bar)
 Mango de plástico (autoclavable hasta 134 °C bajo presión de 3 bar)
 Manche en plastique (autoclavable à 134 °C sous pression de 3 bars)
 Manico di plastica (autoclavabile fino a 134 °C sotto pressione di 3 bar)



Spongiosaentnahme aus dem Beckenkamm
Cancellous Bone Extraction from the Iliac Crest
Extracción esponjosa de la cresta ilíaca
Extraction spongieuse de l'os illiaque
Estrazione spongiosa dalla cresta iliaca

B07

Trokar
Trocar
Trocar
Trocart
Trocar

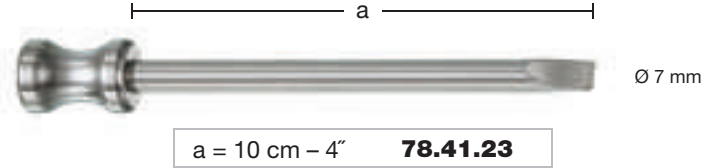

Spongiosaspaltzange
Cancellous bone cleaver
Pinza para cortar esponjosa
Pince à couper les spongieuse
Pinza per tagliare la spongiosa

zum Zerteilen der Spongiosa
for splitting of cancellous bone
para dividir la esponjosa
pour fractionner la matière spongieuse
per tagliare la spongiosa

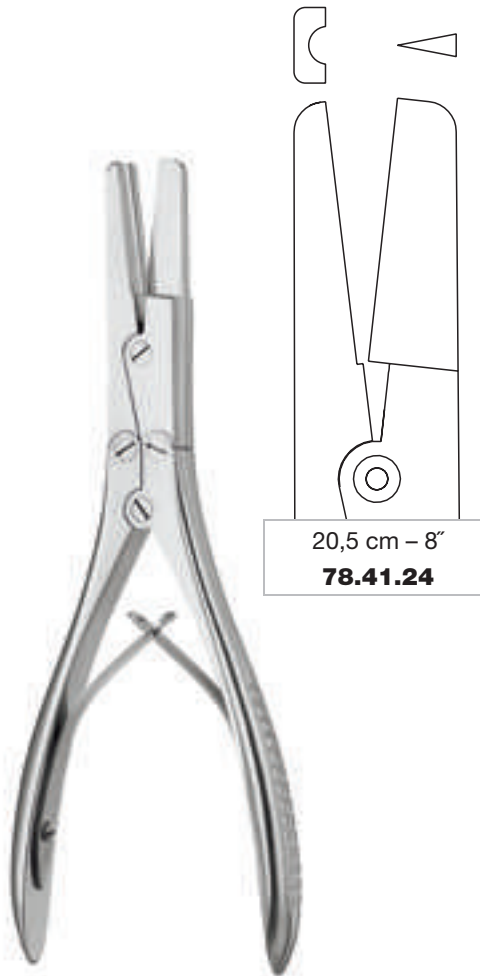

Das Druckluft-Motorensystem "VipAir" von Medicon wurde speziell für das Fräsen und Bohren an Schädel- bzw. Wirbelsäulenknöcheln konzipiert. Das System kombiniert Sicherheit und Präzision in einem ergonomischen Design mit maximaler Leistung bei kleinstmöglicher Bauweise.

The Medicon pneumatic high speed system "VipAir" was specially designed for reaming and drilling procedures at bones of the skull or spine. The system combines safety and precision in an ergonomic design with maximal power in a unit of minimal dimensions.

El sistema de motor neumático "VipAir" de Medicon ha sido concebido específicamente para el fresado y la perforación de huesos del cráneo y de la columna vertebral. El sistema concentra seguridad, precisión y la máxima potencia en un diseño ergonómico y extremadamente compacto.

Le système de moteur pneumatique "VipAir" de Medicon a été spécialement conçu pour le fraisage et le forage des os du crâne et de la colonne vertébrale. Le système allie sécurité, précision et design ergonomique à une performance maximale pour des dimensions aussi compactes que possible.

Il sistema motore pneumatico "VipAir" Medicon è ideato in particolare per fresare e perforare le ossa craniche e della colonna vertebrale. Il sistema combina sicurezza e precisione con un design ergonomico e massime prestazioni, il tutto in una struttura estremamente compatta.

PNEUMATIC HIGH SPEED

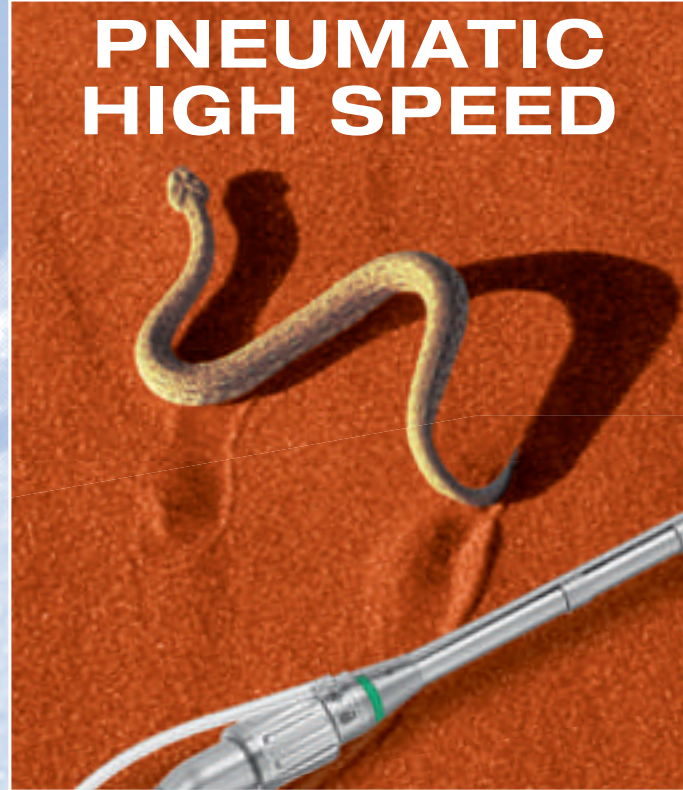

VipAir

PNEUMATIC HIGH SPEED SYSTEM

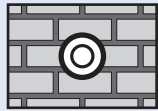

Druckluft
 Compressed air
 Aire comprimido
 Air comprimé
 Aria compressa



Fußpedal
 Foot switch
 Interruptor a pedal
 Interrupteur à pédale
 Interruttore a pedale



Trepanmotor
 Trepan motor
 Motor de trépano
 Moteur à trépan
 Motore trapano



Winkelmotor
 Angled motor
 Motor angulado
 Moteur angulaire
 Motore angolato



Motor mit INTRA-Kupplung
 Motor with INTRA coupling
 Motor con acoplamiento INTRA
 Moteur avec embrayage INTRA
 Motore con accoppiamento INTRA

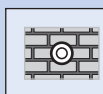

Wandanschluss
 Wall connection
 Pared de conexión
 Connexion au mur
 Attacco parete



Wandschlauch
 Wall tube
 Tubo mural
 Tuyau mural
 Tubo parete

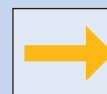

Motorschlauch
 Motor tube
 Tubo de motor
 Tuyau moteur
 Tubo motore

Systemübersicht
System Overview
Vista general al sistema
Aperçu du système
Visione generale del sistema

B08



Trepanfräser
 Trepanation burrs
 Fresas de trépano
 Fraises à trépan
 Punta per perforatore



Arbeitsaufsätze
 Hand pieces
 Cabezales de trabajo
 Pièces à main
 Inserti lavorativi

gewinkelt
 angled
 anguladas
 angulaires
 angolati

gerade
 straight
 rectas
 droites
 retti

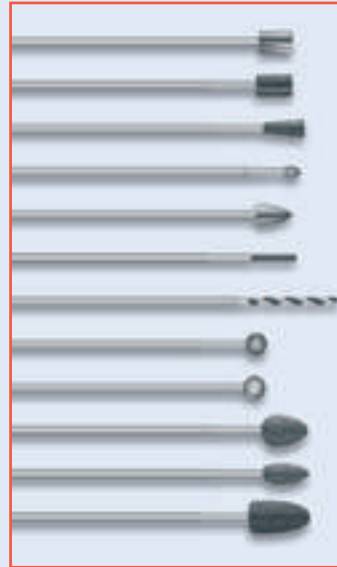

Werkzeuge
 Tools
 Terminales
 Outils
 Punte



Spülrohre
 Irrigation tubes
 Tubos de irrigación
 Tuyaux d'irrigation
 Tubi d'irrigazione

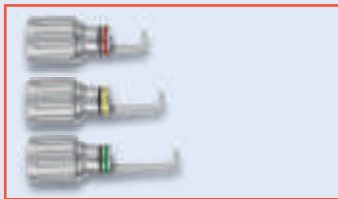

Kraniotome
 Craniotomes
 Cráneotomos
 Crâniotomes
 Craniotomi

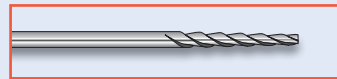

Kraniotomfräser
 Craniotome burrs
 Fresas para craneotomo
 Fraises pour crâniotome
 Frese per craniotomo



Chirurgische Handstücke und Mikrosägen
 Surgical hand pieces and micro saws
 Piezas de mano quirúrgicas y micro sierras
 Pièces à main chirurgicales et micro scies
 Manipoli chirurgici e micro seghe

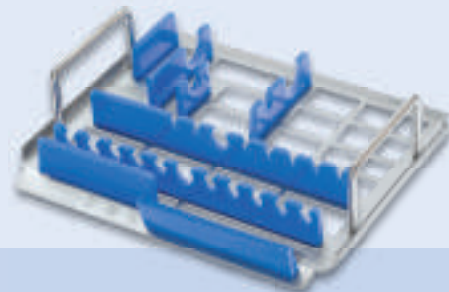

**B08**

Vorteile
Advantages
Ventajas
Avantages
Vantaggi

VipAir
 PNEUMATIC HIGH SPEED SYSTEM

Klein und handlich
small and handy
pequeño y manejable
petit et maniable
piccolo e maneggevole

ergonomisch
ergonomic
ergonómico
ergonomique
ergonomico

ölfrei
oil free
libre de aceite
sans huile
senza olio

leise
quiet
silencioso
silencieux
silenzioso

sicher
secure
seguro
sûr
sicuro

luftgekühlt
air-cooled
refrigerado por aire
refroidissement
raffreddato ad aria



Maximale Leistung bei kleinstmöglicher Bauweise
 Maximum performance using the smallest possible construction
 Rendimiento máximo con una construcción compacta
 Puissance maximale pour la plus petite construction possible
 Rendimento massimo grazie ad una costruzione il più possibile ridotta

Ergonomie und Balance garantieren Präzision und Instrumentenkontrolle
 Ergonomy and balance guarantee precision and instrument control
 Ergonomía y equilibrio garantizan precisión y el control sobre el instrumento
 Ergonomie et balance garantissant la précision et le contrôle des instruments
 Ergonomia ed equilibrio garantiscono precisione e controllo sullo strumento

Ölfreier und wartungsfreundlicher Motor
 Oil free motor and easy to maintain
 Motor libre de aceite que requiere poco mantenimiento
 Moteurs sans huile et entretien facile
 Motore senza olio che non richiede manutenzione

Leise Motorengeräusche ermöglichen ein stressfreies Arbeiten
 A low-noise motor ensures stressfree working environment
 Un motor silencioso posibilita un trabajo sin estrés
 Moteurs silencieux permettant un travail sans stress
 Il motore silenzioso rende possibile un lavoro senza stress

Sichere und schnelle Bedienbarkeit durch MEDICON-Spezialkupplung
 Secure and quick handling due to the MEDICON special coupling
 Manejo rápido y seguro mediante el acoplamiento MEDICON
 Maniement sûr et rapide par accouplement MEDICON spécial
 Utilizzo sicuro e veloce grazie all'accoppiamento speciale MEDICON

Kühlwirkung der Druckluft verhindert ein Erwärmen des Motors
 Cooling effect of compressed air avoids warming up of the motor
 Refrigeración por aire comprimido evita el calentamiento del motor
 L'effet de refroidissement par l'air comprimé empêche la surchauffe du moteur
 L'azione refrigerante dell'aria compressa impedisce il surriscaldamento del motore

**Druckluftmotoren
Pneumatic High Speed Motors
Motores neumáticos
Moteurs pneumatiques
Motori pneumatici**

B08

Motor mit INTRA-Kupplung
Motor with INTRA coupling
Motor con acoplamiento INTRA
Moteur avec embrayage INTRA
Motore con accoppiamento INTRA

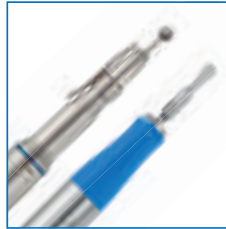

Für Standard-Chirurgiehandstücke und Mikro-Sägen
For standard surgical hand pieces and micro saws
Para piezas de mano quirúrgicas estándar y micro sierras
Pour pièces à main chirurgicales standard et de micro scies
Per l'utilizzo di manipoli chirurgici standard e micro seghe

DIN 13940
ISO 3964



1:1

10 cm - 4" **93.00.22**

links
left
izquierda
gauche
sinistra
rechts
right
derecha
droite
destra

1. = 20.000 U/min

2. = 25.000 U/min

Zweistufiger Rechts- und Linkslauf
Two-stage clockwise/counter clockwise motion
Dos etapas de funcionamiento (derecha/izquierda)
Deux vitesses possibles tant à droite que à gauche
Funzionamento in senso orario ed antiorario a due velocità

- ▶ Sehr leiser und vibrationsfreier Lauf
- ▶ Kleine Bauweise, geringes Gewicht und stark im Durchzug
- ▶ Zweistufiger Rechts- und Linkslauf

- ▶ Quiet and without vibrations
- ▶ Small, lightweight construction and powerful torque
- ▶ Two-stage clockwise/counter clockwise motion

- ▶ Muy silencioso y sin vibraciones durante el uso
- ▶ Construcción ergonómica, poco peso y momento de giro muy elevado
- ▶ Dos etapas de funcionamiento (derecha/izquierda)

- ▶ Silencieux et sans vibration
- ▶ Construction micro, poids léger et puissance de rotation élevée
- ▶ Deux vitesses possibles tant à droite que à gauche

- ▶ Funzionamento molto silenzioso e privo di vibrazioni
- ▶ Dimensioni ridotte, peso minimo ed elevato momento torcente
- ▶ Funzionamento in senso orario ed antiorario a due velocità

Technische Daten Technical data Especificaciones técnicas Caractéristiques techniques Dati tecnici	Drehzahl bei 8 bar Revolutions per minute at 8 bar Número de revoluciones a 8 bar Nombre de tours à 8 bar Numero di giri a 8 bar	Drehmoment bei 8 bar Torque at 8 bar Momento de giro a 8 bar Couple à 8 bar Momento torcente a 8 bar	Leistung bei 8 bar Output at 8 bar Potencia a 8 bar Puissance à 8 bar Potenza a 8 bar	Empfohlener Druck Recommended pressure Presión recomendada Pression recommandée Pressione raccomandata	Freigegebener Druck Approved pressure Presión permitida Pression libérée Pressione permessa
93.00.22	20.000-25.000 U/min	4,0 Ncm	44 Watt	8 bar	8±2 bar

**B08**

Druckluftmotoren
Pneumatic High Speed Motors
Motores neumáticos
Moteurs pneumatiques
Motori pneumatici

VipAir
 PNEUMATIC HIGH SPEED SYSTEM

Trepanmotor
 Trepan motor
 Motor de trépano
 Moteur à trépan
 Motore trapano

Mit niedriger Drehzahl, hohem Drehmoment und HUDSON-Anschluß
 With low speed, high torque and HUDSON connection
 Con un número de revoluciones bajo, un momento de giro alto y conexión HUDSON
 Avec régime faible, rotation rapide et raccord HUDSON
 Con a basso numero di giri, elevato momento torcente ed attacco HUDSON



15,5 cm - 6 1/8" **93.00.25**

Technische Daten Technical data Especificaciones técnicas Caractéristiques techniques Dati tecnici	Drehzahl bei 8 bar Revolutions per minute at 8 bar Número de revoluciones a 8 bar Nombre de tours à 8 bar Numero di giri a 8 bar	Drehmoment bei 8 bar Torque at 8 bar Momento de giro a 8 bar Couple à 8 bar Momento torcente a 8 bar	Leistung bei 8 bar Output at 8 bar Potencia a 8 bar Puissance à 8 bar Potenza a 8 bar	Empfohlener Druck Recommended pressure Presión recomendada Pression recommandée Pressione raccomandata	Freigegebener Druck Approved pressure Presión permitida Pression libérée Pressione permessa
93.00.25	950 U/min	45,0 Ncm	88 Watt	8 bar	8±2 bar

Kraniotome
 Craniotomes
 Cráneotomos
 Crâniotomes
 Craniotomi



1:1

a = 10 mm	a = 15 mm	a = 20 mm
S	M	L
93.00.30	93.00.32	93.00.34

Kraniotomfräser
 Craniotome burrs
 Fresas para craneotomo
 Fraises pour crâniotome
 Frese per craniotomo

STERILE R

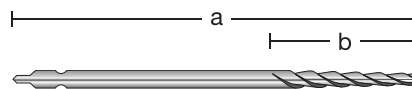

1:1

Ø 1,5 mm	Ø 1,5 mm	Ø 1,5 mm
a = 48 mm	a = 52 mm	a = 66 mm
b = 12 mm	b = 16 mm	b = 20 mm
S	M	L
93.01.15	93.03.37	93.03.38

Trepanfräser
 Trepanation burrs
 Fresas de trépano
 Fraises à trépan
 Punta per perforatore

mit Montageschlüssel
 with mounting wrench
 con llave de ensamblaje
 avec clé de montage
 con chiave di assemblaggio



1:1

HUDSON-Anschluß
 HUDSON connection
 Conexión HUDSON
 Raccord HUDSON
 Attacco HUDSON

a = Ø 7 mm	a = Ø 11 mm	a = Ø 16 mm
93.04.00	93.04.05	93.04.10

**B08**

Druckluftmotoren
Pneumatic High Speed Motors
Motores neumáticos
Moteurs pneumatiques
Motori pneumatici

VipAir
 PNEUMATIC HIGH SPEED SYSTEM

Winkelmotor
 Angled motor
 Motor angulado
 Moteur angulaire
 Motore angolato

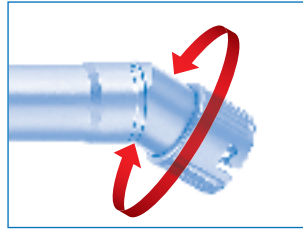

Das drehbare Winkelstück verhindert ein Verwinden des Motorschlauches
 The rotatable elbow avoids a torsion of the motor tube
 La pieza de mano giratoria evita una torsión del tubo de motor
 Le coude à plat pivotant empêche une torsion du tuyau moteur
 Il raccordo girevole impedisce una torsione del tubo motore

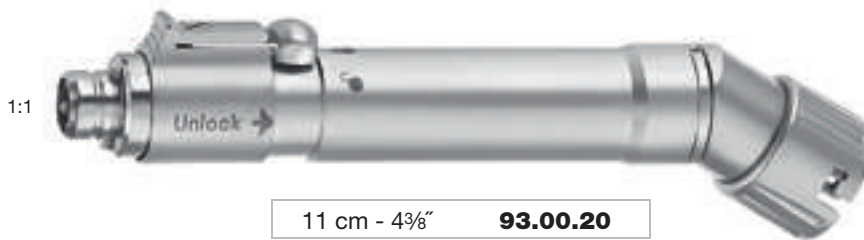

entsichert
 unlocked
 desasegurado
 déverrouillé
 sbloccare

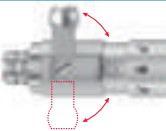

gesichert
 locked
 asegurado
 verrouillé
 bloccare



Sicherungsriegel der Kupplung
 Safety lock of coupling
 Pasador de seguridad del acoplamiento
 Embayage à verrou de sécurité
 Chiusura di sicurezza dell'accoppiamento

Technische Daten Technical data Especificaciones técnicas Caractéristiques techniques Dati tecnici	Drehzahl bei 8 bar Revolutions per minute at 8 bar Número de revoluciones a 8 bar Nombre de tours à 8 bar Numero di giri a 8 bar	Drehmoment bei 8 bar Torque at 8 bar Momento de giro a 8 bar Couple à 8 bar Momento torcente a 8 bar	Leistung bei 8 bar Output at 8 bar Potencia a 8 bar Puissance à 8 bar Potenza a 8 bar	Empfohlener Druck Recommended pressure Presión recomendada Pression recommandée Pressione raccomandata	Freigegebener Druck Approved pressure Presión permitida Pression libérée Pressione permessa
93.00.20	100.000 U/min	2,8 Ncm	60 Watt	6-8 bar	8±2 bar

Arbeitsaufsätze und Spülrohre
Hand Pieces and Irrigation Tubes
Cabezales de trabajo y tubos de irrigación
Pièces à main et tuyaux d'irrigation
Inserti lavorativi e tubi d'irrigazione

B08

Arbeitsaufsätze
 Hand pieces
 Cabezales de trabajo
 Pièces à main
 Inserti lavorativi



1:1

a = 20 mm	a = 40 mm	a = 60 mm	a = 80 mm	a = 100 mm
S	M	L	XL	XXL
93.00.40	93.00.42	93.00.44	93.00.46	93.00.48

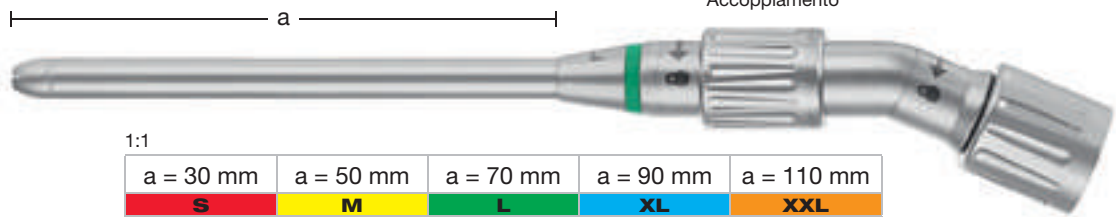
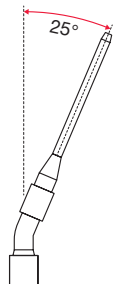

Kupplung
 Coupling
 Acoplamiento
 Embrayage
 Accoppiamento

1:1

a = 30 mm	a = 50 mm	a = 70 mm	a = 90 mm	a = 110 mm
S	M	L	XL	XXL
93.00.50	93.00.52	93.00.54	93.00.55	93.00.56

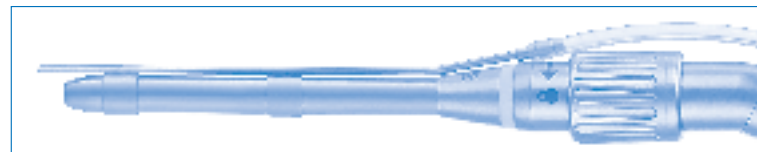

Spülrohre
 Irrigation tubes
 Tubos de irrigación
 Tuyaux d'irrigation
 Tubi d'irrigazione



1:1

a = 45 mm	a = 55 mm	a = 75 mm	a = 90 mm	a = 115 mm
S	M	L	XL	XXL
93.00.70	93.00.72	93.00.74	93.00.76	93.00.78



Werkzeuge
Tools
Terminales
Outils
Punte

B08

VipAir
PNEUMATIC HIGH SPEED SYSTEM

Diamant-Kugelfräser
Diamond dust burrs
Fresas redondas de diamante
Fraises forme boule diamantées
Frese a pallina diamantate

STERILE | R

normal
regular
normal
normale
normale



1:1

S	M	L	XL	XXL	
93.01.20	93.02.01	93.03.01	93.06.01	93.04.01	Ø 1,0 mm
93.01.22	93.02.03	93.03.03			Ø 1,8 mm
			93.06.03	93.04.03	Ø 2,0 mm
	93.02.05	93.03.05			Ø 2,3 mm
93.01.01	93.02.07	93.03.07	93.06.07	93.04.07	Ø 3,1 mm
93.01.03	93.02.09	93.03.09	93.06.09	93.04.09	Ø 4,0 mm
93.01.05	93.02.11	93.03.08	93.06.11	93.04.21	Ø 5,0 mm
93.01.07	93.02.13	93.03.10	93.06.13	93.04.23	Ø 6,0 mm

grob
abrasivo
abrasivo
abrasivo
abrasivo



1:1

S	M	L	XL	XXL	
	93.02.66	93.03.66			Ø 5,0 mm
	93.02.68	93.03.68			Ø 6,0 mm

Diamant-Walzenfräser
Diamond cutting burrs, barrel style
Fresas cilíndricas de diamante
Fraises cylindriques diamantées
Frese cilindriche diamantate

STERILE | R

1:1

S	M	L	XL	XXL	
	93.02.54				Ø 3,0 mm
	93.02.52	93.03.50			Ø 6,0 mm

Rosenbohrer
Rosen burrs
Brocas Rosen
Fraises Rosen
Perforatori di Rosen

STERILE | R

1:1

S	M	L	XL	XXL	
	93.02.45				Ø 1,0 mm
	93.02.17	93.03.11			Ø 1,8 mm
			93.07.03	93.05.03	Ø 2,0 mm
	93.02.19	93.03.13			Ø 2,3 mm
93.01.09	93.02.21	93.03.15	93.07.05	93.05.07	Ø 3,1 mm
93.01.11	93.02.23	93.03.17	93.07.07	93.05.09	Ø 4,0 mm
93.01.13	93.02.25	93.03.19	93.07.08	93.05.11	Ø 5,0 mm
93.01.23	93.02.30	93.03.20	93.07.09	93.05.13	Ø 6,0 mm



mit Diamantkörnung
with diamond grit
con granulación de diamante
avec grains de diamant
con granulazione di diamante



mit blanker Stirnfläche
with polished front part
con superficie frontal lisa
avec partie frontale lisse
con superficie frontale liscia



Walzenfräser
Cutting burrs, barrel style
Fresas cilíndricas
Fraises cylindriques
Frese cilindriche

STERILE | R



1:1

S	M	L	XL	
	93.02.41			Ø 3,0 mm
	93.02.43	93.03.23		Ø 6,0 mm

Wirbelkörperfräser
Vertebra burrs
Fresas para vértebras
Fraises vertébrales
Frese per vertebre

STERILE | R



1:1

S	M	L	XL	
	93.02.35	93.03.35		Ø 5,0 mm

Neurofräser
Neuro burrs
Fresas neuro
Fraises neuro
Frese neuro

STERILE | R



1:1

S	M	L	XL	
	93.02.31	93.03.21		Ø 2,1 mm
	93.02.32	93.03.22	93.06.30	Ø 3,0 mm

Fräser
Burrs
Fresas "Flameshape"
Fraises
Frese

STERILE | R



1:1

S	M	L	XL	
	93.02.37			Ø 3,0 mm
	93.02.39			Ø 6,0 mm

Zementbohrer
Cement drill
Broca para cemento
Fraise à ciment
Perforatore per cemento

STERILE | R



1:1

S	M	L	XL	
	93.02.33			Ø 2,4 mm

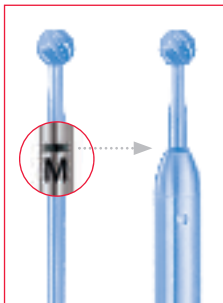

Alle Werkzeuge besitzen eine Markierung zur schnellen und sicheren Positionierung des Werkzeuges im Arbeitsaufsatz und eine Längenangabe (S, M, L, XL, XXL) zur besseren Unterscheidung.

All tools have a marking for a quick and secure positioning of the tool into the hand piece as well as an indication of length (S, M, L, XL, XXL) for a better distinction.

Los terminales disponen de una marca para el posicionamiento rápido y seguro en el cabezal. Esta marca sirve también como indicación de longitud (S, M, L, XL, XXL).

Tous les outils ont un marquage permettant un positionnement sûr et rapide dans les inserts, et un marquage de taille (S, M, L, XL, XXL) pour un meilleur choix.

Tutte le punte presentano una marcatura per posizionarle velocemente ed in modo sicuro negli inserti. La stessa marcatura serve anche a distinguere meglio la lunghezza (S, M, L, XL, XXL).



mit Diamantkörnung
with diamond grit
con granulación de diamante
avec grains de diamant
con granulazione di diamante



Werkzeuge
Tools
Terminales
Outils
Punte

B08

VipAir
PNEUMATIC HIGH SPEED SYSTEM

Spiralbohrer
Twist drills
Brocas espirales
Fraises en spirale
Perforatori a spirale

STERILE | R

1:1

S	M	L	XL	
93.01.17	93.02.47	93.03.40	93.06.08	Ø 1,5 mm
93.01.19	93.02.49			Ø 2,0 mm

Dermabrasionsfräser
Burs for dermabrasion
Fresas para la dermoabrasión
Fraises à dermabrasion
Frese per la dermoabrasione

STERILE | R

feinkörnig
fine-grained
de grano fino
à grains fins
granuloso



1:1

M	
93.02.20	Ø 9 mm

feinkörnig
fine-grained
de grano fino
à grains fins
granuloso



1:1

M	
93.02.22	Ø 6 mm

grobkörnig
coarse-grained
de grano grueso
à gros grains
grossolano



1:1

M	
93.02.24	Ø 10 mm

Spritzschutz für die Dermabrasion
Splash guard for dermabrasion
Protección contra riego para la dermoabrasión
Protection anti-projections à dermabrasion
Protezione antispruzzo per la dermoabrasione

Luer-Lock



1:1

4,5 cm - 1¾" **93.00.60**

Schützt das Operationsfeld vor Verunreinigung
Protects the operation area from contamination
Protege el campo operatorio de ensuciamiento
Protège le champ opératoire des projections
Protegge il campo operatorio dalle impurità



mit Diamantkörnig
with diamond grit
con granulacion de diamante
avec grains de diamant
con granulazione di diamante

Fußpedal und Schläuche
Foot Switch and Tubes
Interruptor a pedal y tubos
Interrupteur à pédale et tuyaux
Interruttore a pedale e tubi

B08

Fußpedal
 Foot switch
 Interruptor a pedal
 Interrupteur à pédale
 Interruttore a pedale



110 × 200 × 140 mm
93.00.10

Wandschläuche
 Wall tubes
 Tubos murales
 Tuyaux muraux
 Tubi parete



 "OPEN-END" **93.00.00** 4,5 m 



 "DRAEGER" **93.00.02** 4,5 m 



 "SYNTHES" **93.00.04** 4,5 m 

Motorschlauch
 Motor tube
 Tubo de motor
 Tuyau moteur
 Tubo motore



 **93.00.15** 2,5 m 

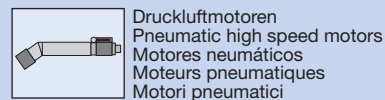
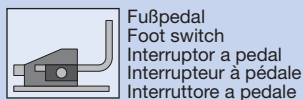
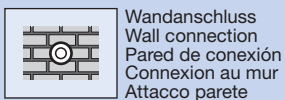

**B08**

Zubehör
Accessories
Accesorios
Accessoires
Accessori

VipAir
 PNEUMATIC HIGH SPEED SYSTEM

Reinigungs-Tray für die maschinelle Reinigung
 Cleaning tray for mechanical cleaning
 Bandeja de limpieza para la limpieza automática
 Tray de nettoyage pour nettoyage en machine
 Supporto di pulizia per la pulizia a macchina

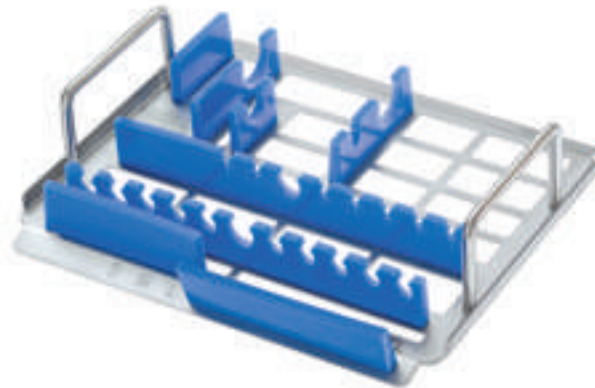
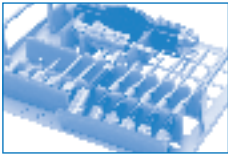
240 × 200 × 60 mm **93.00.83**

Doppelcontainer
 Double container
 Contenedor doble
 Container double
 Contenitore doppio

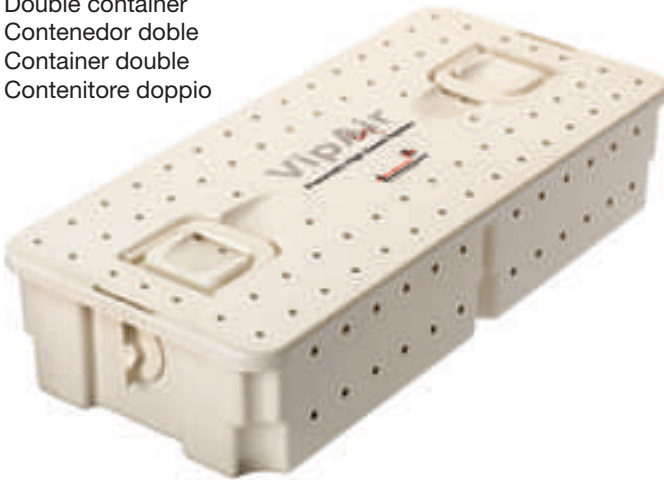
502 × 239 × 102 mm **93.00.85**

Werkzeugkassette mit Silikonmatte
 Tools tray including silicon mat
 Caja para terminales con estera de silicona
 Cassette pour outils avec tapis en silicone
 Cassetta per attrezzi con tappetino in silicone

190 × 102 × 19 mm **49.90.00**

Motorschmiermittel
 Lubrication of the motor
 Lubrificante para el motor
 Lubrifiant pour le moteur
 Lubrificante per motore

500 ml **63.69.96**

Sprühadapter
 Spray adaptor
 Adaptador de spray
 Adaptateur du spray
 Adattatore per spray



1:1

35 mm / Ø 9 mm **93.00.80**

Kunststoff (autoklavierbar bis 134 °C bei 3 bar)
 Plastic (autoclavable up to 134 °C at 3 bar)
 Plástico (autoclavable hasta 134 °C bajo presión de 3 bar)
 Plastique (autoclavable à 134 °C sous pression de 3 bars)
 Plastica (autoclavabile fino a 134 °C sotto pressione di 3 bar)



**Implantate für die Wirbelsäule
Implants for Spine
Implantes para la columna vertebral
Implants pour la colonne vertébrale
Impianti per la colonna vertebrale**

C

**Diese Rubrik beinhaltet nur Werbeseiten (keine Artikelnummern)
This category contains only advertising pages (no article number)
Esta sección solo contiene páginas publicitarias (ningún número de referencia)
Cette rubrique ne contient que des pages publicitaires (pas de références)
Questa rubrica contiene solo pagine pubblicitarie (nessun numero di articolo)**

**neuro
SPINALIS**

**C01****Set zur C2/C1-Verschraubung und Dens-Fixierung****Set for Screw Joint C2/C1 and Dens Fixation****Juego para atornillar las vértebras C2/C1 y fijar la apófisis odontoides****Set de vissage C2/C1 et de fixation du processus odontoïde****Set per l'avvitamento C2/C1 e fissaggio del dente**

TWINTUBE

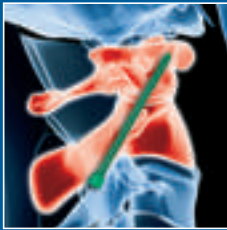

Verschraubung der beiden zervikalen Wirbel C2 und C1 von dorsal
Screw fixation of the two cervical vertebrae C2 and C1 from dorsal
Atornillado de las vértebras cervical C2 y C1 desde dorsal
Vissage des deux vertèbres cervicales C2 et C1 du côté dorsale
Avvitamento delle vertebre cervicali C2 e C1 dal lato dorsale



Stabilisierung einer Fraktur des Dens C2 von ventral
Stabilising a fracture of the dens 2 from ventral
Estabilización de fracturas de la apófisis odontoides de C2 desde ventral
Stabilisation d'une fracture du processus odontoïde C2 du côté ventrale
Stabilizzazione di una frattura del dente C2 dal lato ventrale



[1 SET for 2 INDICATIONS]



Schrauben in verschiedenen Längen
Screws in different lengths
Tornillos de distinta longitud
Vis de différentes longueurs
Viti in diverse lunghezze



Nach korrekter Positionierung der Trokarhülsen können beide Schraubenlager gebohrt und die Schrauben in passender Länge gesetzt werden.

After correct positioning of the trocar sleeves, both screw supports can be drilled and the screws of appropriate length can be placed.

Tras posicionar correctamente las vainas de trocar, es posible taladrar los dos orificios para colocar los tornillos de longitud apropiada.

Après positionnement correct des douilles de trocar, les deux logements à vis peuvent être percés et les vis de longueur adéquate peuvent être insérées.

Dopo il posizionamento corretto delle guaine per trocar entrambe le viti per cuscinetto possono essere forate e le viti della lunghezza adeguata inserite in posizione.

Set zur C2/C1-Verschraubung und Dens-Fixierung
Set for Screw Joint C2/C1 and Dens Fixation
Juego para atornillar las vértebras C2/C1 y fijar la apófisis odontoides
Set de vissage C2/C1 et de fixation du processus odontoïde
Set per l'avvitamento C2/C1 e fissaggio del dente

C01



451.04.51

Die Farbcodierung (1) sowie die Tiefenkontrolle (2) gewährleisten ein passgenaues Eindrehen der Schrauben.

Colour coding (1) and depth verification (2) ensure exact insertion of the screws.

La codificación cromática (1) y el control de profundidad (2) aseguran una introducción precisa y a medida de los tornillos.

Le codage couleur (1) ainsi que le contrôle de profondeur (2) garantissent un vissage précis des vis.

La codifica per colore (1) e il controllo della profondità (2) garantiscono un avvitamento adeguato delle viti.

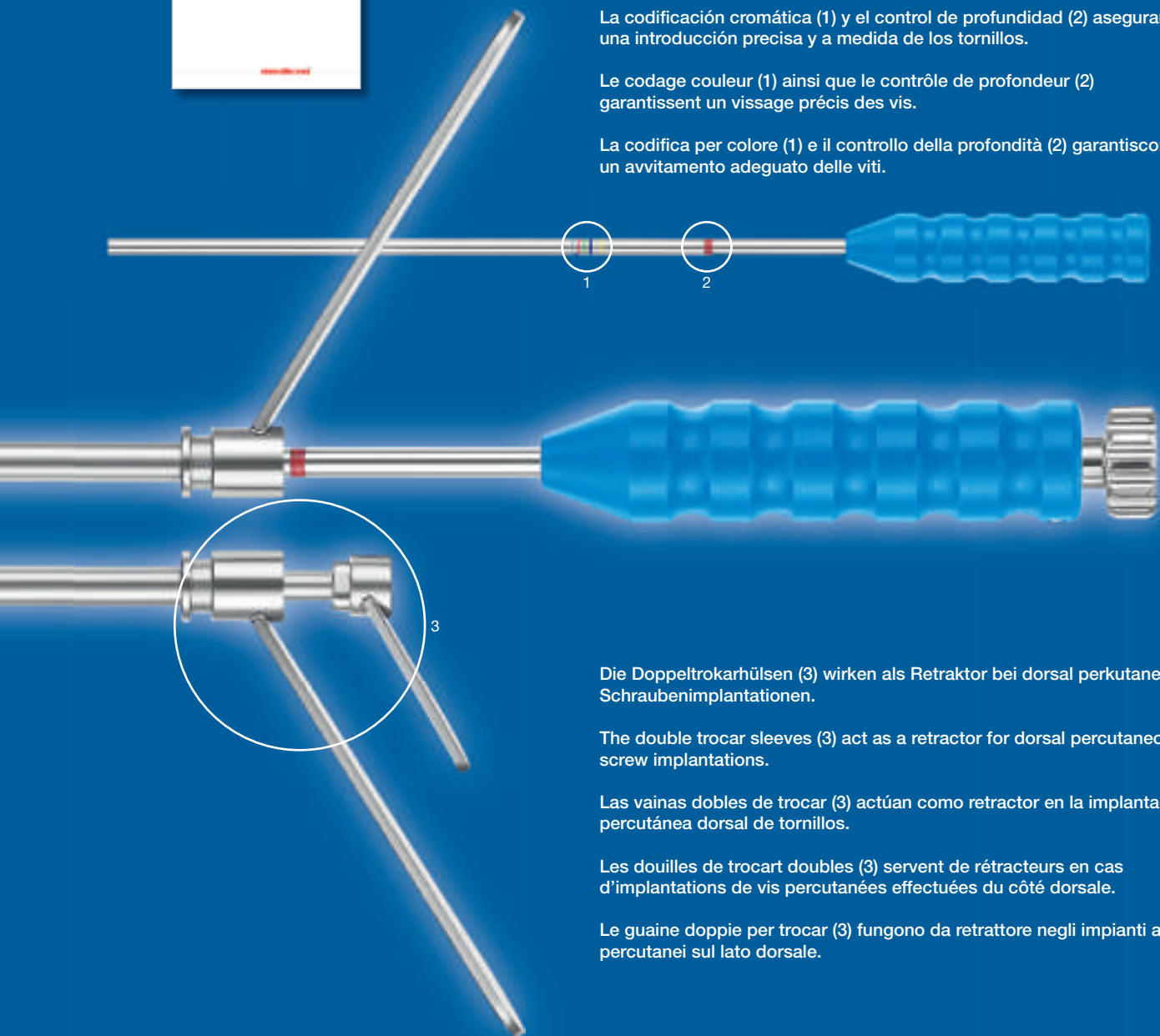

Die Doppeltrokarhülsen (3) wirken als Retraktor bei dorsal perkutanen Schraubenimplantationen.

The double trocar sleeves (3) act as a retractor for dorsal percutaneous screw implantations.

Las vainas dobles de trocar (3) actúan como retractor en la implantación percutánea dorsal de tornillos.

Les douilles de trocar doubles (3) servent de rétracteurs en cas d'implantations de vis percutanées effectuées du côté dorsale.

Le guaine doppia per trocar (3) fungono da retrattore negli impianti a vite percutanei sul lato dorsale.



Weitere Informationen finden Sie in unserem Sonderprospekt.
 For further information please see our special brochure.
 Informaciones adicionales se encuentran en nuestro folleto especial.
 Vous trouverez de plus amples informations dans notre prospectus spécial.
 Troverete più informazioni nel nostro depliant speciale.

Wirbelkörperersatz für die zervikale Wirbelsäule
Vertebral Body Replacement for Cervical Spine
Sustitución de cuerpo vertebral para la columna vertebral cervical
Le remplacement du corps vertébral pour la colonne vertébrale cervicale
Sostituto del corpo vertebrale per la colonna vertebrale cervicale



451.04.62



mediExpand

VERTEBRAL BODY REPLACEMENT

Cervical



Zur Rekonstruktion nach ein- oder mehrsegmentalen Korporektomien an der zervikalen Wirbelsäule
 For reconstruction of single or multi segment corporectomies on the cervical spine
 Para la reconstrucción tras corporectomías de uno o varios segmentos en la columna vertebral cervical
 Pour reconstruction après corporectomies mono ou multi-segmentaires de la colonne vertébrale cervicale
 Per la ricostruzione dopo corporectomie ad uno o più segmenti alla colonna vertebrale cervicale

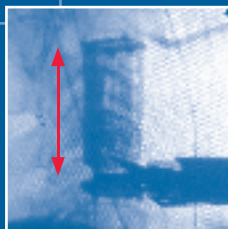

Stufenlose Vergrößerung zur individuellen Versorgung
 Continuously adjustable size for individual treatment
 Expansión continua para un tratamiento individual
 Expansion progressive pour appareillage individuel
 Ingrandimento a livelli per alimentazione singola



Wirbelkörperersatz für die zervikale Wirbelsäule
Vertebral Body Replacement for Cervical Spine
Sustitución del cuerpo vertebral para la columna vertebral cervical
Le remplacement du corps vertébral pour la colonne vertébral cervicale
Sostituto del corpo vertebrale per la colonna vertebrale cervicale

C02

Gute Sicht auf die Dura
 Good view of the dura
 Buena visión de la duramadre
 Bonne visibilité de la dure-mère
 Buona visuale sulla Dura



Maximaler Raum zum Auffüllen von Spongiosa
 Maximum space for spongiosa filling
 Máximo espacio para el relleno de hueso esponjoso
 Espace maximal pour le comblement de l'os spongieux
 Spazio massimo per il riempimento con spongiosa



Anatomische Form zur Wiederherstellung des lordotischen Profils
 Anatomic shape for restoration of the lordotic profile
 Forma anatomica para el restablecimiento del perfil lordótico
 Forme anatomique pour le rétablissement du profil lordotique
 Forma anatomica per il ripristinamento del profilo lordotico



Große Fläche für die knöcherne Durchbauung
 Large area for bony fusion
 Amplia superficie para la fusión ósea
 Surface étendue pour la consolidation osseuse
 Grande superficie per la fusione ossea



Sichere Verankerung in den angrenzenden Endplatten
 Secure anchoring in the adjoining end plates
 Anclaje seguro en las placas terminales adyacentes
 Ancrage sûr dans les plaques d'extrémité adjacentes
 Sicuro ancoraggio nei piatti vertebrali limitrofi





C03

Implantate für die zervikale Wirbelsäule
Implants for the Cervical Spine
Implantes para la columna vertebral cervical
Implants pour la colonne vertébrale cervicale
Impianti per la colonna vertebrale cervicale

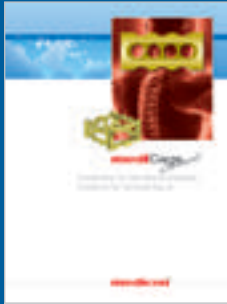

451.04.22



mediCage
Cervical

Der "MediCage-cervical" wurde zur interkorporellen Fusion an der zervikalen Wirbelsäule entwickelt. Sein offenes Design bietet optimalen Raum zum Auffüllen von Spongiosa und eine große Fläche für die knöcherne Durchbauung. Die konische Form des Cages ermöglicht die Wiederherstellung des lordotischen Profils. Zur Gewährleistung einer universellen Anwendung ist das Implantat in verschiedenen Größen erhältlich.

The "MediCage cervical" was developed for intercorporeal fusion on the cervical spine. Its open design provides best possible space for spongiosa filling and a large area for ossification. The conical shape of the cage allows restoration of the lordotic profile. The implant is available in different sizes to allow universal application.

El "MediCage cervical" ha sido desarrollado para la fusión intercorporeal en la columna vertebral cervical. Su diseño abierto proporciona un espacio óptimo para el relleno de hueso esponjoso y una amplia superficie para la fusión ósea. La forma cónica del cajetín permite restablecer el perfil lordótico. El implante se halla disponible en distintos tamaños para garantizar su aplicación universal.

Le "MediCage cervical" a été mis au point pour la fusion intercorporelle au niveau de la colonne vertébrale cervicale. Sa conception ouverte offre un espace optimal pour le comblement de l'os spongieux et une surface étendue pour la consolidation osseuse. Sa forme conique permet de rétablir le profil lordotique. Afin de garantir une application universelle, l'implant est disponible dans différentes tailles.

Il "MediCage cervical" è stato sviluppato per la fusione intercorporeale della colonna vertebrale cervicale. Il design aperto offre spazio ottimale per il riempimento con spongiosa e una superficie grande per la fusione ossea. La forma conica del cage consente il ripristino del profilo lordotico. Per garantire un'applicazione universale l'impianto è disponibile in diverse misure.



Implantate für die thorakale Wirbelsäule
Implants for the Thoracic Spine
Implantes para la columna vertebral dorácica
Implants pour la colonne vertébrale thoracique
Impianti per la colonna vertebrale toracica

C04



451.04.65

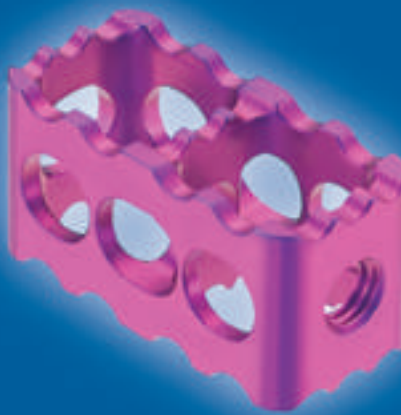
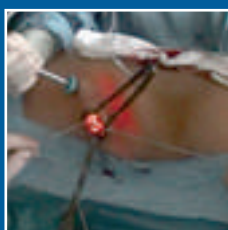

mediCage
Thoracal

Der "MediCage-thoracal" wurde zur interkorporellen Fusion an der thorakalen Wirbelsäule entwickelt. Sein offenes Design bietet optimalen Raum zum Auffüllen von Spongiosa und eine große Fläche für die knöchernen Durchbauung. Zur Gewährleistung einer universellen Anwendung ist das Implantat in verschiedenen Größen erhältlich.

The "MediCage thoracal" was developed for intercorporeal fusion on the thoracic spine. Its open design provides best possible space for spongiosa filling and a large area for ossification. The implant is available in different sizes to allow universal application.

El "MediCage thoracal" ha sido desarrollado para la fusión intercorporeal en la columna vertebral torácica. Su diseño abierto proporciona un espacio óptimo para el relleno de hueso esponjoso y una amplia superficie para la fusión ósea. El implante se halla disponible en distintos tamaños para garantizar su aplicación universal.

Le "MediCage thoracal" a été mis au point pour la fusion intercorporelle au niveau de la colonne vertébrale thoracique. Sa conception ouverte offre un espace optimal pour le comblement de l'os spongieux et une surface étendue pour la consolidation osseuse. Afin de garantir une application universelle, l'implant est disponible dans différentes tailles.

Il "MediCage thoracal" è stato sviluppato per la fusione intercorporeale della colonna vertebrale toracica. Il design aperto offre spazio ottimale per il riempimento con spongiosa e una superficie grande per la fusione ossea. Per garantire un'applicazione universale l'impianto è disponibile in diverse misure.



Weitere Informationen finden Sie in unserem Sonderprospekt.
 For further information please see our special brochure.
 Informaciones adicionales se encuentran en nuestro folleto especial.
 Vous trouverez de plus amples informations dans notre prospectus spécial.
 Troverete più informazioni nel nostro depliant speciale.

C05
Pedikelschraubensystem zur Stabilisierung der Wirbelsäule
Pedicle Screw System for Stabilising the Spine
Sistema de tornillos pediculares para estabilizar la columna vertebral
Système de vis pédiculaire destiné à stabiliser la colonne vertébrale
Sistema di viti peduncolari per la stabilizzazione della colonna vertebrale

mediRod® Tri

OPEN

PERCUTANEOUS

PERCUTANEOUS ISK

In situ komplettierbar (ISK)
 Completion in situ (ISK)
 Se puede completar in situ (ISK)
 Peut être complété in situ (ISK)
 Completabile in situ (ISK)



Für offene und vor allem aber für perkutane Zugangs-
 techniken an der thorakalen und lumbalen Wirbelsäule
 mit der Möglichkeit, den polyaxialen Kopf nach erfolgter
 transtubulärer Spinalkanaldekompensation auf die initial
 eingebrachte kanülierte Pedikelschraube aufzusetzen.
 Über die gleiche Stichinzision zur Schraubenimplan-
 tation kann die Dekompensation und ein TLIF
 durchgeführt werden.

For open approach techniques but primarily for
 percutaneous approach techniques on the thoracic and
 lumbar spine with the option of placing the polyaxial
 head onto the initially inserted cannulated pedicle
 screw after carrying out the transtubular spinal canal
 decompression. The decompression and a TLIF can be
 inserted through the same stab incision.

Para técnicas de acceso abiertas y, sobre todo,
 percutáneas en la columna vertebral dorácica y lumbar,
 con posibilidad de colocar la cabeza poliaxial en el
 tornillo pedicular canulado e inicialmente introducido,
 después de realizar la descompresión transtubular del
 canal espinal. A través de la misma incisión para la
 implantación de tornillos se pueden realizar la
 descompresión y una TLIF.

Pour techniques d'accès ouvertes mais aussi et surtout
 pour les techniques d'accès percutanées au niveau de
 la colonne vertébrale thoracique et lombaire avec
 possibilité de poser la tête polyaxiale sur la vis
 pédiculaire canulée préalablement insérée après
 décompression transtubulaire du canal spinal. La
 décompression ainsi qu'une TLIF peuvent être réalisées
 via la même incision que celle réalisée pour
 l'implantation de la vis.

Per tecniche miniaturizzate aperte e soprattutto per
 quelle percutanee alla colonna vertebrale toracica e
 lombare con la possibilità di applicare la testa
 poliassiale a seguito di decompressione del canale
 vertebrale transtubulare sulla vite del peduncolo
 canalizzata inizialmente inserita. Mediante la stessa
 incisione a pressione all'impianto a vite è possibile
 eseguire la decompressione e un TLIF.

Pedikelschraubensystem zur Stabilisierung der Wirbelsäule
Pedicle Screw System for Stabilising the Spine
Sistema de tornillos pediculares para estabilizar la columna vertebral
Système de vis pédiculaire destiné à stabiliser la colonne vertébrale
Sistema di viti peduncolari per la stabilizzazione della colonna vertebrale

C05

Positionieren ⇒ Pedikel öffnen ⇒ Schraube einbringen
 Positioning ⇒ Pedicle opening ⇒ Screw insertion
 Posicionar ⇒ Abrir el pedículo ⇒ Introducir el tornillo
 Positionnement ⇒ Ouverture du pédicule ⇒ Pose de la vis
 Posizionamento ⇒ Peduncolo aperto ⇒ Applicazione di vite



Zeitersparnis
 Time saving
 Ahorro de tiempo
 Gain de temps
 Risparmio di tempi



Kanülierte Pedikelschraube mit integriertem Bohrer
 Cannulated pedicle screw with integrated drill
 Tornillo pedicular canulado con broca integrada
 Vis pédiculaire canulée avec fraise intégrée
 Vite del peduncolo canalizzata con fresa integrata



Keine KIRSCHNER-Drähte notwendig ⇒ Kein Migrationsrisiko
 No KIRSCHNER wires necessary ⇒ No migration risk
 El uso de brocas de KIRSCHNER no es necesario ⇒ Ni riesgo de migración
 Aucune broche de KIRSCHNER nécessaire ⇒ Aucun risque de migration
 Non si ha bisogno di fili di KIRSCHNER ⇒ Nessun rischio di migrazione



Geringe Röntgenbelastung
 Reduced X-ray exposure
 Mínima exposición a los rayos X
 Faible exposition aux rayons X
 Ridotto l'esposizione ai raggi X



medicon® courses

Unsere Medicon-Kurse im Bereich der Wirbelsäulenchirurgie bieten eine Plattform des wissenschaftlichen Austausches in Kombination mit praxisnahen Anwendungen an ausgesuchten Operationsfällen.

Our Medicon training courses on spinal surgery provide a platform for an interchange of scientific ideas combined with practical application scenarios of selected surgical cases.

Los cursos de Medicon en el campo de la cirugía de la columna vertebral ofrecen una plataforma para el intercambio científico en combinación con aplicaciones prácticas en casos operatorios seleccionados.

Nos cours Medicon dans le domaine de la chirurgie rachidienne offrent une plateforme d'échange scientifique combinée à des applications pratiques de cas d'opération sélectionnés.

I corsi Medicon nel settore della chirurgia della colonna vertebrale offrono una piattaforma degli scambi scientifici abbinati agli impieghi pratici su casi operatori selezionati.

Weitere Informationen:
Further information:
Más informaciones:
Plus d'informations:
Più informazioni:

<http://courses.medicon.de>



Siebvorschläge
Set Suggestions
Proposiciones de juegos
Propositions pour boîtes
Proposte di set

D

neuro
SPINALIS

Siebvorschläge
Set Suggestions
Proposiciones de juegos
Propositions pour boîtes
Proposte di set

D01	Siebvorschlag für die spinale Mikrochirurgie Set suggestion for spinal microsurgery Proposición de juego para microcirugía espinal Proposition de boîte de microchirurgie spinale Proposta di set per la microchirurgia spinale	333
D02	Siebvorschlag für Operationen an der Halswirbelsäule Set suggestion for surgery of the cervical spine Proposición de juego para la cirugía de la columna vertebral cervical Proposition de boîte pour la chirurgie du colonne vertébrale cervical Proposta di set per la chirurgia della colonna vertebrale cervicale	334
D03	Siebvorschlag für Operationen an der thorakalen und lumbalen Wirbelsäule Set Suggestion for Surgery of the thoracic and lumbar spine Proposición de juego para la cirugía de la columna vertebral torácica y lumbar Proposition à boîte pour la chirurgie du colonne vertébrale thoracique et lombaire Proposta di set per la chirurgia della colonna vertebrale toracica e lombare	338

Siebvorschlag für die spinale Mikrochirurgie
Set Suggestion for Spinal Microsurgery
Proposición de juego para microcirugía espinal
Proposition à boîte de microchirurgie spinale
Proposta di set per la microchirurgia spinale

D01



Item number	Description	Quantity
09.83.76	FRAZIER (FERGUSSON) Suction cannula · angled · 6 French · 18 cm	1
58.19.27	YASARGIL Micro scissors · angled · buttoned · 18 cm	1
58.30.01	JACOBSON Vessel knife · 18.5 cm	1
58.30.10	YASARGIL Raspatory · angled · 1 mm · 18.5 cm	1
58.30.17	YASARGIL Raspatory · slightly curved · 2.5 mm · 18.5 cm	1
58.30.20	JACOBSON Probe · ball tip · angled · 18.5 cm	1
58.30.32	KRAYENBÜHL Hook · 3.5 mm · 18.5 cm	1
58.30.35	KRAYENBÜHL Hook · 2.0 mm · 18.5 cm	1
58.30.36	KRAYENBÜHL Hook · 2.5 mm · 18.5 cm	1
58.32.04	Hook · sharp · 2.5 mm · 18.5 cm	1
58.32.21	Micro dissector · 1.0 mm · 23 cm	1
58.32.22	Micro dissector · 1.4 mm · 23 cm	1
58.32.23	Micro dissector · 1.8 mm · 23 cm	1
58.33.35	SAMII Tumor knife · 3.0 mm · 23 cm	1
58.33.42	SAMII Tumor knife · Ø 3.0 mm · 23 cm	1
59.20.20	YASARGIL Micro scissors · bayonet · straight · 20 cm	1
59.20.21	YASARGIL Micro scissors · bayonet · curved · 20 cm	1
59.23.10	YASARGIL Micro forceps · bayonet · sharp · 0.6 mm · 23 cm	1
59.23.14	YASARGIL Micro forceps · bayonet · blunt · 0.9 mm · 23 cm	1
49.50.10	Medicontainer · silver · 290 × 290 × 100 mm	1
49.97.02	Wire basket · 240 × 255 × 50 mm	2
49.97.72	Silicon mat · distance between naps 3 mm · 240 × 220 mm	2

**Siebvorschlag für Operationen an der Halswirbelsäule****Set Suggestion for Surgery of the Cervical Spine****Proposición de juego para la cirugía de la columna vertebral cervical****Proposition à boîte pour la chirurgie du colonne vertébrale cervical****Proposta di set per la chirurgia della colonna vertebrale cervicale****D02****PART 1**

Item number	Description	Quantity
01.27.03	Scalpel handle · no 3 · standard · 12.5 cm	1
01.27.07	Scalpel handle · no 7 · long · 16.5 cm	1
01.28.04	Scalpel handle · no 4 · standard · 13.5 cm	1
03.07.84	Operating scissors · delicate · curved · sharp / blunt · 14.5 cm	1
03.50.17	MAYO Scissors · straight · 17 cm	1
03.57.96	LEXER "HM" Scissors · curved · 16 cm	1
04.35.68	METZENBAUM "HM" Scissors · slim · curved · 18 cm	1
04.35.70	METZENBAUM "HM" Scissors · slim · curved · 20 cm	1
06.23.15	MICRO-ADSON Tissue forceps · 1 × 2 teeth · 15 cm	1
06.40.85	GILLIES Tissue forceps · 1 × 2 teeth · 15 cm	2
06.46.18	POTTS-SMITH Dressing forceps · serrated · 18 cm	1
06.48.18	POTTS-SMITH Tissue forceps · 1 × 2 teeth · 18 cm	2
06.60.90	GERALD Dressing forceps · serrated · straight · 18 cm	1
07.31.19	GRUENWALD Bayonet forceps · 1 × 2 teeth · 19.5 cm	1
09.60.10	REDON Guide needle · slight curved · knife tip · threaded end · 10 French	1
09.82.30	FRAZIER Suction cannula · straight · 10 French · 12.5 cm	2
09.83.80	FRAZIER (FERGUSON) Suction cannula · angled · 10 French · 18 cm	1
09.83.82	FRAZIER (FERGUSON) Suction cannula · angled · 12 French · 18 cm	1
10.20.64	BABY-CRILE-WOOD "HM" Needle holder · 15 cm	1
10.20.68	CRILE-WOOD "HM" (DEBAKEY "HM") Needle holder · 18 cm	1
10.20.73	CRILE-WOOD "HM" (DEBAKEY "HM") Needle holder · 23 cm	1
11.18.70	MATHIEU-KOCHER "HM" Needle holder · 20 cm	1
15.45.12	HALSTED-MOSQUITO Forceps · curved · 12.5 cm	5
16.12.20	ROCHESTER-OCHSNER Hemostatic forceps · 1 × 2 teeth · straight · 20 cm	1



Siebvorschlag für Operationen an der Halswirbelsäule
Set Suggestion for Surgery of the Cervical Spine
Proposición de juego para la cirugía de la columna vertebral cervical
Proposition à boîte pour la chirurgie du colonne vertébrale cervical
Proposta di set per la chirurgia della colonna vertebrale cervicale

D02

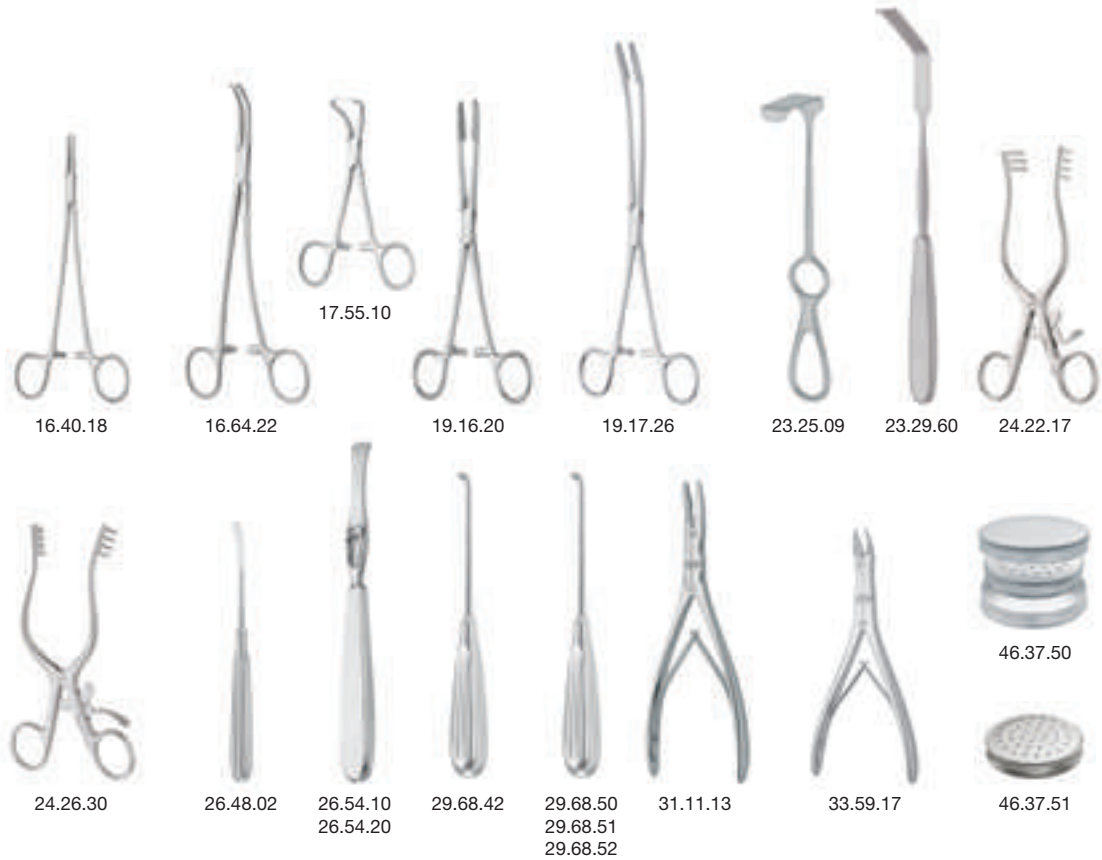

PART 2

Item number	Description	Quantity
16.40.18	HALSTED (ADSON) Hemostatic forceps · straight · 18 cm	2
16.64.22	OVERHOLT-SLIM Forceps · 21.5 cm	1
17.55.10	BACKHAUS Towel clamp · 10.5 cm	10
19.16.20	GROSS Dressing forceps · straight · 20 cm	4
19.17.26	MAIER Dressing forceps · curved · 26 cm	2
23.25.09	LANGENBECK-KOCHER Retractor · 20 × 45 mm · 21 cm	2
23.29.60	ZENKER Retractor · 12 × 60 mm · 26 cm	2
24.22.17	WEITLANER Retractor · 3 × 4 teeth · blunt · 16.5 cm	1
24.26.30	MOLLISON Retractor · 4 × 4 teeth · sharp · 17 cm	2
26.48.02	ADSON Elevator · slightly curved · blunt · 6 mm · 17 cm	1
26.54.10	LAMBOTTE Raspatory · 10 mm · 22 cm	1
26.54.20	LAMBOTTE Raspatory · 20 mm · 22 cm	1
29.68.42	DAUBENSPECK Sharp curette · figure 00 · 20 cm	1
29.68.50	DAUBENSPECK Sharp curette · figure 0 · 20 cm	1
29.68.51	DAUBENSPECK Sharp curette · figure 1 · 20 cm	1
29.68.52	DAUBENSPECK Sharp curette · figure 2 · 20 cm	1
31.11.13	MARQUARDT Bone rongeur · curved · 20 cm	1
33.59.17	MCINDOE Bone cut forceps · curved · 18 cm	1
46.37.50	Needle case · Ø 65 mm	1
46.37.51	Inner case only for 46.37.50	1



**Siebvorschlag für Operationen an der Halswirbelsäule****Set Suggestion for Surgery of the Cervical Spine****Proposición de juego para la cirugía de la columna vertebral cervical****Proposition à boîte pour la chirurgie du colonne vertébrale cervicale****Proposta di set per la chirurgia della colonna vertebrale cervicale****D02**57.23.02
57.23.03
57.23.12

57.28.33

57.30.21
57.30.22

57.36.14



57.49.10



57.49.26



57.58.60



58.47.01



59.24.14



49.60.22

49.97.21
49.97.22**PART 3**

Item number	Description	Quantity
57.23.02	CASPAR Rongeur · straight · 2 x 10 mm · 15.5 cm	1
57.23.03	CASPAR Rongeur · straight · 3 x 10 mm · 15.5 cm	1
57.23.12	CASPAR Rongeur · angled upwards 30° · 2 x 10 mm · 15.5 cm	1
57.28.33	KERRISON Rongeur · dismantable · angled upwards 40° · 3 mm · 20 cm	1
57.30.21	KERRISON Rongeur · dismantable · angled upwards 40° · 1 mm · 18 cm	1
57.30.22	KERRISON Rongeur · dismantable · angled upwards 40° · 2 mm · 18 cm	1
57.36.14	DAVIS Dissector · double-ended · 4 mm / 5 mm · 25 cm	1
57.49.10	EIF Hook · 90° · sharp · 24 cm	1
57.49.26	GRONINGEN Nerve hook · 90° · 26 cm	1
57.58.60	Spreading system "CERVICALINO" with joint · set complete with PEEK blades	1
58.47.01	CASPAR Exploration hook · 24.5 cm	1
59.24.14	YASARGIL Micro forceps · bayonet · blunt · 0.9 mm · 24 cm	1
49.60.22	Medicontainer · silver · 590 x 290 x 220 mm	1
49.97.21	Wire basket · 510 x 255 x 50 mm	1
49.97.22	Wire basket · 510 x 255 x 70 mm	2



Siebvorschlag für Operationen an der Halswirbelsäule
Set Suggestion for Surgery of the Cervical Spine
Proposición de juego para la cirugía de la columna vertebral cervical
Proposition à boîte pour la chirurgie du colonne vertébrale cervical
Proposta di set per la chirurgia della colonna vertebrale cervicale

D02

Optionale Instrumente zum Setzen von Implantaten
Optional instruments for placement of implants
Instrumentos opcionales para la colocación de los implantes
Instruments optionnels pour la pose d'implants
Strumenti opzionali per il posizionamento degli impianti



PART 4

Item number	Description	Quantity
27.95.15	CASPAR Pestle · Ø 3 mm · 20 cm	1
27.95.16	CASPAR Pestle · Ø 5 mm · 20 cm	1
57.55.11	Drilling sleeves for left side access · 21.5 cm	1
57.55.13	Drilling sleeves for right side access · 21.5 cm	1
57.55.14	Vertebral distraction devices for left side access	1
57.55.15	Vertebral distraction devices for right side access	1
57.55.18	Twist drill · Ø 1.7 mm · 13 mm · 14.5 cm	1
57.55.19	Screwdriver · 20 cm	1
57.55.22	Distraction screws · Ø 3.5 mm · 16 mm · 14.5 cm	4



D03

Siebvorschlag für Operationen an der thorakalen und lumbalen Wirbelsäule
Set Suggestion for Surgery of the Thoracic and Lumbar Spine
Proposición de juego para la cirugía de la columna vertebral torácica y lumbar
Proposition à boîte pour la chirurgie du colonne vertébrale thoracique et lombaire
Proposta di set per la chirurgia della colonna vertebrale toracica e lombare

**PART 1**

Item number	Description	Quantity
01.27.03	Scalpel handle · no 3 · standard · 12.5 cm	1
01.28.04	Scalpel handle · no 4 · standard · 13.5 cm	2
03.07.84	Operating scissors · delicate · curved · sharp / blunt · 14.5 cm	1
03.50.17	MAYO Scissors · straight · 17 cm	1
03.51.17	MAYO Scissors · curved · 17 cm	1
04.35.68	METZENBAUM "HM" Scissors · slim · curved · 18 cm	1
04.35.70	METZENBAUM "HM" Scissors · slim · curved · 20 cm	1
06.05.18	Tissue forceps · 1 × 2 teeth · standard · 18 cm	1
06.23.15	MICRO-ADSON Tissue forceps · 1 × 2 teeth · 15 cm	1
06.40.85	GILLIES Tissue forceps · 1 × 2 teeth · 15 cm	2
06.46.18	POTTS-SMITH Dressing forceps · serrated · 18 cm	2
06.48.18	POTTS-SMITH Tissue forceps · 1 × 2 teeth · 18 cm	1
07.31.19	GRUENWALD Bayonet forceps · 1 × 2 teeth · 19.5 cm	2
09.60.10	REDON Guide needle · slight curved · knife tip · threaded end · 10 French	1
09.82.30	FRAZIER Suction cannula · straight · 10 French · 12.5 cm	1
09.83.34	FRAZIER (FERGUSON) Suction cannula · angled · 15 French · 16 cm	1
09.83.80	FRAZIER (FERGUSON) Suction cannula · angled · 10 French · 18 cm	1
09.83.82	FRAZIER (FERGUSON) Suction cannula · angled · 12 French · 18 cm	1
10.18.65	MAYO-HEGAR "HM" Needle holder · fine · 15 cm	1
10.20.68	CRILE-WOOD "HM" (DEBAKEY "HM") Needle holder · 18 cm	1
10.20.70	CRILE-WOOD "HM" (DEBAKEY "HM") Needle holder · 20 cm	1
11.22.70	MATHIEU "HM" Needle holder · 20 cm	1
15.47.12	HALSTED-MOSQUITO Forceps · curved · 1 × 2 teeth · 12.5 cm	12



Siebvorschlag für Operationen an der thorakalen und lumbalen Wirbelsäule
Set Suggestion for Surgery of the Thoracic and Lumbar Spine
Proposición de juego para la cirugía de la columna vertebral torácica y lumbar
Proposition à boîte pour la chirurgie du colonne vertébrale thoracique et lombaire
Proposta di set per la chirurgia della colonna vertebrale toracica e lombare

D03

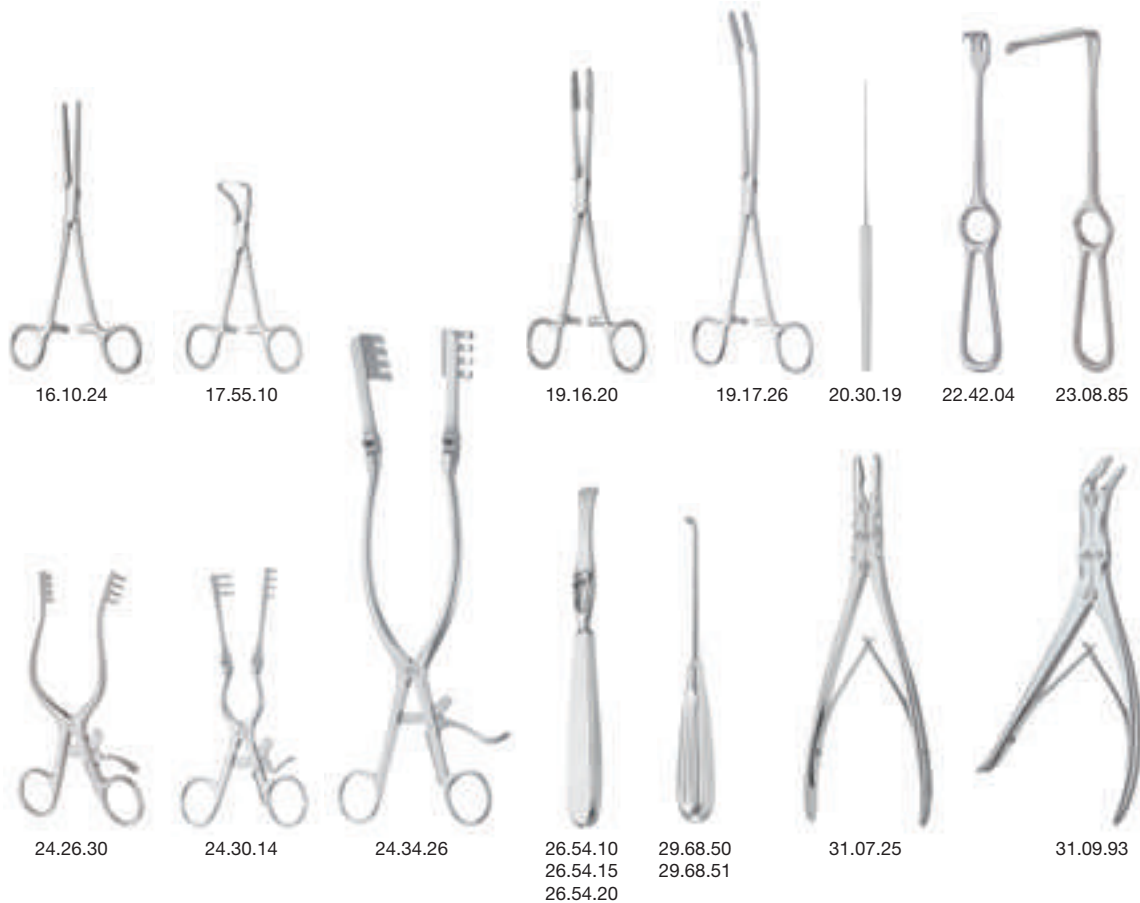

PART 2		Item number	Description	Quantity
		16.10.24	ROCHESTER-PEAN Hemostatic forceps · straight · 24 cm	2
		17.55.10	BACKHAUS Towel clamp · 10.5 cm	6
		19.16.20	GROSS Dressing forceps · straight · 20 cm	4
		19.17.26	MAIER Dressing forceps · curved · 26 cm	4
		20.30.19	GILLIES Hook · small · 19 cm	1
		22.42.04	KOCHER Retractor · 4 teeth · sharp · 18 mm · 22 cm	2
		23.08.85	LANGENBECK Retractor · 15 × 85 mm · 21 cm	1
		24.26.30	MOLLISON Retractor · 4 × 4 teeth · sharp · 17 cm	2
		24.30.14	WEITLANER-BECKMANN Retractor · blunt · 14.5 cm	1
		24.34.26	BECKMANN-ADSON Retractor · blunt · 25 mm · 31 cm	1
		26.54.10	LAMBOTTE Raspatory · 10 mm · 22 cm	1
		26.54.15	LAMBOTTE Raspatory · 15 mm · 22 cm	1
		26.54.20	LAMBOTTE Raspatory · 20 mm · 22 cm	1
		29.68.50	DAUBENSPECK Sharp curette · figure 0 · 20 cm	1
		29.68.51	DAUBENSPECK Sharp curette · figure 1 · 20 cm	1
		31.07.25	RUSKIN Bone rongeur · curved · 5 mm · 24 cm	1
		31.09.93	Bone rongeur · slender pattern · angled sideways · 23 cm	1





Siebvorschlag für Operationen an der thorakalen und lumbalen Wirbelsäule
Set Suggestion for Surgery of the Thoracic and Lumbar Spine
Proposición de juego para la cirugía de la columna vertebral torácica y lumbar
Proposition à boîte pour la chirurgie du colonne vertébrale thoracique et lombaire
Proposta di set per la chirurgia della colonna vertebrale toracica e lombare

D03

33.71.27



57.23.02
57.23.03
57.23.04
57.23.05
57.23.12
57.23.13



57.28.02
57.28.03
57.28.04
57.28.05



57.36.14



57.54.16



58.33.38

58.47.01
58.47.03

49.60.17



49.97.12

PART 3

Item number	Description	Quantity
33.71.27	LISTON-STILLE Bone forceps · curved · 28 cm	1
57.23.02	CASPASPAR Rongeur · straight · 2 x 14 mm · 15.5 cm	1
57.23.03	CASPASPAR Rongeur · straight · 3 x 14 mm · 15.5 cm	1
57.23.04	CASPASPAR Rongeur · straight · 4 x 14 mm · 15.5 cm	1
57.23.05	CASPASPAR Rongeur · straight · 5 x 14 mm · 15.5 cm	1
57.23.12	CASPASPAR Rongeur · angled upwards 30° · 2 x 14 mm · 15.5 cm	1
57.23.13	CASPASPAR Rongeur · angled upwards 30° · 3 x 14 mm · 15.5 cm	1
57.28.02	KERRISON Rongeur · dismantable · angled upwards 40° · 2 mm · 18 cm	1
57.28.03	KERRISON Rongeur · dismantable · angled upwards 40° · 3 mm · 18 cm	1
57.28.04	KERRISON Rongeur · dismantable · angled upwards 40° · 4 mm · 18 cm	1
57.28.05	KERRISON Rongeur · dismantable · angled upwards 40° · 5 mm · 18 cm	1
57.36.14	DAVIS Dissector · double-ended · 4 mm / 5 mm · 25 cm	1
57.54.16	CASPASPAR Nerve root retractor · 6 mm · 24 cm	1
58.33.38	SAMIII Tumor knife · 5 mm · 23 cm	1
58.47.01	CASPASPAR Exploration hook · 4 mm · 24.5 cm	1
58.47.03	CASPASPAR Exploration hook · 7 mm · 24.5 cm	1
49.60.17	Medicontainer · silver · 590 x 290 x 170 mm	1
49.97.12	Wire basket · 480 x 255 x 50 mm	3



Siebvorschlag für Operationen an der thorakalen und lumbalen Wirbelsäule
Set Suggestion for Surgery of the Thoracic and Lumbar Spine
Proposición de juego para la cirugía de la columna vertebral torácica y lumbar
Proposition à boîte pour la chirurgie du colonne vertébrale thoracique et lombaire
Proposta di set per la chirurgia della colonna vertebrale toracica e lombare

D03

Optional: Spreizersystem für die thorakale und lumbale Wirbelsäule
Optional: Spreading system for the thoracic and lumbar spine
Opcional: Sistema de separadores para la columna torácica y lumbar
Optionnel: Système écarteur pour la colonne thoracique et lombaire
Opzionale: Sistema di divaricazione per la colonna vertebrale toracica e lombare

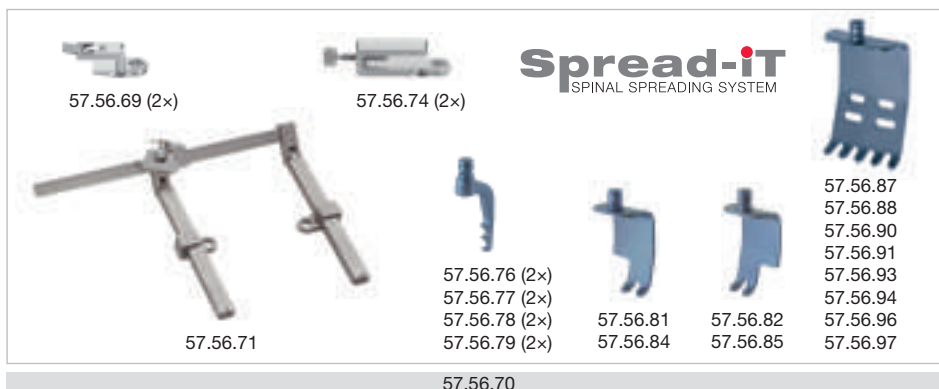

Item number	Description	Quantity
57.56.70	SPREAD-IT Titanium spreading system	1
57.56.98	Handle for insertion of blades · 18 cm	1
57.57.99	Depth gauge · Ø 14 mm · 16.5 cm	1
→ 57.59.79	PEEK Blade · excellent X-ray transparency · 8 teeth · 23 mm · 40 mm	2
→ 57.59.80	PEEK Blade · excellent X-ray transparency · 8 teeth · 23 mm · 45 mm	2
→ 57.59.81	PEEK Blade · excellent X-ray transparency · 8 teeth · 23 mm · 50 mm	2
→ 57.59.82	PEEK Blade · excellent X-ray transparency · 8 teeth · 23 mm · 55 mm	2
→ 57.59.83	PEEK Blade · excellent X-ray transparency · 8 teeth · 23 mm · 60 mm	2
→ 57.59.84	PEEK Blade · excellent X-ray transparency · 8 teeth · 23 mm · 65 mm	2
→ 57.59.85	PEEK Blade · excellent X-ray transparency · 8 teeth · 23 mm · 75 mm	2
49.60.17	Medicontainer · silver · 590 × 290 × 170 mm	1
49.97.21	Wire basket · 510 × 255 × 50 mm	1
49.97.22	Wire basket · 510 × 255 × 70 mm	1
49.97.75	Silicon mat · distance between naps 8 mm · 460 × 240 mm	2



Instrumente, optional
 Instruments optional
 Instrumentos opcional
 Instruments optionnel
 Strumenti opzionale



Siebvorschlag für Operationen an der thorakalen und lumbalen Wirbelsäule
Set Suggestion for Surgery of the Thoracic and Lumbar Spine
Proposición de juego para la cirugía de la columna vertebral torácica y lumbar
Proposition à boîte pour la chirurgie du colonne vertébrale thoracique et lombaire
Proposta di set per la chirurgia della colonna vertebrale toracica e lombare

D03

Optional: Spreizersystem für die lumbale Bandscheibe
Optional: Spreading system for the lumbar intervertebral disc
Opcional: Sistema de separadores para el disco intervertebral lumbar
Optionnel: Système écarteur pour le disque intervertébrale lombaire
Opzionale: Sistema di divaricazione per il disco intervertebrale lombare

**PART 5**

Item number	Description	Quantity
23.20.02	KOCHER Retractor · 12 × 45 mm · 21 cm	1
57.58.35	Speculum for counter-retractor · 40 mm	1
57.58.36	Speculum for counter-retractor · 45 mm	1
57.58.37	Speculum for counter-retractor · 50 mm	1
57.58.38	Speculum for counter-retractor · 55 mm	1
57.58.39	Speculum for counter-retractor · 60 mm	1
57.58.40	Speculum for counter-retractor · 65 mm	1
57.58.42	Speculum for counter-retractor · 75 mm	1
57.57.52	Counter retractor with joint	1
→ 57.60.63	PEEK Blade · semi transparent to X-ray · 12 mm · 40 mm	1
→ 57.60.64	PEEK Blade · semi transparent to X-ray · 12 mm · 45 mm	1
→ 57.60.65	PEEK Blade · semi transparent to X-ray · 12 mm · 50 mm	1
→ 57.60.66	PEEK Blade · semi transparent to X-ray · 12 mm · 55 mm	1
→ 57.60.67	PEEK Blade · semi transparent to X-ray · 12 mm · 60 mm	1
→ 57.60.68	PEEK Blade · semi transparent to X-ray · 12 mm · 65 mm	1
→ 57.60.69	PEEK Blade · semi transparent to X-ray · 12 mm · 75 mm	1
57.60.83	PEEK Blade · excellent X-ray transparency · 8/12 mm · 40 mm	1
57.60.84	PEEK Blade · excellent X-ray transparency · 8/12 mm · 45 mm	1
57.60.85	PEEK Blade · excellent X-ray transparency · 8/12 mm · 50 mm	1
57.60.86	PEEK Blade · excellent X-ray transparency · 8/12 mm · 55 mm	1
57.60.87	PEEK Blade · excellent X-ray transparency · 8/12 mm · 60 mm	1
57.60.88	PEEK Blade · excellent X-ray transparency · 8/12 mm · 65 mm	1
57.60.89	PEEK Blade · excellent X-ray transparency · 8/12 mm · 75 mm	1
68.18.93	DOCKHORN Retractor · 55 × 14 mm · 21 cm	1
49.50.10	Medicontainer · silver · 290 × 290 × 135 mm	1
49.97.02	Wire basket · 240 × 255 × 50 mm	1
49.97.90	Wire basket · 240 × 250 × 40 mm	1



Instrumente, optional
 Instruments optional
 Instrumentos opcional
 Instruments optionnel
 Strumenti opzionale



Alphabetischer und numerischer Index
Alphabetical and Numerical Index
Índice alfabético y numérico
Index alphabétique et numérique
Indice alfabetico e numerico

E

neuro
SPINALIS

Alphabetischer und numerischer Index
Alphabetical and Numerical Index
Índice alfabético y numérico
Index alphabétique et numérique
Índice alfabético e numerico

E01	Alphabetischer Index	DEUTSCH	345
E02	Alphabetical index	ENGLISH	351
E03	Índice alfabético	ESPAÑOL	357
E04	Index alphabétique	FRANÇAIS	363
E05	Índice alfabético	ITALIANO	369
E06	Numerischer Index Numerical index Índice numérico Index numérique Índice numerico		376



A	
ADSON HM Feine Pinzetten	32
ADSON Elevatorium	100
ADSON Feine Pinzetten	32
ADSON Häkchen	283
ADSON JACOBSON Mikro-Pinzetten	40
ADSON MICRO Feine Pinzetten	32
ADSON Raspatorien	102
ADSON Wundspreizer	94, 96
ADSON-ANDERSON Wundspreizer	94
ADSON BECKMANN Wundspreizer	97
Anatomische Pinzetten	32-35
ANDERSON ADSON Wundspreizer	94
Anlegezangen	86
Anschlusskabel bipolar	64
Antihaftpinzetten	57-61
Arbeitsaufsätze	313, 315
Atraumatische Gefäßpinzetten	36-37
Atraumatische Pinzetten	36-39
AUSTIN Nahtpinzette	56

B	
BABY-CRILE-WOOD HM Nadelhalter	70
BABY-CRILE-WOOD Nadelhalter	69
BABY-METZENBAUM Präparierscheren	15
BACON Hohlmeißelzange	130
Bajonettpinzetten	47-53, 60-63
Bajonett-Saugkanülen	83
Bandscheibenrongeure	163
BARRAQUER Mikro-Nadelhalter	73
BAUMGARTNER HM Nadelhalter	67
BECKMANN Wundspreizer	96
BECKMANN-ADSON Wundspreizer	97
BECKMANN-EATON Wundspreizer	98
BECKMANN WEITLANER Wundspreizer	95
BEYER Hohlmeißelzangen	129, 133
BIEMER Mikro-Schere	23
BIER Punktionskanülen	81
BINNER Elektrode	185
Bipolare Antihaf-Pinzetten	57-61
Bipolare Anschlusskabel	64
Bipolare Pinzetten	57-63
Bipolator	170
BÖHM Spongiosaentnahme-Set	303-306
Bohrer	236, 305, 316-318
Bohrhülsen	235
BRUNS Scharfe Löffel	122-124

C	
CASPAR Bandscheibenrongeure	163
CASPAR Dissektoren	287, 289-290

CASPAR Explorationshäkchen	166, 174, 285
CASPAR Gegensperrer	226
CASPAR Haken	206
CASPAR Mikro Dissektoren	166
CASPAR Nervwurzelhaken	162, 279
CASPAR Raspatorien	101
CASPAR Rongeure	189, 265-267
CASPAR Spekula	181, 226
CASPAR Spreizer	206, 216-218
CASPAR Spreizersysteme	206, 216-218, 226
CASPAR Stößel	113
CASPAR Valven	207
CASTROVIEJO HM Mikro-Nadelhalter	72-73
CASTROVIEJO-MICRO Mikro-Nadelhalter	73
CASTROVIEJO Nadelhalter	72
CERVICALINO Spreizersystem	143-150
Chirurgische Pinzetten	32-35
Chirurgische Scheren	10-13
CITELLI Stanzen	258
CLINIC LAHEY Häkchen	284
Clips Titan	85
CLOWARD Laminaspreizer	228
CLOWARD Rongeure	269
CLOWARD Spreizer	222
CLOWARD Spreizersysteme	222
CLOWARD Valven	223
COBB Hohlmeißel	119
COBB Raspatorien	107
Container	320
CONTOUR Wundspreizer	94
COTTLE Hammer	110
CRILE Häkchen	283
CRILE-WOOD HM (DEBAKEY HM) Nadelhalter	69
CRILE-WOOD Nadelhalter	69
CRILE-WOOD BABY HM Nadelhalter	70
CRILE-WOOD BABY Nadelhalter	69
CUSHING (TAYLOR) HM Bajonettpinzette	51
CUSHING (TAYLOR) Bajonettpinzetten	51
CUSHING HM Anatomische Pinzetten	35
CUSHING Dekompressionshaken	279
CUSHING MICRO Rongeure	164, 172, 259
CUSHING Nervhäkchen	273
CUSHING Pinzetten anatomisch/chirurgisch	35
CUSHING Raspatorien	103
CUSHING Rongeure	172, 259, 262

D	
DAHMEN Flachmeißel	115
DAHMEN Hohlmeißel	120-121

**Alphabetischer Index**

Alphabetical Index

Índice alfabético

Index alphabétique

Índice alfabético

DANDY Nervwurzelhaken	276
DAUBENSPECK Scharfe Löffel	126
DEBAKEY AT	
Atraumatische Gefäßpinzetten	36-39
DEBAKEY HM Nadelhalter	69
Dekompressionshaken	279
DENNIS Mikro-Pinzetten	45
Dermabrasionsfräser	318
Diamant-Kugelfräser	316
Diamantmesser	291-293
Diamant-Walzenfräser	316
DIETHRICH HEGEMANN Gefäßscheren	19
Dilatations-Sets	160, 170
Dissektoren	185, 287-290
Dissektoren Mikro	166, 174
Dissektoren Wirbelkörper	287
Distractionsschrauben	236
Distractionssysteme	233-234
Doppelcontainer	320
Draht- und Mesh-Plattenscheren	30
Druckluftmotoren	311-312
Durahäkchen	283

E

EATON BECKMANN Wundspreizer	98
ECHLIN Hohlmeißelzangen	137
EIF Häkchen	275
Elektrode	185
Elevatorien	100
Explorationshäkchen	166, 174, 285

F

Fadenführer	300
Fadengabel	300
Fasspinzetten	52-53
Fasszangen	53
Feine Scheren	10, 14-15
Feine Pinzetten	32-33
Feine Präparierscheren	14-15
FERGUSSON FRAZIER Saugkanülen	82, 170
FERRIS-SMITH Rongeurs	261
FERRIS-SMITH-SPURLING Rongeurs	260
FERRIS-SMITH KERRISON Stanzen	255
FERRIS-SMITH Stanzen	186
FISCH Häkchen	281
Flachmeißel	114-115, 180
Fräser	313, 316-318
Fräser "Flamshape"	317
FRAZIER (FERGUSSON) Saugkanülen	82, 170
FRAZIER Häkchen	284
FRAZIER Saugkanülen	81-82
FREER Elevatorien	100

FREER Raspatorien	100
FRENCH HAUSER Spreizer	210
FRENCH HAUSER Spreizersysteme	210
FRIEDMANN Hohlmeißelzange	129
Führungshülse	305
Fußpedal	319

G

Gefäßhäkchen	275
Gefäßmesser	298-299
Gefäßpinzetten atraumatisch	36-37
Gefäßscheren	19-20
Gegensperrer	154, 226
Gewebespreizer zervikal	228
GILLIES Chirurgische Pinzette	34
GILLIES Häkchen	284
GREENBERG PAR Präparierscheren	14
Griff mit Schnellverschluss	160, 169
GRUENWALD Bajonettpinzetten	51
GRUENWALD LOVE Rongeurs	187, 263

H

HAJEK Stanzen	257
HAJEK-KOFLER Stanze	257
Häkchen	166, 171, 281-285
Häkchen Dura	283
Häkchen Exploration	166, 174, 285
Häkchen Gefäß	275
Häkchen Haut	283
Häkchen Nerv	171, 272-275
Haken	162-163, 171, 271-286
Haken Dekompression	279
Haken Nervwurzelhaken	162-163, 171, 276-279
Haken Spinal	90
Haken Sympathektomie	285
Haken Weichteile	91
Haken Wund	88-91, 280
HALLE Scharfe Löffel	126
HALSEY HM Nadelhalter	67
Haltearme	175-176
Halteklammer	64
Hämmer	110-112
HAUSER-FRENCH Spreizer	210
HAUSER-FRENCH Spreizersysteme	210
Hauthäkchen	2836
HAVERFIELD SCOVILLE Spreizer	213
HAVERFIELD SCOVILLE Spreizersysteme	213
HEGAR MAYO HM Nadelhalter	68
HEGEMANN-DIETHRICH Gefäßscheren	19
HM Ligaturscheren	29
Hohlbohrer	305
Hohlmeißel	116-121

Hohlmeißelzangen	129-137
HUNT Fasspinzette	52
I	
INGE Laminaspreizer	229
Instrumentenkassette	293
J	
JACOBSON HM Mikro-Nadelhalter	74
JACOBSON Fadengabel	300
JACOBSON Gefäßmesser	298
JACOBSON Häkchen	281
JACOBSON Mikro-Nadelhalter	74
JACOBSON Mikro-Pinzetten	43
JACOBSON Mikro-Schere	24
JACOBSON-ADSON Mikro-Pinzetten	40
JAMESON REYNOLDS Präparierscheren	18
JANSEN ZAUFAL Hohlmeißelzange	133
JULIAN HM Nadelhalter	70
JULIAN Nadelhalter	70
Juwelierpinzetten	39, 58-59
K	
Kanüle Punktion	81
Kanüle Saug	80, 82-83, 161, 170, 180
Kassette	320
KERRISON "DieBlauen" Stanzen	165, 173, 239-242
KERRISON (FERRIS-SMITH) Stanzen	255
KERRISON (MICRO) Stanzen	248-254, 256
KERRISON (SCHLESINGER) Stanzen	247
KERRISON (SPURLING) Stanzen	243-246
KERRISON Stanzen	165, 173, 239-242, 258
KERRISON Zerlegbare Stanzen	165, 173, 239-242
KERRISON Zerlegbare Zervikal-Stanzen	242
KEY LISTON Knochensplitterzange	137
KLEINERT-KUTZ Hohlmeißelzangen	129
KLIMA-ROSEGGER Punktionskanüle	81
Knochensplitterzangen	137-138
Knotenschieber	182
KOCHER MATHIEU HM Nadelhalter	71
KOFLER HAJEK Stanze	257
KOOS Gefäßmesser	299
KRÄMER Raspatorien	101
Kraniotome	313
Kraniotomfräser	313
KRAYENBÜHL Häkchen	275
Kugelfräser	316
Küretten	302
KUTZ KLEINERT Hohlmeißelzangen	129

L	
LAHEY-CLINIC Häkchen	284
Laminaspreizer	228-229
LANDOLT Skalpellgriffe	6
LANGENBECK HM Nadelhalter	72
LEKSELL Hohlmeißelzangen	135-136
LEMPERT Hohlmeißelzangen	130
LEMPERT Scharfe Löffel	125
LEXER Flachmeißel	114
LEXER Hohlmeißel	116-118
LEXER MINI Flachmeißel	114
LEXER MINI Hohlmeißel	116
Ligaturscheren	29
LISTON KEY Knochensplitterzange	137
LISTON LITTAUER Knochensplitterzange	138
LISTON RUSKIN Knochensplitterzange	138
LITTAUER-LISTON Knochensplitterzange	138
Löffel (gezahnt)	181
LOVE Nervwurzelhaken	276-278
LOVE-GRUENWALD Rongeurs	187, 263
LOVE-PAPAVERO Nervwurzelhaken	163, 278
LUCAE Nervhäkchen	272
LUER Hohlmeißelzangen	130
LUER STILLE Hohlmeißelzangen	134
M	
MAPN	167-174
MARKHAM-MEYERDING Spreizer	230
MARQUARDT Hohlmeißelzange	133
MATHIEU HM Nadelhalter	71
MATHIEU Nadelhalter	71
MATHIEU-KOCHER HM Nadelhalter	71
MAYO Chirurgische Scheren	13
MAYO-HEGAR HM Nadelhalter	68
MCINDOE Anatomische Pinzette	34
MCINDOE Knochensplitterzangen	138
MEDICON Haltearm	176
Meißel Flach	114-115, 178
Meißel Hohl	116-121
Mesh-Plattenscheren	30
Messer Diamant	292-293
METZENBAUM Präparierscheren	16
METZENBAUM BABY Präparierscheren	15
METZENBAUM-SLIM Präparierscheren	17
MEYERDING MARKHAM Spreizer	230
MEYERDING Wundhaken	89
MEYERDING-SCOVILLE Valven	215
MICRO 2000 Mikro-Nadelhalter	76, 78
MICRO 2000 Nahtpinzetten	54-56
MICRO 2000 Pinzetten	40-42, 48, 54-56
MICRO 2000 Scheren	21, 26
MICRO-ADSON Feine Pinzetten	32

**Alphabetischer Index**

Alphabetical Index

Índice alfabético

Index alphabétique

Índice alfabético

MICRO CASTROVIEJO Mikro-Nadelhalter	73
MICRO-CUSHING Rongeurs	164, 172, 259
MICRODISC-XS	157-166
Mikrodissektomie	158-166
Mikro Dissektoren	166, 174
Mikro-Fadenführer	300
Mikro-Fadengabel	300
Mikro-Gefäßmesser	298-299
Mikro-Instrumente	295-302
MICRO KERRISON Stanzen	248-254, 256
Mikro Küretten	302
Mikro-Löffel	301-302
Mikro-Nadel	301
Mikro-Nadelhalter	72-78
Mikro-Nadelhalter Titan	77
Mikro-Pinzetten	39-50
Mikro-Pinzetten Titan	44, 46
Mikro-Raspatorien	295-297
Mikro-Rongeurs	164, 172, 259
Mikro-Scheren	20-28, 161, 174
Mikroscheren MICRO 2000	21, 26
Mikroscheren Flachgriff	22-28
Mikroscheren Rundgriff	20, 22, 24
Mikroscheren Vannas	20, 23, 28
Mikro-Tumormesser	297-298
MILLESÍ Mikro-Schere	24
Miniaturisierte Mikrodissektomie	158-166
MINI RUSKIN Hohlmeißelzangen	131
MINI-LEXER Flachmeißel	114
MINI-LEXER Hohlmeißel	116
MINI-RYDER HM Nadelhalter	70
MISKIMON Wundspreizer	93
Motor mit INTRA-Kupplung	311
Motorschlauch	319
Motorschmiermittel	320
MÜHLING Raspatorien	101
N	
Nadel	301
Nadelhalter	65-78, 190
Nadelhalter MICRO 2000	76, 78
Nadelhalter Mikro	72-78
Nadelhalter Titan	77
Nahtpinzetten	54-56
NEIVERT HM Nadelhalter	67
Nervhäkchen	171, 272-275
Nervwurzelhaken	162-163, 171, 276-279
Neurofräser	317
NICOLA Micro-schere	161, 174
O	
OBWEGESER Weichteilhaken	91

OLDBERG Rongeurs	264
P	
PAPAVERO LOVE Nervwurzelhaken	163, 278
PAPAVERO Saugkanülen	161
PEEK Spreizersystem	203-205
PEN Saugkanülen	79-80
PETERSEN SMITH Hohlmeißelzangen	132
PICCOLINO Spreizersystem	151-156
Pinzette für Valvenwechsel	197, 200, 207, 221
Pinzetten	31-63, 197
Pinzetten anatomisch	32-35
Pinzetten antihaft	57-61
Pinzetten atraumatisch	36-39
Pinzetten Bajonett	47-53, 60-63
Pinzetten bipolar	58-63
Pinzetten bipolar antihaft	57-64
Pinzetten chirurgisch	32-35
Pinzetten fass	52-53
Pinzetten fein	32-33
Pinzetten Gefäß	36-37
Pinzetten HM	32, 35, 51
Pinzetten Juwelier	39, 58-59
Pinzetten mikro	39-50
Pinzetten MICRO 2000	40-42, 48, 54-56
Pinzetten Mikro Titan	44, 46
Pinzetten Naht	54-56
Plattenscheren	30
POTTS-SMITH Gefäßscheren	19-20
POTTS-SMITH	
Pinzetten anatomisch/chirurgisch	34
POTTS-YASARGIL Mikro-Schere	24
Präparierscheren	14-18
Punktionskanülen	81
Q	
QUINCKE Punktionskanülen	81
R	
Raspatorien	100-108, 179, 295-297
Reinigungs-Tray	320
RETRACT Spreizersystem	201-205
REYNOLDS (JAMESON) Präparierscheren	18
RHOTON Dissektoren	288
RHOTON Häkchen	282
RHOTON Nadel	301
RHOTON Raspatorien	296
RHOTON Scharfe Löffel	301
Rongeurs	163-164, 172, 187-189, 259-270
Rongeurs Bandscheiben	163
Rongeurs Mikro	164, 172, 259



ROSEGGER KLIMA Punktionskanüle	81
Rosenbohrer	316
RUSKIN Hohlmeißelzangen	131-132
RUSKIN-LISTON Knochensplitterzangen	138
RUSKIN-MINI Hohlmeißelzangen	131
RYDER MINI HM Nadelhalter	70

S	
SAMII Tumormesser	298
Saug- und Spülinstrumente	80-83
Saugkanülen	80, 82-83, 161, 170, 180
Saugrohre	182
Scharfe Löffel	122-127, 301-302
Scheren	7-30, 190
Scheren chirurgisch	10-13
Scheren Draht- und Mesh-Platten	30
Scheren fein	10, 14-15
Scheren Gefäß	19-20
Scheren Ligatur HM	29
Scheren Mikro	20-28, 161, 174
Scheren MICRO 2000	21, 26
Scheren Mesh-Platten	30
Scheren Präparier	14-18
Scheren Tumor	22
Schläuche	319
SCHLESINGER KERRISON Stanzen	247
SCHLESINGER Rongeurs	269
Schraubendreher	236
SCOVILLE Haken	214
SCOVILLE-HAVERFIELD Spreizersystem	213
SCOVILLE MEYERDING Valven	215
SCOVILLE Nervwurzelhaken	277
SCOVILLE Scharfe Löffel	127
SCOVILLE Spreizersystem	212
SCOVILLE Valven	215
SEDILLOT Raspatorien	102
SELECT Feine Pinzetten	33
SEMB-STILLE Hohlmeißelzangen	134
SEMKEN Feine Pinzetten	33
SHEA Präparierschere	14
SIDE-LOAD Spreizer	224
Skalpelle	3-6
Skalpellgriffe	4-6
Skalpellschlingen	4-6
SLIM METZENBAUM Präparierscheren	17
SLIM Präparierscheren	15, 17
SMITH FERRIS KERRISON Stanzen	255
SMITH FERRIS Rongeurs	261
SMITH FERRIS Stanzen	186
SMITH POTTS Gefäßscheren	19-20
SMITH POTTS Pinzetten anatomisch/chirurgisch	34

SMITH-PETERSEN Hohlmeißelzangen	132
SMITH FERRIS SPURLING Stanzen	260
SMITHWICK Sympathektomie-Haken	285
Spatel Titan	184
Spekula	155, 183, 226
Spiralbohrer	236, 318
Spongiosaspaltzange	306
Spreizer	146-149, 193, 198, 203-204, 206, 208-213, 216-218, 222, 224
Spreizersysteme	146-156, 193-231
Spreizhülsen	159
Spritzschutz für die Dermabrasion	318
Sprühadapter	320
Spülrohre	315
SPURLING FERRIS SMITH Rongeurs	260
SPURLING KERRISON Stanzen	243-246
SPURLING Rongeurs	188, 264
Stanzen	165, 173, 186, 237-258
STEINBACH Hammer	111
STELLBRINK Hohlmeißelzangen	129
STILLE Hohlmeißelzange	136
STILLE SEMB Hohlmeißelzangen	134
STILLE-LUER Hohlmeißelzangen	134
Stößel	113, 179
STRAIGHT Häkchen	284
Sympathektomie-Haken	285
SYPERT Rongeur	268

T	
TAYLOR CUSHING HM Bajonettpinzette	51
TAYLOR CUSHING Bajonettpinzetten	51
TAYLOR Spinalhaken	90
TAYLOR Valven	214-215
Thorakoskop	182
THORAMIC	177-190
Tiefenlehre	194, 199, 225
Titan-Clips	85
Titan Mikro-Nadelhalter	77
Titan Mikro-Pinzetten	44, 46
Titan-Spatel	184
Titan-Spreizersystem	193-199
TOENNIS HM Nadelhalter	72
TOENNIS Tumorfasszangen	53
Tray	320
Trepanfräser	313
Trepanmotor	312
Trokar	306
Trokarhalter	169
Trokarhülsen	168
Tropfen-Saugkanülen	83
Tumorfasszangen	53



E01

Alphabetischer Index

Alphabetical Index

Índice alfabético

Index alphabétique

Índice alfabético

DEUTSCH

Tumormesser	297-298
Tumorscheren	22
TUOHY Punktionskanülen	81

U

UNIVERSAL Draht- und Mesh-Plattenschere	30
UNIVERSAL HM Draht- und Mesh-Plattenschere	30
Uvula Spatel	286

V

Valven aus Aluminium	209
Valven aus PEEK	150, 155-156, 197, 200, 205, 221
Valven aus Stahl	206-208, 210-220, 222-223, 227
Valven aus Titan	195-196, 199, 220, 225
Valvenaufnahmen	194
VIPAIR Druckluftmotorensystem	307-320

W

WAGNER Raspatorien	108
WAGNER Rongeurs	267-268
WALTER Wundhaken	280
Walzenfräser	316-317
Wandschläuche	319
Weichteilhaken	91
WEITLANER Wundspreizer	92-93
WEITLANER-BECKMANN Wundspreizer	95
Werkzeugkassette	320
WILDE Rongeurs	270
WILLIAMS Spreizer	231
WILLIGER Raspatorien	100
Winkelmotor	314
Wirbelkörperdistraktoren	235
Wirbelkörperdissektoren	287
Wirbelkörperfräser	317
Wirbelsäulenthorakoskop	182
WOOD CRILE HM (DEBAKEY HM) Nadelhalter	69
WOOD CRILE Nadelhalter	69
WOOD CRILE BABY HM Nadelhalter	70
WOOD CRILE BABY Nadelhalter	69
Wundhaken	88-91, 280
Wundspreizer	92-98

Y

YASARGIL Dissektoren	287
YASARGIL Fadenführer	300
YASARGIL Fasspinzetten	52-53
YASARGIL Gefäßmesser	299
YASARGIL Mikro-Nadelhalter	74, 78
YASARGIL Mikro-Pinzetten	47, 49-50

YASARGIL Mikro-Scheren	24, 26-28
YASARGIL POTTS Mikro-Schere	24
YASARGIL Raspatorien	295-297
YASARGIL Saugrohre	82

Z

Zangen anlege	86
Zangen fass	53
Zangen Knochensplitter	137-138
ZAUFAL-JANSEN Hohlmeißelzange	133
Zementbohrer	317
Zerlegbare Stanzen	165, 173, 239-242
Zervikales Wirbelkörper- Distractionssystem	233-236
Zervikal-Gewebespreizer	228



A	
ADSON HM Delicate forceps	32
ADSON Delicate forceps	32
ADSON Elevator	100
ADSON Hooks	283
ADSON JACOBSON Micro forceps	40
ADSON MICRO Delicate forceps	32
ADSON Raspatories	102
ADSON Self-retaining retractor	94, 96
ADSON-ANDERSON Self-retaining retractor	94
ADSON BECKMANN Self-retaining retractor	97
Aluminium blades	209
ANDERSON ADSON Self-retaining retractor	94
Angled motor	314
Applying forceps	86
Aspirating and irrigating instruments	79-83, 161, 170, 180
Atraumatic forceps	36-39
Atraumatic vascular forceps	36-37
AUSTIN Suturing forceps	56
B	
BABY-CRILE-WOOD HM Needle holder	70
BABY-CRILE-WOOD needle holder	69
BABY-METZENBAUM Dissecting scissors	15
BACON Rongeur	130
BARRAQUER Micro needle holder	73
BAUMGARTNER HM needle holder	67
Bayonet forceps	51
Bayonet suction cannula	83
BECKMANN Self-retaining retractor	96
BECKMANN-ADSON Self-retaining retractor	97
BECKMANN-EATON Self-retaining retractor	98
BECKMANN WEITLANER Self-retaining retractor	95
BEYER Rongeurs	129, 133
BIEMER Micro scissors	23
BIER Puncture cannula	81
BINNER Bipolator	183
Bipolar connecting cables	64
Bipolar forceps	57-63
Bipolar non-sticking forceps	57-61
Bipolator	170
Blade supports	194
BÖHM Cancellous bone extraction set	303-306
Bone cutting forceps	137-138
Bracket	64
BRUNS Sharp Curettes	122-124
Burrs	313, 316-318
Burrs "Flameshape"	317
Burrs for dermabrasion	318

C	
Cancellous bone cleaver	306
Cancellous bone extraction set	303-306
Cannulas puncture	81
Cannulas suction	80, 82-83, 161, 170, 182
CASPAR Blades	207
CASPAR Blades	215
CASPAR Counter retractors	226
CASPAR Dissectors	287, 289-290
CASPAR Exploration hooks	166, 174, 285
CASPAR Hooks	206
CASPAR Micro dissectors	166
CASPAR Nerve root retractors	162, 279
CASPAR Pestle	113
CASPAR Raspatories	101
CASPAR Retractors	206, 216-218
CASPAR Rongeurs	189, 265-267
CASPAR Rongeurs for intervertebral discs	163
CASPAR Specula	181, 226
CASPAR Spreading systems	206, 216-218, 226
Cassette	320
CASTROVIEJO HM Micro needle holder	72-73
CASTROVIEJO Needle holder	72
CASTROVIEJO-MICRO Micro needle holder	73
Cement drills	317
Cervical tissue retractor	228
Cervical vertebral body distraction system	233-236
CERVICALINO Spreading system	143-150
Chisels	114-115, 180
CITELLI Rongeurs	258
Cleaning tray	320
CLINIC LAHEY Hooks	284
Clips titanium	85
CLOWARD Blades	223
CLOWARD Lamina retractors	228
CLOWARD Retractors	222
CLOWARD Rongeurs	269
CLOWARD Spreading systems	222
COBB Gouges	119
COBB Raspatories	107
Connecting cables bipolar	64
Container	320
CONTOUR Self-retaining retractor	94
COTTLE Mallet	110
Counter retractors	154, 226
Craniotome burrs	313
Craniotomes	313
CRILE Hooks	283
CRILE-WOOD HM (DEBAKEY HM) Needle holder	69
CRILE-WOOD Needle holder	69
CRILE-WOOD BABY HM Needle holder	70



CRILE-WOOD BABY Needle holder	69
Curettes	302
Curettes (serrated)	181
CUSHING Decompression retractor	279
CUSHING Forceps, dressing/tissue	35
CUSHING HM Dressing forceps	35
CUSHING MICRO Rongeurs	164, 172, 259
CUSHING Nerve hooks	273
CUSHING Raspatories	103
CUSHING Rongeurs	172, 259, 262
CUSHING (TAYLOR) HM Bayonet forceps	51
CUSHING (TAYLOR) Bayonet forceps	51
Cutting burrs, barrel style	317
D	
DAHMEN Chisels	115
DAHMEN Gouges	120-121
DANDY Nerve root retractors	276
DAUBENSPECK Sharp Curettes	126
DEBAKEY AT Atraumatic forceps	36-39
DEBAKEY HM CRILE-WOOD HM Needle holder	69
Decompression retractor	279
Delicate dissecting scissors	14-15
Delicate forceps	32-33
Delicate scissors	10, 14-15
DENNIS Micro forceps	45
Depth gauge	194, 199, 225
Diamon cutting burrs, barrel style	316
Diamond dust burrs	316
Diamond knives	292-293
DIETHRICH HEGEMANN Vascular scissors	19
Dilatation sets	160, 170
Dismantable Rongeurs	165, 173, 239-242
Dissecting scissors	14-18
Dissectors	185, 287-290
Dissectors micro	166, 174
Dissectors vertebral body	287
Distraction screws	236
Distratation systems	233-234
Double container	320
Dressing forceps	32-35
Drilling sleeves	235
Drills	236, 305, 316-318
"Drop shape design" Suction cannulas	83
Dura hooks	283
Dura scissors	29
E	
EATON BECKMANN Self-retaining retractor	98
ECHLIN Rongeurs	137
EIF Hooks	275

Electrode	185
Elevators	99-100
Exploration hooks	166, 174, 285
F	
FERGUSSON FRAZIER Suction cannulas	82, 170
FERRIS-SMITH Rongeurs	261, 186
FERRIS-SMITH-SPURLING Rongeurs	260
FERRIS-SMITH KERRISON Rongeurs	255
FISCH Hooks	281
Foot switch	319
Forceps	31-63, 197
Forceps applying	86
Forceps HM	32, 35, 51
Forceps atraumatic	36-39
Forceps bayonet	47-53, 60-63
Forceps bipolar	58-63
Forceps bipolar non-sticking	57-64
Forceps bone cutting	137-138
Forceps delicate	32-33
Forceps dressing	32-35
Forceps for changing the blades	197, 200, 207, 221
Forceps grasping	52-53, 187
Forceps jeweler's	39, 58-59
Forceps MICRO 2000	40-42, 48, 54-56
Forceps micro	39-50
Forceps micro titanium	44, 46
Forceps non-stick	57-61
Forceps suture	54-56
Forceps tissue	32-35
Forceps vascular	36-37
FRAZIER (FERGUSSON)	
Suction cannulas	82, 170
FRAZIER Suction cannulas	81-82
FRAZIER Hooks	284
FREER Elevators	100
FREER Raspatories	100
FRENCH HAUSER Retractors	210
FRENCH HAUSER Spreading systems	210
FRIEDMANN Bone rongeurs	129
G	
GILLIES Tissue forceps	34
GILLIES Hooks	284
Gouges	116-121
Grasping forceps	52-53
GREENBERG PAR Dissecting scissors	14
GRUENWALD Bayonet forceps	51
GRUENWALD LOVE Rongeurs	187, 263
Guide sleeve	305

H

HAJEK Rongeurs	257
HAJEK-KOFLER Rongeur	257
HALLE Sharp Curettes	126
HALSEY HM Needle holder	67
Handle with quick-lock	160, 169
Hand pieces	313, 315
HAUSER-FRENCH Retractors	210
HAUSER-FRENCH Spreading systems	210
HAVERFIELD SCOVILLE Retractors	213
HAVERFIELD SCOVILLE Spreading systems	213
HEGAR MAYO HM needle holder	68
HEGEMANN-DIETHRICH Vascular scissors	19
HM Ligature scissors	29
Holding arms	175-176
Hollow drill	305
Hook sympathectomy	285
Hooks	162-163, 166, 171, 271-286
Hooks dura	283
Hooks exploration	166, 174, 285
Hooks nerve	171, 272-275
Hooks skin	283
Hooks vessel	275
HUNT Tumor grasping forceps	52

I

INGE Lamina retractors	229
Instrument tray	293
Irrigating instruments	80-83
Irrigation tubes	315

J

JACOBSON HM Micro needle holder	74
JACOBSON Hooks	281
JACOBSON Ligature fork	300
JACOBSON Micro forceps	43
JACOBSON Micro needle holder	74
JACOBSON Micro scissors	24
JACOBSON Vessel knives	298
JACOBSON-ADSON Micro forceps	40
JAMESON REYNOLDS Operating and dissecting scissors	18
JANSEN ZAUFAL Bone rongeurs	133
Jeweler's forceps	39
JULIAN HM Needle holder	70
JULIAN Needle holder	70

K

KERRISON "DieBlauen" Rongeurs	165, 173, 239-242
KERRISON (FERRIS-SMITH) Rongeurs	255

KERRISON (MICRO) Rongeurs	248-254, 256
KERRISON (SCHLESINGER) Rongeurs	247
KERRISON (SPURLING) Rongeurs	243-246
KERRISON Dismantable cervical rongeurs	242
KERRISON Dismantable Rongeurs	165, 173, 239-242
KERRISON Rongeurs	165, 173, 239-242, 258
KEY LISTON Bone cutting forceps	137
KLEINERT-KUTZ Rongeurs	129
KLIMA-ROSEGGER Puncture cannula	81
Knives diamond	292-293
Knot pusher	183
KOCHER MATHIEU HM Needle holder	71
KOFLER HAJEK Rongeurs	257
KOOS Vessel knives	299
KRÄMER Raspatories	101
KRAYENBÜHL Hooks	275
KUTZ KLEINERT Rongeurs	129

L

LAHEY-CLINIC Hooks	284
Lamina retractors	228-229
LANDOLT Scalpel handles	6
LANGENBECK HM Needle holder	72
LEKSELL Rongeurs	135-136
LEMPERT Rongeurs	130
LEMPERT Sharp Curettes	125
LEXER Chisels	114
LEXER Gouges	116-118
LEXER MINI Chisels	114
LEXER MINI Gouges	116
Ligature fork	300
Ligature guides	300
Ligature scissors	29
LISTON-KEY Bone cutting forceps	137
LISTON-LITTAUER Bone cutting forceps	138
LISTON-RUSKIN Bone cutting forceps	138
LITTAUER-LISTON Bone cutting forceps	138
LOVE Nerve root retractors	276-278
LOVE-GRUENWALD Rongeurs	187, 263
LOVE-PAPAVERO Nerve root retractors	163, 278
Lubrication of the motor	320
LUCAE Nerve hooks	272
LUER Rongeurs	130
LUER-STILLE Rongeurs	134

M

MAPN	167-174
Mallets	110-112
MARKHAM-MEYERDING Retractors	230



E02

Alphabetischer Index
Alphabetical Index
Índice alfabético
Index alphabétique
Índice alfabético

ENGLISH

MARQUARDT Bone rongeurs	133
MATHIEU HM Needle holder	71
MATHIEU Needle holder	71
MATHIEU-KOCHER HM Needle holder	71
MAYO HEGAR HM Needle holder	68
MAYO Operating scissors	13
MCINDOE Bone cutting forceps	138
MCINDOE Dressing forceps	34
MEDICON Holding arm	176
Mesh plate cutting scissors	30
METZENBAUM Dissecting scissors	16
METZENBAUM BABY Dissecting scissors	15
METZENBAUM-SLIM Dissecting scissors	17
MEYERDING MARKHAM Retractors	230
MEYERDING Retractors	89
MEYERDING-SCOVILLE Blades	215
MICRO 2000 Forceps	40-42, 48, 54-56
MICRO 2000 Micro needle holders	76, 78
MICRO 2000 Scissors	21, 26
MICRO 2000 Suturing forceps	54-56
MICRO-ADSON Delicate forceps	32
MICRO CASTROVIEJO Micro needle holder	73
Micro curettes	301-302
MICRO-CUSHING Rongeurs	164, 172, 259
Micro-dissectomy	158-166
Micro dissectors	166, 174
Micro forceps	39-50
Micro forceps titanium	44, 46
Micro instruments	295-302
MICRO KERRISON Rongeurs	248-254, 256
Micro ligature adjuster	300
Micro ligature guides	300
Micro needle	301
Micro needle holder titanium	77
Micro needle holders	72-78
Micro raspatories	295-297
Micro rongeurs	164, 172, 259
Micro scissors	20-28, 161, 174
Micro scissors MICRO 2000	21, 26
Micro scissors Vannas	20, 23, 28
Micro scissors, flat handle	22-28
Micro tumor knives	297-298
Micro vessel knives	298-299
MILLESI Micro scissors	24
Miniaturized micro-dissectomy	158-166
MINI RUSKIN Rongeurs	131
MINI-LEXER Chisels	114
MINI-LEXER Gouges	116
MINI-RYDER HM Needle holder	70
MISKIMON Self-retaining retractor	93

Motor tube	319
Motor with INTRA coupling	311
MÜHLING Raspatories	101

N

Needle	301
Needle holders	65-78, 190
Needle holders MICRO 2000	76, 78
Needle holders Micro	72-78
Needle holder titanium	77
NEIVERT HM Needle holder	67
Nerve hooks	171, 272-275
Nerve root retractors	162-163, 171, 276-279
Neuro burrs	317
NICOLA Micro scissors	161, 174
Non-stick forceps	57-61

O

OBWEGESER Soft tissue retractors	91
OLDBERG Rongeurs	264
Operating scissors	10-13

P

PAPAVERO LOVE Nerve root retractors	163, 278
PAPAVERO Suction cannulas	161
PEEK blades	150, 155-156, 197, 200, 205, 221
PEEK spreading system	203-205
PEN Suction cannulas	80
Pestles	113, 179
PETERSEN SMITH Rongeurs	132
Pneumatic high speed motors	307-312
POTTS-SMITH Forceps, dressing/tissue	34
POTTS-SMITH Vascular scissors	19-20
POTTS-YASARGIL Micro scissors	24
Puncture cannula	81

Q

QUINCKE Puncture cannula	81
--------------------------	----

R

Raspatories	100-108, 179, 295-297
RETRACT Spreading system	201-205
Retractor decompression	279
Retractor tissue	228
Retractors	88-91, 92-98, 146-149, 193, 198, 203-204, 206, 208-213, 216-218, 222, 224, 280
Retractors lamina	228-229
Retractors nerve root	162-163, 171, 276-279
Retractors self-retaining	92-98
Retractors soft tissue	91



Retractors spinal	90
REYNOLDS (JAMESON) Dissecting scissors	18
RHOTON Dissectors	288
RHOTON Hooks	282
RHOTON Needles	301
RHOTON Raspatories	296
RHOTON Sharp curettes	301
Rongeurs	163-165, 172-173, 186-189, 237-270
Rongeurs bone	129-137
Rongeurs intervertebral discs	163
Rongeurs micro	164, 172, 259
ROEGGER KLIMA Puncture cannula	81
Rosen burrs	316
RUSKIN Rongeurs	131-132
RUSKIN-LISTON Bone cutting forceps	138
RUSKIN-MINI Rongeurs	131
RYDER MINI HM Needle holder	70
S	
SAMII Tumor knives	298
Scalpel blades	4-6
Scalpel handles	4-6
Scalpels	3-6
SCHLESINGER KERRISON Rongeurs	247
SCHLESINGER Rongeurs	269
Scissors	7-30, 190
Scissors MICRO 2000	21, 26
Scissors delicate	10, 14-15
Scissors dissecting	14-18
Scissors ligature HM	29
Scissors Mesh plate	30
Scissors micro	20-28, 161, 174
Scissors operating	10-13
Scissors round handle Micro	20, 22, 24
Scissors tumor	22
Scissors vascular	19-20
SCOVILLE Blades	215
SCOVILLE-HAVERFIELD Spreading system	213
SCOVILLE MEYERDING Blades	215
SCOVILLE Nerve root retractors	277
SCOVILLE Sharp Curettes	127
SCOVILLE Spreading system	212
SCOVILLE Steel hooks	214
Screwdriver	236
SEDILLOT Raspatories	102
SELECT Delicate forceps	33
SEMB-STILLE Rongeurs	134
SEMKEN Delicate forceps	33
Sharp Curettes	122-127, 301-302
SHEA Dissecting scissors	14
SIDE-LOAD Retractors	224

Skin hooks	283
SLIM Dissecting scissors	15, 17
SLIM METZENBAUM Dissecting scissors	17
SMITH FERRIS KERRISON Rongeurs	255
SMITH FERRIS Rongeurs	186, 261
SMITH POTTS Forceps, dressing/tissue	34
SMITH POTTS Vascular scissors	19-20
SMITH-PETERSEN Rongeurs	132
SMITH FERRIS SPURLING Rongeurs	260
SMITHWICK Sympathectomy hook	285
Soft tissue retractors	91
Spatulas titanium	184
Spatula uvula	286
Specula	155, 183, 226
Spinal retractors	90
Spine thoracoscope	182
Splash guard for dermabrasion	318
Spray adaptor	320
Spreading sleeves	159
Spreading systems	146-156, 193-231
SPREAD-IT Spreading system	191-200
SPURLING FERRIS-SMITH Rongeurs	260
SPURLING KERRISON Rongeurs	243-246
SPURLING Rongeurs	188, 264
Steel blades	206-208, 210-220, 222-223, 227
STEINBACH Mallet	111
STELLBRINK Rongeurs	129
STILLE Bone rongeurs	136
STILLE SEMB Rongeurs	134
STILLE-LUER Rongeurs	134
STRAIGHT Hooks	284
Suction cannulas	80, 82-83, 161, 170, 180
Suction tubes	182
Suturing forceps	54-56
Sympathectomy hook	285
SYPERT Rongeur	268
T	
TAYLOR Blades	214-215
TAYLOR CUSHING HM Bayonet forceps	51
TAYLOR CUSHING Bayonet forceps	51
TAYLOR Spinal retractors	90
THORAMIC	177-190
Thoracoscope	182
Tissue forceps	32-35
Tissue retractor cervical	228
Titanium blades	195-196, 199, 220, 225
Titanium clips	85
Titanium micro forceps	44, 46
Titanium micro needle holders	77



E02

Alphabetischer Index
Alphabetical Index
 Índice alfabético
 Index alphabétique
 Índice alfabético

ENGLISH

Titanium spatulas	184
Titanium spreading systems	193-199
TOENNIS HM Needle holder	72
TOENNIS Tumor grasping forceps	53
Tools tray	320
Tray	320
Trepan motor	312
Trepanation burrs	313
Trocar	306
Trocar holder	169
Trocar sleeves	168
Tubes	319
Tumor grasping forceps	53
Tumor knives	297-298
Tumor scissors	22
TUOHY Puncture cannula	81
Twist drills	236, 318

U

UNIVERSAL HM	
Wire and Mesh plate cutting scissors	30
UNIVERSAL	
Wire and Mesh plate cutting scissors	30
Uvula spatulas	286

V

Vascular forceps atraumatic	36-37
Vascular scissors	19-20
Vertebra burrs	317
Vertebral body dissectors	287
Vertebral distraction devices	235
Vessel hooks	275
Vessel knives	298-299
VIPAIR Pneumatic high speed system	307-320

W

WAGNER Raspatories	108
WAGNER Rongeurs	267-268
Wall tubes	319
WALTER Retractors	280
WEITLANER Self-retaining retractor	92-93
WEITLANER-BECKMANN	
Self-retaining retractor	95
WILDE Rongeurs	270
WILLIAMS Retractors	231
WILLIGER Raspatories	100
Wire and Mesh plate cutting scissors	30
WOOD CRILE HM (DEBAKEY HM)	
Needle holder	69
WOOD CRILE Needle holder	69
WOOD CRILE BABY HM Needle holder	70
WOOD CRILE BABY Needle holder	69

Y

YASARGIL Dissector	287
YASARGIL Ligature guides	300
YASARGIL Micro forceps	47, 49-50
YASARGIL Micro needle holder	74, 78
YASARGIL Micro scissors	24, 26-28
YASARGIL POTTS Micro scissors	24
YASARGIL Raspatories	295-297
YASARGIL Suction tubes	82
YASARGIL Tumor grasping forceps	52-53
YASARGIL Vessel knives	299

Z

ZAUFAL-JANSEN Bone rongeur	133
----------------------------	-----

A	
Adaptador de spray	320
ADSON HM Pinzas finas	32
ADSON Elevador	100
ADSON Ganchitos	283
ADSON JACOBSON Micro pinzas	40
ADSON Legras	102
ADSON MICRO Pinzas finas	32
ADSON Pinzas finas	32
ADSON Separadores autoestáticos	94, 96
ADSON-ANDERSON Separadores autoestáticos	94
ADSON BECKMANN Separadores autoestáticos	97
Aguja	301
ANDERSON ADSON Separadores autoestáticos	94
AUSTIN Pinzas para sutura	56
B	
BABY-CRILE-WOOD HM Porta-agujas	70
BABY-CRILE-WOOD Porta-agujas	69
BABY-METZENBAUM Tijeras para preparaciones	15
BACON Pinza gubia	130
Bandeja de limpieza	320
BARRAQUER Micro porta-agujas	73
BAUMGARTNER HM Porta-agujas	67
BECKMANN Separadores autoestáticos	96
BECKMANN-ADSON Separadores autoestáticos	97
BECKMANN-EATON Separadores autoestáticos	98
BECKMANN WEITLANER Separadores autoestáticos	95
BEYER Pinzas gubias	129, 133
BIEMER Micro tijera	23
BIER Cánulas para la punción	81
BINNER Bipolator	183
Bipolator	170
Bisturís	3-6
BÖHM Extracción esponjosa	303-306
Brazos de soporte	175-176
Brocas espirales	236, 318
Brocas para cemento	317
Brocas Rosen	316
BRUNS Cucharillas cortantes	122-124
C	
Cabezales de trabajo	313, 315
Cables de conexión bipolar	64
Caja para instrumentos	293

Caja para terminales	320
Calibre de profundidad	194, 199, 225
Cánula de aspiración en forma bayoneta	83
Cánulas de aspiración	80, 82-83, 161, 170, 182
Cánulas de aspiración con dispositivo en forma de "gota"	83
Cánulas para la punción	81
CASPAR Contra-separadores	226
CASPAR Disectores	287, 289-290
CASPAR Espéculos	181, 226
CASPAR Ganchitos para exploración	166, 174, 285
CASPAR Ganchos	206
CASPAR Ganchos	214
CASPAR Legras	101
CASPAR Micro disectores	166
CASPAR Pinzas cortantes	189, 265-267
CASPAR Pinzas cortantes para discos intervertebrales	163
CASPAR Pisón	113
CASPAR Separadores	206, 216-218
CASPAR Separadores para raíz nerviosa	162, 279
CASPAR Sistemas des separadores	206, 216-218, 226
CASPAR Sistemas des separadores	212
CASPAR Valvas	207
Casquillo de guía	305
Casquillos portabrocas	235
CASTROVIEJO HM Micro porta-agujas	72-73
CASTROVIEJO Porta-agujas	72
CASTROVIEJO-MICRO Porta-agujas	73
CERVICALINO Sistema de separador	143-150
Cinceles	114-115, 180
CITELLI Pinzas saca-bocadas	258
CLINIC LAHEY Ganchitos	284
CLOWARD Pinzas cortantes	269
CLOWARD Separadores	222
CLOWARD Separadores laminar	228
CLOWARD Sistemas des separadores	222
CLOWARD Valvas	223
COBB Gubias	119
COBB Legras	107
Contenedor doble	320
CONTOUR Separadores autoestáticos	94
Contra-separadores	154, 226
COTTLE Martillo	110
Cranéotomos	313
CRILE Ganchitos	283
CRILE-WOOD HM (DEBAKEY HM) Porta-agujas	69
CRILE-WOOD Porta-agujas	69
CRILE-WOOD BABY HM Porta-agujas	70



CRILE-WOOD BABY Porta-agujas	69
Cucharillas (dentada)	181
Cucharillas cortantes	122-127, 301-302
Cuchillos de diamante	292-293
Cuchillos para tumores	297-298
Cuchillos para vasos	298-299
Curetas	302
CUSHING (TAYLOR) HM Pinza en forma bajoneta	51
CUSHING (TAYLOR) Pinza en forma bajoneta	51
CUSHING HM Pinzas anatómicas	35
CUSHING Ganchitos para nervios	273
CUSHING Legras	103
CUSHING MICRO Pinzas cortantes	164, 172, 259
CUSHING Pinzas anatómicas/quirúrgicas	35
CUSHING Pinzas cortantes	172, 259, 262
CUSHING Separador para decompresión	279
D	
DAHMEN Cinceles	115
DAHMEN Gubias	120-121
DANDY Separadores para raíz nerviosa	276
DAUBENSPECK Cucharillas cortantes	126
DEBAKEY AT Pinzas atraumáticas	36-39
DEBAKEY HM CRILE-WOOD HM Porta-agujas	69
DENNIS Micro pinzas	45
Destornillador	236
DIETHRICH HEGEMANN Tijeras vasculares	19
Disectores	185, 287-290
Disectores cuerpo vertebrales	287
Dispositivo	64
Distractores vertebrales	235
E	
EATON-BECKMANN Separadores autoestáticos	98
ECHLIN Pinzas gubias	137
EIF Ganchitos	275
Electrodo	185
Elevadores	100
Espátulas de titanio	184
Espátulas para uvula	286
Espéculos	155, 183, 226
Extracción esponjosa	303-306
F	
FERGUSSON FRAZIER Cánulas de aspiración	82, 170
FERRIS-SMITH Pinzas saca-bocadas	261
FERRIS-SMITH-SPURLING Pinzas saca-bocadas	260

FERRIS-SMITH KERRISON Pinzas saca-bocadas	255
FERRIS-SMITH Pinzas saca-bocadas	186
FISCH Ganchitos	281
FRAZIER (FERGUSSON) Cánulas de aspiración	82, 170
FRAZIER Cánulas de aspiración	81-82
FRAZIER Ganchitos	284
FREER Elevadores	100
FREER Legras	100
FRENCH HAUSER Separadores	210
FRENCH HAUSER Sistemas des separadores	210
Fresas	313, 316-318
Fresas "Flameshape"	317
Fresas cilíndricas	317
Fresas cilíndricas de diamante	316
Fresas de trépano	313
Fresas neuro	317
Fresas para craneotomo	313
Fresas para la dermoabrasión	318
Fresas para vértebras	317
Fresas redondas de diamante	316
FRIEDMANN Pinza gubia	129
G	
Ganchitos	162-163, 166, 171, 271-286
Ganchitos para duramadre	283
Ganchitos para exploración	166, 174, 285
Ganchitos para nervios	171, 272-275
Ganchitos para piel	283
Ganchitos para vasos	275
Gancho simpatectomia	285
GILLIES Ganchitos	284
GILLIES Pinza quirúrgica	34
GREENBERG PAR Tijeras para preparaciones	14
GRUENWALD LOVE Pinzas cortantes	187, 263
GRUENWALD Pinzas en forma bajoneta	51
Gubias	116-121
Guía de nudos	183
Guías-hilos	300
H	
HAJEK Pinzas saca-bocadas	257
HAJEK-KOFLER Pinza saca-bocada	257
HALLE Cucharillas cortantes	126
HALSEY HM Porta-agujas	67
HAUSER-FRENCH Separadores	210
HAUSER-FRENCH Sistemas des separadores	210
HAVERFIELD SCOVILLE Separadores	213
HAVERFIELD SCOVILLE Sistemas des separadores	213
HEGAR MAYO HM Porta-agujas	68

HEGEMANN-DIETRICH Tijeras vasculares	19
HM Tijeras para ligaduras	29
Hojas de bisturí	4-6
Horquilla de hilos	300
HUNT Pinza para agarrar	52

I	
INGE Separadores laminar	229
Instrumentos de aspiración y de lavado	79-83, 161, 170, 180
Interruptor a pedal	319

J	
JACOBSON HM Micro porta-agujas	74
JACOBSON Cuchillos para vasos	298
JACOBSON Ganchitos	281
JACOBSON Horquilla de hilos	300
JACOBSON Micro pinzas	43
JACOBSON Micro porta-agujas	74
JACOBSON Micro tijeras	24
JACOBSON-ADSON Micro pinzas	40
JAMESON REYNOLDS Tijeras para preparaciones	18
JANSEN ZAUFAL Pinza gubia	133
Juegos de dilatadores	160, 170
JULIAN HM Porta-agujas	70
JULIAN Porta-agujas	70

K	
KERRISON "DieBlauen" Pinzas saca-bocadas	165, 173, 239-242
KERRISON (FERRIS-SMITH) Pinzas saca-bocadas	255
KERRISON (MICRO) Pinzas saca-bocadas	248-254, 256
KERRISON (SCHLESINGER) Pinzas saca-bocadas	247
KERRISON (SPURLING) Pinzas saca-bocadas	243-246
KERRISON Pinza saca-bocada desmontable	165, 173, 239-242
KERRISON Pinza saca-bocada desmontable cervical	242
KERRISON Pinzas saca-bocadas	165, 173, 239-242, 258
KEY LISTON Pinza cortante para huesos	137
KLEINERT-KUTZ Pinzas gubias	129
KLIMA-ROSEGGER Cánulas para la punción	81
KOCHER MATHIEU HM Porta-agujas	71
KOFLER HAJEK Pinza saca-bocada	257
KOOS Cuchillos para vasos	299
KRÄMER Legras	101

KRAYENBÜHL Ganchitos	275
KUTZ KLEINERT Pinzas gubias	129

L	
LAHEY-CLINIC Ganchitos	284
LANDOLT Mangos de bisturí	6
LANGENBECK HM Porta-agujas	72
Legras	100-108, 179, 295-297
LEKSELL Pinzas gubias	135-136
LEMPERT Cucharillas cortantes	125
LEMPERT Pinzas gubias	130
LEXER Cinceles	114
LEXER Gubias	116-118
LEXER MINI Cinceles	114
LEXER MINI Gubias	116
LISTON-KEY Pinzas cortantes para huesos	137
LISTON LITTAUER Pinza cortante para huesos	138
LISTON RUSKIN Pinzas cortante para huesos	138
LITTAUER-LISTON Pinza cortante para huesos	138
LOVE Separadores para raíz nerviosa	276-278
LOVE-GRUENWALD Pinzas cortantes	187, 263
LOVE-PAPAVERO Separadores para raíz nerviosa	163, 278
Lubrificante para el motor	320
LUCAE Ganchitos para nervios	272
LUER Pinzas gubias	130
LUER STILLE Pinzas gubias	134

M	
Mango con cierre rápido	160, 169
Mangos de bisturí	4-6
MAPN	167-174
MARKHAM-MEYERDING Separadores	230
MARQUARDT Pinzas gubias	133
Martillos	110-112
MATHIEU HM Porta-agujas	71
MATHIEU Porta-agujas	71
MATHIEU-KOCHER HM Porta-agujas	71
MAYO-HEGAR HM Porta-agujas	68
MAYO Tijeras quirúrgicas	13
MCINDOE Pinzas cortantes para huesos	138
MCINDOE Pinzas anatómicas	34
MEDICON Brazo de soporte	176
METZENBAUM Tijeras para preparaciones	16
METZENBAUM BABY Tijeras para preparaciones	15
METZENBAUM-SLIM Tijeras para preparaciones	17
MEYERDING MARKHAM Separadores	230
MEYERDING Separadores	89
MEYERDING-SCOVILLE Valvas	215
MICRO 2000 Micro porta-agujas	76, 78



MICRO 2000 Micro tijeras	21, 26
MICRO 2000 Pinzas	40-42, 48, 54-56
MICRO 2000 Pinzas para sutura	54-56
MICRO-ADSON Pinzas finas	32
MICRO CASTROVIEJO Micro porta-agujas	73
Micro curetas	302
Microdissectomía	158-166
MICRODISC-XS	157-166
Micro disectores	166, 174
Micro instrumentos	295-302
MICRO KERRISON	
Pinzas saca-bocadas	248-254, 256
Micro pinzas	39-50
Micro pinzas cortantes	164, 172, 259
Micro porta-agujas	72-78
Micro porta-agujas Titanio	77
Micro tijeras	20-28, 161, 174
Micro tijeras MICRO 2000	21, 26
Micro tijeras con mangos llanos	22-28
Micro tijeras con mangos redondos	20, 22, 24
Micro tijeras Vannas	20, 23, 28
MICRO-CUSHING	
Pinzas cortantes	164, 172, 259
MILLES Micro tijeras	24
MINI RUSKIN Pinzas gubias	131
MINI-LEXER Cinceles	114
MINI-LEXER Gubias	116
MINI-RYDER HM Porta-agujas	70
MISKIMON Separadores autoestáticos	93
Motor angulado	314
Motor con acoplamiento INTRA	311
Motor de trépano	312
Motores neumáticos	307-312
MÜHLING Legras	101
N	
NEIVERT HM Porta-agujas	67
NICOLA Micro tijera	161, 174
O	
OBWEGESER	
Separadores para partes blandas	91
OLDBERG Pinzas cortantes	264
P	
PAPAVERO Cánulas de aspiración	161
PAPAVERO LOVE	
Separadores para raíz nerviosa	163, 278
PEEK Sistema separador	203-205
PEN Cánulas de aspiración	79-80
PETERSEN SMITH Pinzas gubias	132
PICCOLINO Sistema de separador	151-156

Pinza	
para cambiar las valvas	197, 200, 207, 221
Pinza para cortar esponjosa	306
Pinza saca-bocada	
desmontable	165, 173, 239-242
Pinzas	31-63, 197
Pinzas HM	32, 35, 51
Pinzas MICRO 2000	40-42, 48, 54-56
Pinzas anatómicas	32-35
Pinzas atraumáticas	36-39
Pinzas bipolares	58-63
Pinzas bipolares no adherentes	57-61
Pinzas cortantes	163-164, 172, 187-189, 259-270
Pinzas cortantes para discos intervertebrales	163
Pinzas cortantes para huesos	137-138
Pinzas en forma bajoneta	47-53, 60-63
Pinzas gubias	129-137
Pinzas para agarrar	52-53, 187
Pinzas para agarrar tumores	53
Pinzas para aplicar	86
Pinzas para joyero/relojero	39, 58-59
Pinzas para sutura	54-56
Pinzas saca-bocadas	165, 173, 186, 237-258
Pinzas vasculares atraumáticas	36-37
Pistón	113, 179
Porta-agujas	65-78, 190
Porta-agujas MICRO 2000	76, 78
Porta-agujas micro	72-78
POTTS-SMITH	
Pinzas anatómicas/quirúrgicas	34
POTTS-SMITH Tijeras vasculares	19-20
POTTS-YASARGIL Micro tijeras	24
Protección contra riego para la dermabrasion	318
Q	
QUINCKE Cánulas para la punción	81
R	
RETRACT Sistema de separador	201-205
REYNOLDS (JAMESON)	
Tijeras para preparaciones	18
RHOTON Aguja	301
RHOTON Cucharillas cortantes	301
RHOTON Disectores	288
RHOTON Ganchitos	282
RHOTON Legras	296
ROSEGGGER KLIMA	
Cánulas para la punción	81
RUSKIN Pinzas gubias	131-132
RUSKIN-LISTON	
Pinzas cortantes para huesos	138



RUSKIN-MINI Pinzas gubias	131
RYDER MINI HM Porta-agujas	70
S	
SAMII Cuchillos para tumores	298
SCHLESINGER KERRISON Pinzas saca-bocadas	247
SCHLESINGER Pinzas cortantes	269
SCHMIEDEN (TAYLOR) Tijeras para duramadre	29
SCOVILLE Cucharillas cortantes	127
SCOVILLE Ganchos de acero	214
SCOVILLE-HAVERFIELD Sistema de separador	213
SCOVILLE MEYERDING Valvas	215
SCOVILLE Separadores para raíz nerviosa	277
SCOVILLE Sistema de separador	212
SCOVILLE Valves de acero	215
SEDILLOT Legras	102
SELECT Pinzas finas	33
SEMB-STILLE Pinzas gubias	134
SEMKEN Pinzas finas	33
Separador para decompresión	279
Separador para tejido cervical	228
Separadores	88-91, 146-149, 193, 198, 203-204, 206, 208-213, 216-218, 222, 224, 280
Separadores autoestáticos	92-98
Separadores espinales	90
Separadores laminar	228-229
Separadores para partes blandas	91
Separadores para raíz nerviosa	162-163, 171, 276-279
SHEA Tijeras para preparaciones	14
SIDE-LOAD Separadores	224
Sistemas de distractor	233, 234
Sistemas des separadores	146-156, 193-231
SLIM METZENBAUM Tijeras para preparaciones	17
SLIM Tijeras para preparaciones	15, 17
SMITH FERRIS KERRISON Pinzas saca-bocadas	255
SMITH FERRIS Pinzas saca-bocadas	184
SMITH FERRIS Pinzas cortanteas	261
SMITH POTTS Pinzas anatómicas/quirúrgicas	34
SMITH POTTS Tijeras vasculares	19-20
SMITH-PETERSEN Pinzas gubias	132
SMITH FERRIS SPURLING Pinzas saca-bocadas	260
SMITHWICK Gancho simpatectomia	285

Soportes de valvas	194
Soportes para trocar	169
SPURLING FERRIS-SMITH Pinzas cortantes	260
SPREAD-IT Sistema de separador	191-200
SPURLING KERRISON Pinzas saca-bocadas	243-246
SPURLING Pinzas cortantes	188
SPURLING Pinzas saca-bocadas	264
STEINBACH Martillo	111
STELLBRINK Pinzas gubias	129
STILLE Pinza gubia	136
STILLE SEMB Pinzas gubias	134
STILLE-LUER Pinzas gubias	134
STRAIGHT Ganchitos	284
STRULLY Tijeras para trigémino	29
SYPERT Pinza cortante	268
T	
Taladro acanalado	305
TAYLOR CUSHING HM Pinza en forma bajoneta	51
TAYLOR CUSHING Pinzas en forma bajoneta	51
TAYLOR SCHMIEDEN Tijeras para duramadre	29
TAYLOR Separadores espinales	90
TAYLOR Valvas	214-215
THORAMIC	177-190
Tijeras	7-30, 190
Tijeras de preparaciones	14-18
Tijeras finas	10, 14-15
Tijeras micro	20-28, 161,174
Tijeras MICRO 2000	21, 26
Tijeras para cortar alambre y placas Mesh	30
Tijeras para ligaduras HM	29
Tijeras para tumores	22
Tijeras quirúrgicas	10-13
Tijeras vasculares	19-20
Titanio Clips	85
TITANIO Micro porta-agujas	77
TOENNIS HM Porta-agujas	72
TOENNIS Pinzas para agarrar tumores	53
Toracoscopio	180
Toracoscopio para la columna vertebral	182
Tornillos de distracción	236
Trocar	306
Tubo de motor	319
Tubos aspirador	180
Tubos de irrigación	315
Tubos murales	319
TUOHY Cánulas para la punción	81



U	
UNIVERSAL HM	
Tijeras para cortar alambre y placas Mesh	30
UNIVERSAL	
Tijeras para cortar alambre y placas Mesh	30
V	
Vainas de trocar	168
Vainas desplegadas	159
Valvas de acero	206-208, 210-220, 222-223, 227
Valvas de aluminio	209
Valvas de PEEK	150, 155-156, 197, 200, 205, 221
Valvas de titanio	195-196, 199, 220, 225
VIPAIR Sistema de motor neumático	307-320
W	
WAGNER Legras	108
WAGNER Pinzas cortantes	267-268
WALTER Separadores	280
WEITLANER Separadores autoestáticos	92-93
WEITLANER-BECKMANN	
Separadores autoestáticos	95
WILDE Pinzas cortantes	270
WILLIAMS Separadores	231
WILLIGER Legras	100
WOOD CRILE HM (DEBAKEY HM)	
Porta-agujas	69
WOOD CRILE Porta-agujas	69
WOOD CRILE BABY HM Porta-agujas	70
WOOD CRILE BABY Porta-agujas	69
Y	
YASARGIL Cuchillos para vasos	299
YASARGIL Disector	287
YASARGIL Guías-hilos	300
YASARGIL Legras	295-297
YASARGIL Micro pinzas	47, 49-50
YASARGIL Micro porta-agujas	74, 78
YASARGIL Micro tijeras	24, 26-28
YASARGIL Pinzas para agarrar tumores	52-53
YASARGIL POTTS Micro tijera	24
YASARGIL Tubos aspirador	82
Z	
ZAUFAL-JANSEN Pinza gubia	133

A	
Adaptateur du spray	320
ADSON HM Pincés fines	32
ADSON Crochets	283
ADSON Ecarteurs autostatiques	94, 96
ADSON Elévateurs	100
ADSON JACOBSON Micro-pincés	40
ADSON MICRO Pincés fines	32
ADSON Pincés fines	32
ADSON Rugines	102
ADSON-ANDERSON Ecarteurs autostatiques	94
ADSON-BECKMANN Ecarteurs autostatiques	97
Aiguille	301
ANDERSON-ADSON Ecarteurs autostatiques	94
AUSTIN Pincés à sutures	56
B	
BABY-CRILE-WOOD HM Porte-aiguilles	70
BABY-CRILE-WOOD Porte-aiguille	69
BABY-METZENBAUM Ciseaux à préparations	15
BACON Pince-gouge	130
BARRAQUER Micro porte-aiguilles	73
BAUMGARTNER HM Porte-aiguille	67
BECKMANN Ecarteurs autostatiques	96
BECKMANN-ADSON Ecarteurs autostatiques	97
BECKMANN-EATON Ecarteurs autostatiques	98
BECKMANN WEITLANER Ecarteurs autostatiques	95
BEYER Pince-gouge	129, 133
BIEMER Micro ciseaux	23
BIER Canules pour la ponction	81
BINNER Bipolateur	183
Bipolateur	170
Bistouris	3-6
BÖHM Extraction spongieuse	303-306
Bras des support	175-176
BRUNS Curettes tranchantes	122-124
C	
Câbles connecteurs bipolaires	64
Canules à aspiration	80, 82-83, 161, 170, 182
Canules à aspiration avec dispositif en forme de "goutte"	83
Canules à aspiration en forme baïonnette	83
Canules à ponctions	81
CASPAR Contre-écarteurs	226
CASPAR Crochets	206
CASPAR Crochets	214
CASPAR Crochets pour exploration	166, 174, 285
CASPAR Dissecteurs	287, 289-290
CASPAR Ecarteurs	206, 216-218

CASPAR Ecarteurs à racines nerveuses	162, 279
CASPAR Micro dissecteurs	166
CASPAR Pilon	113
CASPAR Rongeurs	189, 265-267
CASPAR Rongeurs pour disques intervertébraux	163
CASPAR Rugines	101
CASPAR Spéculums	181, 226
CASPAR Systèmes d'écarteurs	206, 216-218, 226
CASPAR Valves	207
Cassette pour instruments	293
Cassette pour outils	320
CASTROVIEJO HM Micro porte-aiguilles	72-73
CASTROVIEJO Porte-aiguilles	72
CASTROVIEJO-MICRO Porte-aiguilles	73
Ciseaux	7-30, 190
Ciseaux à ligature HM	29
Ciseaux à préparations	14-18
Ciseaux burins	114-115, 180
Ciseaux chirurgicaux	10-13
Ciseaux coupe-fil et coupe-plaques Mesh	30
Ciseaux délicats	10, 14-15
Ciseaux micro	20-28, 161, 174
Ciseaux MICRO 2000	21, 26
Ciseaux pour tumeur	22
Ciseaux vasculaires	19-20
CITELLI Pincés emporte-pièce	258
CLINIC LAHEY Crochets	284
Clips en titane	85
CLOWARD Ecarteurs	222
CLOWARD Ecarteurs lamina	228
CLOWARD Rongeurs	269
CLOWARD Systèmes d'écarteurs	222
CLOWARD Valves	223
COBB Gouges	119
COBB Rugines	107
Container double	320
CONTOUR Ecarteurs autostatiques	94
Contre-écarteurs	154, 226
COTTLE Maillet	110
Couteaux à tumeurs	297-298
Couteaux de diamant	292-293
Couteaux pour vaisseaux	298-299
Crâniotomes	313
CRILE Crochets	283
CRILE-WOOD HM (DEBAKEY HM) Porte-aiguilles	69
CRILE-WOOD Porte-aiguilles	69
CRILE-WOOD BABY HM Porte-aiguilles	70
CRILE-WOOD-BABY Porte-aiguilles	69
Crochet sympathectome	285



Crochets	162-163, 166, 171, 271-286
Crochets à nerfs	171, 272-275
Crochets pour exploration	166, 174, 285
Crochets pour dure-mère	283
Crochets pour peau	283
Crochets à vaisseaux	275
Curettes	302
Curettes (dentelée)	181
Curettes tranchantes	122-127, 301-302
CUSHING (TAYLOR) HM Pince en forme baïonnette	51
CUSHING (TAYLOR) Pincettes en forme baïonnette	51
CUSHING HM Pincettes anatomiques	35
CUSHING Crochets à nerfs	273
CUSHING Ecarteur décompresseur	279
CUSHING MICRO Rongeurs	164, 172, 259
CUSHING Pincettes anatomiques/chirurgicales	35
CUSHING Rongeurs	172, 259, 262
CUSHING Rugines	103

D

DAHMEN Ciseaux burins	115
DAHMEN Gouges	120-121
DANDY Ecarteurs à racines nerveuses	276
DAUBENSPECK Curettes tranchantes	126
DEBAKEY AT Pincettes vasculaires atraumatiques	36-39
DEBAKEY CRILE-WOOD HM Porte-aiguille	69
DENNIS Micro pincettes	45
DIETRICH HEGEMANN Ciseaux vasculaires	19
Dispositif	64
Dissecteurs	185, 287-290
Dissecteurs corps vertébrales	287
Distracteurs vertébraux	235
Douilles de forage	235
Douille guidage	305

E

EATON BECKMANN Ecarteurs autostatiques	98
Ecarteur de tissu cervical	228
Ecarteur décompresseur	279
Ecarteurs	88-91, 146-149, 193, 198, 203-204, 206, 208-213, 216-218, 222, 224, 280
Ecarteurs à racines nerveuses	162-163, 171, 276-279
Ecarteurs autostatiques	92-98
Ecarteurs lamina	228-229
Ecarteurs pour parties molles	91
Ecarteurs spinaux	90

ECHLIN Pincettes-gouges	137
EIF Crochets	275
Electrode	185
Elévateurs	99-100
Extraction spongieuse	303-306

F

FERGUSON FRAZIER Canules à aspiration	82, 170
FERRIS-SMITH Rongeurs	261
FERRIS-SMITH-SPURLING Rongeurs	260
FERRIS-SMITH KERRISON Pincettes emporte-pièce	255
FERRIS-SMITH Pincettes emporte-pièce	186
FISCH Crochets	281
Forêt creux	305
Forêt hélicoïdale	236
Fourreaux de trocart	168
Fraises	313, 316-318
Fraises "Flameshape"	317
Fraises à ciment	317
Fraises à dermabrasion	318
Fraises à trépan	313
Fraises cylindriques	317
Fraises cylindriques diamantées	316
Fraises de Rosen	316
Fraises en spirale	318
Fraises forme boule diamantées	316
Fraises neuro	317
Fraises pour crâniotome	313
Fraises vertébrales	317
FRAZIER (FERGUSON) Canules à aspiration	82, 170
FRAZIER Canules à aspiration	81-82
FRAZIER Crochets	284
FREER Elévateurs	100
FREER Rugines	100
FRENCH HAUSER Ecarteurs	210
FRENCH HAUSER Systèmes d'écarteurs	210
FRIEDMANN Pince-gouge	129

G

GILLIES Crochets	284
GILLIES Pince chirurgicale	34
Gouges	116-121
GREENBERG PAR Ciseaux à préparations	14
GRUENWALD LOVE Rongeurs	187, 263
GRUENWALD Pincettes forme baïonnette	51
Guide de profondeur	194, 199, 225
Guides-fils	300

H

HAJEK Pincettes emporte-pièce	257
HAJEK-KOFLER Pince emporte-pièce	257

HALLE Curettes tranchantes	126
HALSEY HM Porte-aiguille	67
HAUSER-FRENCH Systèmes d'écarteurs	210
HAVERFIELD SCOVILLE Systèmes d'écarteurs	213
HEGAR MAYO HM Porte-aiguilles	68
HEGEMANN-DIETHRICH Ciseaux vasculaires	19
HM Ciseaux à ligature	29
HUNT Pince pour saisir	52

I	
INGE Ecarteurs lamina	229
Instruments à aspiration et à irrigation	79-83, 161, 170, 180
Interrupteur à pédale	319

J	
JACOBSON HM Micro porte-aiguilles	74
JACOBSON Couteaux pour vaisseaux	298
JACOBSON Crochets	281
JACOBSON Micro ciseaux	24
JACOBSON Micro pinces	43
JACOBSON Micro porte-aiguilles	74
JACOBSON Pousse-fil	300
JACOBSON-ADSON Micro pinces	40
JAMESON REYNOLDS Ciseaux à préparations	18
JANSEN ZAUFAL Pince-gouge	133
Jeux de dilateurs	160, 170
JULIAN HM Porte-aiguilles	70
JULIAN Porte-aiguilles	70

K	
KERRISON "DieBlauen" Pincés emporte-pièce	165, 173, 239-242
KERRISON (FERRIS-SMITH) Pincés emporte-pièce	255
KERRISON (MICRO) Pincés emporte-pièce	248-254, 256
KERRISON (SCHLESINGER) Pincés emporte-pièce	247
KERRISON (SPURLING) Pincés emporte-pièce	243-246
KERRISON Pincés emporte-pièce	165, 173, 239-242, 258
KERRISON Pincés emporte-pièce desmontables	165, 173, 239-242
KERRISON Pincés emporte-pièce desmontables cervicale	242
KEY LISTON Pince à os	137
KLEINERT-KUTZ Pincés-gouges	129
KLIMA-ROSEGGER Canule pour la ponction	81
KOCHER MATHIEU HM Porte-aiguilles	71

KOFLER HAJEK Pince emporte-pièce	257
KOOS Couteaux pour vaisseaux	299
KRÄMER Rugines	101
KRAYENBÜHL Crochets	275
KUTZ KLEINERT Pincés-gouges	129

L	
LAHEY-CLINIC Crochets	284
Lames de bistouri	4-6
LANDOLT Manches pour bistouri	6
LANGENBECK HM Porte-aiguilles	72
LEKSELL Pincés-gouges	135-136
LEMPERT Curettes tranchantes	125
LEMPERT Pincés-gouges	130
LEXER Ciseaux burins	114
LEXER Gouges	116-118
LEXER MINI Ciseaux burins	114
LEXER MINI Gouges	116
LISTON-KEY Pince à os	137
LISTON LITTAUER Pince à os	138
LISTON RUSKIN Pincés à os	138
LITTAUER-LISTON Pince à os	138
LOVE Ecarteurs à racines nerveuses	276-278
LOVE-GRUENWALD Rongeurs	187, 263
LOVE-PAPAVERO Ecarteurs à racines nerveuses	163, 278
Lubrifiant pour le moteur	320
LUCAE Crochets à nerfs	272
LUER Pincés-gouges	130
LUER STILLE Pincés-gouges	134

M	
Maillets	110-112
Manches pour bistouris	3-6
MAPN	167-174
MARKHAM-MEYERDING Ecarteurs	230
MARQUARDT Pince-gouge	133
MATHIEU HM Porte-aiguilles	71
MATHIEU Porte-aiguilles	71
MATHIEU-KOCHER HM Porte-aiguilles	71
MAYO Ciseaux chirurgicaux	13
MAYO HEGAR HM Porte-aiguilles	68
MCINDOE Pincés à os	138
MCINDOE Pince anatomique	34
MEDICON Bras de support	176
METZENBAUM Ciseaux à préparations	16
METZENBAUM BABY Ciseaux à préparations	15
METZENBAUM-SLIM Ciseaux à préparations	17
MEYERDING Ecarteurs	89
MEYERDING MARKHAM Ecarteurs	230
MEYERDING-SCOVILLE Valves	215
MICRO 2000 Ciseaux	21, 26



E04

Alphabetischer Index
Alphabetical Index
Índice alfabético
Index alphabétique
Índice alfabético

MICRO 2000 Micro porte-aiguilles	76, 78
MICRO 2000 Pincés	40-42, 48, 54-56
MICRO 2000 Pincés à suture	54-56
MICRO ADSON Pincés fines	32
MICRO CASTROVIEJO Micro porte-aiguilles	73
Micro ciseaux	20-28, 161, 174
Micro ciseaux MICRO 2000	21, 26
Micro ciseaux à manche plat	22-28
Micro ciseaux à manche rond	20, 22, 24
Micro ciseaux Vannas	20, 23, 28
Micro curettes	302
Microdissectomie	158-166
MICRODISC-XS	157-166
Micro dissecteurs	166, 174
Micro instruments	295-302
MICRO-CUSHING Rongeurs	164, 172, 259
MICRO KERRISON	
Pincés emporte-pièce	248-254, 256
Micro pincés	39-50
Micro porte-aiguilles	72-78
Micro porte-aiguilles en titane	77
Micro rongeurs	164, 172, 259
MILLESÍ Micro ciseaux	24
MINI RUSKIN Pincés-gouges	131
MINI-LEXER Ciseaux burins	114
MINI-LEXER Gouges	116
MINI-RYDER HM Porte-aiguilles	70
MISKIMON Ecarteurs autostatiques	93
Moteur à trépan	312
Moteur angulaire	314
Moteur avec embrayage INTRA	311
Moteurs pneumatiques	307-312
MÜHLING Rugines	101
N	
NEIVERT HM Porte-aiguille	67
NICOLA Micro ciseaux	161, 174
O	
OBWEGESER Ecarteurs pour parties molles	91
OLDBERG Rongeurs	264
P	
PAPAVERO Canules à aspiration	161
PAPAVERO LOVE	
Ecarteurs à racines nerveuses	163, 278
PEEK Système d'écarteur	151-156
PEN Canules à aspiration	79-80
PETERSEN SMITH Pincés-gouges	132
PICCOLINO Système d'écarteur	151-156
Pièces à main	313, 315
Pilon	113, 179

Pince à couper les spongieuse	306
Pince à préhension	53
Pince pour joaillier/horloger	39, 58-59
Pince pour le changement des valves	197, 200, 207, 221
Pincés	31-63, 197
Pincés HM	32, 35, 51
Pincés MICRO 2000	40-42, 48, 54-56
Pincés à os	137-138
Pincés à poser	86
Pincés à sutures	54-56
Pincés anatomiques	32-35
Pincés atraumatiques	36-39
Pincés bipolaires	58-63
Pincés bipolaires anti-adhésives	57-61
Pincés emporte-pièce	165, 173, 186, 237-258
Pincés emporte-pièce desmontables	165, 173, 239-242
Pincés en forme baïonnette	47-53, 60-63
Pincés pour saisir	52-53
Pincés pour préhension de tumeurs	53
Pincés vasculaires atraumatiques	36-37
Pincés-gouges	129-137
Porte-aiguilles	65-78, 190
Porte-aiguilles MICRO 2000	76, 78
Porte-aiguilles micro	72-78
POTTS-SMITH Ciseaux vasculaires	19-20
POTTS-SMITH	
Pincés anatomiques/chirurgicales	34
POTTS-YASARGIL Micro ciseaux	24
Pousse-fil	300
Pousse-noeuds	183
Protection anti-projections à dermabrasion	318
Q	
QUINCKE Canules pour la ponction	81
R	
RETRACT Système d'écarteur	201-205
REYNOLDS (JAMESON)	
Ciseaux à préparations	18
RHOTON Aiguille	301
RHOTON Crochets	282
RHOTON Curettes tranchantes	301
RHOTON Dissecteurs	288
RHOTON Rugines	296
Rongeurs	163-164, 172, 187-189, 259-270
Rongeurs pour disques intervertébraux	163
ROSEGGER KLIMA Canule pour la ponction	81
Rugines	100-108, 179, 295-297
RUSKIN Pincés-gouges	131-132

RUSKIN-LISTON Pincés à os	138
RUSKIN-MINI Pincés-gouges	131
RYDER MINI HM Porte-aiguilles	70

S

SAMII Couteaux à tumeurs	298
SCHLESINGER KERRISON Pincés emporte-pièce	247
SCHLESINGER Rongeurs	269
SCHMIEDEN (TAYLOR) Ciseaux pour dure-mère	29
SCOVILLE Curettes tranchantes	127
SCOVILLE Crochets en acier	214
SCOVILLE Ecarteurs à racines nerveuses	277
SCOVILLE-HAVERFIELD Système d'écarteur	213
SCOVILLE MEYERDING Valves	215
SCOVILLE Système d'écarteur	212
SCOVILLE Valves en acier	215
SEDILLOT Rugines	102
SELECT Pincés fines	33
SEMB-STILLE Pincés-gouges	134
SEMKEN Pincés fines	33
SHEA Ciseaux à préparations	14
SIDE-LOAD Ecarteurs	224
SLIM Ciseaux à préparations	15, 17
SLIM METZENBAUM Ciseaux à préparations	17
SMITH FERRIS KERRISON Pincés emporte-pièce	255
SMITH FERRIS Pincés emporte-pièce	186
SMITH FERRIS Rongeurs	261
SMITH POTTS Ciseaux vasculaires	19-20
SMITH POTTS Pincés anatomiques/chirurgicales	34
SMITH-PETERSEN Pincés-gouges	132
SMITH FERRIS SPURLING Rongeurs	260
SMITHWICK Crochet sympathectome	285
Spatules en titane	184
Spatules uvulaire	286
Spéculum	155, 183, 226
Spéculum écarteur	159
SPREAD-IT Systèmes d'écarteurs	191-200
SPURLING FERRIS-SMITH Rongeurs	260
SPURLING KERRISON Pincés emporte-pièce	243-246
SPURLING Rongeurs	188, 264
STEINBACH Maillet	111
STELLBRINK Pincés-gouges	129
STILLE Pince-gouge	136
STILLE SEMB Pincés-gouges	134
STILLE-LUER Pincés-gouges	134
STRAIGHT Crochets	284
Supports de valves	194

Supports pour trocart	169
SYPERT Rongeur	268
Systèmes d'écarteurs	146-156, 193-231
Systèmes distracteur	233-234

T

TAYLOR CUSHING HM Pince en forme baïonnette	51
TAYLOR CUSHING Pincés en forme baïonnette	51
TAYLOR Ecarteurs spinals	90
TAYLOR Valves	214-215
Thoracoscope	182
Thoracoscope pour la colonne vertébrale	182
THORAMIC	177-190
Titane Micro porte-aiguilles	77
TOENNIS HM Porte-aiguilles	72
TOENNIS Pincés pour préhension de tumeurs	53
Tournevis	236
Tray de nettoyage	320
Trocart	306
Tubes à aspiration	180
TUOHY Canules pour la ponction	81
Tuyaux d'irrigation	315
Tuyaux muraux	319
Tuyaux pour moteur	319

U

UNIVERSAL HM Ciseaux coupe-fil et coupe-plaques Mesh	30
UNIVERSAL Ciseaux coupe-fil et coupe-plaques Mesh	30

V

Valves en acier	206-208, 210-220, 222-223, 227
Valves en aluminium	209
Valves en PEEK	150, 155-156, 197, 200, 205, 221
Valves en titane	195-196, 199, 220, 225
VIPAIR Système de moteur pneumatique	307-320
Vis à distraction	236

W

WAGNER Rongeurs	267-268
WAGNER Rugines	108
WALTER Ecarteurs	280
WEITLANER Ecarteurs autostatiques	92-93
WEITLANER-BECKMANN Ecarteurs autostatiques	95

**E04****Alphabetischer Index**
Alphabetical Index
Índice alfabético
Index alphabétique
Índice alfabético

WILDE Rongeurs	270
WILLIAMS Ecarteurs	231
WILLIGER Rugines	100
WOOD CRILE HM (DEBAKEY HM) Porte-aiguilles	69
WOOD CRILE Porte-aiguilles	69
WOOD CRILE BABY HM Porte-aiguilles	70
WOOD CRILE BABY Porte-aiguilles	69
Y	
YASARGIL Couteaux pour vaisseaux	299
YASARGIL Dissecteur	287
YASARGIL Guides-fils	300
YASARGIL Micro ciseaux	24, 26-28
YASARGIL Micro pinces	47, 49-50
YASARGIL Micro porte-aiguilles	74, 78
YASARGIL Pinces pour saisir des tumeurs	52-53
YASARGIL POTTS Micro ciseaux	24
YASARGIL Rugines	295-297
YASARGIL Tubes à aspiration	82
Z	
ZAUFAL-JANSEN Pinces-gouges	133

A	
Adattatore per spray	320
ADSON HM Pinze delicata	32
ADSON Divaricatori autostatici	94, 96
ADSON Elevatore	100
ADSON JACOBSON Micro pinze	40
ADSON MICRO Pinze delicate	32
ADSON Periostotomi	102
ADSON Pinze delicata	32
ADSON Uncini	283
ADSON-ANDERSON Divaricatori autostatici	94
ADSON BECKMANN Divaricatori autostatici	97
Ago	301
ANDERSON ADSON Divaricatori autostatici	94
AUSTIN Pinze per sutura	56
B	
BABY-CRILE-WOOD HM Portaghi	70
BABY-CRILE-WOOD Portaghi	69
BABY-METZENBAUM	
Forbici per preparazione	15
BACON Pinze sgorbie	130
BARRAQUER Micro portaghi	73
BAUMGARTNER HM Portaghi	67
BECKMANN Divaricatori autostatici	96
BECKMANN-ADSON Divaricatori autostatici	97
BECKMANN-EATON Divaricatori autostatici	98
BECKMANN WEITLANER	
Divaricatori autostatici	95
BEYER Pinza sgorbia	129, 133
BIEMER Micro forbice	23
BIER Cannule per puntura	81
BINNER Bipolatore	183
Bipolatore	170, 183
Bisturi	3-6
Bisturi diamantati	291-293
BÖHM Estrazione spongiosa	303-306
Braccio di supporto	175-176
BRUNS Cucchiari taglienti	122-124
Bussole di foratura	235
Bussola di guida	305
C	
Cacciavite	236
Calibri di profondità	194, 199, 225
Cannule per aspirazione	80, 82-83, 161, 170, 182
Cannule per aspirazione a forma di baionetta	83
Cannule per aspirazione con dispositivo a forma di "goccia"	83
Cannule per puntura	81
CASPAR Contro-divaricatori	226
CASPAR Dissettori	287, 289-290

CASPAR Divaricatori	206, 216-218
CASPAR Micro dissettori	166
CASPAR Periostotomi	101
CASPAR Pestone	113
CASPAR	
Pinze per laminectomia	189, 265-267
CASPAR	
Pinze spezzatrici per dischi intervertebrali	163
CASPAR	
Sistemi di divaricazione	206, 216-218, 226
CASPAR Specoli	181, 226
CASPAR Uncini	206
CASPAR	
Uncini per esplorazione	166, 174, 285
CASPAR Uncini per radici nervose	162, 279
CASPAR Valve	207
Cassetta per punte	320
Cassetta per strumenti	293
CASTROVIEJO HM Micro portaghi	72-73
CASTROVIEJO Portaghi	72
CASTROVIEJO-MICRO Micro portaghi	73
Cavi di connessione bipolari	64
CERVICALINO Sistema di divaricazione	143-150
CITELLI Laminotomi	258
CLINIC LAHEY Uncini	284
CLOWARD Divaricatori	222
CLOWARD Divaricatori vertebrale	228
CLOWARD Pinze per laminectomia	269
CLOWARD Sistemi di divaricazione	222
CLOWARD Valve	223
COBB Periostotomi	107
COBB Sgorbie	119
Coltelli per tumori	297-298
Coltelli per vasi	298-299
Contenitore doppio	320
CONTOUR Divaricatori autostatici	94
Contro-divaricatori	154, 226
COTTLE Martell	110
Craniotomi	313
CRILE Uncini	283
CRILE-WOOD HM (DEBAKEY HM) Portaghi	69
CRILE-WOOD Portaghi	69
CRILE-WOOD BABY HM Portaghi	70
CRILE-WOOD BABY Portaghi	69
Cucchiari (dentellato)	181
Cucchiari taglienti	122-127, 301-302
Curette	302
CUSHING (TAYLOR) HM	
Pinze a forma di baionetta	51
CUSHING (TAYLOR)	
Pinze a forma di baionetta	51
CUSHING HM Pinze anatomiche	35



CUSHING Divaricatore per decompressione	279
CUSHING MICRO	
Pinze per laminectomia	164, 172, 259
CUSHING Periostotomi	103
CUSHING Pinze anatomiche/chirurgiche	35
CUSHING	
Pinze per laminectomia	172, 259, 262
CUSHING Uncini per nervi	273

D

DAHMEN Scalpelli	115
DAHMEN Sgorbie	120-121
DANDY Uncini per radici nervose	276
DAUBENSPECK Cucchiai taglienti	126
DEBAKEY AT Pinze vascolari atraumatiche	36-39
DEBAKEY HM CRILE-WOOD HM Portaghi	69
DENNIS Micro pinze	45
DIETHRICH HEGEMANN Forbici vascolari	19
Dispositivo di tenuta	64
Dissettori	185, 287-290
Dissettori corpo vertebrali	287
Distrattori vertebrali	235
Divaricatore per decompressione	279
Divaricatore per tessuto cervicale	228
Divaricatori	88-91, 146-149, 193, 198, 203-204, 206, 208-213, 216-218, 222, 224, 280
Divaricatori autostatici	92-98
Divaricatori per tessuti molli	91
Divaricatori spinali	90
Divaricatori vertebrali	228-229

E

EATON BECKMANN Divaricatori autostatici	98
ECHLIN Pinze sgorbie	137
EIF Uncini	275
Elettrodo	185
Elevatori	100
Estrazione spongiosa	303-306

F

FERGUSSON FRAZIER	
Cannule per aspirazione	82, 170
FERRIS-SMITH Pinze per laminectomia	261
FERRIS-SMITH-SPURLING	
Pinze per laminectomia	260
FERRIS-SMITH KERRISON Laminotomi	255
FERRIS-SMITH Laminotomi	186
FISCH Uncini	281
Forbici	7-30, 190
Forbici chirurgiche	10-13
Forbici delicate	10, 14-15

Forbici per fili d'acciaio e placche Mesh	30
Forbici per legature	29
Forbici per preparazione	14-18
Forbici per tumori	22
Forbici vascolari	19-20
Forbici micro	20-28, 161, 174
Forbici MICRO 2000	21, 26
Forchetta da sutura	300
FRAZIER (FERGUSSON)	
Cannule per aspirazione	82, 170
FRAZIER Cannule per aspirazione	81-82
FRAZIER Uncini	284
FREER Elevatori	100
FREER Periostotomi	100
FRENCH HAUSER Divaricatori	210
FRENCH HAUSER	
Sistemi di divaricazione	210
Frese	313, 316-318
Frese "Flameshape"	317
Frese a pallina diamantate	316
Frese cilindriche	317
Frese cilindriche diamantate	316
Frese neuro	317
Frese per craniotomo	313
Frese per la dermoabrasione	318
Frese per vertebre	317
FRIEDMANN Pinza sgorbia chirurgica	129

G

GILLIES Pinze delicate	34
GILLIES Uncini	284
GREENBERG PAR	
Forbice per preparazione	14
GRUENWALD LOVE	
Pinze per laminectomia	187, 263
GRUENWALD Pinze a forma di baionetta	51
Guaine per trocar	168
Guidafilo	300
Guida-nodi	183

H

HAJEK Laminotomi	257
HAJEK-KOFLER Pinza tagliente	257
HALLE Cucchiai taglienti	126
HALSEY HM Portaghi	67
HAUSER-FRENCH Sistemi di divaricazione	210
HAVERFIELD SCOVILLE	
Sistemi di divaricazione	213
HEGAR MAYO HM Portaghi	68
HEGEMANN-DIETHRICH Forbici vascolari	19
HM Forbici per legature	29
HUNT Pinza da presa per tumori	52

I	
INGE Divaricatori vertebrale	229
Inseriti lavorativi	313, 315
Interruttore a pedale	319
J	
JACOBSON HM Micro portaghi	74
JACOBSON Coltelli per vasi	298
JACOBSON Forchetta da sutura	300
JACOBSON Micro forbice	24
JACOBSON Micro pinze	43
JACOBSON Micro portaghi	74
JACOBSON Uncini	281
JACOBSON-ADSON Micro pinze	40
JAMESON REYNOLDS Forbici per preparazione	18
JANSEN ZAUFAL Pinza sgorbia	133
JULIAN HM Portaghi	70
JULIAN Portaghi	70
K	
KERRISON "DieBlauen" Laminotomi	165, 173, 239-242
KERRISON (FERRIS-SMITH) Laminotomi	255
KERRISON (MICRO) Laminotomi	248-254, 256
KERRISON (SCHLESINGER) Laminotomi	247
KERRISON (SPURLING) Laminotomi	243-246
KERRISON Laminotomi	165, 173, 239-242, 258
KERRISON Laminotomi smontabili	165, 173, 239-242
KERRISON Laminotomi smontabili cervicale	242
KEY LISTON Pinza ossivora	137
KLEINERT-KUTZ Pinze sgorbie	129
KLIMA-ROSEGGER Cannule per puntura	81
KOCHER MATHIEU HM Portaghi	71
KOFLER HAJEK Laminotomi	257
KOOS Coltelli per vasi	299
KRÄMER Periostotomi	101
KRAYENBÜHL Uncini	275
KUTZ KLEINERT Pinze sgorbie	129
L	
LAHEY-CLINIC Uncini	284
Lame per bisturi	4-6
Laminotomi	165, 173, 186, 237-258
Laminotomi smontabili	165, 173, 239-242
LANDOLT Manici per bisturi	6
LANGENBECK HM Portaghi	72
LEKSELL Pinze sgorbie	135-136
LEMPERT Cucchiali taglienti	125

LEMPERT Pinze sgorbie	130
LEXER MINI Scalpelli	114
LEXER MINI Sgorbie	116
LEXER Scalpelli	114
LEXER Sgorbie	116-118
LISTON-KEY Pinza ossivora	137
LISTON LITTAUER Pinza ossivora	138
LISTON RUSKIN Pinza ossivora	138
LITTAUER-LISTON Pinza ossivora	138
LOVE Uncini per radici nervose	276-278
LOVE-GRUENWALD Pinze per laminectomia	187, 263
LOVE-PAPAVERO Uncini per radici nervose	163, 278
Lubrificante per motore	320
LUCAE Uncini per nervi	272
LUER Pinze sgorbie	130
LUER STILLE Pinze sgorbie	134
M	
Manici per bisturi	3-6
Manico con chiusura rapida	160, 169
MAPN	167-174
MARKHAM-MEYERDING Divaricatori	230
MARQUARDT Pinze sgorbie	133
Martelli	110-112
MATHIEU HM Portaghi	71
MATHIEU Portaghi	71
MATHIEU-KOCHER HM Portaghi	71
MAYO Forbici chirurgiche	13
MAYO HEGAR HM Portaghi	68
MCINDOE Pinze delicate	34
MCINDOE Pinze ossivore	138
MEDICON Braccio di supporto	176
METZENBAUM Forbici per preparazione	16
METZENBAUM-BABY Forbici per preparazione	15
METZENBAUM-SLIM Forbici per preparazione	17
MEYERDING Divaricatori	89
MEYERDING MARKHAM Divaricatori	230
MEYERDING-SCOVILLE Valve	215
MICRO 2000 Forbici	21, 26
MICRO 2000 Micro portaghi	76, 78
MICRO 2000 Pinze	40-42, 48, 54-56
MICRO 2000 Pinze per sutura	54-56
MICRO-ADSON Pinze delicate	32
MICRO CASTROVIEJO Micro portaghi	73
Micro curette	302
Microdissectomia	158-166
MICRODISC-XS	157-166
Micro dissettori	166, 174



MICRO KERRISON	
Laminotomi	248-254, 256
Micro pinze	
per laminectomia	164, 172, 259
MICRO-CUSHING	
Pinze per laminectomia	164, 172, 259
Micro forbici	20-28, 161, 174
Micro forbici MICRO 2000	21, 26
Micro forbici con manico piatto	22-28
Micro forbici con manico rotondo	20, 22, 24
Micro forbici Vannas	20, 23, 28
Micro pinze	39-50
Micro portaghi	72-78
Micro portaghi in titanio	77
MILLESÌ Micro forbice	24
MINI RUSKIN Pinze sgorbie	131
MINI-LEXER Scalpelli	114
MINI-LEXER Sgorbie	116
MINI-RYDER HM Portaghi	70
MISKIMON Divaricatori autostatici	93
Motore angolato	314
Motore con accoppiamento INTRA	311
Motore trapano	312
Motori pneumatici	307-312
MÜHLING Periostotomi	101
N	
NEIVERT HM Portaghi	67
NICOLA Micro forbice	161, 174
O	
OBWEGESER Divaricatori per tessuti molli	91
OLDBERG Pinze per laminectomia	264
P	
PAPAVERO Cannule per aspirazione	161
PAPAVERO LOVE Uncini per radici nervose	163, 278
PEN Cannule per aspirazione	79-80
PEEK Sistema di divaricazione	203-205
Perforatore cavo	305
Perforatore elicoidale	236
Perforatori a spirale	318
Perforatori di Rosen	316
Perforatori per cemento	317
Periostotomi	100-108, 179, 295-297
Pestello	113, 179
PETERSEN SMITH Pinze sgorbie	132
Pinza per cambiare le valve	197, 200, 207, 221
Pinza per tagliare la spongiosa	306
Pinze	31-36, 197
Pinze HM	32, 35, 51
Pinze MICRO 2000	40-42, 48, 54-56

Pinze a forma di baionetta	47-53, 60-63
Pinze anatomiche	32-35
Pinze atraumatiche	36-39
Pinze bipolari	58-63
Pinze bipolari antiaderenti	57-61
Pinze da presa	52-53
Pinze ossivore	137-138
Pinze per afferrare tumori	53
Pinze per applicare	86
Pinze per gioielliere	39
Pinze per laminectomia	163-164, 172, 187-189, 259-270
Pinze per sutura	54-56
Pinze sgorbie	129-137
Pinze spezzatrici per dischi intervertebrali	163
Pinze vascolari atraumatiche	36-37
Portaghi	65-78, 190
Portaghi MICRO 2000	76, 78
Portaghi micro	72-78
POTTS-SMITH Forbici vascolari	19-20
POTTS-SMITH Pinze anatomiche/chirurgiche	34
POTTS-YASARGIL Micro forbice	24
Protezione antispruzzo per la dermoabrasione	318
Punte per perforatore	313

Q

QUINCKE Cannule per puntura	81
-----------------------------	----

R

REYNOLDS (JAMESON)	
Forbici per preparazione	18
RETRACT Sistema di divaricazione	201-205
RHOTON Ago	301
RHOTON Cucchiali taglienti	301
RHOTON Dissettori	288
RHOTON Periostotomi	296
RHOTON Uncini	282
ROSEGGER KLIMA Cannule per puntura	81
RUSKIN Pinze sgorbie	131-132
RUSKIN-LISTON Pinze ossivore	138
RUSKIN-MINI Pinze sgorbie	131
RYDER MINI HM Portaghi	70

S

SAMII Coltelli per tumori	298
Scalpelli	114-115, 180
SCHLESINGER KERRISON Laminotomi	247
SCHLESINGER Pinze per laminectomia	269
SCOVILLE Cucchiali taglienti	127
SCOVILLE-HAVERFIELD	
Sistema di divaricazione	213
SCOVILLE MEYERDING Valve	215

SCOVILLE Sistema di divaricazione	213
SCOVILLE Uncini per radici nervose	277
SCOVILLE Uncini in acciaio	214
SCOVILLE Valve in acciaio	215
SEDILLOT Periostotomi	102
SELECT Pinze delicate	33
SEMB-STILLE Pinze sgorbie	134
SEMKEN Pinze delicate	33
Set per dilatazione	160, 170
Sgorbie	116-121
SHEA Forbici per preparazione	14
SIDE-LOAD Divaricatori	224
Sisteme distrattore	233
Sistemi di divaricazione	146-156, 193-231
SLIM Forbici per preparazione	15, 17
SLIM METZENBAUM Forbici per preparazione	17
SMITH FERRIS KERRISON Laminotomi	255
SMITH FERRIS Laminotomi	186
SMITH FERRIS Pinze per laminectomia	261
SMITH POTTS Forbici vascolari	19-20
SMITH POTTS Pinze anatomiche/chirurgiche	34
SMITH-PETERSEN Pinze sgorbie	132
SMITH FERRIS SPURLING Pinze per laminectomia	260
SMITHWICK Uncino per simpatectomia	285
Spatole in titanio	184
Spatole ugola	286
Specoli	155, 181, 226
Specoli divaricabili	159
SPREAD-IT Sistema di divaricazione	191-200
SPURLING FERRIS-SMITH Pinze per laminectomia	260
SPURLING KERRISON Laminotomi	243-246
SPURLING Pinze per laminectomia	188, 264
STEINBACH Martello	111
STELLBRINK Pinze sgorbie	129
STILLE Pinza sgorbia	136
STILLE SEMB Pinze sgorbie	134
STILLE-LUER Pinze sgorbie	134
STRAIGHT Uncini	284
Strumenti micro	295-302
Strumenti per aspirazione e lavaggio	79-83, 161, 170, 180
Supporti per trocar	169
Supporti valve	194
Supporto di pulizia	320
SYPERT Pinza per laminectomia	268
T	
TAYLOR CUSHING HM Pinza a forma di baionetta	51
TAYLOR CUSHING Pinze a forma di baionetta	51

TAYLOR Divaricatori spinali	90
TAYLOR Valve	214-215
Titanio micro portaghi	77
Titanio clips	85
THORAMIC	177-190
TOENNIS HM Portaghi	72
TOENNIS Pinze per afferrare tumori	53
Toracoscopio	182
Toracoscopio per la colonna vertebrale	182
Trocar	306
Tubi da parete	319
Tubi di alimentazione	319
Tubi d'irrigazione	315
Tubo motore	319
TUOHY Cannule per puntura	81
U	
Uncini	162-163, 166, 171, 271-286
Uncini per dura-madre	283
Uncini per esplorazione	166, 174, 285
Uncini per nervi	171, 272-275
Uncini per pelle	283
Uncini per radici nervose	162-163, 171, 276-279
Uncini per vasi	275
Uncino per simpatectomia	285
UNIVERSAL HM Forbici per fili d'acciaio e placche Mesh	30
UNIVERSAL Forbici per fili d'acciaio e placche Mesh	30
V	
Valve in acciaio	206-208, 210-220, 222-223, 227
Valve in alluminio	209
Valve in PEEK	150, 155-156, 197, 200, 205, 221
Valve in titanio	195-196, 199, 220, 225
VIPAIR Sistema motore pneumatico	307-320
Viti di distrezione	236
W	
WAGNER Periostotomi	108
WAGNER Pinze per laminectomia	267-268
WALTER Divaricatori	280
WEITLANER Divaricatori autostatici	92-93
WEITLANER-BECKMANN Divaricatori autostatici	95
WILDE Pinze per laminectomia	270
WILLIAMS Divaricatori	231
WILLIGER Periostotomi	100
WOOD CRILE HM (DEBAKEY HM) Portaghi	69
WOOD CRILE Portaghi	69

**E05****Alphabetischer Index**
Alphabetical Index
Índice alfabético
Index alphabétique
Índice alfabético

WOOD CRILE BABY HM Portaghi	70
WOOD CRILE BABY Portaghi	69
Y	
YASARGIL Cannule per aspirazione	82
YASARGIL Coltelli per vasi	299
YASARGIL Dissetore	287
YASARGIL Guidafile	300
YASARGIL Micro forbice	24, 26-28
YASARGIL Micro pinze	47, 49-50
YASARGIL Micro portaghi	74, 78
YASARGIL Periostotomi	295-297
YASARGIL Pinze da presa per tumori	52-53
YASARGIL POTTS Micro forbice	24
Z	
ZAUFAL-JANSEN Pinza sgorbia	133

MEDICONTAINER CONTAINER System



**E06**

Numerischer Index
Numerical Index
Indice numérico
Index numérique
Indice numerico

01.22.10	4	03.50.14	13	05.15.70	21	06.20.62	32
01.22.11	4	03.50.17	13	05.15.71	21	06.20.65	32
01.22.12	4	03.50.64	13	05.15.72	21	06.21.12	32
01.22.15	4	03.50.67	13	05.15.73	21	06.21.13	32
01.22.20	5	03.51.14	13	05.15.74	20	06.21.62	32
01.22.21	5	03.51.17	13	05.15.75	20	06.21.65	32
01.22.25	5	03.51.64	13	05.15.76	20	06.22.12	32
01.22.32	4	03.51.67	13	05.15.77	20	06.22.15	32
01.22.35	4	04.13.12	14	05.15.81	21	06.23.12	32
01.27.03	4	04.24.14	15	05.15.83	21	06.23.15	32
01.27.07	4	04.24.64	15	05.16.68	22	06.30.12	33
01.27.21	6	04.25.14	15	05.16.69	22	06.30.15	33
01.27.25	6	04.25.64	15	05.16.74	22	06.30.22	33
01.27.40	4	04.32.11	15	05.16.75	22	06.30.25	33
01.28.04	5	04.32.14	16	05.18.68	22	06.31.12	33
01.28.14	5	04.32.18	16	05.18.69	22	06.31.15	33
01.28.45	5	04.32.20	16	05.18.70	21	06.31.22	33
01.30.36	6	04.32.61	15	05.18.71	21	06.31.25	33
01.30.37	6	04.32.64	16	05.18.72	21	06.31.32	33
01.30.62	6	04.32.68	16	05.18.73	21	06.34.55	33
01.30.64	6	04.32.70	16	05.18.74	22	06.34.58	33
01.30.65	6	04.33.11	15	05.18.75	22	06.34.60	33
01.30.67	6	04.33.14	16	05.18.81	21	06.35.55	33
01.30.69	6	04.33.18	16	05.18.83	21	06.35.58	33
02.50.45	10	04.33.20	16	05.18.84	23	06.35.60	33
03.02.14	10	04.33.61	15	05.18.85	23	06.40.15	34
03.02.16	10	04.33.64	16	05.18.86	23	06.40.85	34
03.02.64	10	04.33.68	16	05.18.87	23	06.46.18	34
03.02.84	13	04.33.70	16	05.18.89	23	06.46.20	34
03.03.14	10	04.34.14	17	05.18.90	23	06.46.25	34
03.03.16	10	04.34.18	17	05.18.92	23	06.48.18	34
03.03.64	10	04.34.20	17	05.18.93	23	06.48.20	34
03.03.84	13	04.34.64	17	05.18.94	23	06.48.25	34
03.04.14	11	04.34.68	17	05.18.95	23	06.50.15	36
03.04.16	11	04.34.70	17	05.18.96	24	06.50.19	36
03.04.64	11	04.35.14	17	05.18.97	24	06.50.24	36
03.04.84	12	04.35.18	17	05.18.98	24	06.50.30	36
03.05.14	11	04.35.20	17	05.18.99	24	06.51.15	37
03.05.16	11	04.35.64	17	05.19.01	24	06.51.20	37
03.05.64	11	04.35.68	17	05.19.02	25	06.52.15	36
03.05.84	12	04.35.70	17	05.19.10	25	06.52.19	36
03.06.14	11	04.66.12	18	05.19.25	25	06.52.24	36
03.06.16	11	04.66.14	18	05.19.45	25	06.52.30	36
03.06.64	11	04.66.16	18	05.19.60	25	06.54.15	36
03.06.84	12	04.66.18	18	05.21.68	22	06.54.19	36
03.07.14	11	04.67.12	18	05.21.69	22	06.54.24	36
03.07.16	11	04.67.14	18	05.21.74	22	06.54.30	36
03.07.64	11	04.67.16	18	05.21.75	22	06.55.15	36
03.07.84	12	04.67.18	18	06.20.12	32	06.55.19	36



Numerischer Index
Numerical Index
Indice numérico
Index numérique
Indice numerico

06.55.24	36	07.64.03	41	09.83.62	82	10.18.88	68
06.55.30	36	07.64.04	41	09.83.73	82	10.18.90	68
06.60.17	35	07.64.13	41	09.83.76	82	10.18.93	68
06.60.18	35	07.64.14	41	09.83.78	82	10.20.14	69
06.60.68	35	07.64.63	42	09.83.80	82	10.20.15	69
06.60.69	35	07.64.64	42	09.83.82	82	10.20.18	69
06.60.87	35	07.64.73	42	09.83.93	161	10.20.20	69
06.60.88	35	07.64.74	42	09.83.94	161	10.20.23	69
06.62.15	37	07.64.83	42	09.83.95	161	10.20.64	70
06.62.19	37	07.64.84	42	09.83.96	161	10.20.65	69
06.62.24	37	07.64.93	42	09.83.97	161	10.20.68	69
06.64.15	37	07.64.94	42	09.83.98	161	10.20.70	69
06.64.19	37	07.66.12	40	09.83.99	83	10.20.73	69
06.64.24	37	07.66.15	40	09.84.13	82	10.20.75	69
06.70.15	38	07.70.11	43	09.84.15	82	10.20.76	69
06.70.20	38	07.70.15	43	09.84.18	82	10.20.80	69
06.70.24	38	07.70.18	43	09.84.22	82	10.21.20	70
06.72.15	38	07.72.19	41	09.84.23	82	10.21.23	70
06.72.20	38	07.74.15	44	09.84.25	82	10.21.70	70
06.72.24	38	07.74.18	44	09.84.28	82	10.21.73	70
06.74.15	38	07.74.21	44	09.84.32	82	10.28.63	70
06.74.20	38	07.75.20	47	09.84.33	82	10.28.65	70
06.74.24	38	07.75.30	43	09.84.35	82	10.28.68	70
06.90.15	39	07.75.31	43	09.84.38	82	10.28.70	70
06.90.18	39	07.75.32	43	09.84.42	82	10.28.73	70
06.90.21	39	07.75.40	48	09.84.43	82	11.18.64	71
06.92.15	39	07.75.42	48	09.84.45	82	11.18.67	71
06.92.18	39	07.75.43	48	09.84.48	82	11.18.70	71
06.92.21	39	07.76.15	44	09.84.52	82	11.20.14	71
07.26.18	51	07.76.18	44	09.86.30	182	11.20.17	71
07.26.19	51	07.76.21	44	09.86.31	182	11.20.20	71
07.26.68	51	09.70.18	81	09.99.01	80	11.20.64	71
07.27.18	51	09.72.07	81	09.99.07	80	11.20.67	71
07.30.16	51	09.72.08	81	09.99.08	80	11.20.70	71
07.30.19	51	09.72.10	81	09.99.09	80	11.20.74	71
07.31.16	51	09.72.11	81	09.99.11	80	11.34.66	72
07.31.19	51	09.72.12	81	09.99.12	80	11.34.68	72
07.60.03	39	09.72.13	81	09.99.13	80	11.34.70	72
07.60.04	39	09.72.14	81	10.08.62	67	11.36.66	72
07.60.05	39	09.73.12	81	10.10.63	67	11.36.68	72
07.60.07	39	09.73.14	81	10.14.64	67	11.36.70	72
07.60.10	40	09.73.16	81	10.18.65	68	11.62.14	72
07.61.05	40	09.73.92	81	10.18.68	68	11.62.15	72
07.61.06	40	09.73.93	81	10.18.70	68	11.62.17	72
07.61.11	41	09.83.28	170	10.18.73	68	11.62.18	72
07.61.12	41	09.83.30	170	10.18.74	68	11.62.63	72
07.61.14	41	09.83.56	82	10.18.76	68	11.62.64	73
07.63.31	40	09.83.58	82	10.18.80	68	11.62.67	73
07.63.32	40	09.83.60	82	10.18.85	68	11.62.84	73

**E06**

Numerischer Index
Numerical Index
Indice numérico
Index numérique
Indice numerico

11.62.87	73	12.16.76	77	13.70.42	54	23.25.34	90
11.70.22	73	12.16.77	77	13.70.72	56	23.25.35	90
11.70.23	73	12.16.78	77	13.70.74	56	23.63.01	89
11.70.24	73	12.18.56	75	13.71.22	56	23.63.02	89
11.70.25	73	12.18.57	75	13.71.23	56	23.63.03	89
11.74.13	73	12.18.60	75	13.71.42	55	24.22.13	92
11.74.15	73	12.18.61	75	13.71.43	55	24.22.14	92
11.74.23	73	12.18.66	75	13.71.50	54	24.22.16	92
11.74.25	73	12.18.67	75	13.71.52	54	24.22.17	92
11.80.68	74	12.18.68	75	13.71.60	54	24.22.20	92
11.80.71	74	12.18.69	75	13.71.62	54	24.22.21	92
11.82.18	74	12.18.70	76	13.71.70	54	24.22.24	92
11.82.21	74	12.18.71	76	13.71.72	54	24.22.25	92
11.82.68	74	12.18.72	76	13.71.82	55	24.22.26	93
11.82.71	74	12.18.73	76	13.71.83	55	24.22.27	93
11.84.68	74	12.18.74	76	13.71.84	56	24.26.70	94
11.85.68	74	12.18.75	76	13.71.86	56	24.28.01	94
11.86.68	74	12.18.76	75	14.06.84	29	24.28.02	94
11.87.68	74	12.18.77	75	14.06.88	29	24.28.03	94
12.12.40	78	12.18.78	75	14.06.93	29	24.28.10	93
12.12.41	78	12.18.79	75	14.23.12	30	24.30.13	95
12.12.42	78	12.18.80	75	14.23.62	30	24.30.14	95
12.12.43	78	12.18.81	75	20.17.01	276	24.30.16	95
12.12.48	78	12.18.82	75	20.17.02	276	24.30.17	95
12.12.54	75	12.18.83	75	20.17.03	276	24.30.20	95
12.12.55	75	12.18.85	77	20.20.34	272	24.30.21	95
12.12.56	75	12.18.86	77	20.20.57	272	24.32.04	96
12.12.57	75	12.18.87	77	20.20.59	272	24.32.06	96
12.12.59	75	12.18.88	77	20.22.01	272	24.34.25	97
12.12.61	75	12.21.56	75	20.22.02	272	24.34.26	97
12.15.30	76	12.21.57	75	20.22.03	272	24.34.45	97
12.15.31	76	12.21.60	75	20.22.31	273	24.34.46	97
12.15.32	76	12.21.61	75	20.22.32	273	24.34.50	98
12.15.33	76	12.21.66	75	20.22.36	273	24.45.90	230
12.15.50	74	12.21.67	75	20.22.37	273	24.45.91	230
12.15.51	74	12.21.70	75	20.27.22	283	26.35.01	100
12.15.56	75	12.21.71	75	20.27.23	283	26.35.02	100
12.15.57	75	12.21.76	75	20.27.37	283	26.35.03	100
12.15.66	75	12.21.77	75	20.30.12	284	26.42.03	100
12.15.67	75	12.21.78	75	20.30.19	284	26.42.05	100
12.15.70	76	12.21.79	75	20.30.20	284	26.42.07	100
12.15.71	76	12.21.80	75	20.31.13	284	26.47.01	101
12.15.72	76	12.21.81	75	20.31.15	284	26.47.02	101
12.15.73	76	12.21.82	75	23.25.20	88	26.47.11	101
12.15.76	75	12.21.83	75	23.25.21	88	26.47.12	101
12.15.77	75	12.21.95	77	23.25.22	88	26.47.32	101
12.15.78	75	12.21.96	77	23.25.23	88	26.47.33	101
12.15.79	75	12.21.97	77	23.25.24	88	26.47.35	102
12.16.75	77	12.21.98	77	23.25.32	90	26.47.38	102



Numerischer Index
Numerical Index
Indice numérico
Index numérique
Indice numerico

26.48.01	102	27.10.51	111	28.62.15P	116	28.66.06	115
26.48.02	100	27.10.60	111	28.62.20	116	28.66.06P	115
26.48.03	102	27.10.61	111	28.62.20P	116	28.66.08	115
26.48.04	102	27.10.70	112	28.64.07	114	28.66.08P	115
26.62.01	103	27.10.71	112	28.64.07P	114	28.66.10	115
26.62.02	103	27.10.72	112	28.64.10	114	28.66.10P	115
26.64.06	104	27.10.73	112	28.64.10P	114	28.66.12	115
26.64.06P	104	27.95.15	113	28.64.12	114	28.66.12P	115
26.64.13	104	27.95.15P	113	28.64.12P	114	28.66.15	115
26.64.13P	104	27.95.16	113	28.64.15	114	28.66.15P	115
26.64.16	104	27.95.16P	113	28.64.15P	114	28.66.20	115
26.64.16P	104	27.95.17	113	28.64.20	114	28.66.20P	115
26.64.26	104	27.95.17P	113	28.64.20P	114	28.66.22	115
26.64.26P	104	27.95.20	113	28.64.25	114	28.66.22P	115
26.64.73	105	27.95.20P	113	28.64.25P	114	28.66.25	115
26.64.75P	105	27.95.21	113	28.64.30	114	28.66.25P	115
26.64.84	106	27.95.21P	113	28.64.30P	114	28.67.06	120
26.64.86P	106	27.95.22	113	28.65.07	116	28.67.06P	120
26.64.94	106	27.95.22P	113	28.65.07P	116	28.67.08	120
26.64.96P	106	27.95.30	179	28.65.10	116	28.67.08P	120
26.65.10	107	28.61.02	114	28.65.10P	116	28.67.10	120
26.65.10P	107	28.61.02P	114	28.65.12	116	28.67.10P	120
26.65.13	107	28.61.04	114	28.65.12P	116	28.67.12	120
26.65.13P	107	28.61.04P	114	28.65.15	116	28.67.12P	120
26.65.19	107	28.61.06	114	28.65.15P	116	28.67.15	120
26.65.19P	107	28.61.06P	114	28.65.20	116	28.67.15P	120
26.65.25	107	28.61.08	114	28.65.20P	116	28.67.20	120
26.65.25P	107	28.61.08P	114	28.65.25	116	28.67.20P	120
26.67.27	108	28.61.10	114	28.65.25P	116	28.67.22	120
26.67.27P	108	28.61.10P	114	28.65.30	116	28.67.22P	120
26.67.33	108	28.61.12	114	28.65.30P	116	28.67.25	120
26.67.33P	108	28.61.12P	114	28.65.55	117	28.67.25P	120
26.67.34	108	28.61.15	114	28.65.55P	117	28.67.36	121
26.67.34P	108	28.61.15P	114	28.65.60	117	28.67.36P	121
26.68.20	105	28.61.20	114	28.65.60P	117	28.67.38	121
26.68.20P	105	28.61.20P	114	28.65.65	117	28.67.38P	121
26.73.09	103	28.62.02	116	28.65.65P	117	28.67.40	121
26.73.13	103	28.62.02P	116	28.65.75	118	28.67.40P	121
26.73.19	103	28.62.04	116	28.65.75P	118	28.67.42	121
26.74.19	179	28.62.04P	116	28.65.80	118	28.67.42P	121
27.06.20	110	28.62.06	116	28.65.80P	118	28.67.45	121
27.06.21	110	28.62.06P	116	28.65.85	118	28.67.45P	121
27.09.19	110	28.62.08	116	28.65.85P	118	28.67.50	121
27.09.25	110	28.62.08P	116	28.65.91	119	28.67.50P	121
27.10.31	111	28.62.10	116	28.65.91P	119	28.67.52	121
27.10.32	111	28.62.10P	116	28.65.92	119	28.67.52P	121
27.10.33	111	28.62.12	116	28.65.92P	119	28.67.55	121
27.10.35	111	28.62.12P	116	28.65.93	119	28.67.55P	121
27.10.50	111	28.62.15	116	28.65.93P	119	28.68.00	180

**E06**

Numerischer Index
Numerical Index
Indice numérico
Index numérique
Indice numerico

28.68.02	180	29.57.55P	123	31.11.05	133	56.50.29	86
28.68.04	180	29.57.56	123	31.11.13	133	56.50.30	86
29.55.24	124	29.57.56P	123	31.30.23	134	56.50.40	86
29.55.33	124	29.57.70	181	31.30.24	134	57.03.02	243
29.55.42	124	29.57.73	181	31.31.23	134	57.03.03	243
29.55.50	124	29.57.74	181	31.31.24	134	57.03.04	243
29.55.51	124	29.57.76	181	31.31.53	134	57.03.05	243
29.55.52	124	29.57.78	181	31.31.57	134	57.03.06	243
29.55.53	124	29.57.83	181	31.31.83	136	57.03.23	244
29.55.54	124	29.67.06	125	31.51.05	135	57.03.24	244
29.55.55	124	29.67.15	125	31.51.08	135	57.03.25	244
29.55.56	124	29.67.24	125	31.53.03	135	57.03.26	244
29.56.24	122	29.67.33	125	31.53.05	135	57.04.02	243
29.56.24P	122	29.67.42	125	31.53.08	135	57.04.03	243
29.56.33	122	29.67.50	125	31.54.03	136	57.04.04	243
29.56.33P	122	29.67.51	125	31.54.05	136	57.04.05	243
29.56.42	122	29.67.52	125	31.54.08	136	57.04.06	243
29.56.42P	122	29.68.42	126	31.61.02	137	57.04.12	243
29.56.50	122	29.68.50	126	31.61.03	137	57.04.13	243
29.56.50P	122	29.68.51	126	31.61.04	137	57.04.14	243
29.56.51	122	29.68.52	126	33.02.15	138	57.04.15	243
29.56.51P	122	29.69.51	126	33.56.18	138	57.04.16	243
29.56.52	122	29.69.52	126	33.57.18	138	57.04.23	244
29.56.52P	122	29.69.53	126	33.58.18	138	57.04.24	244
29.56.53	122	30.05.14	129	33.59.17	138	57.04.25	244
29.56.53P	122	30.52.17	130	33.59.18	138	57.04.26	244
29.56.54	122	30.52.18	130	33.75.27	137	57.04.43	245
29.56.54P	122	30.53.18	130	45.53.80	286	57.04.45	245
29.56.55	122	30.54.70	130	45.53.81	286	57.04.53	245
29.56.55P	122	30.71.02	129	49.90.00	320	57.04.55	245
29.56.56	122	30.71.03	129	49.90.04	293	57.04.73	244
29.56.56P	122	30.76.13	129	55.15.32	19	57.04.74	244
29.57.24	123	30.76.14	129	55.15.34	19	57.04.75	244
29.57.24P	123	30.76.17	129	55.15.36	19	57.04.76	244
29.57.33	123	30.76.18	129	55.15.42	20	57.05.12	243
29.57.33P	123	30.76.19	130	55.15.44	20	57.05.13	243
29.57.42	123	30.76.29	130	55.15.46	20	57.05.14	243
29.57.42P	123	31.04.02	131	55.15.50	19	57.05.15	243
29.57.50	123	31.04.03	131	55.15.51	19	57.05.16	243
29.57.50P	123	31.05.02	131	56.50.01	85	57.06.43	247
29.57.51	123	31.05.03	131	56.50.02	85	57.06.45	247
29.57.51P	123	31.06.05	131	56.50.03	85	57.06.53	246
29.57.52	123	31.06.25	132	56.50.04	85	57.06.55	246
29.57.52P	123	31.07.05	131	56.50.11	85	57.06.57	246
29.57.53	123	31.07.25	132	56.50.12	85	57.06.59	246
29.57.53P	123	31.09.03	132	56.50.14	85	57.06.63	246
29.57.54	123	31.09.13	132	56.50.15	86	57.06.65	246
29.57.54P	123	31.09.23	132	56.50.19	86	57.06.67	246
29.57.55	123	31.11.04	133	56.50.25	86	57.06.69	246



E06

**Numerischer Index
Numerical Index
Indice numérico
Index numérique
Indice numerico**

57.06.73	247	57.07.72	249	57.08.83	251	57.11.14	256
57.06.75	247	57.07.73	249	57.08.84	251	57.11.15	256
57.06.83	247	57.07.74	249	57.08.85	251	57.11.26	256
57.06.85	247	57.07.75	249	57.08.86	251	57.11.27	256
57.06.93	247	57.07.76	249	57.08.91	251	57.11.28	256
57.06.95	247	57.07.77	254	57.08.92	251	57.11.29	256
57.07.01	248	57.07.78	254	57.08.93	251	57.11.30	256
57.07.02	248	57.07.79	254	57.08.94	251	57.11.39	256
57.07.03	248	57.07.80	254	57.08.95	251	57.11.40	256
57.07.04	248	57.07.81	254	57.08.96	251	57.11.41	256
57.07.05	248	57.07.82	254	57.09.30	252	57.11.42	256
57.07.06	248	57.08.21	250	57.09.31	252	57.11.51	256
57.07.11	248	57.08.22	250	57.09.32	252	57.11.52	256
57.07.12	248	57.08.23	250	57.09.33	252	57.11.53	256
57.07.13	248	57.08.24	250	57.09.34	252	57.11.54	256
57.07.14	248	57.08.25	250	57.09.45	252	57.11.80	164, 172, 259
57.07.15	248	57.08.26	250	57.09.46	252	57.11.81	164, 172, 259
57.07.16	248	57.08.31	250	57.09.47	252	57.11.82	164, 172, 259
57.07.21	249	57.08.32	250	57.09.48	252	57.11.90	172, 259
57.07.22	249	57.08.33	250	57.09.49	252	57.11.91	172, 259
57.07.23	249	57.08.34	250	57.09.50	253	57.12.01	168
57.07.24	249	57.08.35	250	57.09.51	253	57.12.02	168
57.07.25	249	57.08.36	250	57.09.52	253	57.12.03	168
57.07.26	249	57.08.41	251	57.09.53	253	57.12.05	169
57.07.31	249	57.08.42	251	57.09.54	253	57.12.06	160, 169
57.07.32	249	57.08.43	251	57.09.55	253	57.12.07	176
57.07.33	249	57.08.44	251	57.09.56	253	57.12.08	169
57.07.34	249	57.08.45	251	57.09.57	253	57.12.10	170
57.07.35	249	57.08.46	251	57.09.58	252	57.12.11	159
57.07.36	249	57.08.51	251	57.09.59	252	57.12.12	159
57.07.41	248	57.08.52	251	57.09.60	252	57.12.13	159
57.07.42	248	57.08.53	251	57.09.61	252	57.12.14	159
57.07.43	248	57.08.54	251	57.09.62	253	57.12.15	159
57.07.44	248	57.08.55	251	57.09.63	253	57.12.16	159
57.07.45	248	57.08.56	251	57.09.64	253	57.12.17	159
57.07.46	248	57.08.61	250	57.09.65	253	57.12.18	159
57.07.51	248	57.08.62	250	57.09.66	253	57.12.20	260
57.07.52	248	57.08.63	250	57.09.67	253	57.12.30	260
57.07.53	248	57.08.64	250	57.09.68	253	57.12.31	159
57.07.54	248	57.08.65	250	57.09.69	253	57.12.32	159
57.07.55	248	57.08.66	250	57.09.70	252	57.12.33	159
57.07.56	248	57.08.71	250	57.09.71	252	57.12.34	159
57.07.61	249	57.08.72	250	57.09.72	252	57.12.35	159
57.07.62	249	57.08.73	250	57.09.73	252	57.12.36	159
57.07.63	249	57.08.74	250	57.10.05	255	57.12.37	159
57.07.64	249	57.08.75	250	57.10.15	255	57.12.38	159
57.07.65	249	57.08.76	250	57.11.11	256	57.12.40	260
57.07.66	249	57.08.81	251	57.11.12	256	57.12.62	260
57.07.71	249	57.08.82	251	57.11.13	256	57.12.70	160

**E06**

Numerischer Index
Numerical Index
Indice numérico
Index numérique
Indice numerico

57.12.75	160	57.22.14	264	57.23.75	266	57.28.16	239
57.12.76	160	57.22.24	264	57.23.83	266	57.28.21	239
57.12.90	175	57.22.34	264	57.23.84	266	57.28.22	239
57.13.01	168	57.22.44	264	57.23.87	267	57.28.23	239
57.13.02	168	57.22.54	264	57.23.90	267	57.28.24	239
57.13.03	168	57.22.64	264	57.23.91	268	57.28.25	239
57.13.05	169	57.22.74	264	57.23.93	268	57.28.26	239
57.13.08	169	57.22.84	264	57.24.32	269	57.28.31	239
57.13.10	170	57.22.86	264	57.24.33	269	57.28.32	239
57.13.20	260	57.22.90	264	57.24.34	269	57.28.33	239
57.13.30	260	57.22.92	264	57.24.40	269	57.28.34	239
57.13.40	260	57.22.93	264	57.24.43	269	57.28.35	239
57.14.20	260	57.22.94	264	57.24.45	269	57.28.36	239
57.14.30	260	57.22.95	264	57.24.61	270	57.28.41	240
57.14.40	260	57.22.96	264	57.24.62	270	57.28.42	240
57.15.00	261	57.23.02	265	57.24.63	270	57.28.43	240
57.15.30	261	57.23.03	265	57.24.66	270	57.28.44	240
57.15.60	261	57.23.04	265	57.24.67	270	57.28.45	240
57.20.02	262	57.23.05	265	57.24.68	270	57.28.46	240
57.20.12	262	57.23.12	265	57.24.71	270	57.28.51	165
57.20.22	262	57.23.13	265	57.24.72	270	57.28.51	173
57.20.32	262	57.23.14	265	57.24.73	270	57.28.51	240
57.20.42	262	57.23.22	265	57.24.76	270	57.28.52	165
57.20.52	262	57.23.23	265	57.24.77	270	57.28.52	173
57.20.62	262	57.23.24	265	57.24.78	270	57.28.52	240
57.20.72	262	57.23.27	266	57.26.00	182	57.28.53	165
57.20.82	262	57.23.28	266	57.26.04	186	57.28.53	173
57.20.84	262	57.23.29	266	57.26.10	186	57.28.53	240
57.20.86	262	57.23.32	266	57.26.16	186	57.28.54	165
57.20.88	262	57.23.33	266	57.26.30	187	57.28.54	173
57.20.90	262	57.23.34	266	57.26.31	187	57.28.54	240
57.20.92	262	57.23.35	266	57.26.32	187	57.28.55	165
57.20.94	262	57.23.36	266	57.26.40	188	57.28.55	173
57.21.03	263	57.23.40	266	57.26.41	188	57.28.55	240
57.21.13	263	57.23.41	266	57.26.42	188	57.28.56	165
57.21.23	263	57.23.43	266	57.26.53	189	57.28.56	173
57.21.33	263	57.23.44	266	57.27.91	239	57.28.56	240
57.21.43	263	57.23.45	266	57.27.92	239	57.28.61	165, 173, 240
57.21.53	263	57.23.51	266	57.28.01	239	57.28.62	165, 173, 240
57.21.63	263	57.23.52	266	57.28.02	239	57.28.63	165, 173, 240
57.21.73	263	57.23.53	266	57.28.03	239	57.28.64	165, 173, 240
57.21.75	263	57.23.54	266	57.28.04	239	57.28.65	165, 173, 240
57.21.77	263	57.23.62	163, 266	57.28.05	239	57.28.66	165, 173, 240
57.21.79	263	57.23.63	163, 266	57.28.06	239	57.28.71	241
57.21.83	263	57.23.64	163, 266	57.28.11	239	57.28.72	241
57.21.85	263	57.23.65	266	57.28.12	239	57.28.73	241
57.21.87	263	57.23.66	266	57.28.13	239	57.28.74	241
57.21.89	263	57.23.73	266	57.28.14	239	57.28.75	241
57.22.04	264	57.23.74	266	57.28.15	239	57.28.76	241



Numerischer Index
Numerical Index
Indice numérico
Index numérique
Indice numerico

57.28.91	165	57.50.40	285	57.53.53	209	57.56.00	222
57.28.91	173	57.50.50	277	57.53.55	209	57.56.01	222
57.28.91	165, 173, 241	57.50.51	277	57.53.56	209	57.56.10	222
57.28.92	165, 173, 241	57.50.60	277	57.53.57	209	57.56.11	222
57.28.93	165, 173, 241	57.50.62	162, 171	57.53.90	210	57.56.31	222, 223
57.28.94	165, 173, 241	57.50.64	278	57.53.91	210	57.56.32	222, 223
57.28.95	165, 173, 241	57.50.65	278	57.53.92	210	57.56.33	222, 223
57.28.96	165, 173, 241	57.50.67	278	57.53.93	210	57.56.34	222, 223
57.29.07	53	57.50.68	163, 278	57.53.94	210	57.56.35	222, 223
57.29.10	53	57.50.70	163, 278	57.53.95	210	57.56.41	222, 223
57.29.12	53	57.52.05	279	57.53.96	210	57.56.42	222, 223
57.29.30	184	57.53.00	206	57.53.97	210	57.56.43	222, 223
57.29.32	184	57.53.01	206	57.54.07	90	57.56.44	222, 223
57.29.35	184	57.53.03	206	57.54.10	90	57.56.45	222, 223
57.29.36	184	57.53.04	206	57.54.14	162, 279	57.56.60	211
57.29.38	184	57.53.05	207	57.54.16	279	57.56.61	211
57.30.21	242	57.53.06	206, 207	57.54.18	279	57.56.63	211
57.30.22	242	57.53.07	206, 207	57.54.20	279	57.56.64	211
57.30.23	242	57.53.08	206, 207	57.55.05	229	57.56.65	211
57.30.24	242	57.53.09	206, 207	57.55.06	229	57.56.67	211
57.30.31	242	57.53.10	206, 207	57.55.07	229	57.56.69	193, 194
57.30.32	242	57.53.11	207	57.55.10	233	57.56.70	193
57.30.33	242	57.53.12	207	57.55.11	233, 235	57.56.71	193, 194
57.30.34	242	57.53.13	207	57.55.12	234	57.56.74	193, 194
57.30.51	242	57.53.14	207	57.55.13	234, 235	57.56.75	195
57.30.52	242	57.53.15	207	57.55.14	233, 235	57.56.76	193, 195
57.30.53	242	57.53.16	207	57.55.15	234, 235	57.56.77	193, 195
57.30.54	242	57.53.17	207	57.55.18	233, 234, 236	57.56.78	193, 195
57.30.61	242	57.53.18	207	57.55.19	233, 234, 236	57.56.79	193, 195
57.30.62	242	57.53.19	207	57.55.20	236	57.56.80	195
57.30.63	242	57.53.20	207	57.55.21	236	57.56.81	193, 196
57.30.64	242	57.53.21	207	57.55.22	233, 234, 236	57.56.82	193, 196
57.35.17	287	57.53.22	207	57.55.23	236	57.56.84	193, 196
57.35.18	287	57.53.23	207	57.55.24	236	57.56.85	193, 196
57.39.02	81	57.53.24	207	57.55.30	231	57.56.87	193, 196
57.43.01	127	57.53.25	207	57.55.31	231	57.56.88	193, 196
57.43.02	127	57.53.26	207	57.55.32	231	57.56.90	193, 196
57.43.03	127	57.53.27	207	57.55.33	231	57.56.91	193, 196
57.49.10	275	57.53.28	207	57.55.34	231	57.56.93	193, 196
57.49.19	274	57.53.40	208	57.55.35	231	57.56.94	193, 196
57.49.20	274	57.53.41	208	57.55.36	231	57.56.96	193, 196
57.49.21	274	57.53.42	208	57.55.37	231	57.56.97	193, 196
57.49.30	171	57.53.43	208	57.55.38	231	57.56.98	195
57.49.31	171	57.53.45	208	57.55.39	231	57.57.33	227
57.49.32	171	57.53.46	208	57.55.40	231	57.57.34	227
57.50.01	276	57.53.47	208	57.55.41	231	57.57.35	227
57.50.24	274	57.53.50	209	57.55.50	228	57.57.36	227
57.50.25	274	57.53.51	209	57.55.75	228	57.57.37	227
57.50.26	274	57.53.52	209	57.55.80	228	57.57.38	227

**E06**
Numerischer Index
Numerical Index
Indice numérico
Index numérique
Indice numerico

57.57.39	227	57.57.99	225	57.59.52	217-219	57.59.96	220
57.57.40	226	57.58.01	212	57.59.53	217-219	57.59.97	220
57.57.41	226	57.58.02	213	57.59.54	217-219	57.60.63	155
57.57.42	226	57.58.11	212	57.59.55	217-219	57.60.64	155
57.57.43	183, 226	57.58.12	213	57.59.56	220	57.60.65	155
57.57.44	183, 226	57.58.21	212, 213, 214	57.59.57	220	57.60.66	155
57.57.45	183, 226	57.58.22	214	57.59.58	220	57.60.67	155
57.57.46	226	57.58.31	214	57.59.59	220	57.60.68	155
57.57.47	226	57.58.32	214	57.59.60	220	57.60.69	155
57.57.50	226	57.58.35	155	57.59.61	220	57.60.83	156
57.57.51	226	57.58.36	155	57.59.62	220	57.60.84	156
57.57.52	154	57.58.37	155	57.59.63	146, 148, 150, 156, 197, 200, 205, 221	57.60.85	156
57.57.53	227	57.58.38	155	57.59.64	146, 148, 150, 156, 197, 200, 205, 221	57.60.86	156
57.57.54	226, 227	57.58.39	155	57.59.65	146, 148, 150, 156, 197, 200, 205, 221	57.60.87	156
57.57.55	226, 227	57.58.40	155	57.59.66	146, 148, 150, 156, 197, 200, 205, 221	57.60.88	156
57.57.56	226, 227	57.58.42	155	57.59.67	146, 148, 150, 156, 197, 200, 205, 221	57.60.89	156
57.57.57	226, 227	57.58.44	155	57.59.68	146, 148, 150, 156, 197, 200, 205, 221	57.62.00	203
57.57.58	226, 227	57.58.51	214	57.59.69	146, 148, 150, 156, 197, 200, 205, 221	57.62.05	203, 204
57.57.59	227	57.58.52	214	57.59.79	150, 197, 200, 203, 205, 221	57.62.10	204
57.57.60	227	57.58.55	147	57.59.80	150, 197, 200, 203, 205, 221	57.62.15	204
57.57.61	227	57.58.56	147	57.59.81	150, 197, 200, 203, 205, 221	57.62.16	204
57.57.62	154	57.58.57	149	57.59.82	150, 197, 200, 203, 205, 221	58.16.45	78
57.57.65	198	57.58.58	149	57.59.83	150, 197, 200, 203, 205, 221	58.16.48	78
57.57.66	198	57.58.59	146	57.59.84	150, 197, 200, 203, 205, 221	58.19.20	26
57.57.67	198, 199, 225	57.58.60	146	57.59.85	150, 197, 200, 203, 205, 221	58.19.21	26
57.57.68	198, 199, 225	57.58.62	148	57.59.93	220	58.19.30	26
57.57.69	198, 199, 225	57.58.63	148	57.59.94	220	58.19.31	26
57.57.70	198, 199, 225	57.58.64	212, 213, 215	57.59.95	220	58.19.40	78
57.57.71	198, 199, 225	57.58.65	215			58.19.45	78
57.57.72	198, 199, 225	57.58.66	215			58.20.60	48
57.57.73	198, 199, 225	57.58.74	215			58.20.64	48
57.57.74	198, 199, 225	57.58.80	215			58.20.70	26
57.57.75	198, 199, 225	57.58.81	215			58.20.71	26
57.57.76	199, 225	57.58.82	215			58.24.15	83
57.57.77	198, 199, 225	57.58.85	216			58.24.16	83
57.57.78	198, 199, 225	57.58.86	216			58.24.17	83
57.57.79	198, 199, 225	57.58.87	197, 200, 207, 221			58.24.18	83
57.57.80	198, 199, 225	57.58.88	217			58.24.19	83
57.57.88	216, 219	57.58.89	217			58.24.20	83
57.57.89	216, 219	57.58.90	215			58.24.21	83
57.57.90	216, 219	57.58.91	215			58.24.22	83
57.57.91	216, 219	57.58.94	218			58.24.23	83
57.57.92	216, 219	57.58.95	218			58.24.24	83
57.57.93	216, 219	57.58.97	224			58.24.25	83
57.57.94	216, 219	57.58.98	224			58.24.26	83
57.57.95	216, 219	57.58.99	224			58.24.30	83
57.57.96	216, 219	57.59.43	175			58.24.31	83
57.57.97	216, 219	57.59.51	217-219			58.30.01	298
57.57.99	194, 199					58.30.10	295



E06

Numerischer Index
Numerical Index
Indice numérico
Index numérique
Indice numerico

58.30.15	287	58.33.24	166, 289	59.20.10	49	62.62.05	258
58.30.16	295	58.33.25	290	59.20.14	49	62.62.51	258
58.30.17	295	58.33.26	290	59.20.16	49	62.62.52	258
58.30.18	295	58.33.27	290	59.20.18	49	62.62.53	258
58.30.26	281	58.33.28	174	59.20.20	27	63.69.96	320
58.30.31	275	58.33.29	174	59.20.21	27	66.10.20	176
58.30.32	275	58.33.41	298	59.20.23	27	66.38.10	257
58.30.35	275	58.33.42	298	59.20.30	27	66.38.21	257
58.30.36	275	58.33.43	298	59.20.31	27	66.38.22	257
58.30.55	300	58.33.44	298	59.20.40	78	66.38.31	257
58.30.61	300	58.33.60	185	59.20.45	78	66.38.32	257
58.30.62	300	58.33.62	185	59.23.10	50	67.21.30	280
58.30.63	300	58.33.65	292	59.23.14	50	67.40.20	110
58.30.65	300	58.33.66	293	59.23.20	28	68.01.41	91
58.32.03	281	58.33.67	292	59.23.21	28	68.01.42	91
58.32.04	281	58.33.68	293	59.23.30	28	68.01.43	91
58.32.13	282	58.33.70	292	59.23.31	28	68.01.44	91
58.32.18	282	58.33.71	293	59.23.40	28	68.01.45	91
58.32.21	288	58.33.72	292	59.23.41	28	68.01.46	91
58.32.22	288	58.33.73	293	59.23.42	78	68.01.47	91
58.32.23	288	58.33.75	292	59.23.45	78	78.41.20	304
58.32.32	297	58.33.76	293	59.24.10	49	78.41.21	304, 305
58.32.33	297	58.33.80	292	59.24.14	49	78.41.22	304, 305
58.32.50	302	58.36.02	290	59.44.03	52	78.41.23	304, 306
58.32.51	302	58.36.03	290	59.44.05	52	78.41.24	306
58.32.54	296	58.44.05	52	59.44.13	52	88.00.20	64
58.32.55	296	58.45.40	161, 174	59.44.15	52	88.00.21	64
58.32.56	296	58.46.40	22	59.44.43	53	88.00.22	64
58.32.57	288	58.46.42	22	59.44.45	53	88.00.23	64
58.32.58	288	58.46.43	22	59.44.50	50	88.00.24	64
58.32.59	288	58.47.01	166, 174, 285	59.44.73	52	88.00.27	64
58.32.60	288	58.47.02	166, 174, 285	59.44.75	52	88.00.40	64
58.32.61	288	58.47.03	166, 285	59.45.15	46	88.07.02	58
58.32.62	301	58.47.04	166, 285	59.45.18	46	88.07.03	58
58.32.63	282	59.16.20	27	59.45.21	46	88.07.07	58
58.32.64	282	59.16.21	27	59.46.15	46	88.07.08	58
58.32.65	282	59.18.10	49	59.46.18	46	88.07.12	58
58.32.67	301	59.18.14	49	59.46.21	46	88.07.13	58
58.32.68	301	59.18.16	47	59.47.15	46	88.07.14	58
58.33.01	299	59.19.10	45	59.47.18	46	88.07.15	58
58.33.02	299	59.19.11	45	59.47.21	46	88.07.20	59
58.33.05	299	59.19.12	45	59.48.15	46	88.07.23	59
58.33.06	299	59.19.13	45	59.48.18	46	88.07.56	59
58.33.09	302	59.19.14	45	59.48.21	46	88.07.57	59
58.33.17	296	59.19.15	45	59.49.15	47	88.07.58	59
58.33.18	297	59.19.16	45	59.49.18	47	88.07.81	58
58.33.19	297	59.19.17	45	59.49.21	47	88.07.82	58
58.33.22	166, 289	59.19.18	45	62.62.03	258	88.07.83	58
58.33.23	289	59.19.19	45	62.62.04	258	88.07.91	59

**E06**

Numerischer Index
Numerical Index
Indice numérico
Index numérique
Indice numerico

88.07.92	59	88.70.39	62	93.02.01	316	93.03.38	313
88.07.93	59	88.90.25	170	93.02.03	316	93.03.40	318
88.08.01	60	88.90.40	185	93.02.05	316	93.03.50	316
88.08.02	60	91.06.35	183	93.02.07	316	93.03.66	316
88.08.03	60	91.75.15	190	93.02.09	316	93.03.68	316
88.08.04	60	91.75.20	190	93.02.11	316	93.04.00	313
88.08.05	60	93.00.00	319	93.02.13	316	93.04.01	316
88.08.06	60	93.00.02	319	93.02.17	316	93.04.03	316
88.08.07	60	93.00.04	319	93.02.19	316	93.04.05	313
88.08.08	60	93.00.10	319	93.02.20	318	93.04.07	316
88.08.09	60	93.00.15	319	93.02.21	316	93.04.09	316
88.08.10	60	93.00.20	314	93.02.22	318	93.04.10	313
88.08.11	60	93.00.22	311	93.02.23	316	93.04.21	316
88.08.12	60	93.00.25	312	93.02.24	318	93.04.23	316
88.08.13	60	93.00.30	313	93.02.25	316	93.05.03	316
88.08.14	60	93.00.32	313	93.02.30	316	93.05.07	316
88.08.15	60	93.00.34	313	93.02.31	317	93.05.09	316
88.08.71	61	93.00.40	315	93.02.32	317	93.05.11	316
88.08.72	61	93.00.42	315	93.02.33	317	93.05.13	316
88.08.73	61	93.00.44	315	93.02.35	317	93.06.01	316
88.08.76	61	93.00.46	315	93.02.37	317	93.06.03	316
88.08.77	61	93.00.48	315	93.02.39	317	93.06.07	316
88.08.81	61	93.00.50	315	93.02.41	317	93.06.08	318
88.08.82	61	93.00.52	315	93.02.43	317	93.06.09	316
88.08.91	61	93.00.54	315	93.02.45	316	93.06.11	316
88.08.92	61	93.00.55	315	93.02.47	318	93.06.13	316
88.08.93	61	93.00.56	315	93.02.49	318	93.06.30	317
88.12.05	63	93.00.60	318	93.02.52	316	93.07.03	316
88.12.06	63	93.00.70	315	93.02.54	316	93.07.05	316
88.12.07	63	93.00.72	315	93.02.66	316	93.07.07	316
88.12.08	63	93.00.74	315	93.02.68	316	93.07.08	316
88.17.05	62	93.00.76	315	93.03.01	316	93.07.09	316
88.17.06	62	93.00.78	315	93.03.03	316	203.02.14	10
88.17.07	62	93.00.80	320	93.03.05	316	203.02.16	10
88.17.08	62	93.00.83	320	93.03.07	316	203.03.14	10
88.20.05	62	93.00.85	320	93.03.08	316	203.03.16	10
88.20.06	62	93.01.01	316	93.03.09	316	203.04.14	11
88.20.07	62	93.01.03	316	93.03.10	316	203.05.14	11
88.20.08	62	93.01.05	316	93.03.11	316	203.06.14	11
88.23.03	63	93.01.07	316	93.03.13	316	203.06.16	11
88.23.07	63	93.01.09	316	93.03.15	316	203.07.14	11
88.23.12	63	93.01.11	316	93.03.17	316	203.50.14	13
88.24.03	63	93.01.13	316	93.03.19	316	203.50.17	13
88.24.07	63	93.01.15	313	93.03.20	316	203.50.64	13
88.24.12	63	93.01.17	318	93.03.21	317	203.50.67	13
88.70.05	63	93.01.19	318	93.03.22	317	203.51.14	13
88.70.06	63	93.01.20	316	93.03.23	317	203.51.17	13
88.70.16	63	93.01.22	316	93.03.35	317	203.51.64	13
88.70.38	62	93.01.23	316	93.03.37	313	203.51.67	13



Numerischer Index
Numerical Index
Indice numérico
Index numérique
Indice numerico

E06

204.13.12	14	213.51.17	13
204.13.62	14	214.13.12	14
204.24.14	15	214.32.11	15
204.24.64	15	214.32.14	16
204.25.14	15	214.32.18	16
204.25.64	15	214.32.20	16
204.32.11	15	214.33.11	15
204.32.14	16	214.33.14	16
204.32.18	16	214.33.18	16
204.32.20	16	214.33.20	16
204.32.61	15	214.34.14	17
204.32.64	16	214.34.18	17
204.32.68	16	214.34.20	17
204.32.70	16	214.35.14	17
204.33.11	15	214.35.18	17
204.33.14	16	214.35.20	17
204.33.18	16	214.67.12	18
204.33.20	16	214.67.16	18
204.33.61	15	214.67.18	18
204.33.64	16	224.13.62	14
204.33.68	16	224.67.66	18
204.33.70	16	224.67.68	18
204.34.14	17	225.15.32	19
204.34.18	17	225.15.34	19
204.34.20	17	225.15.36	19
204.34.64	17	225.15.42	20
204.34.68	17	225.15.44	20
204.34.70	17	225.15.46	20
204.35.14	17	225.19.25	25
204.35.18	17	225.19.45	25
204.35.20	17	225.19.60	25
204.35.64	17	255.15.32	19
204.35.68	17	255.15.34	19
204.35.70	17	255.15.36	19
204.67.12	18	255.15.42	20
204.67.16	18	255.15.44	20
204.67.18	18	255.15.46	20
205.15.74	20	905.71.04	184
205.18.70	21	905.72.00	204
205.18.71	21	905.72.01	204
213.02.14	10	905.72.02	204
213.03.14	10	909.81.01	80
213.04.14	11		
213.05.14	11		
213.06.14	11		
213.07.14	11		
213.50.14	13		
213.50.17	13		
213.51.14	13		



||| CMF

||| SURGICAL

||| NEURO+SPINE



Medicon eG

Gänsäcker 15
D-78532 Tuttlingen

P. O. Box 44 55
D-78509 Tuttlingen

Tel.: +49 (0) 74 62 / 20 09-0
Fax: +49 (0) 74 62 / 20 09-50

E-Mail: sales@medicon.de
Internet: www.medicon.de

Germany

450.00.59

medicon[®]

||| NEURO+SPINE

